



for a greener tomorrow

FACTORY AUTOMATION

COMPACT PLC FAMILY

MELSEC PLC



- 18 million compact PLCs worldwide
- Over 35 years experience
- Positioning/ motion control
- Networking
- Remote maintenance
- Security

Global impact of Mitsubishi Electric



Through Mitsubishi Electric's vision, "Changes for the Better" are possible for a brighter future.

Changes for the Better

We bring together the best minds to create the best technologies. At Mitsubishi Electric, we understand that technology is the driving force of change in our lives. By bringing greater comfort to daily life, maximising the efficiency of businesses and keeping things running across society, we integrate technology and innovation to bring changes for the better.

Mitsubishi Electric is involved in many areas including the following

Energy and electric systems

A wide range of power and electrical products from generators to large-scale displays.

Electronic devices

A wide portfolio of cutting-edge semiconductor devices for systems and products.

Home appliance

Dependable consumer products like air conditioners and home entertainment systems.

Information and communication systems

Commercial and consumer-centric equipment, products and systems.

Industrial automation systems

Maximising productivity and efficiency with cutting-edge automation technology.

Contents

Global leader	4	
What makes a world leading PLC?	5	
Range overview	6	
iQ-F – the next level of industry	7	
FX3U/FX3UC – a perfect PLC concept	8	
FX3G/FX3GC/FX3GE – customized control	9	
FX3S – new possibilities	10	
Programming and software	11	
Networking	12	
Analog solutions	13	
Drive control solutions	14	
Visualization solutions	15	

Section 2: Technical Informations

Global leader



The MELSEC iQ-F series is the fourth generation compact programmable controllers of Mitsubishi Electric. It offers outstanding performance, superior drive control and an intuitive programming environment.

18 million FX

The FX Family of PLCs is the PLC of choice across the world, industries and applications. Mitsubishi Electric has always worked closely with its customers to design the PLC that they want for their applications. The manufacturing and use of 18 million FX CPUs is a demonstration that this close working relationship has delivered quality, reliability and the product that customers want.

Over 35 years

The FX Family of PLCs has been an important part of control engineering for over 35 years. Throughout its history, the product has evolved from the original F series into today's current iQ-F series.

The FX Family has proven to be highly reliable and it consistently improves its compatibility with previous PLC generations.

International acceptance

Shipping approvals such as ABS, Lloyds Register, DNV/GL, Bureau Veritas, NK, RINA, KR for example plus CE compliance for Low Voltage and EMC directives as well as manufacturing to Automotive industry quality levels, make the FX Family PLCs products to trust.

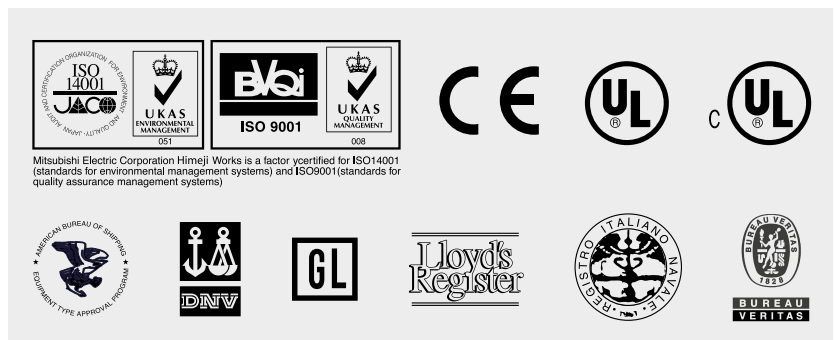

Mitsubishi Electric Corporation Himeji Works is a factor certified for ISO14001 (standards for environmental management systems) and ISO9001 (standards for quality assurance management systems)

What makes a world leading PLC range?

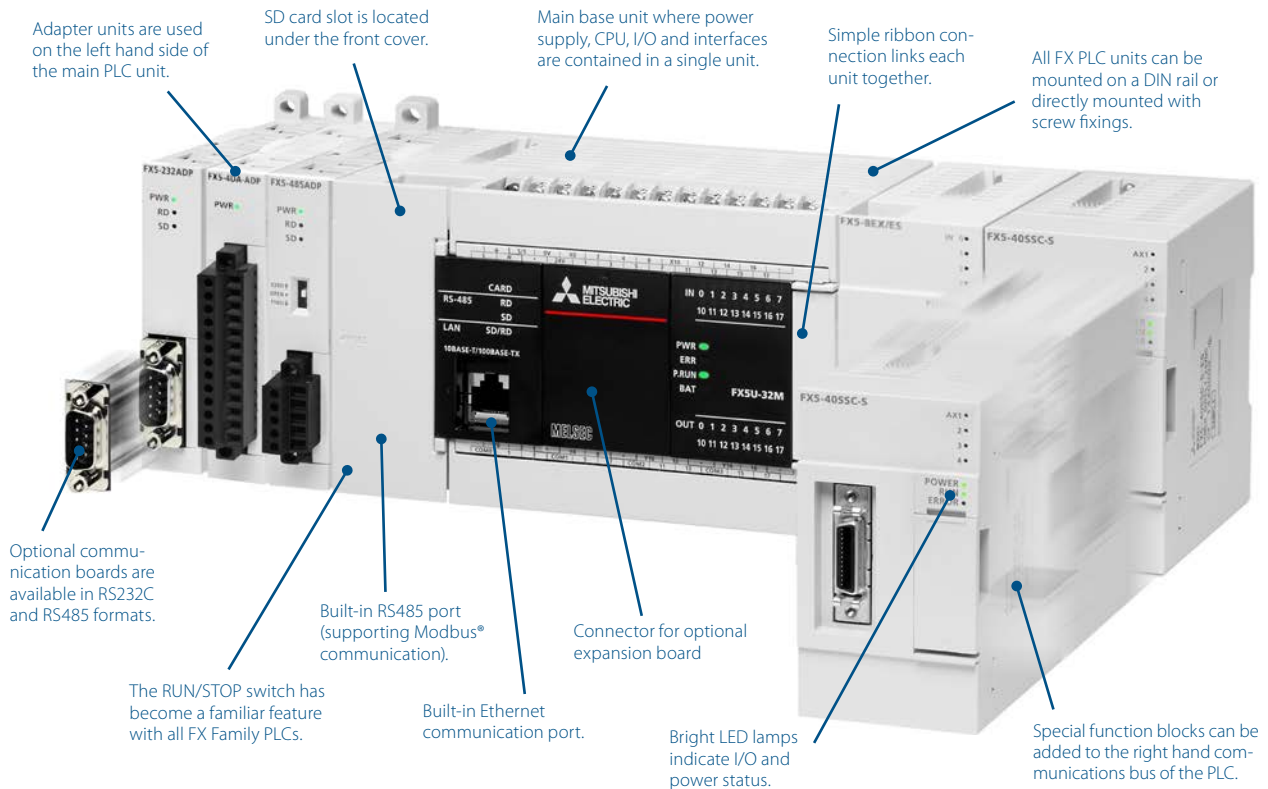

Ease of use

Control systems that require minimal setup and keep program development time short.

Affordable

A high performance to cost ratio makes economical design solutions for a diverse range of applications a reality.

These features combined with Mitsubishi Electric's legacy in quality and reliability ensure that the fourth generation of micro controllers will continue to be at the forefront of the compact PLC market and provide customers with a leading edge.

Flexible

A configurable design that permits open communication, large I/O handling, as well as precise positioning and analog control, creating systems that adapt to customer requirements.

Customer Confidence

With a design philosophy spanning more than a quarter century, a customer base spread across the globe, a host of industrial certifications and almost 16 million CPUs sold, the FX series continues to sustain its position as the compact PLC of choice.

The power to perform



The FX Family of PLCs builds on previous performance and capability, ensuring you have a comprehensive range of control and automation options to choose from.

A solution for every application

Micro PLCs have opened up a world of opportunities in Industrial Automation due to their small size and low cost. Now many applications benefit from enhanced performance, easier manufacturing, maintenance and greater reliability.

The FX Family has been a part of this revolution for over 35 years and has developed a range of products to suit most applications. The FX Family consists of four main ranges which are distinct and independent but compatible.

Depending on your application and control needs, you can choose from the small, economical standalone FX3S series over the powerful FX3G, FX3GC, FX3GE, FX3U and FX3UC series to the ultimate FX5U and FX5UC series.

With the FX Family there really is a solution to most applications.

MODEL	FX3S	FX3G	FX3GC	FX3GE	FX3U	FX3UC	FX5U	FX5UC
Power supply	100–240 V AC	100–240 V AC, 24 V DC	24 V DC	100–240 V AC, 24 V DC	100–240 V AC, 24 V DC	24 V DC	100–240 V AC, 24 V DC	24 V DC
Maximum I/O	30	256*	256*	256*	384**	384**	512***	512***
Digital I/O	Relay/Transistor	Relay/Transistor	Transistor	Relay/Transistor	Relay/Transistor	Transistor	Relay/Transistor	Transistor
Cycle period/ logical instruction	0.21 µs/logical instruction	0.21 µs or 0.42 µs/logical instruction	0.21 µs or 0.42 µs/logical instruction	0.21 µs or 0.42 µs /logical instruction	0.065 µs	0.065 µs	0.034 µs/logical instruction	0.034 µs/logical instruction
PLC program memory	4 k steps	32 k steps	32 k steps	32 k steps	64 k steps	64 k steps	64/128 ^① k steps	64/128 ^① k steps

Notes:

* When networked with CC-Link (Discrete I/O, maximum 128)

** When networked with CC-Link (Discrete I/O, maximum 256)

*** When networked with CC-Link/AnyWireASLINK (Discrete I/O, maximum 384)

① Scan time will increase when using the 128 k step mode on FX5.

iQ-F – the next level of industry



FX5U/FX5UC at a glance

FAST INSTRUCTION TIMES

Basic instructions: 0.034 μ s/
instruction (contact instruction)
Applied instructions: 0.034 μ s/
instruction (MOV instruction)

LARGE MEMORY

64,000/128,000* steps of built-in
program memory.

APPLICABLE STANDARDS

All products support EN and UL/cUL
standards. Various shipping approvals
are supported as well.

LARGE DEVICE MEMORY

Auxiliary relays	32,768 points
Timers	1024 points
Counters	1024 points
Data registers	8000 points
Link registers	32,768 points
File registers	32,768 points

* Scan time will increase when using the
128 k step mode on FX5.

FX5U – Top of the line

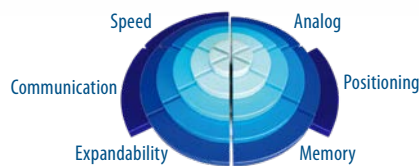

The FX5U is the latest and also the most powerful compact PLC in the FX Family. Mitsubishi Electric has given the compact controllers a huge performance boost, focusing on processing power, expansion, built-in functionality and positioning & motion functions.

- High-speed system bus
- Built-in high-speed processing and positioning
- Built-in analog inputs and analog output
- Built-in Ethernet port
- Webservice
- Modbus® function
- Enhanced security functions
- Battery-less
- FX5 and various FX3 extension modules connectable
- Controls up to 512 input/output points (up to 384 connected I/O and up to 512 remote I/O via CC-Link)

FX5UC – High-end in ultra-compact design

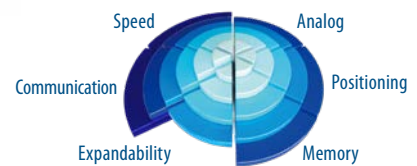

The FX5UC combines the powerful features of the FX5U in an even smaller housing. This ultra-compact PLC with 24 V DC power supply and connector-type transistor I/O is designed for space conscious applications and helps to downsize your system.

- Reduced size and wiring using connector- or spring clamp-type I/O
- High-speed system bus
- Built-in high-speed processing and positioning
- Built-in Ethernet port
- Webservice
- Modbus® function
- Enhanced security functions
- Battery-less
- FX5 and various FX3 extension modules connectable
- Controls up to 512 input/output points (up to 384 connected I/O and up to 512 remote I/O via CC-Link)

FX3U/FX3UC – a perfect PLC concept



FX3U – High performance

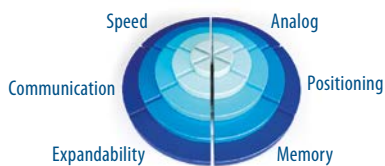

The FX3U is the original dual system-bus, high-speed, fully expandable compact PLC designed to seamlessly control communication, networking, analog, and positioning systems. With a maximum of 384 controllable local and networked I/O via CC-Link, the FX3U uses its power and flexibility to provide a solution for a variety of applications.

- 3rd generation compact PLC
- High efficiency with more speed, performance, memory, and new functions
- Built-in high-speed processing and positioning
- The FX3U can control a maximum of 256 connected I/O, and up to 384 points with CC-Link remote I/O.

FX3UC – Slim fit

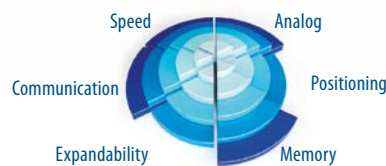

The FX3UC is an ultra-compact high-speed, fully expandable PLC. Based on 24 V DC power and using connector-type transistor I/O, the FX3UC is designed for space conscious and modular applications. Created inline with the FX3U series, the FX3UC incorporates such attributes as built-in high-speed I/O and the dual system-bus architecture, optimizing communication, networking, analog, and positioning control.

- 3rd generation super-compact PLC
- Reduced size and wiring using connector-type I/O
- Built-in high-speed processing and positioning
- Even with its ultra-compact size, the FX3UC can be expanded to locally control up to 256 I/O, and up to 384 points with CC-Link remote I/O.

FX3U/FX3UC at a glance

FAST INSTRUCTION TIMES

Basic instructions: 0.065 μ s/
instruction (contact instruction)
Applied instructions: 0.642 μ s/in-
struction (MOV instruction)

LARGE MEMORY

64,000 steps of built-in program
memory. Flash memory cassettes
with loader function are available.

APPLICABLE STANDARDS

All products support EN and UL/cUL
standards. Various shipping approvals
are supported as well.

LARGE DEVICE MEMORY

Auxiliary relays	7,680 points
Timers	512 points
Counters	235 points
Data registers	8,000 points
Extension registers	32,768 points
Extension file registers (with optional memory cassette)	32,768 points

FX3G/FX3GC/FX3GE – customized control



FX3G – Customized control

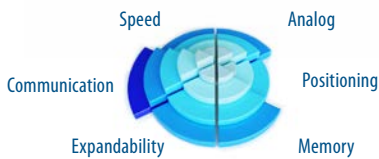

The FX3G is an introductory compact PLC and is an addition to the FX3 series, designed for simple yet performance-critical applications. Incorporating innovative FX3 series technology the customer is presented with a suite of benefits.

- 3rd generation compact PLC
- Highly flexible
- Dual system-bus architecture
- Control of up to 128 directly connected I/O, or up to 256 I/O with CC-Link remote I/O.

FX3GC – Super compact control

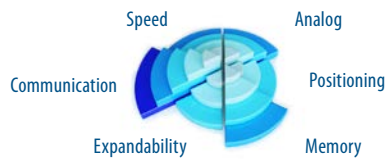

The FX3GC expands the FX3 series line up with a connector type PLC entry model. Having the same processing capability as the highly successful FX3G, this super compact product reduces installation space, wiring time and potential wiring faults.

- 3rd generation super-compact PLC
- Reduced size and wiring using connector-type I/O
- Dual system-bus architecture
- Control of up to 128 directly connected I/O, or up to 256 I/O with CC-Link remote I/O.

FX3GE – All-in-one standard

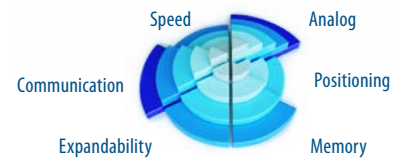

FX3GE adds built-in analog input/output and Ethernet connectivity on top of FX3G performance.

A great fit for many applications.

- 3rd generation, all-in-one PLC
- Highly flexible
- Dual system-bus architecture
- Control of up to 128 directly connected I/O, or up to 256 I/O with CC-Link remote I/O.

FX3G/FX3GC/FX3GE at a glance

INSTRUCTION TIMES

Basic instructions: 0.21 μ s/
instruction (contact instruction)
Applied instructions: 0.42 μ s/
instruction (MOV instruction)

LARGE MEMORY

32,000 steps of built-in program
memory. EEPROM memory cassettes
with loader function (FX3G/FX3GE).

APPLICABLE STANDARDS

All products support EN and UL/cUL
standards. Various shipping approvals
are supported as well. For FX3GC/
FX3GE shipping approvals please
consult your local Mitsubishi repre-
sentative.

LARGE DEVICE MEMORY

Auxiliary relays	7,680 points
Timers	320 points
Counters	235 points
Data registers	8,000 points
Extension registers	24,000 points
Extension file registers	24,000 points

FX3S – new possibilities



FX3S– Basic micro control



Besides a high cost performance ratio, the compact entry-level FX3S offers various expansion options.

FX3S makes it possible to utilize analog, Ethernet and Modbus® functions even in small-scale systems.

- Basic controller for general applications
- High performance with minimal size

Fit and forget

Typically FX3S applications are small, embedded control functions that are hidden away or unaccessible under normal maintenance activities. This is why the FX3S has been designed to be a robust low maintenance PLC. Features such as the maintenance free, 4000 step EEPROM memory and real time clock management all help to make the FX3S a self managing system, reducing the impact on the maintenance engineer.

Remote control

The FX3S has an additional range of BD expansion boards providing RS232, RS485, RS422 or Ethernet communications options. These can be used to connect and control various third party products such as bar code readers or panel printers.

FX3S at a glance

INSTRUCTION TIMES

Basic instructions: 0.21 μ s/
instruction (contact instruction)
Applied instructions: 0.5 μ s/
instruction (MOV instruction)

MEMORY SPECIFICATIONS

4,000 steps of built-in program
memory.
No battery.
No maintenance.

APPLICABLE STANDARDS

All products support EN and UL/
cUL standards. Please consult with
your local Mitsubishi representative
regarding FX3S shipping approvals.

DEVICE MEMORY SPECIFICATIONS

Auxiliary relays	1,536 points
Timers	138 points
Counters	67 points
Data registers	3,000 points
Extension file registers	2,000 points

Progressive software concepts

The Mitsubishi Electric FX PLC Family has a worldwide reputation for reliability, performance and ease of use. These key values have also been used to form Mitsubishi Electric's integrated software concept, MELSOFT.

Simple programming

The FX Family has a simple programming structure combining Basic and Applied instructions. The Basic instructions are common to all FX Family PLCs. Applied instructions provide the specialist control options such as data comparisons, PID and communications control, all of which are available on FX series. By the graded performance of each PLC series of the FX family, the number of available application instructions increases.

Productivity tools

Programming software for PLCs is constantly evolving. Users are placing more focus on reusable program code and function block concepts. This helps to reduce errors, reduce programming time and to help manage the whole programming process – increasing overall productivity.

Simple and intuitive

The key to any good software is that it is simple to use. Mitsubishi Electric's GX Works PLC programming packages have achieved this by using intuitive design.

GX Works3 offers also comprehensive help functions and an advanced communications layer, ensuring safe reliable communication to the target PLC.

Choose what you need

Mitsubishi Electric provides with GX Works2 IEC 61131-3 compliant programming, where programs in Instruction List, Ladder, Function Block, Structured Text or SFC formats can be

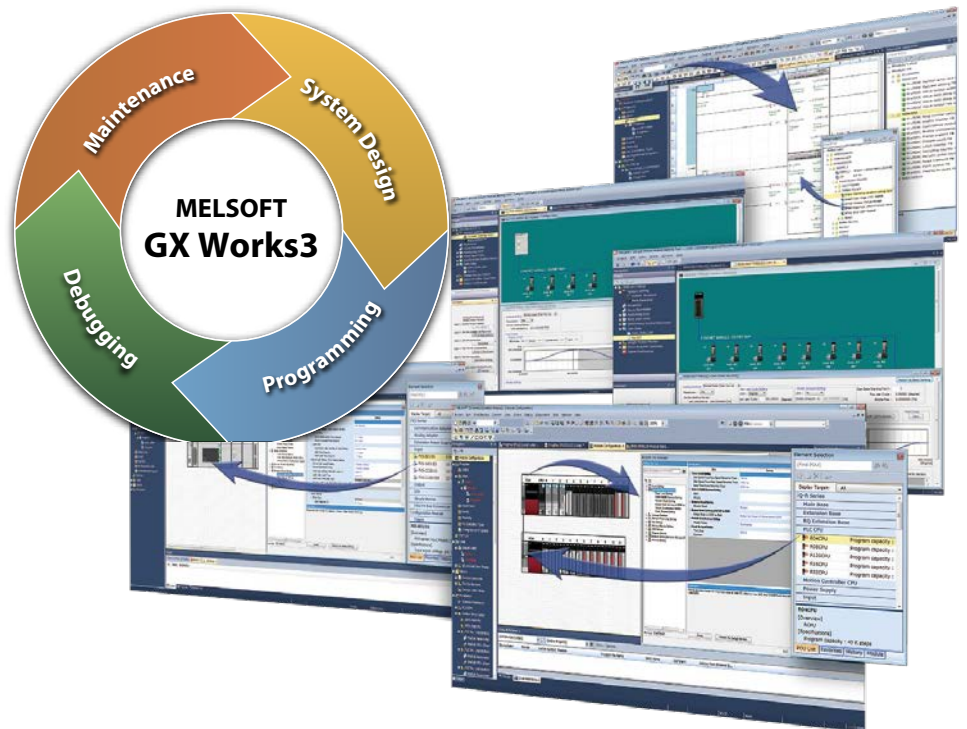

created. Using standard programming languages, like IEC 61131-3, on large programming projects can help users save costs by creating reusable PLC code and Function Blocks.

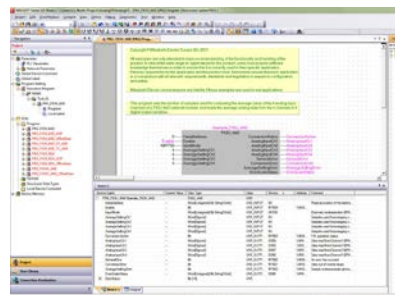

GX Works2 offers users the chance to program all Mitsubishi Electric MELSEC PLCs from a single package. However, for users who only need support for FX based systems there is GX Works2 FX.

For the new iQ-F and iQ-R series, Mitsubishi Electric offers the next level of PLC programming environment, GX Works3.

One step further with iQ Works

With the software suite iQ Works2 Mitsubishi Electric offers an integrated engineering environment. The intuitive user interface allows you to program and set up of the iQ-F and iQ-R series, including system and network configuration, the programming of the MELSEC System Q, the MELSEC L series and the FX family, the establishment of motion controllers and servos, the design of user interfaces for operator panels of the GOT family as well as the programming of robots with the RT ToolBox2 and the parameter setting for FREQROL inverters.

Networking and communication solutions

Applications are often required to integrate between each other across a factory, to report production or tracking data back for office based processing and in some cases be remotely monitored and maintained when the application is in an inaccessible location. The FX Family of PLCs has evolved to match this demand at all levels.

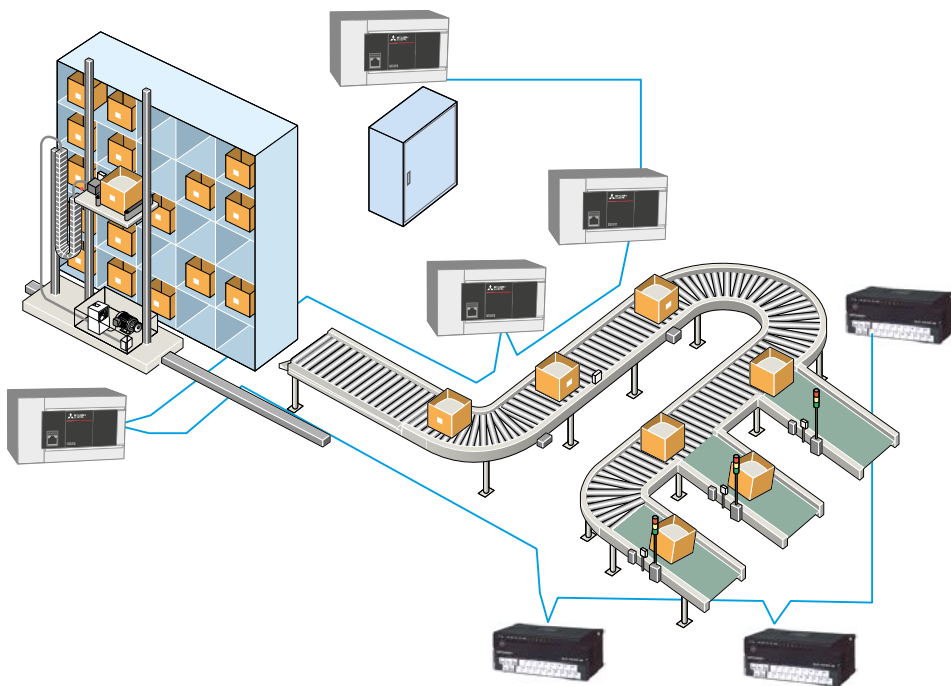

FX Family PLCs have a wide range of communications options.

Networks make sense

Networked solutions to complex applications often make the overall solution easier to achieve and more cost effective. For example a conveyor system integrated with a warehouse pick and place system may extend over many hundreds of meters, and by using a fieldbus, such as CC-Link, wiring, troubleshooting and maintenance can be dramatically reduced.

Remote maintenance

With communications technology it is possible to put PLC control in the most remote locations. Using a PLC connected to a telemetry solution, such as a GSM modem, allows the user to remotely monitor and maintain the system. It can also allow the remote system to send alarm messages, warnings or general status information back to the user's central data processing centre.

Easy communications

Today's FX Family of PLCs share a basic communication concept where additional RS232, RS422 or RS485 communications boards can be added to the main base unit without increasing the required cabinet space. These can then be used for communication to various third party devices like bar code readers, printers and modems.

FX Family PLCs have a wider range of communications modules. These include options for connection to open and bespoke networks such as Ethernet, Profibus DP, CC-Link, DeviceNet™, CANopen or Modbus® for example.

The built-in Ethernet port of the FX5U and FX5UC base units allows for the



Example of remote pumping station.

connection to a personal computer or communication to other devices. The FX5U and FX5UC additionally offer an integrated RS485 port that allows to connect up to 16 Mitsubishi inverters or using Modbus® communication up to 32 devices like temperature controllers etc.

Analog solutions

Analog control is one of the most important areas for any automation system. Critically for users the concern is to match the performance demanded by the application to the available solutions in a cost effective way.

Where is analog used?

Analog control is widely used. In simple terms it allows a variable signal to be used to control items such as a motor's speed or to sense inputs such as fluid levels.

Digital to analog (D-A) control

Here a digital PLC value is output as an analog signal. It can be used, for example, to send a speed command to an inverter which in turn causes the motor to increase or decrease speed.

Analog to digital (A-D) control

In this type of control a variable signal is sent to a PLC where it is converted in to a direct digital value. An example of this could be the measurement of the level of a liquid in a storage tank so that the exact amount of stored liquid can be controlled by the PLC.

Temperature control

Temperature control is the third type of analog control. An example of use could be where the temperature of a furnace is measured and compared by the PLC against a set range. Additional heating or cooling can then be applied to maintain a constant temperature.

Example of temperature control.

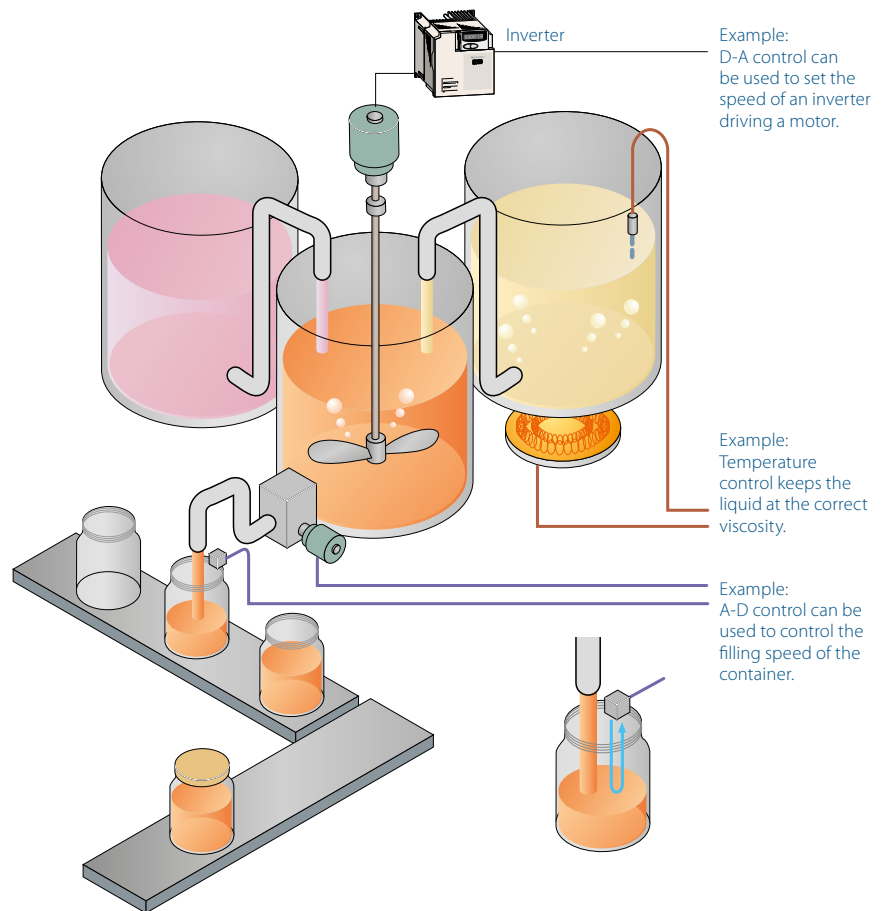

Analog solutions are an important part of control engineering and can be used to simplify and accurately control actions happening in the production environment.

Solutions to choose from

The FX Family offers a wide range of analog solutions from 1 and 2 channel BD boards for FX3G up to 8 channel input blocks like the FX5-8AD where temperature, voltage and current input can be mixed on the same block. FX analog blocks also come in a range of resolutions from 8 bit up to 16 bit signal processing.

The FX3GE and FX5U base units are equipped with 2 analog input channels and 1 analog output channel.

With this range of choice and flexibility it is sure that there will be a solution here for most applications.

Drive control solutions

Using simple positioning solutions can help increase the accuracy of the work process, reduce waste and rework as well as provide a higher quality of production.

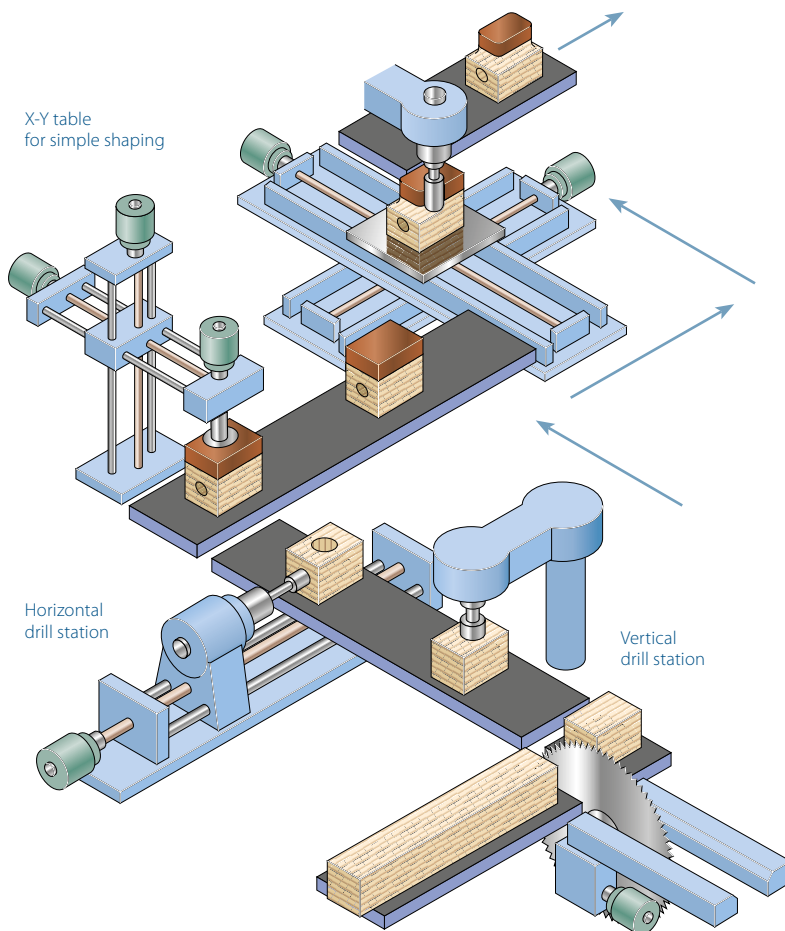

Simple positioning solutions can be effectively managed within a standard FX PLC.

Typical applications

Simple positioning applications typically involve independently controlled operational axis and can sometimes have many requirements. In the example of an X-Y table, a relative position is achieved by driving each axis until its target position is achieved, regardless of what happens with the other axis. There are two main elements to achieve this type of positioning control.

Pulse train outputs

A stream of output pulses can be used as a drive signal to a line driver, stepper motor or servo amplifier, which then causes the connected motor to perform the positioning activity.

The larger the range of output pulse frequencies available means greater speed and/or accuracy is achievable. For example, if a stepper motor with a larger number of steps is used, the travel distance per step can be reduced, resulting in an increased system accuracy.

High-speed counter input

When a motor is being driven, its relative position can be controlled by counting the number of output pulses.

However, for a more accurate process, reading the actual position from an encoder feedback directly into a high-speed counter is preferred. This helps to overcome issues of backlash and slippage as the actual position is measured and not assumed.

Positioning built in as standard

FX PLCs come with high-speed counters (up to 200 kpps) and pulse train outputs (up to 200 kpps) as standard. The high-speed counters can be configured in single pulse train inputs. The high-speed counters can be configured in a single or two phase input. Pulse train outputs can be configured to provide continuous pulse streams at different frequencies or a set quantity of pulses at a single frequency.

There are also optional Simple Motion controllers, high-speed counter modules and positioning modules available for high-precision positioning applications.

Example of conveyor belt control.



Visualization solutions

An increasingly important area of any automation solution is the reporting and display of operational information. This data enables operators, maintenance teams and business managers to make informed decisions in the best interests of the business.



In the food industry hygiene is very important.

The right tool for the right job

For maximum efficiency, each user requires access to information at their work place in a form that highlights the important data for them first. This means a range of different tools are required. As an example, here are three possible scenarios.

The machine operator

Machines often have a lot of manufacturing debris around or are subject to hygienic cleaning as in the food industry. Any display located in this environment would need to have a high Ingress Protection (IP) rating, indicating a high degree of waterproofness.



The FX3U-7DM can be directly mounted within the PLC (FX3U) or mounted on the front cabinet.

It may also be a benefit to the operator to have a large and clear display to reduce the chances for error from mis-reading, due to poor light or small fonts being used. It is also recognized that the use of graphics also reduces the chances for reading errors with complex data.

The maintenance team

The critical information for a maintenance engineer is the error and diagnostic data within the PLC as this is used to diagnose any process problems. However, additional information regarding the operational "hours run" or cycles processed, which could be called soft information as it is calculated on operational parameters, could allow the maintenance engineer to predict possible failure and arrange preventative maintenance.

Access to this data could be through the machine operator's terminal, across a network or through a dedicated display mounted inside or on the control cabinet itself.

The business manager

In a production controllers office it would be better to display information through a network to their existing desktop PC. In this application a piece of software such as an OPC/OPC-UA server/client, a Java applet, an Active X control or a SCADA system would allow lots of data from lots of sources to be displayed in a clear and concise way giving the production controller the overview of the business operation that they need.

Data the way you want it

Mitsubishi Electric offers a wide range of visualization solutions from simple data displays such as the FX3U-7DM, advanced Graphic Operator Terminals like the GOT series, and a wide choice of software solutions from the MELSOFT software suite.

This powerful combination of hardware and software means there is a cost effective solution for most applications.

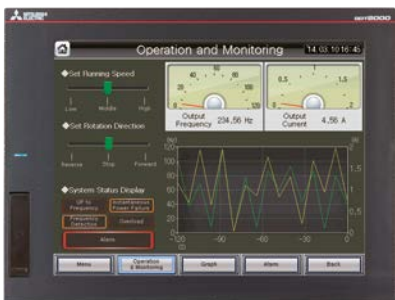

The GOT is a typical HMI

Where have FX PLCs been used?



Sanitation management on Eurostar rollingstock.

Customer applications with FX PLCs have been wide spread from critical applications in pharmaceutical industries to sublime applications in the leisure industry. With its high product quality, the FX PLC Family still remains the PLC of choice for many machine and plant builders as it is flexible, compact and easy to use, which is why it is so often used.

Here are just a few examples of applications that customers have completed in the past:

- Agriculture
 - Plant watering systems
 - Plant handling systems
 - Saw mill (wood)
- Building management
 - Smoke detection monitoring
 - Ventilation and temperature control
 - Lift (elevator) control
 - Automated revolving doors
 - Telephone management
 - Energy management
 - Swimming pool management
- Construction
 - Steel bridge manufacturing
 - Tunnel boring systems

- Food and drink
 - Bread manufacture (mixing/baking)
 - Food processing (washing/sorting/slicing/packaging)
- Leisure
 - Multiplex cinema projection
 - Animated mechatronics (museums/theme parks)
- Medical
 - Respiration machine testing
 - Sterilization
- Pharmaceutical/chemical
 - Dosing control
 - Pollution measurement systems
 - Cryogenic freezing
 - Gas chromatography
 - Packaging
- Plastics
 - Plastic welding systems
 - Energy management systems for injection molding machines
 - Loading/unloading machines
 - Blow molding test machines
 - Injection molding machines
- Printing
- Textiles
- Transportation
 - Sanitation on passenger ships
 - Sanitation on rail rolling stock
 - Fire tender, pump management
 - Waste disposal truck management
- Utilities
 - Waste water treatment
 - Fresh water pumping

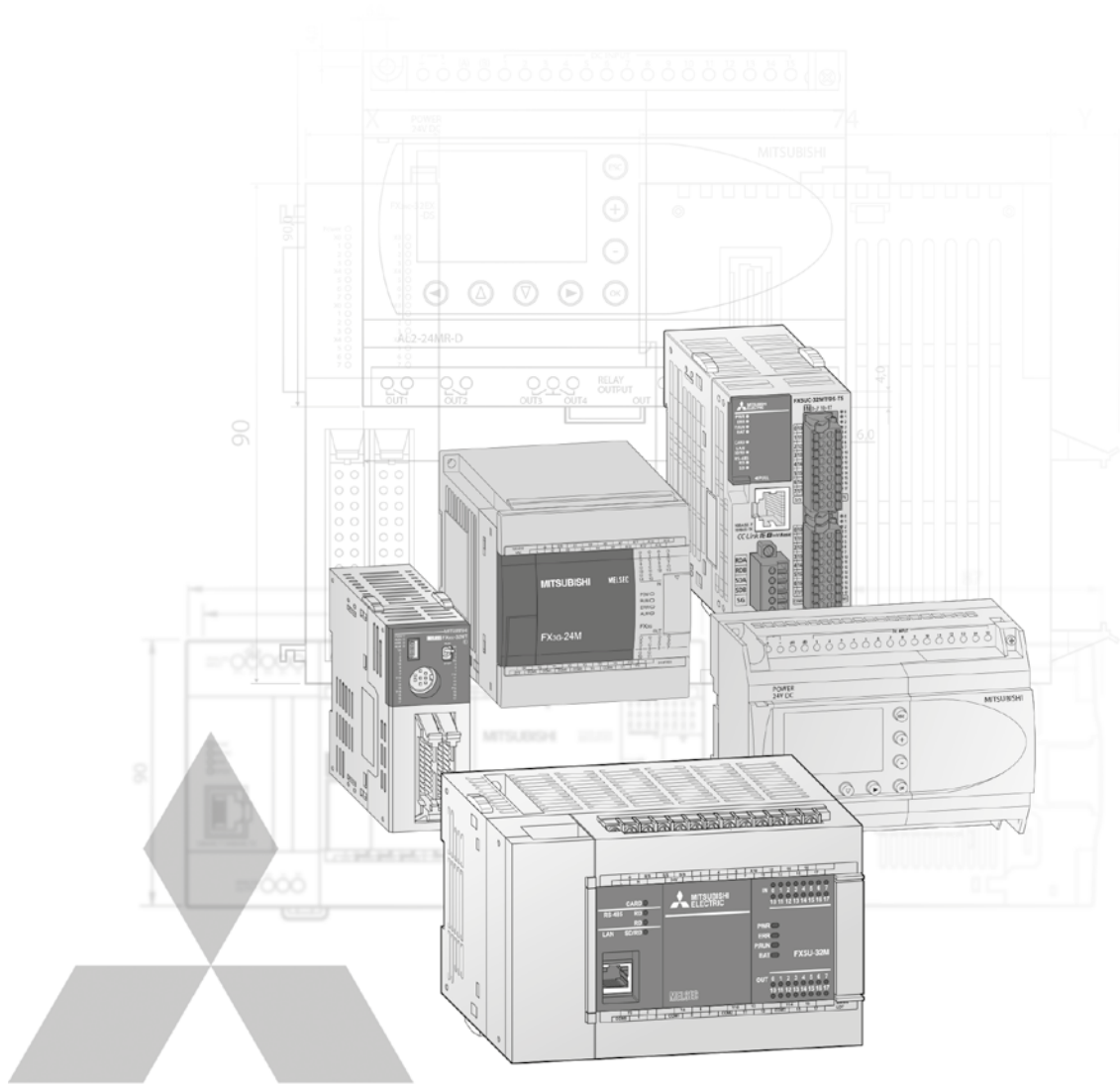

Technical Information Section

Further publications within the industrial automation range

Brochures

Modular PLC Family

Product catalogues for programmable logic controllers and accessories for the MELSEC iQ-R series/System Q/L series

HMI Family

Product catalogue for operator terminals, supervision software and accessories

FR Family

Product catalogue for frequency inverters and accessories

MR Family

Product catalogue for servo amplifiers and servo motors as well as motion controller and accessories

Robots Family

Product catalogue for industrial robots and accessories

LVS Family

Product catalogue for low voltage switchgears, magnetic contactors and circuit breakers

Automation Book

Overview on all Mitsubishi Electric automation products, like frequency inverters, servo/motion, robots etc.

More information?

This product catalogue is designed to give an overview of the extensive range FX Family of MELSEC PLCs. If you cannot find the information you require in this catalogue, there are a number of ways you can get further details on configuration and technical issues, pricing and availability.

For technical issues visit the <https://eu3a.mitsubishielectric.com> website. Our website provides a simple and fast way of accessing further technical data and up to the minute details on our products and services. Manuals and catalogues are available in several different languages and can be downloaded for free.

For technical, configuration, pricing and availability issues contact our distributors and partners. Mitsubishi Electric partners and distributors are only too happy to help answer your technical questions or help with configuration building. For a list of Mitsubishi Electric partners please see the back of this catalogue or alternatively take a look at the "contact us" section of our website <https://eu3a.mitsubishielectric.com>.

About this technical catalogue

This catalogue is a guide to the range of products available. For detailed configuration rules, system building, installation and configuration the associated product manuals must be read. You must satisfy yourself that any system you design with the products in this catalogue is fit for purpose, meets your requires and conforms to the product configuration rules as defined in the product manuals.

Specifications are subject to change without notice. All trademarks acknowledged.

© Mitsubishi Electric Europe B.V., Factory Automation - European Business Group

The products of Mitsubishi Electric Europe B.V., that are listed and described in this document, are neither subject to approval for export nor subject to the Dual-Use List.

1 Introduction and configuration

◆ Product overview MELSEC iQ-F	4
◆ Product overview MELSEC-F	5
◆ FX series selection guide	6
◆ Components for an FX PLC system	7
◆ FX series configuration	8
◆ Calculation of the power consumption	18
◆ MELSEC iQ-F built-in functions	19
◆ MELSEC-F built-in functions	29

2 MELSEC FX base units

◆ FX5U series	30
◆ FX5UC series	33
◆ FX3S series	36
◆ FX3G series	39
◆ FX3GE series	41
◆ FX3GC series	43
◆ FX3U series	46
◆ FX3UC series	50

3 MELSEC FX I/O extension

◆ Powered extension units	53
◆ Unpowered extension modules	55

4 MELSEC FX special function modules

◆ Analog modules	59
◆ Temperature control modules	62
◆ Data logger module, high-speed counter modules	63
◆ Positioning modules	64
◆ Simple Motion modules	65
◆ Network modules	66
◆ Communications modules, interface modules	72
◆ Adapter boards, communications adapter	76
◆ Interface adapters	78

5 Accessories

◆ Expansion adapter, conversion modules	79
◆ Conversion adapter, memory cassettes	80
◆ External terminal blocks, cable and connection terminals	81
◆ Power supply units	82
◆ Memory card, backup batteries	83
◆ SD memory card, batteries, displays	84
◆ Cables	85

6 ALPHA controllers

◆ Base units	86
◆ Extension units and accessories	90

7 Dimensions

◆ Base units	91
◆ Extension units	94
◆ Special function modules	97
◆ Accessories	101
◆ ALPHA series	103

8 Software & programming

◆ Programming software	104
Approvals	109
Index	112

MELSEC iQ-F series

The next generation of FX controllers

Designed on the concepts of outstanding performance, superior drive control and user centric programming, Mitsubishi's MELSEC-F series has been reborn as the MELSEC iQ-F series. From stand alone use to networked system applications, the MELSEC iQ-F series brings your business to the next level of industry.

MELSEC iQ-F

FX5U

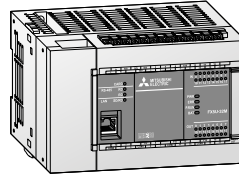

		32 I/O		64 I/O		80 I/O	
Power supply		AC	DC	AC	DC	AC	DC
CPU module	①	FX5U-32MR/ES	FX5U-32MR/DS	FX5U-64MR/ES	FX5U-64MR/DS	FX5U-80MR/ES	FX5U-80MR/DS
	②	FX5U-32MT/ES	FX5U-32MT/DS	FX5U-64MT/ES	FX5U-64MT/DS	FX5U-80MT/ES	FX5U-80MT/DS
	③	FX5U-32MT/ESS	FX5U-32MT/DSS	FX5U-64MT/ESS	FX5U-64MT/DSS	FX5U-80MT/ESS	FX5U-80MT/DSS
DC input type		Sink/source		Sink/source		Sink/source	
I/O points		Up to 384 local, up to 512 incl. network I/O's		Up to 384 local, up to 512 incl. network I/O's		Up to 384 local, up to 512 incl. network I/O's	
Program size	K step	64/128*		64/128*		64/128*	
Engineering environment		GX Works3		GX Works3		GX Works3	
Built-in analog I/O		2 input channels (voltage) 1 output channel (voltage)		2 input channels (voltage) 1 output channel (voltage)		2 input channels (voltage) 1 output channel (voltage)	
Built-in Ethernet port		✓		✓		✓	

FX5UC

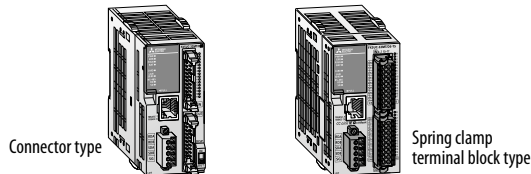

		32 I/O	64 I/O	96 I/O
Power supply		DC	DC	DC
CPU module	①	FX5UC-32MR/DS-TS [ⓐ]	—	—
	②	FX5UC-32MT/D [ⓑ] FX5UC-32MT/DS-TS [ⓐ]	FX5UC-64MT/D [ⓑ]	FX5UC-96MT/D [ⓑ]
	③	FX5UC-32MT/DSS [ⓒ] FX5UC-32MT/DSS-TS [ⓐ]	FX5UC-64MT/DSS [ⓒ]	FX5UC-96MT/DSS [ⓒ]
DC input type		① Sink ② Sink/source	① Sink ② Sink/source	① Sink ② Sink/source
I/O points		Up to 384 local, up to 512 incl. network I/O's	Up to 384 local, up to 512 incl. network I/O's	Up to 384 local, up to 512 incl. network I/O's
Program size	K step	64/128*	64/128*	64/128*
Engineering environment		GX Works3	GX Works3	GX Works3
Built-in analog I/O		—	—	—
Built-in Ethernet port		✓	✓	✓

Output type:

① Relay output ② Transistor output (sink) ③ Transistor output (source)

* Scan time will increase when using the 128 k step mode on FX5.

MELSEC-F series

The third generation of micro programmable controller, the FX3 series

The FX series is renowned for its speed, capacity, performance and extensive features. Integrated with many features including analog inputs/outputs, communication, Ethernet and positioning, the FX3 series realizes high-performance in many different applications.

MELSEC-F

	FX3S		FX3G		FX3GC	FX3GE		
	10–30 I/O		14–60 I/O		32 I/O	24–40 I/O		
Power supply	AC	DC	AC	DC	DC	AC	DC	
CPU module	①	FX3S-10MR/ES, FX3S-14MR/ES, FX3S-20MR/ES, FX3S-30MR/ES, FX3S-30MR/ES-2AD	FX3S-10MR/DS, FX3S-14MR/DS, FX3S-20MR/DS, FX3S-30MR/DS	FX3G-14MR/ES, FX3G-24MR/ES, FX3G-40MR/ES, FX3G-60MR/ES	FX3G-14MR/DS, FX3G-24MR/DS, FX3G-40MR/DS, FX3G-60MR/DS	—	FX3GE-24MR/ES, FX3GE-40MR/ES	FX3GE-24MR/DS, FX3GE-40MR/DS,
	②	FX3S-10MT/ES, FX3S-14MT/ES, FX3S-20MT/ES, FX3S-30MT/ES, FX3S-30MT/ES-2AD	FX3S-10MT/DS, FX3S-14MT/DS, FX3S-20MT/DS, FX3S-30MT/DS	FX3G-14MT/ES, FX3G-24MT/ES, FX3G-40MT/ES, FX3G-60MT/ES	FX3G-14MT/DS, FX3G-24MT/DS, FX3G-40MT/DS, FX3G-60MT/DS	FX3GC-32MT/D	FX3GE-24MT/ES, FX3GE-40MT/ES	FX3GE-24MT/DS, FX3GE-40MT/DS,
	③	FX3S-10MT/ESS, FX3S-14MT/ESS, FX3S-20MT/ESS, FX3S-30MT/ESS, FX3S-30MT/ES-2AD	FX3S-10MT/DSS, FX3S-14MT/DSS, FX3S-20MT/DSS, FX3S-30MT/DSS	FX3G-14MT/ESS, FX3G-24MT/ESS, FX3G-40MT/ES, FX3G-60MT/ESS	FX3G-14MT/DSS, FX3G-24MT/DSS, FX3G-40MT/DSS, FX3G-60MT/DSS	FX3GC-32MT/DSS	FX3GE-24MT/ESS, FX3GE-40MT/ESS	FX3GE-24MT/DSS, FX3GE-40MT/DSS
DC input type	Sink/source		Sink/source		Sink/source	Sink/source		
I/O points	Up to 30 local		Up to 128 local, up to 256 incl. network I/O's		Up to 128 local, up to 256 incl. network I/O's	Up to 128 local, up to 256 incl. network I/O's		
Program size	K step		4		32	32		
Engineering environment	GX Works2		GX Works2		GX Works2	GX Works2		
Built-in analog I/O	FX3S-30M: 2 input channels (voltage)		—		—	2 input channels (voltage) 1 output channel (voltage)		
Built-in Ethernet port	—		—		—	✓		

	FX3U		FX3UC	
	16–128 I/O		16–96 I/O	
Power supply	AC	DC	DC	
CPU module	①	FX3U-16MR/ES, FX3U-32MR/ES, FX3U-48MR/ES, FX3U-64MR/ES, FX3U-80MR/ES, FX3U-128MR/ES	FX3U-16MR/DS, FX3U-32MR/DS, FX3U-48MR/DS, FX3U-64MR/DS, FX3U-80MR/DS	FX3UC-16MR/D-T ^① , FX3UC-16MR/DS-T
	②	FX3U-16MT/ES, FX3U-32MT/ES, FX3U-48MT/ES, FX3U-64MT/ES, FX3U-80MT/ES, FX3U-128MT/ES	FX3U-16MT/DS, FX3U-32MT/DS, FX3U-48MT/DS, FX3U-64MT/DS, FX3U-80MT/DS	FX3UC-16MT/D ^② , FX3UC-32MT/D ^② , FX3UC-64MT/D ^② , FX3UC-96MT/D ^②
	③	FX3U-16MT/ESS, FX3U-32MT/ESS, FX3U-48MT/ESS, FX3U-64MT/ESS, FX3U-80MT/ESS, FX3U-128MT/ESS	FX3U-16MT/DSS, FX3U-32MT/DSS, FX3U-48MT/DSS, FX3U-64MT/DSS, FX3U-80MT/DSS	FX3UC-16MT/DSS, FX3UC-32MT/DSS, FX3UC-64MT/DSS, FX3UC-96MT/DSS
DC input type	Sink/source		Sink/source (except ^① : sink)	
I/O points	Up to 256 local, up to 384 incl. network I/O's		Up to 256 local, up to 384 incl. network I/O's	
Program size	K step		64	
Engineering environment	GX Works2		GX Works2	

Output type:

- ① Relay output ② Transistor output (sink) ③ Transistor output (source)

FX series selection guide

Select system item		Select item specification		Select an applicable FX model						
System item	Item specification*	Terminal-type I/O				Connector-type I/O		Connector/Spring clamp-type I/O		
		Non-extendable*	Extendable			Extendable				
		FX3S	FX3G	FX3GE	FX3U	FX5U	FX3GC	FX3UC	FX5UC	
Hardware	I/O points	Up to 30 local I/O's	●	○	○	○	○	○	○	○
		Up to 128 local I/O's		●	●	○	○	○	○	○
		Up to 256 local I/O's				●	●		●	●
		Up to 384 local I/O's					●		●	●
		Up to 256 local and network I/O's		●	●	○	○	●	○	○
		Up to 384 local and network I/O's				●	○		●	○
		Up to 512 local and network I/O's					●			●
	Power supply	AC power	●	●	●	●	●			
		DC power		●		●	●	●	●	●
	Input type	100 V AC				●	● ^③			● ^③
24 V DC		●	●	●			●	●		
Output type	Relay	●	●	●	●	●		●	● ^④	
	Transistor	●	●	●	●	●	●	●	●	
	Triac					● ^③			● ^③	
CPU speed	Standard	●	●	●	○	○	●	○	○	
	Advanced				●	○		●	○	
	High-speed					●			●	
Communication ports	USB	●	●	●			●			
	RS422	●	●	●	●		●	●		
	RS485	●	●	●					●	
	Ethernet			●		●			●	
Analog I/O	Input: 2, output: 1			●	●	●				
	Up to 4 ADP channels	●	●	●	●	○	●	●	○	
Analog I/O (current/voltage)	Up to 8 ADP channels		● ^①		○	○	●	○	○	
	Up to 16 ADP channels				●	○	●	●	●	
	Up to 64 special function module input channels		●	●	●	○	●	●	○	
	Up to 128 special function module input channels					●			●	
	Up to 4 ADP input channels	●	●	●	●	○	●	●	○	
Temperature sensor input	Up to 8 ADP input channels		● ^①		○	○	●	○	○	
	Up to 16 ADP input channels				●	●	●	●	●	
	Up to 64 special function module input channels		●	●	●	●	●	●	●	
Network	Temperature control		●	●	●	●	●	●	●	
	CC-Link (Master/Slave)		●	●	●	●	●	●	●	
	CC-Link IE Field Slave					●			●	
	CC-Link IE Field Basic Master					●			●	
	ASLink Master					●			●	
	CANopen [®]		●	●	●	●	●	●	●	
	SAE J1939		●	●	●	●	●	●	●	
	Ethernet	●	●	●	●	●	●	●	●	
	Ethernet/IP					●			●	
	Profibus DP Master/Slave		●	●	●	●	●	●	●	
Options	N : N network/parallel link	●	●	●	●	●	●	●	●	
	Computer link (RS232C/RS485)	●	●	●	●	●	●	●	●	
	Non-protocol communication	1 channel (RS232C/RS485)	●	○	●	○	●	○	○	●
		Multi-channel (RS232C)		●		●	●	●	●	●
		Multi-channel (RS485)		●		●	●	●	●	●
	Add-on communication ports	RS422		●	●	●	●		●	
		RS485	●	●	●	●	●	●	●	
		RS232C	●	●	●	●	●	●	●	
		USB				●				●
	Embedded USB	●	●	●			●			
Modbus [®]	●	●	●	●	●	●	●	●		
Inverter control	Analog	●	●	●	●	●	●	●	●	
	Pulse width modulation	●	●	●	●	●	●	●	●	
	RS485 communication	●	●	●	●	●	●	●	●	
Positioning	1 to 2 x 100 kHz axis built-in positioning	●			○	○	●	○	○	
	Up to 3 x 100 kHz axis built-in positioning		● ^②	● ^②	●	●		●	●	
	Up to 4 x 200 kHz axis with high-speed output adapters				●				●	
	Up to 4 x 200 kHz axis built-in positioning					●			●	
	Up to 8 x 1 MHz axis with special function modules				●			●		
	Up to 16 SSCNET III axis with special function modules				●	○		●	○	
	Up to 120 SSCNET III axis with special function modules					○			●	
Up to 128 SSCNET III axis with special function modules					●			●		
Cam switching				●	●		●	●		
High-speed counters	Up to 6 high-speed counters, max. 60 kHz	●	●	●	○	○	●	○	○	
	Up to 8 high-speed counters, max. 100 kHz				●	○		●	○	
	Up to 8 high-speed counters, max. 200 kHz				●	●		●	●	
	Additional extension using high-speed counter block				●	●		●	●	
Storage	Source data storage				●	●		●	●	
	CF card adapter				●			●		
Data logging	SD card					●			●	

● : Contains required functionality ○ : Higher functionality or more expandability ① 14 and 24 I/O points main units : max. 4 channels ② 14 and 24 I/O points main units : max. 2 axes ③ When a terminal module is used. ④ only FX5UC-32MR-TS * Some items require additional extension modules in order to function where other connection rules and requirements may apply. For more details, refer to the respective product manuals.

What components are required for an FX PLC system?

A basic FX PLC system can consist of a stand-alone base unit, with the functionality and I/O range increased by adding extension I/O and special function modules. The following section provides an overview of options available.

Base units

The FX3S, FX3G, FX3U and FX5U can be AC or DC powered, the FX3GC, FX3UC and the FX5UC are only DC powered, both with a mix of input and output styles. The PLCs can be programmed with the user friendly GX Works2 and GX Works3 (FX5 PLCs) programming software, allowing programs to be transferred between different FX PLCs. All PLC base units include an integrated real time clock.

Base units are available with different I/O configurations from 10 to 128 points but can be expanded to 512 points depending upon the FX range selected.

Extension boards

Except for the FX3GC, FX3UC and FX5UC series, extension adapter boards can be installed directly into the base unit and therefore do not require any additional installation space.

Programming is done directly via special commands and dedicated data register in the PLC.

For a small number of digital I/O (2 to 4) an extension adapter board can be installed directly into the FX3S, FX3G, FX3GE, FX3U or FX5U controller. Interface adapter boards can also provide the FX PLC with additional RS232, RS422, RS485 or USB interfaces.

Expansion adapters

The special adapters, also called ADPs, add standard high-speed functions to a FX PLC. Mounted on the left side of a base unit, these units are extremely compact and easy to use.

The programming is similar to the expansion boards via special instructions and dedicated data registers in the PLC.

Available are various serial communication, analog, temperature input, positioning, high-speed counting and data logging ADPs. Compared to the BDs the ADPs offer more flexibility and performance. For the connection of ADP modules, a converter adapter is required for some base units.

Extension I/O modules

Unpowered and powered extension digital I/O modules can be added to the FX3G, FX3GC, FX3GE, FX3U, FX3UC, FX5U and FX5UC PLCs.

A wide range from 8 to 48 I/O points with different inputs and outputs are available. There is no limitation on the number of extension units or blocks, you can design the system to match application requirements, just make sure to check the system power supply and number of available I/O points.

Dedicated I/O blocks for the FX3GC and FX3UC are available as well.

Special function modules

A wide variety of special function modules are available for the FX3G, FX3GC, FX3GE, FX3U, FX3UC, FX5U and FX5UC PLCs. They cover networking functionality, analog control, high-speed input, pulse train outputs, data logging function, temperature inputs and Simple Motion modules.

Thanks to the standardized communication via memory integrated into the special function modules, programming is straightforward.

The integrated CPU performs PLC scan time independent operation perfectly fitted for networking or positioning tasks, thus reducing the load on the PLC base unit. Up to 8 different units can be connected to the base unit.

Memory extension and operator terminals

Each FX family base unit (except FX3GC/FX5U/FX5UC) can be equipped with a memory cassette. The programming unit interface enables the connection of programming tools like PC and hand held programming units as well as graphical operator terminals.

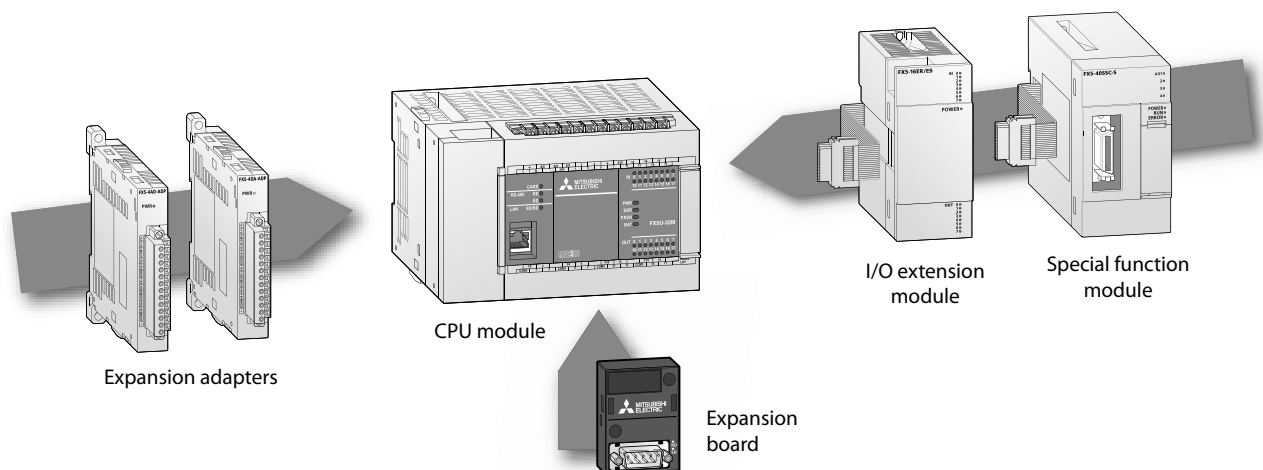

FX series configuration

FX5U

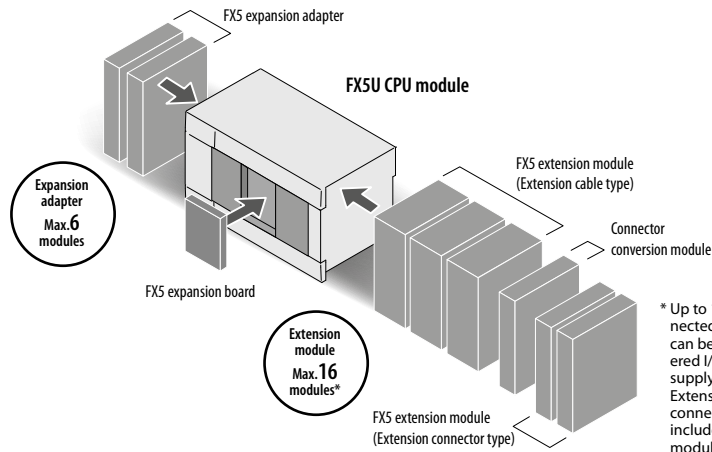

Expansion adapter

FX5-232ADP

Max. 2 modules

Communication

FX5-232ADP For RS232C communication
FX5-485ADP For RS485 communication

FX5-4AD-ADP

Max. 4 modules

Analog

FX5-4AD-ADP For analog input
FX5-4DA-ADP For analog output
FX5-4AD-PT-ADP For resistance temperature detector input
FX5-4AD-TC-ADP^⑥ For thermocouple input

Expansion boards

FX5-422-BD-GOT

Max. 1 module

Communication

FX5-232ADP For RS232C communication
FX5-485ADP For RS485 communication
FX5-422-BD-GOT For RS422 communication (For GOT connection)

Peripheral device

HMI

GOT2000, GOT Simple

CPU module

FX5U-32M

FX5U-32MR/ES	AC	D2	R
FX5U-32MT/ES	AC	D2	T1
FX5U-32MT/ESS	AC	D2	T2
FX5U-32MR/DS	DC	D2	R
FX5U-32MT/DS	DC	D2	T1
FX5U-32MT/DSS	DC	D2	T2

Input: 16 points/Output: 16 points

FX5U-64MR/ES	AC	D2	R
FX5U-64MT/ES	AC	D2	T1
FX5U-64MT/ESS	AC	D2	T2
FX5U-64MR/DS	DC	D2	R
FX5U-64MT/DS	DC	D2	T1
FX5U-64MT/DSS	DC	D2	T2



Input: 32 points/Output: 32 points

FX5U-80MR/ES	AC	D2	R
FX5U-80MT/ES	AC	D2	T1
FX5U-80MT/ESS	AC	D2	T2
FX5U-80MR/DS	DC	D2	R
FX5U-80MT/DS	DC	D2	T1
FX5U-80MT/DSS	DC	D2	T2

Input: 40 points/Output: 40 points

AC	AC power supply	T1	Transistor output (sink)
DC	DC power supply	T2	Transistor output (source)
D2	DC input (sink/source)	R	Relay output

Option

<p>Battery</p> <p>FX3U-32BL</p>	<p>SD memory card</p> <p>SDHC memory card (16 GB)</p>	<p>Engineering tool</p> <p>GX Works3</p>
<p>Extended extension cable</p>  <p>FX5-65EC</p> <p>Extended extension cable FX5-30EC^② FX5-65EC^③</p>	<p>Connector conversion adapter</p>  <p>FX5-CNV-BC</p> <p>Connector conversion adapter FX5-CNV-BC</p>	

Connector connection Cable connection

① When adding the extension module, it is necessary to connect it to the front stage of extension module in case of a shortage of internal power supply in CPU module.

② Attach when connecting an extension cable type module to a distant location or when making two-tier connections. The connector conversion adapter (FX5-CNV-BC) is required when connected with an input/output module (extension cable type), high-speed pulse input/output module, or an intelligent function module. When using also the bus conversion module in the same system, connect the FX5 extension power supply module or the powered I/O module right after the extended extension cable.





③ Can be connected only to the AC power type system.



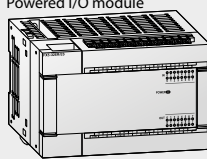
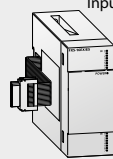
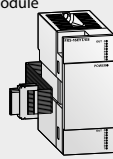

④ Can be connected only to the DC power type system.

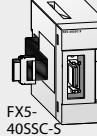
⑤ There are restrictions on the number of extension devices and the connection order of FX5-4AD-TC-ADP. For details, refer to the manual.

⑥ Spring clamp terminal block type.

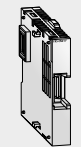
Extension module (cable type)

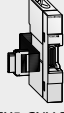
<p>I/O module</p> <div style="display: flex; justify-content: space-around;"> <div style="text-align: center;"> <p>Powered I/O module</p>  <p>FXS-32 ER/ES</p> <p>Powered I/O module</p> <p>FXS-32ER/ES^③ FXS-32ET/ES^③ FXS-32ET/ESS^③ FXS-32ER/DS^③ FXS-32ET/DS^③ FXS-32ET/DSS^③</p> </div> <div style="text-align: center;"> <p>Input/output module</p>  <p>FXS-16 EX/ES</p> <p>Input module</p> <p>FXS-8EX/ES FXS-16EX/ES</p> <p>High-speed pulse input/output module</p> <p>FXS-16ET/ES-H FXS-16ET/ESS-H</p> <p>Input/output module</p> <p>FXS-16ER-ES FXS-16ET-ES FXS-16ET-ESS</p> </div> <div style="text-align: center;"> <p>Output module</p>  <p>FXS-16 EY/ES</p> <p>Output module</p> <p>FXS-8EYR/ES FXS-8EYT/ES FXS-8EYT/ESS FXS-16EYR/ES FXS-16EYT/ES FXS-16EYT/ESS</p> </div> </div>	<p>Intelligent function module</p> <div style="display: flex; flex-direction: column;"> <div style="margin-bottom: 10px;">  <p>FXS-4AD</p> <p>Analog</p> <p>FXS-8AD FXS-4AD FXS-4DA</p> </div> <div style="margin-bottom: 10px;">  <p>FXS-40SSC-S</p> <p>Temperature control</p> <p>FXS-4LC</p> </div> <div style="margin-bottom: 10px;">  <p>FXS-CCLIEF</p> <p>Positioning</p> <p>FXS-20PG-P FXS-20PG-D</p> </div> </div> <p>Extension power supply module</p> <div style="text-align: center;">  <p>FXS-1PSU-5V</p> <p>Extension power supply module</p> <p>FXS-1PSU-5V^③</p> </div> <p>Simple Motion</p> <p>FXS-40SSC-S FXS-80SSC-S</p> <p>Communication/Network</p> <p>FXS-CCLIEF FXS-CCL-MS FXS-ASL-M FXS-DP-M FXS-ENET FXS-ENET/IP</p> <p>CC-Link IE Field CC-Link V2 AnyWireASLINK PROFINET EtherCAT</p>
--	--

<p>Extension module (extension cable type)</p> <p>Connector conversion module</p> <div style="text-align: center;">  <p>FXS-CNV-IF</p> <p>Connector conversion module</p> <p>FXS-CNV-IF</p> </div>	<p>Extension module (extension connector type)</p> <p>I/O module</p> <div style="display: flex; justify-content: space-around;"> <div style="text-align: center;"> <p>Input module</p>  <p>FXS-C16EX/D FXS-C16EX/DS FXS-C32EX/D FXS-C32EX/DS FXS-C32EX/DS-TS^③</p> </div> <div style="text-align: center;"> <p>Output module</p> <p>FXS-C16EYT/D FXS-C16EYT/DSS FXS-C16EYT/D-TS^③ FXS-C32EYT/D FXS-C32EYT/DSS FXS-C32EYT/D-TS^③ FXS-C32EYT/DSS-TS^③</p> </div> </div> <p>Input/output module</p> <p>FXS-C32ET/D FXS-C32ET/DSS FXS-C32ET/DS-TS^③ FXS-C32ET/DSS-TS^③</p> <p>Extension power supply module</p> <div style="text-align: center;"> <p>Extension power supply module</p> <p>FXS-C1PS-SV^{③④}</p> </div>	<p>Bus conversion module</p> <div style="text-align: center;"> <p>Bus conversion module</p> <p>FXS-CNV-BUSC</p> </div> <div style="text-align: center; margin-top: 20px;">  <p>FXS-CNV-BUS</p> <p>Bus conversion module</p> <p>FXS-CNV-BUS</p> </div>	<p>FX3 extension module</p> <p>Intelligent function module</p> <div style="display: flex; flex-direction: column;"> <div style="margin-bottom: 10px;"> <p>Analog</p> <p>FX3U-4AD For input FX3U-4DA For output</p> </div> <div style="margin-bottom: 10px;"> <p>Temperature control</p> <p>FX3U-4LC Temperature control</p> </div> <div style="margin-bottom: 10px;"> <p>Positioning</p> <p>FX3U-1PG For pulse output</p> </div> <div style="margin-bottom: 10px;"> <p>High-speed counter</p> <p>FX3U-2HC For high-speed input</p> </div> <div style="margin-bottom: 10px;"> <p>Communication/Network</p> <p>FX3U-64CCL CC-Link slave FX3U-16CCL-M CC-Link master FX3U-128ASL-M AnyWireASLINK master</p> </div> </div> <p>For the module requiring parameter in FX3 extension module, parameter settings by program are necessary. When connecting the FX3 extension module, the bus speed for FX3 applies for access.</p> <p>Extension power supply module</p> <div style="text-align: center;">  <p>Extension power supply module</p> <p>FXS-1PSU-5V^③</p> </div>
--	---	---	---

FX series configuration

FX5UC

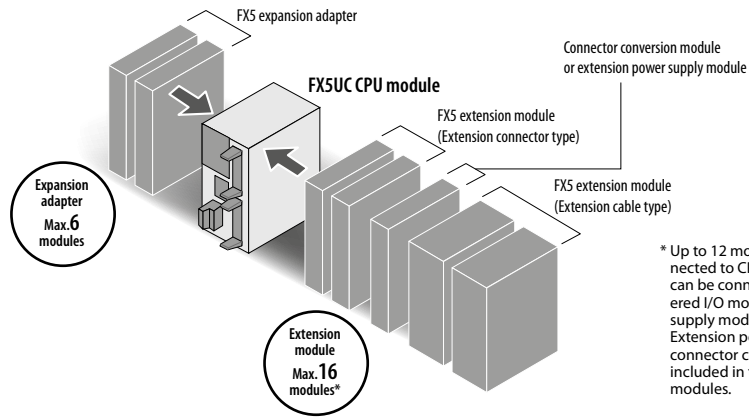

* Up to 12 modules can be directly connected to CPU module. Up to 16 modules can be connected by connecting a powered I/O module or an extension power supply module. Extension power supply modules and connector conversion modules are not included in the number of connected modules.

Expansion adapter



Max. 2 modules

FX5-232ADP

Communication

FX5-232ADP For RS232C communication
FX5-485ADP For RS485 communication



Max. 4 modules

FX5-4AD-ADP

Analog

FX5-4AD-ADP For analog input
FX5-4DA-ADP For analog output
FX5-4AD-PT-ADP For resistance temperature detector input
FX5-4AD-TC-ADP^⑤ For thermocouple input

CPU module

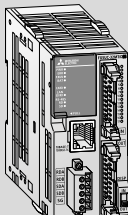

FX5UC-32MT/DSS

FX5UC-32MT/D	DC	D1	T1
FX5UC-32MT/DSS	DC	D2	T2
FX5UC-32MR/DS-TS ^③	DC	D2	R
FX5UC-32MT/DS-TS ^③	DC	D2	T1
FX5UC-32MT/DSS-TS ^③	DC	D2	T2

Input: 16 points/Output: 16 points

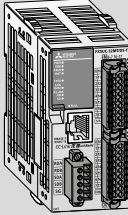

FX5UC-64MT/DSS

FX5UC-64MT/D	DC	D1	T1
FX5UC-64MT/DSS	DC	D2	T2

Input: 32 points/Output: 32 points



FX5UC-96MT/DSS

FX5UC-96MT/D	DC	D1	T1
FX5UC-96MT/DSS	DC	D2	T2

Input: 48 points/Output: 48 points



FX5UC-32MT/DS-TS

DC	DC power supply	T1	Transistor output (sink)
D1	DC input (sink)	T2	Transistor output (source)
D2	DC input (sink/source)	R	Relay output

Extension module (extension connector type)

■ I/O module



FX5-C16EX/D

Input module

FX5-C16EX/D
FX5-C16EX/DSS
FX5-C32EX/D
FX5-C32EX/DSS
FX5-C32EX/DS-TS^③

Output module

FX5-C16EY/D
FX5-C16EY/DSS
FX5-C16EYR/D-TS^③
FX5-C32EY/D
FX5-C32EY/DSS
FX5-C32EY/D-TS^③
FX5-C32EY/DSS-TS^③

I/O module



FX5-C32ET/D
FX5-C32ET/DSS
FX5-C32ET/DS-TS^③
FX5-C32ET/DSS-TS^③

Peripheral device

HMI

GOT2000, GOT Simple

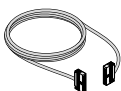
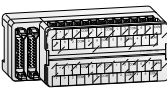
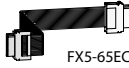
Option

Battery	I/O cable	Terminal block	Power supply cable	Extended extension cable
FX3U-32BL			<p>■ CPU module power supply cable FX2NC-100MPCB (1 m) (attached to CPU module)</p> <p>■ Power supply cable FX2NC-100BPCB (1 m) (attached to FX5UC-□MT/D)</p> <p>■ Power supply crossover cable FX2NC-10BPCB1 (0.1 m) (attached to FX5-C□EX/D, FX5-C32ET/D)</p>	<p></p> <p>FX5-65EC</p> <p>■ Extended extension cable FX5-30EC^④ FX5-65EC^④</p> <p></p> <p>FX5-CNV-BC</p> <p>■ Connector conversion adapter FX5-CNV-BC</p>
<p>■ SD memory card SDHC memory card (16 GB)</p> <p>■ Engineering tool GX Works3</p>	<p>■ For terminal blocks TB-EX-CAB-1M (1 m) TB-EX-CAB-3M (3 m) TB-EX-CAB-5M (5 m) FX-16E-150CAB-R (1.5 m) FX-16E-300CAB-R (3 m) FX-16E-500CAB-R (5 m)</p>	<p>TB-20-S TB-20-C FX-16E-TB/UL FX-32E-TB/UL</p>		

- ① When adding the extension module, it is necessary to connect it to the front stage of extension module in case of a shortage of internal power supply in CPU module.
- ② Next-stage extension connector of an extension power supply module can be used only for either connector connection or cable connection. In case of connector connection, an extension connector type module can be connected.
- ③ Attach when connecting an extension cable type module to a distant location or when making two-tier connections. The connector conversion adapter (FX5-CNV-BC) is required when connected with an input/output module (extension cable type) or an intelligent function module. When using also the bus conversion module in the same system, connect the powered I/O module right after the extended extension cable.
- ④ There are restrictions on the number of extension devices and the connection order of FX5-4AD-TC-ADP. For details, refer to the manual.
- ⑤ Spring clamp terminal block type.

Extension module (extension connector type)

■ Extension power supply module

Extension power supply module
FX5-C1PS-5V ^{①②}

OR

■ Connector conversion module

Connector conversion module
FX5-CNV-IFC

Extension module (extension cable type)

■ I/O module

Powered I/O module
FX5-32-ER/ES

Input/output module
FX5-16EX/ES FX5-16EYT/ES

■ Intelligent function module

Analog
FX5-8AD
FX5-4AD
FX5-4DA

Temperature control
FX5-4LC

Positioning
FX5-20PG-P
FX5-20PG-D

Simple Motion
FX5-40SSC-S
FX5-80SSC-S

Communication/Network
FX5-CCLIEF
FX5-CCL-MS
FX5-ASL-M
FX5-DP-M
FX5-ENET
FX5-ENET/IP

Powered I/O module
FX5-32ER/DS
FX5-32ET/DS
FX5-32ET/DSS

Input module
FX5-8EX/ES
FX5-16EX/ES

Output module
FX5-8EYR/ES
FX5-8EYT/ESS
FX5-16EYR/ES
FX5-16EYT/ESS
FX5-16EYT/ESS

High-speed pulse input/output module
FX5-16ET/ES-H
FX5-16ET/ESS-H

Input/output module
FX5-16ER-ES
FX5-16ET-ES
FX5-16ET-ESS

Bus conversion module

Bus conversion module
FX5-CNV-BUS

FX5-CNV-BUS

Bus conversion module
FX5-CNV-BUSC

FX3 extension module

■ Intelligent function module

Analog
FX3U-4AD For input
FX3U-4DA For output

Temperature control
FX3U-4LC Temperature control

Positioning
FX3U-1PG For pulse output

High-speed counter
FX3U-2HC For high-speed input

Communication/Network
FX3U-64CCL CC-Link slave
FX3U-16CCL-M CC-Link master
FX3U-128ASL-M AnyWireASLINK master

For the module requiring parameter in FX3 extension module, parameter settings by program are necessary. When connecting the FX3 extension module, the bus speed for FX3 applies for access.

FX series configuration

FX3U

Expansion board

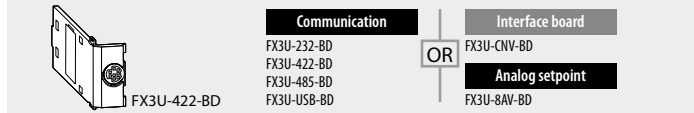

Expansion adapter

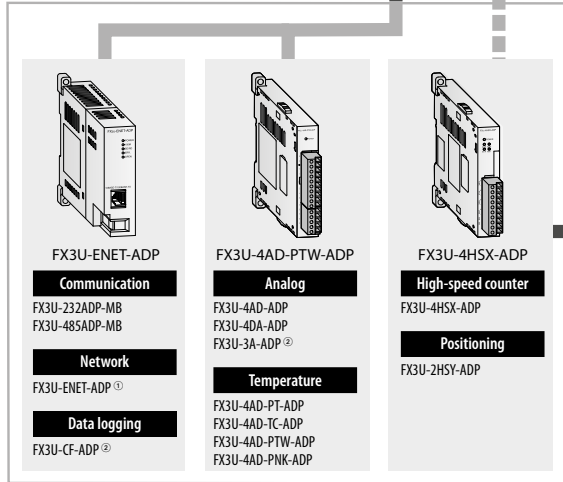

CPU module

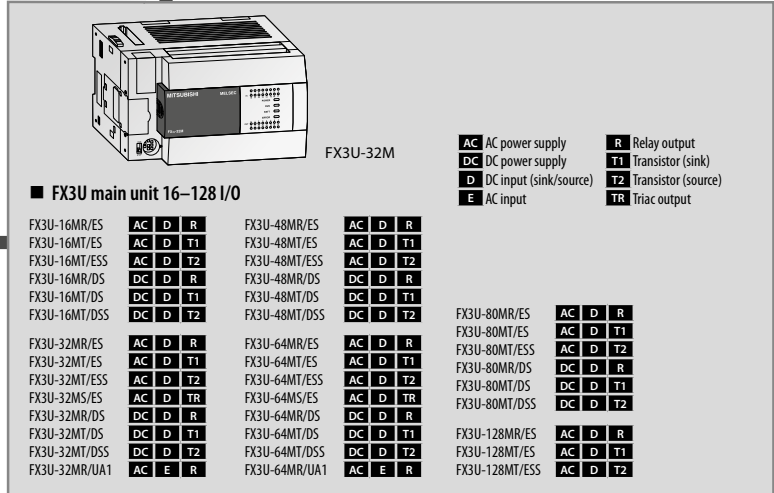

① Firmware version 3.10 or later. ② Firmware version 2.61. ③ Firmware version 3.00 or later.

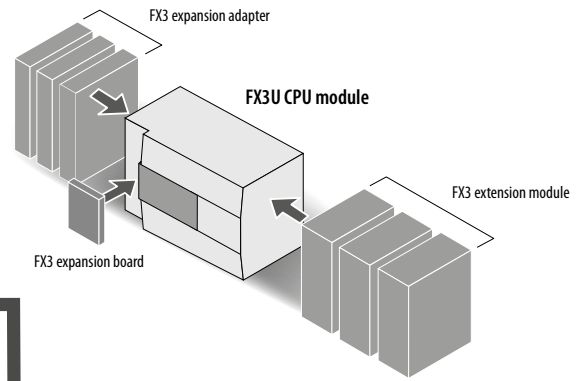

FX3UC

Expansion adapter

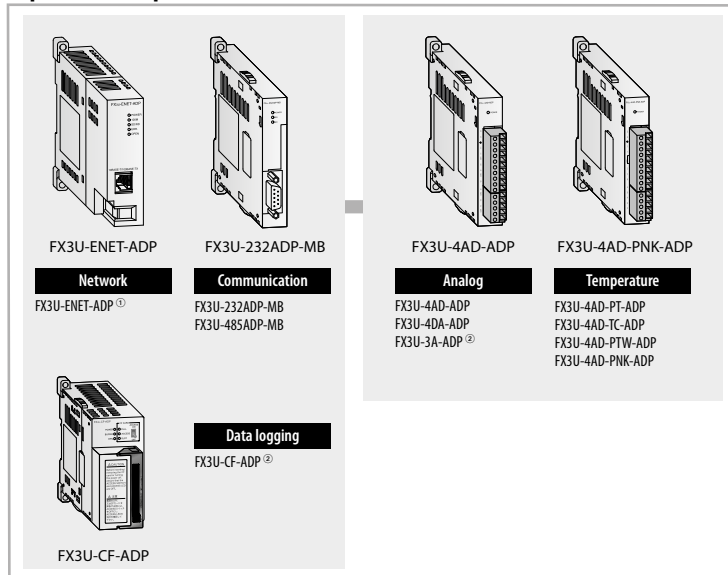

CPU module

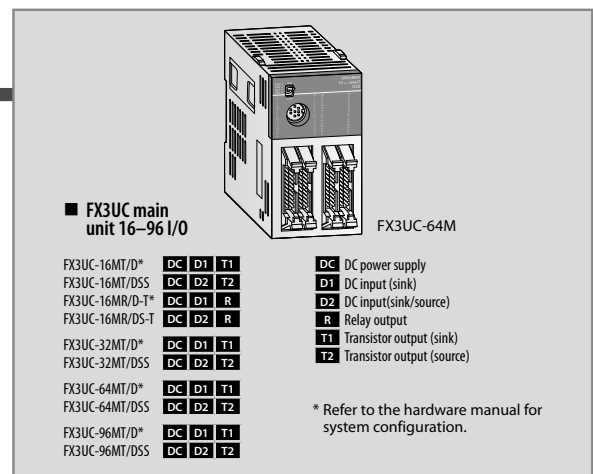

Option



① Firmware version 3.10 or later. ② The FX3UC supports the FX3U-CF-ADP and FX3U-3A-ADP from firmware version 2.61. ③ Firmware version 3.00 or later.

Extension module

■ I/O extension module

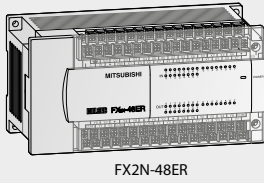

FX2N-48ER

Powered extension unit

Input/output extension unit

- FX2N-32ER-ES/UL
- FX2N-32ET-ESS/UL
- FX2N-48ER-DS
- FX2N-48ER-ES/UL
- FX2N-48ER-UA1/UL
- FX2N-48ET-DSS
- FX2N-48ET-ESS/UL

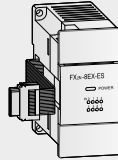

FX2N-8EX

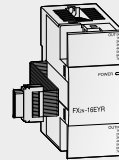

FX2N-16EYR

Unpowered extension block

Input extension block

- FX2N-8EX-ES/UL
- FX2N-8EX-UA1/UL
- FX2N-16EX-ES/UL

Input/output extension block

- FX2N-8ER-ES/UL

Output extension block

- FX2N-8EYR-ES/UL
- FX2N-8EYR-ESS/UL
- FX2N-16EYR-ES/UL
- FX2N-16EYR-ESS/UL
- FX2N-16EYS

■ Power supply unit

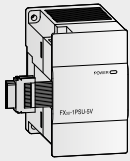

FX3U-1PSU-SV

Power supply unit
FX3U-1PSU-SV

■ Special function block

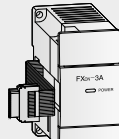

FX0N-3A

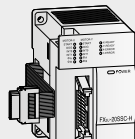

FX3U-20SSC-H

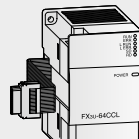

FX3U-64CCL

Analog

- FX0N-3A
- FX2N-2AD
- FX3U-4AD
- FX2N-2DA
- FX3U-4DA
- FX2N-5A
- FX2N-8AD

Positioning

- FX2N-1PG-E
- FX3U-1PG
- FX2N-10PG
- FX3U-20SSC-H
- FX2N-1RM-E-SET
- FX2N-10GM
- FX2N-20GM

Network

- FX2N-32CCL
- FX3U-16CCL-M^①
- FX3U-64CCL
- FX3U-ENET
- FX3U-32DP
- FX3U-64DP-M
- FX3U-CAN
- FX3U-J1939

Temperature

- FX2N-2LC
- FX3U-4LC

High-speed counter

- FX2N-4AD-TC
- FX2N-4AD-PT

Communication

- FX2N-232IF

Option

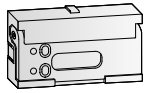

FX3U-FLROM-64L

■ Memory cassette

- FX3U-FLROM-16
- FX3U-FLROM-64
- FX3U-FLROM-64L
- FX3U-FLROM-1M^②

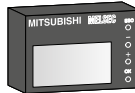

FX3U-7DM

■ Display module

- FX3U-7DM

■ Display module holder

- FX3U-7DM-HLD



FX0N-65EC

■ Battery

- FX3U-32BL

■ Extension cable

- FX0N-30EC (30 cm)
- FX0N-65EC (65 cm)

■ PLC bus connector

- FX2N-CNV-BC

Extension module

■ I/O extension module

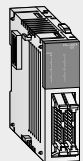

FX2NC-32EX

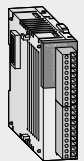

FX2NC-16EYR-T

Input extension block

- FX2NC-16EX-T-DS
- FX2NC-16EX-DS
- FX2NC-32EX-DS

Output extension block

- FX2NC-16EYR-T-DS
- FX2NC-16EYR-T-DSS
- FX2NC-32EYR-T-DSS

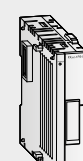

FX3UC-1PS-SV

Power supply unit

- FX3UC-1PS-SV

Interface converter

- FX2NC-CNV-IF

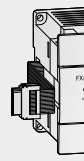

FX2N-8EX

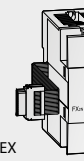

FX2N-16EYR

Input extension block

- FX2N-8EX-ES/UL
- FX2N-8EX-UA1/UL
- FX2N-16EX-ES/UL

Output extension block

- FX2N-8EYR-ES/UL
- FX2N-8EYR-ESS/UL
- FX2N-16EYR-ES/UL
- FX2N-16EYR-ESS/UL
- FX2N-16EYS

■ Special function block

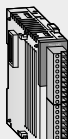

FX3UC-4AD

Analog

- FX3UC-4AD
- FX2NC-4DA

High-speed counter

- FX2NC-1HC

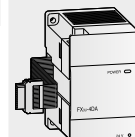

FX3U-4DA

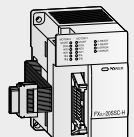

FX3U-20SSC-H



FX3U-64CCL

Analog

- FX0N-3A
- FX2N-2AD
- FX3U-4AD
- FX2N-2DA
- FX3U-4DA
- FX2N-5A
- FX2N-8AD

Positioning

- FX2N-1PG-E
- FX3U-1PG
- FX2N-10PG
- FX2N-10GM
- FX2N-1RM-E-SET
- FX3U-20SSC-H
- FX2N-20GM

Network

- FX2N-32CCL
- FX3U-16CCL-M^①
- FX3U-64CCL
- FX3U-ENET
- FX3U-32DP
- FX3U-64DP-M
- FX3U-CAN
- FX3U-J1939

Temperature

- FX2N-2LC
- FX3U-4LC

High-speed counter

- FX2N-4AD-TC
- FX2N-4AD-PT

Communication

- FX2N-232IF

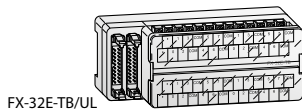

FX32E-TB/UL

■ Terminal block

- TB-20-S
- TB-20-C
- FX-16E-TB/UL
- FX-32E-TB/UL

■ Battery

- FX3U-32BL



FX0N-65EC

■ Extension cable

- FX0N-30EC (30 cm)
- FX0N-65EC (65 cm)

■ PLC bus connector

- FX2N-CNV-BC

■ Power supply cable

- FX2NC-100MPCB (1 m)
- FX2NC-100BPCB (1 m)

FX series configuration

FX3G

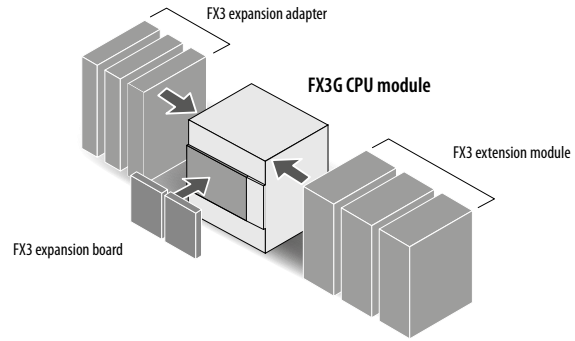

Expansion adapter

<p>Communication</p> <p>FX3U-232ADP-MB FX3U-485ADP-MB</p> <p>Network</p> <p>FX3U-ENET-ADP^①</p>	<p>Analog</p> <p>FX3U-4AD-ADP FX3U-4DA-ADP FX3U-3A-ADP</p> <p>Temperature</p> <p>FX3U-4AD-PT-ADP FX3U-4AD-TC-ADP FX3U-4AD-PTW-ADP FX3U-4AD-PNK-ADP</p>	<p>Interface adapter</p> <p>FX3G-CNV-ADP</p>
---	--	---

① Firmware version 2.00 or later.

Expansion board

<p>Communication</p> <p>FX3G-232-BD FX3G-422-BD FX3G-485-BD</p>	<p>Analog setpoint</p> <p>FX3G-8AV-BD</p>	<p>Analog</p> <p>FX3G-2AD-BD FX3G-1DA-BD</p>	<p>Digital</p> <p>FX3G-4EX-BD FX3G-2EYT-BD</p>
--	--	---	---

CPU module

<p>FX3G-24M</p>	<p>FX3G-40M</p>
-----------------	-----------------

■ FX3G main unit 14–60 I/O

FX3G-14MR/ES	AC	D	R	FX3G-40MR/ES	AC	D	R
FX3G-14MT/ES	AC	D	T1	FX3G-40MT/ES	AC	D	T1
FX3G-14MT/ESS	AC	D	T2	FX3G-40MT/ESS	AC	D	T2
FX3G-14MR/DS	DC	D	R	FX3G-40MR/DS	DC	D	R
FX3G-14MT/DS	DC	D	T1	FX3G-40MT/DS	DC	D	T1
FX3G-14MT/DSS	DC	D	T2	FX3G-40MT/DSS	DC	D	T2
FX3G-24MR/ES	AC	D	R	FX3G-60MR/ES	AC	D	R
FX3G-24MT/ES	AC	D	T1	FX3G-60MT/ES	AC	D	T1
FX3G-24MT/ESS	AC	D	T2	FX3G-60MT/ESS	AC	D	T2
FX3G-24MR/DS	DC	D	R	FX3G-60MR/DS	DC	D	R
FX3G-24MT/DS	DC	D	T1	FX3G-60MT/DS	DC	D	T1
FX3G-24MT/DSS	DC	D	T2	FX3G-60MT/DSS	DC	D	T2

AC AC power supply **R** Relay output
DC DC power supply **T1** Transistor output (sink)
D DC input (sink/source) **T2** Transistor output (source)

FX3GE

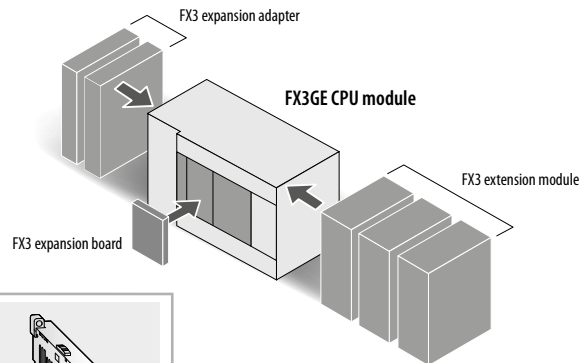

Expansion adapter

<p>Analog</p> <p>FX3U-4AD-ADP FX3U-4DA-ADP FX3U-3A-ADP</p>	<p>Temperature</p> <p>FX3U-4AD-PT-ADP FX3U-4AD-TC-ADP FX3U-4AD-PTW-ADP FX3U-4AD-PNK-ADP</p>	<p>Communication</p> <p>FX3U-232ADP-MB FX3U-485ADP-MB</p>
---	--	--

Expansion board

<p>Communication</p> <p>FX3G-232-BD FX3G-422-BD FX3G-485-BD</p>	<p>Analog setpoint</p> <p>FX3G-8AV-BD</p>	<p>Analog</p> <p>FX3G-2AD-BD FX3G-1DA-BD</p>
--	--	---

CPU module

<p>FX3GE-40M</p>

■ FX3GE main unit 24–40 I/O

FX3GE-24MR/ES	AC	D	R	FX3GE-40MR/ES	AC	D	R
FX3GE-24MT/ES	AC	D	T1	FX3GE-40MT/ES	AC	D	T1
FX3GE-24MT/ESS	AC	D	T2	FX3GE-40MT/ESS	AC	D	T2

AC AC power supply **R** Relay output
D DC input (sink/source)
T1 Transistor output (sink)
T2 Transistor output (source)

① To program FX3GE, select FX3G as the PLC type.

Extension module

■ I/O extension module

Powered extension unit

Input/output extension unit

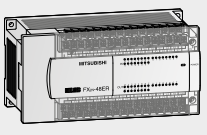

FX2N-48ER

FX2N-32ER-ES/UL
FX2N-32ET-ESS/UL
FX2N-48ER-ES/UL
FX2N-48ER-DS
FX2N-48ET-DSS
FX2N-48ER-UA1/UL
FX2N-48ET-ESS/UL

Unpowered extension block

Input extension block

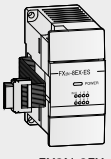

FX2N-8EX

FX2N-8EX-ES/UL
FX2N-8EX-UA1/UL
FX2N-16EX-ES/UL

Output extension block

FX2N-8EYR-ES/UL
FX2N-8EYT-ESS/UL
FX2N-16EYR-ES/UL
FX2N-16EYT-ESS/UL
FX2N-16EYS

Input/output extension block

FX2N-8ER-ES/UL

■ Power supply unit

Power supply unit

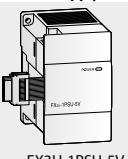

FX3U-1PSU-5V

■ Special function block

Analog	Temperature	Network
FX2N-2AD FX3U-4AD FX2N-2DA FX3U-4DA FX2N-5A FX2N-8AD	FX2N-2LC FX3U-4LC FX2N-4AD-TC FX2N-4AD-PT	FX2N-32CCL FX3U-16CCL-M ① FX3U-64CCL FX3U-ENET FX3U-32DP FX3U-CAN FX3U-J1939

Option

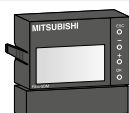
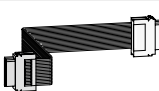
<p>■ Memory cassette</p>  <p>FX3G-EEPROM-32L</p> <p>FX3G-EEPROM-32L</p>	<p>■ Display module</p>  <p>FX3G-5DM</p> <p>FX3G-5DM</p>	<p>■ Extension cable</p>  <p>FX0N-65EC</p> <p>FX0N-30EC (30 cm) FX0N-65EC (65 cm)</p>	<p>■ PLC bus connector</p> <p>FX2N-CNV-BC</p>	<p>■ Battery</p> <p>FX3U-32BL</p>
--	---	--	---	-----------------------------------

Extension module

■ I/O extension module

Powered extension unit

Input/output extension unit

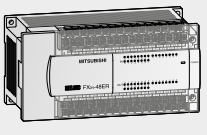

FX2N-48ER

FX2N-32ER-ES/UL
FX2N-32ET-ESS/UL
FX2N-48ER-ES/UL
FX2N-48ER-DS
FX2N-48ET-DSS
FX2N-48ER-UA1/UL
FX2N-48ET-ESS/UL

Unpowered extension block

Input extension block

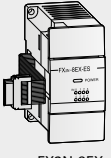

FX2N-8EX

FX2N-8EX-ES/UL
FX2N-8EX-UA1/UL
FX2N-16EX-ES/UL

Output extension block

FX2N-8EYR-ES/UL
FX2N-8EYT-ESS/UL
FX2N-16EYR-ES/UL
FX2N-16EYT-ESS/UL
FX2N-16EYS

Input/output extension block

FX2N-8ER-ES/UL

■ Power supply unit

Power supply unit

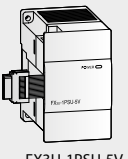

FX3U-1PSU-5V

■ Special function block

Analog	Temperature	Network
FX2N-2AD FX3U-4AD FX2N-2DA FX3U-4DA FX2N-5A FX2N-8AD	FX2N-2LC FX3U-4LC FX2N-4AD-TC FX2N-4AD-PT	FX2N-32CCL FX3U-16CCL-M ① FX3U-64CCL FX3U-ENET FX3U-32DP FX3U-CAN FX3U-J1939

Option

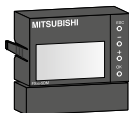
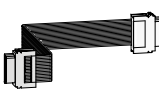
<p>■ Memory cassette</p>  <p>FX3G-EEPROM-32L</p> <p>FX3G-EEPROM-32L</p>	<p>■ Display module</p>  <p>FX3G-5DM</p> <p>FX3G-5DM</p>	<p>■ Extension cable</p>  <p>FX0N-65EC</p> <p>FX0N-30EC (30 cm) FX0N-65EC (65 cm)</p>	<p>■ PLC bus connector</p> <p>FX2N-CNV-BC</p>	<p>■ Battery</p> <p>FX3U-32BL</p>
--	---	--	---	-----------------------------------

FX series configuration

FX3GC

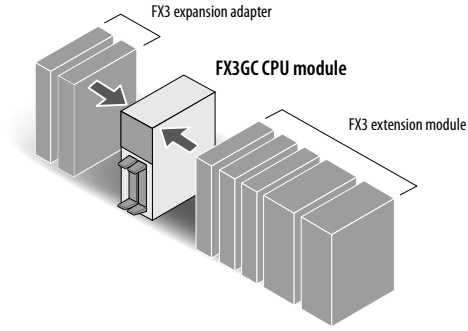

Expansion adapter

<p>Network FX3U-ENET-ADP^①</p>	<p>Communication FX3U-232ADP-MB FX3U-485ADP-MB</p>	<p>Analog FX3U-4AD-ADP FX3U-4DA-ADP FX3U-3A-ADP</p>	<p>Temperature FX3U-4AD-PT-ADP FX3U-4AD-TC-ADP FX3U-4AD-PTW-ADP FX3U-4AD-PNK-ADP</p>
---	---	--	---

CPU module

FX3GC main unit 32 I/O

FX3GC-32MT/D **DC** **D** **T1**
 FX3GC-32MT/DSS **DC** **D** **T2**

DC DC power supply **T1** Transistor output (sink)
D DC input (sink/source) **T2** Transistor output (source)

① Firmware version 2.00 or later.

Option

Connecting to terminal block

TB-EX-CAB-1M (1 m)	FX-16E-150CAB-R (1.5 m)
TB-EX-CAB-3M (3 m)	FX-16E-300CAB-R (3 m)
TB-EX-CAB-5M (5 m)	FX-16E-500CAB-R (5 m)

FX3S

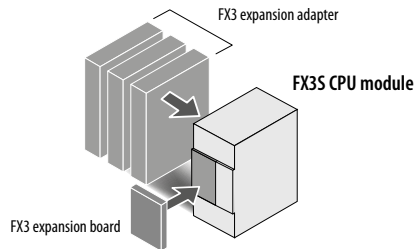

Expansion adapter

<p>Network FX3U-ENET-ADP</p>	<p>Communication FX3U-232ADP-MB FX3U-485ADP-MB</p>	<p>Analog FX3U-4AD-ADP FX3U-4DA-ADP FX3U-3A-ADP</p>	<p>Temperature FX3U-4AD-PT-ADP FX3U-4AD-TC-ADP FX3U-4AD-PTW-ADP FX3U-4AD-PNK-ADP</p>	<p>Interface adapter FX3S-CNV-ADP</p>
---	---	--	---	--

Expansion board

<p>Communication</p> <p>FX3G-232-BD FX3G-422-BD FX3G-485-BD</p>	<p>Analog setpoint</p> <p>FX3G-8AV-BD</p>	<p>Analog</p> <p>FX3G-2AD-BD FX3G-1DA-BD</p>	<p>Digital</p> <p>FX3G-4EX-BD FX3G-2EYT-BD</p>
--	--	---	---

FX3G-232-BD

Extension module

■ I/O extension block

Input extension block

FX2NC-16EX-T-DS
FX2NC-16EX-DS
FX2NC-32EX-DS

Output extension block

FX2NC-16EYR-T-DS
FX2NC-16EYT-DS5
FX2NC-32EYT-DS5

Power supply unit

FX3UC-1PS-5V

OR

Interface converter

FX2NC-CNV-IF

Unpowered extension block

Input extension block

FX2N-8EX-ES/UL
FX2N-8EX-UA1/UL
FX2N-16EX-ES/UL

Output extension block

FX2N-8EYR-ES/UL
FX2N-8EYT-ESS/UL
FX2N-16EYR-ES/UL
FX2N-16EYT-ESS/UL
FX2N-16EYS

Input/output extension block

FX2N-8ER-ES/UL

■ Special function block

Analog

FX3UC-4AD
FX2NC-4DA

FX3UC-4AD

Analog

FX2N-2AD
FX3U-4AD
FX2N-2DA
FX3U-4DA
FX2N-SA
FX2N-8AD

FX3U-4DA

Temperature

FX2N-2LC
FX3U-4LC
FX2N-4AD-TC
FX2N-4AD-PT

Network

FX2N-32CCL
FX3U-16CCL-M^①
FX3U-64CCL
FX3U-ENET
FX3U-32DP
FX3U-CAN
FX3U-J1939

■ Terminal block

TB-20-S
TB-20-C
FX-16E-TB/UL
FX-32E-TB/UL

■ Battery

FX3U-32BL

■ Extension cable

FX0N-30EC (30 cm)
FX0N-65EC (65 cm)

■ PLC bus connector

FX2N-CNV-BC

■ Power supply cable

FX2NC-100MPCB (1 m)
FX2NC-100BPCB (1 m)

CPU module

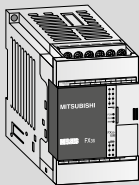

FX3S-10M

■ FX3S main unit 10-30 I/O

FX3S-10MR/ES FX3S-10MT/ES FX3S-10MT/ESS	FX3S-20MR/ES FX3S-20MT/ES FX3S-20MT/ESS	AC AC power supply D DC input (sink/source) R Relay output T1 Transistor output (sink) T2 Transistor output (source)
FX3S-14MR/ES FX3S-14MT/ES FX3S-14MT/ESS	FX3S-30MR/ES FX3S-30MT/ES FX3S-30MT/ESS	

Option

■ Memory cassette

FX3G-EEPROM-32L



FX3G-EEPROM-32L

Calculation of the power consumption

The power consumption figures on the 5 V DC bus for the special function modules are shown in the specifications tables on the following pages.

The maximum permissible currents on the 5 V DC and 24 V DC bus are shown in the table below.

Modules	Max. current	
	5 V bus	24 V bus
FX3G-14/24M□-ES(ESS)	—	400 mA
FX3G-40/60M□-ES(ESS)	—	400 mA
FX3U-16/32M□-ES(ESS)	500 mA	400 mA
FX3U-48-128M□-ES(ESS)	500 mA	600 mA
FX3UC-16MT/D(DSS)	600 mA	—
FX3UC-32MT/D(DSS)	560 mA	—
FX3UC-64MT/D(DSS)	480 mA	—
FX3UC-96MT/D(DSS)	400 mA	—
FX5U-32M□/E□	900 mA	480 mA
FX5U-64M□/E□	1100 mA	740 mA
FX5U-80M□/E□	1100 mA	770 mA
FX5UC-32/64/96MT/□	720 mA	500 mA

The residual currents for the 24 V DC service voltage at different input/output configurations are shown in the tables on the right.

A maximum of 256 I/Os are possible for FX3U/FX3UC/FX5U/FX5UC (128 I/Os for FX3G/FX3GC).

Max. residual current values (in mA) for FX3U-16M□/E□□ through FX3U-32M□/E□□ for the permissible configuration

Number of additional outputs	40	25													
	32	100	50	0											
	24	175	125	75	25										
	16	250	200	150	100	50	0								
	8	325	275	225	175	125	75	25							
	0	400	350	300	250	200	150	100	50	0					
		0	8	16	24	32	40	48	56	64					
		Number of additional inputs													

Max. residual current values (in mA) for FX3U-48M□/E□□ through FX3U-128M□/E□□ for the permissible configuration

Number of additional outputs	64	0																	
	56	75	25																
	48	150	100	50	0														
	40	225	175	125	75	25													
	32	300	250	200	150	100	50	0											
	24	375	325	275	225	175	125	75	25										
	16	450	400	350	300	250	200	150	100	50	0								
	8	525	475	425	375	325	275	225	175	125	75	25							
0	600	550	500	450	400	350	300	250	200	150	100	50	0						
		0	8	16	24	32	40	48	56	64	72	80	88	96					
		Number of additional inputs																	

Sample calculations

The tables below and on the right show different examples for sample power calculation for a PLC system.

The current values for the special function modules can be found in the specifications on the following pages.

Comparison with the current value tables show that the calculated figures for the 5 V bus lie within the allowable ranges.

In the example below all units can be supplied sufficiently with the internal 24 V power supply.

Module	No.	24 V DC calculation		5 V DC calculation	
		Current/module	Calculation	Current/module	Total current
FX3U-80MR/ES	1	600 mA	+600 mA	+500 mA	+500 mA
FX3U-4AD	2	90 mA	-180 mA	110 mA	-220 mA
FX3U-4DA	2	160 mA	-320 mA	120 mA	-240 mA
FX3U-ENET	1	240 mA	-240 mA	—	—
			-140 mA !!!		500-460 mA
				Result:	40 mA (OK !)

An external 24 V power supply has to be added in the example above. 

Module	No.	Number of I/Os			24 V DC calculation		5 V DC calculation		
		X	Y	X/Y	Total ①	Total current ②	Current/module	Total current	
FX3U-48MR/ES	1	24	24	—	X = 8 Y = 24 →	+325 mA	500 mA	+500 mA	
FX2N-16EYR-ES/UL	1	—	16	—			—	0 mA	
FX2N-8EX-ES/UL	1	8	—	—			—	0 mA	
FX2N-8EYR-ES/UL	1	—	8	—			—	0 mA	
FX3U-4AD-PT-ADP	1	—	—	—		-50 mA	30 mA	-15 mA	
						+275 mA (OK!)		+485 mA (OK!)	
FX2N-32ER-ES/UL	1	16	16	—	X = 16 Y = 0 →	+150 mA residual current for extension unit FX2N-32ER-ES/UL	690 mA	+690 mA	
FX2N-16EX-ES/UL	1	16	—	—			—	0 mA	
FX2N-10PG	1	—	—	8			0 mA	120 mA	-120 mA
FX2N-32CCL	1	—	—	8			-50 mA	130 mA	-130 mA
Result:					64 + 64 + 16 = 144! (< 256) OK!	+100 mA (OK!)		+440 mA (OK!)	

① Total no. of I/Os which are connected to a base unit to calculate the max. residual current values (see tables)

② See tables above (max. residual current values)

MELSEC iQ-F built-in functions

High-speed system bus communication

FX3 series FX5 iQ-F series

High-speed system bus communication at 1.5 K words/ms (approximately 150 times faster compared with FX3U) together with a high-speed CPU allows MELSEC iQ-F to output maximum performance even when heavy data communication intelligent function modules are used.

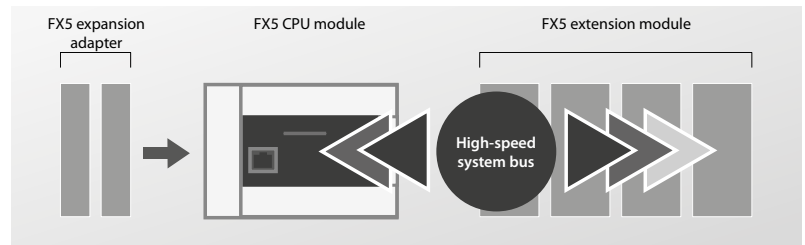

Built-in Ethernet port

FX3 series FX5 iQ-F series

The built-in Ethernet communication port can handle communication of up to 8 connections on the network and supports multiple connections with personal computers and other devices.



PLC to PLC communication

Directly connect to other PLCs.



SLMP communication

PCs and other devices can communicate with the CPU module via the open protocol SLMP (SeamLess Message Protocol).

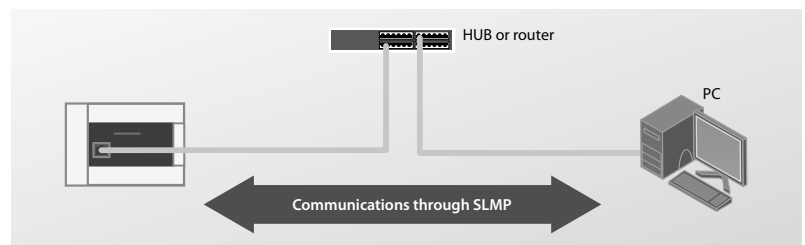

Remote maintenance

Secure remote connectivity to the PLC is possible via a VPN tunnel.

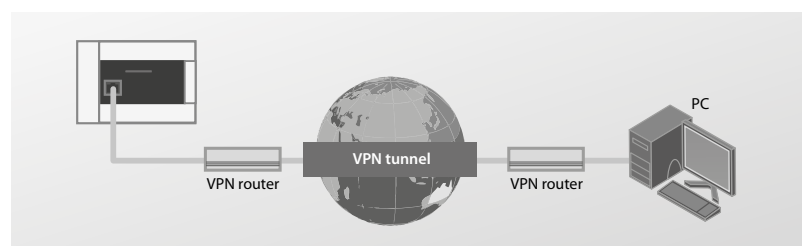

Built-in analog inputs/outputs (with alarm output)

FX3 series FX5 iQ-F series

The FX5U is equipped with two 12-bit analog inputs and one analog output. Setup is done with parameter settings, no programming required. Value shifting, scaling and alarm output can also be set easily with parameters.

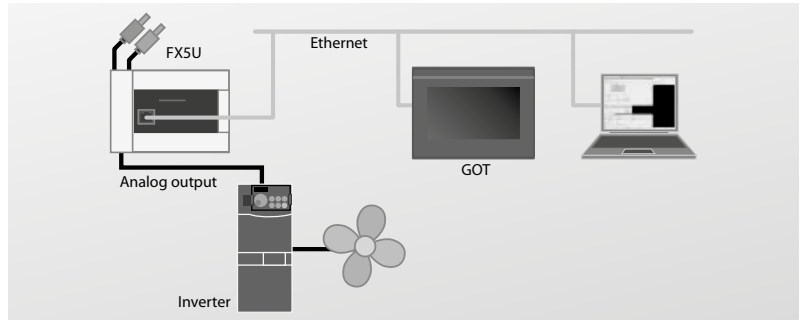

Inverter control using analog output

Built-in RS485 port (with Modbus® function)

FX3 series FX5 iQ-F series

With the built-in RS485 port FX5U/FX5UC can connect to serial devices up to 50 m away. Dedicated inverter communication instructions allow to control up to 16 Mitsubishi inverters. Additionally Modbus® is supported and enables the FX5U/FX5UC to connect to up to 32 devices such as PLCs, sensors and temperature controllers.

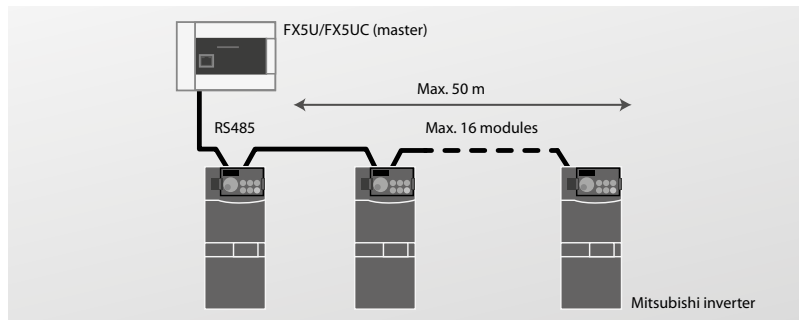

Inverter communication

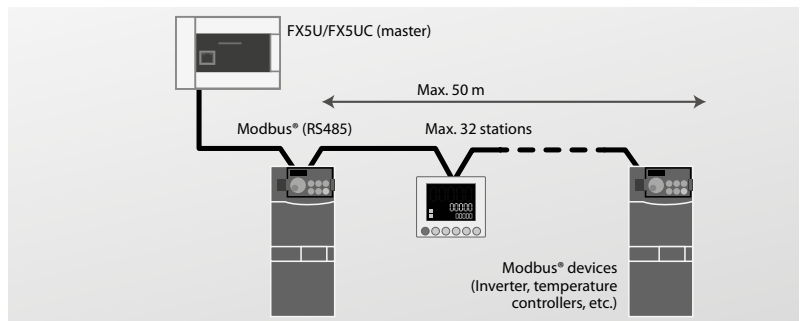

Modbus® communication

Built-in SD card slot

FX3 series FX5 iQ-F series

The built-in SD card slot of FX5 can be used to simplify the startup of mass production equipment and also store logging data.

Via an SD card it's possible to update the firmware of an FX5 CPU to take advantage of newly added functions ^① and additionally the SD card acts as the storage location ^② for the user web server data.

- ① Please check if the FX5 hardware is compatible to the new firmware functions.
- ② Supported by FX5U/FX5UC Ver. 1.100 or later, serial number 17X□□□□ and GX Works3 Ver. 1.047Z or later

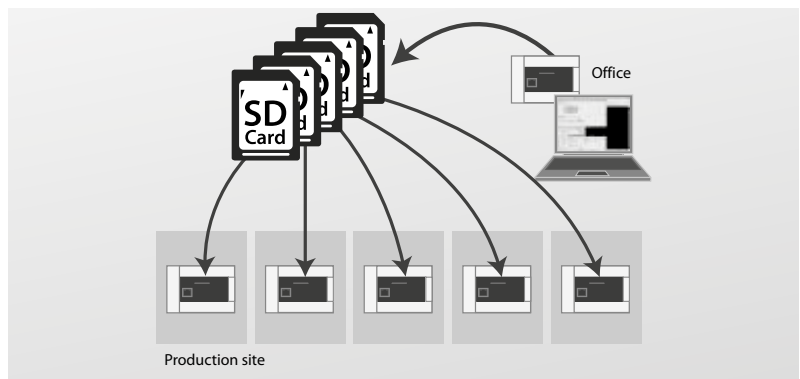

Mass-production of equipment using SD memory card

Webserver ①

FX3 series FX5 iQ-F series

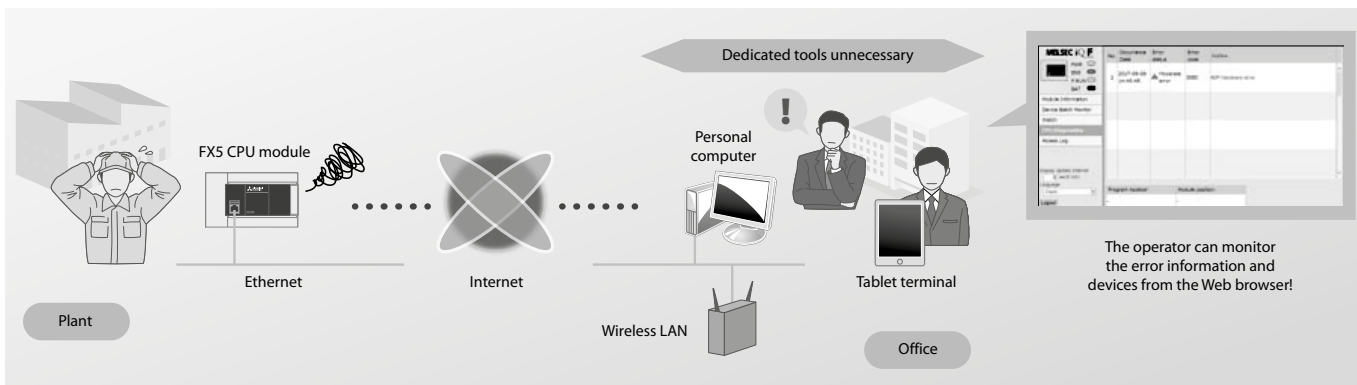

Monitoring of PLCs without dedicated tools

There are no dedicated tools needed to perform remote maintenance on an iQ-F series PLC. Simply use a web browser to check the operation status, monitor devices and change their values.

Additionally this function allows users to access the CPU diagnostics and detailed information to perform efficient trouble shooting.

Users can choose between a predefined webpage or design their own one using HTML5, JavaScript and CSS3 ②.

① Supported by FX5U/FX5UC Ver. 1.060.

② Supported by FX5U/FX5UC Ver. 1.100.

Real-time monitoring ①

FX3 series FX5 iQ-F series

Efficient debugging at troubleshooting

Using the real-time monitoring function operators can monitor device values in real-time via the GX LogViewer software. Device values are displayed in this software in trend graphs, that's why users can recognize any changes quickly which helps to improve troubleshooting efficiency.

① Supported by FX5U/FX5UC Ver. 1.060.

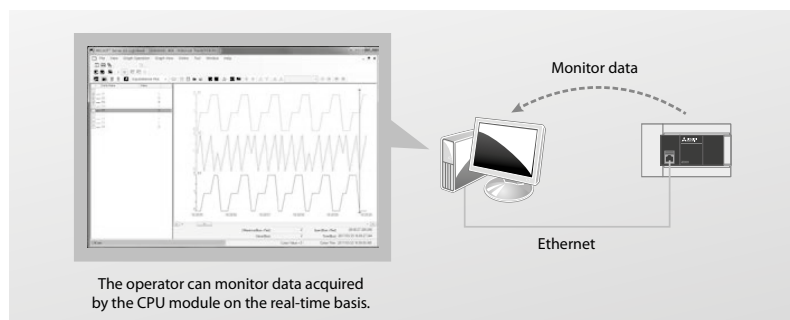

Modbus®/TCP ①

FX3 series FX5 iQ-F series

Further expansion of applicable systems

iQ-F series PLCs can be used as master or slave stations in a Modbus®/TCP network communicating with other vendors automation products.

① Supported by FX5U/FX5UC Ver. 1.060.

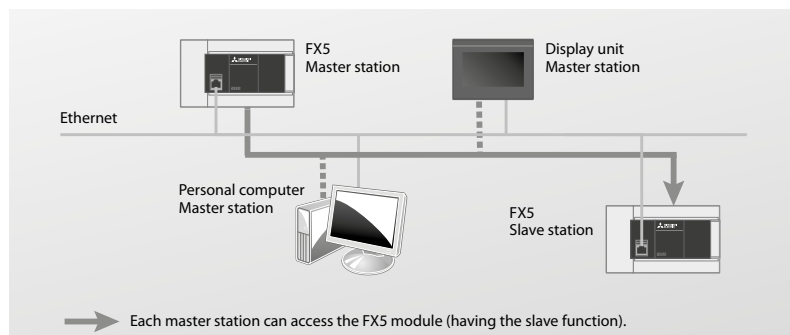

■ **SNTP client (Time setting function)** ①

FX3 series FX5 iQ-F series

Every operation at correct time

By supporting the SNTP client time setting function FX5U/ FX5UC CPUs can acquire time information from a time information server (SNTP Server) via the network and set the CPU clock accordingly. This function ensures correct starting times of operations.

① Supported by FX5U/FX5UC Ver. 1.060.

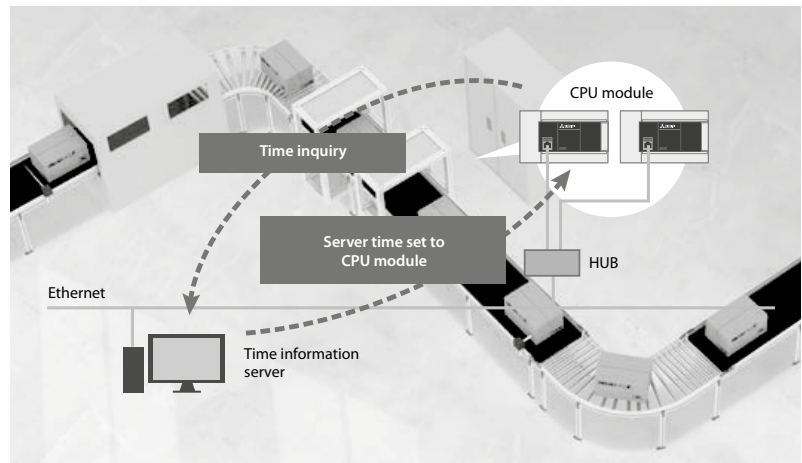

■ **Event history function** ①

FX3 series FX5 iQ-F series

Information such as errors detected in the PLC CPU, expansion board and expansion adapter are collected and saved by the CPU module. Once the errors are stored, they can be checked chronologically. This function allows to pinpoint the cause of faults that occur in the system or device.

① Supported by FX5U/FX5UC Ver. 1.040.

No.	Occurrence Date	Event Type	Status	Event Code	Overview	Source	Mounting Point No.
00001	2016/11/15 13:24:20.177	System	OK	00000	Link-down	FX5U-200A-05 CPU Module	
00002	2016/11/15 13:25:52.015	System	Warning	02040	Operation error	FX5U-200A-05 CPU Module	
00003	2016/11/15 13:26:04.058	System	Warning	02040	Operation error	FX5U-200A-05 CPU Module	
00004	2016/11/15 13:26:08.058	System	Warning	02040	Operation error	FX5U-200A-05 CPU Module	
00005	2016/11/15 13:26:02.058	System	Warning	02040	Operation error	FX5U-200A-05 CPU Module	
00006	2016/11/15 13:26:58.055	System	Warning	02040	Operation error	FX5U-200A-05 CPU Module	
00007	2016/11/15 13:27:01.040	System	Warning	02040	Operation error	FX5U-200A-05 CPU Module	
00008	2016/11/15 13:28:05.000	System	Warning	02040	Operation error	FX5U-200A-05 CPU Module	

■ **Memory dump function** ① ②

FX3 series FX5 iQ-F series

By setting memory dump...

The collected device data is stored into SD memory card.

Use the information when debugging systems under development, or for troubleshooting when trouble occurs at a remote location, etc.

The collection results can be confirmed with GX Works3. The device list can be displayed in the memory dump results display, and the memory dump conditions can be repeated on the offline monitor.

By meeting a defined trigger action like a specific bit device turning on or an error occurring the memory dump function will store selected device values of the CPU module on the SD card.

Checking this data at a desired time supports the analysis of problems which occur depending on particular conditions.

- ① The memory dump function and data logging function are not simultaneously available. There are some restrictions on the use of the backup/restore functions. For details, refer to the manual.
- ② Supported by FX5U/FX5UC Ver. 1.050 or later and product number 16V□□□□ or later, and by GX Works3 Ver. 1.035M or later.

Parallel link function ①

FX3 series FX5 iQ-F series

This function is designed to connect two FX5 PLCs and automatically link mutual device data. On/Off status and data register values of the other station can quickly be checked.

① Supported by FX5U/FX5UC Ver. 1.060.

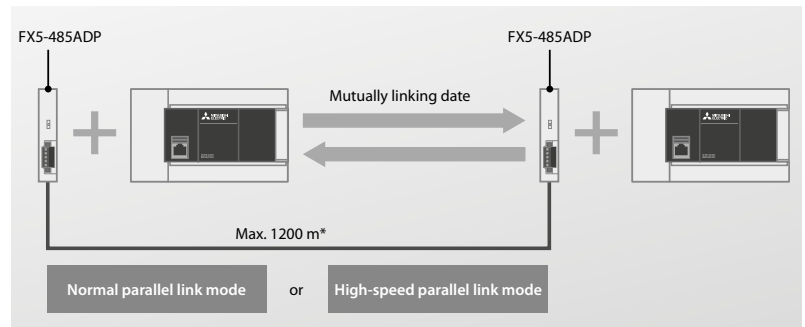

* 50 m or less when the built-in RS485 port and FX5-485-BD are included.

IP filter function ①

FX3 series FX5 iQ-F series

The IP filter function identifies the IP address of the access source and prevents access from a non authorized IP address.

① Supported by FX5U/FX5UC Ver. 1.050 or later, and GX Works3 Ver. 1.035M or later.

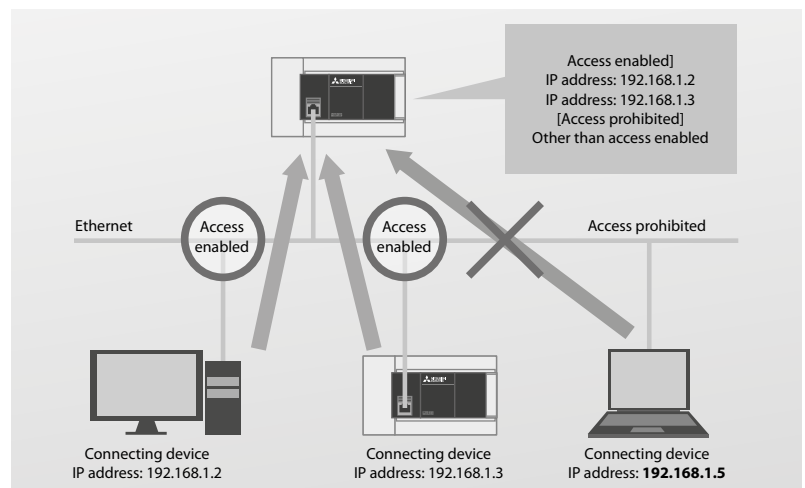

Data backup/restoration function ① (device/label data ②③, data memory ④)

FX3 series FX5 iQ-F series

Device/label data and data memory in the CPU can be backed up to the SD card and backed-up data can be restored as needed. If the SD card is mounted on the CPU the data can be backed up and be restored at any time.

When the CPU module auto exchange function is used, backed-up data from the SD card is automatically restored when the power is turned on or the CPU is reset. If the CPU fails, it can recover quickly without the need of a PC or software.

- ① While the backup/restore function is executed, some functions are temporarily unavailable. For details, refer to the manual.
- ② Supported by FX5U/FX5UC Ver. 1.045 or later.
- ③ Excluding the buffer memory of the intelligent function module.
- ④ Supported by FX5U/FX5UC Ver. 1.050 or later.

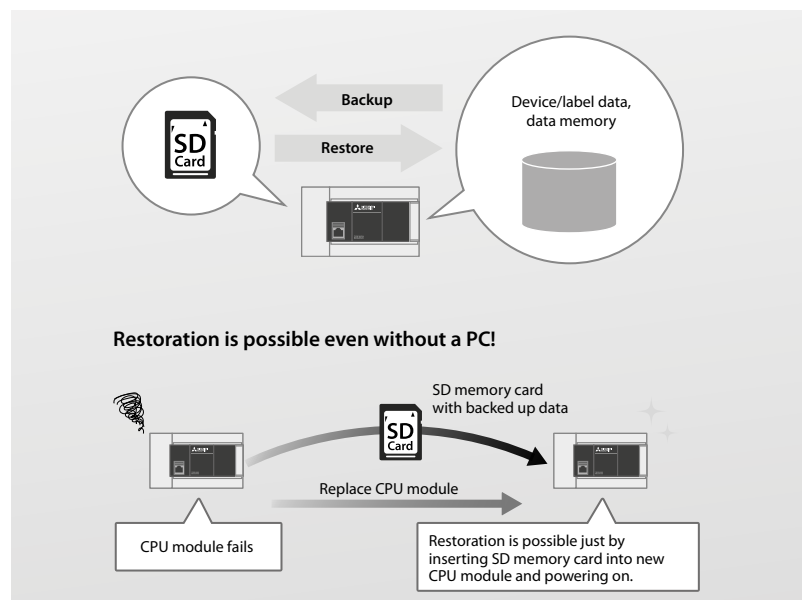

Data logging ① ②

FX3 series FX5 iQ-F series

To meet the future needs of Industry 4.0, the FX5 offers comprehensive data logging functionality as standard, with all data from energy consumption to product throughput captured, at a specified interval or random timing, on a standard SD card for further analysis.

Continuous logging at a maximum speed of 10-ms cycles is possible. In addition, an internal buffer capacity can be set to store the collected results temporarily.

By using the FTP server function, logged data can be transferred to an office computer acting as a FTP client.

- ① Supported by FX5U/FX5UC Ver. 1.040 or later and product number 16Y□□□□□ or later, by GX Works3 Ver. 1.030G or later, and by CPU Module Logging Configuration Tool Ver. 1.64S or later.
- ② The data logging function and memory dump function cannot be used simultaneously. There are some restrictions on the use of the backup/restore functions. For details, refer to the manual.

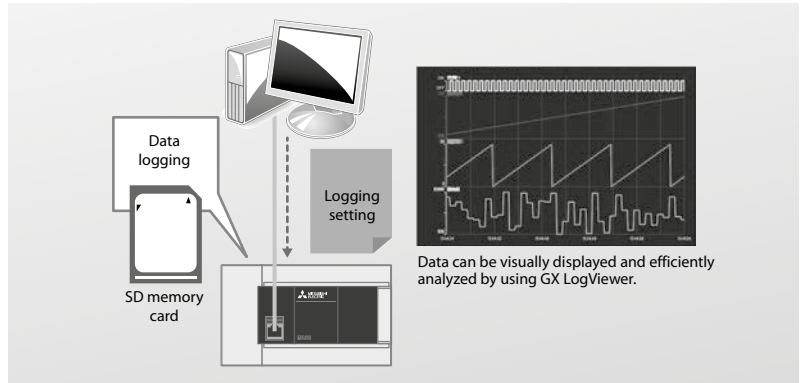

FTP server function ③

FX3 series FX5 iQ-F series

Logging data can easily be acquired from remote locations via the FTP server function of the built-in Ethernet port on FX5 CPUs. This reduces management and maintenance efforts as multiple logging files can be handled collectively from an office computer.

- ① Supported by FX5U/FX5UC Ver. 1.040 or later and product number 16Y□□□□□ or later, and by GX Works3 Ver. 1.030G or later.

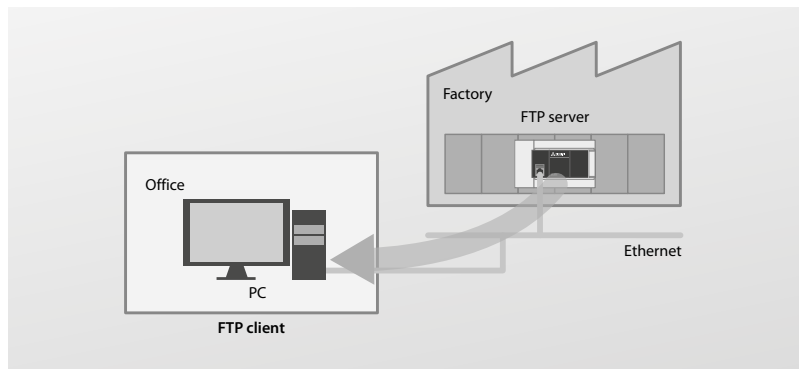

Logs can be examined and utilized from remote locations!

Security functions

FX3 series FX5 iQ-F series

To protect your intellectual property the FX5 comes with several built-in security functions such as:

- Remote password/security key
- Privilege based program access
- Program on SD card with copy protection password

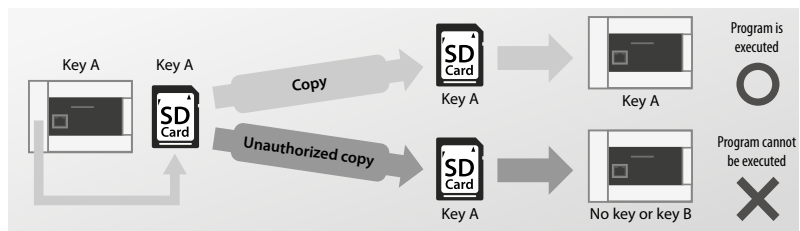

Security key function

Intuitive programming environment

FX3 series FX5 iQ-F series

GX Works3

- Easy programming by drag and drop
- Reduced development time with module function blocks
- Parameter set-up for a variety of functions

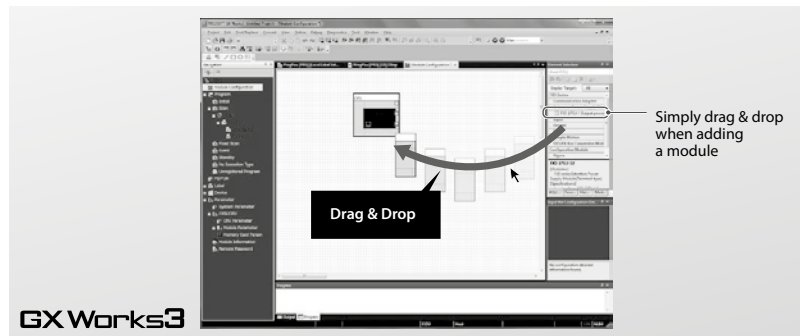

Graphical system design

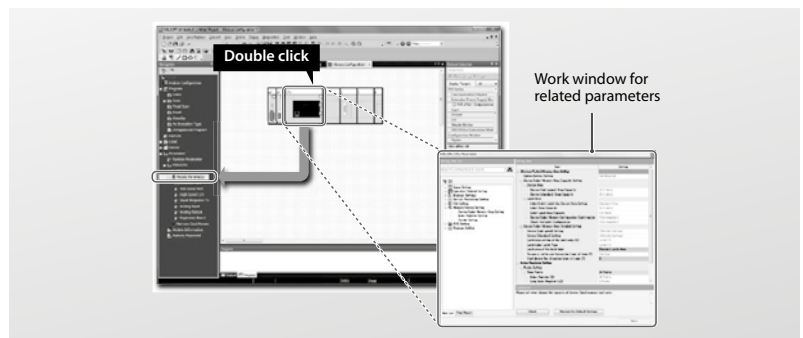

Auto-generation of module parameters

Battery-less and maintenance-free

FX3 series FX5 iQ-F series

MELSEC iQ-F series holds programs and devices in non-volatile memory such as flash ROM and does not require a battery.

Note: It is possible to increase the capacity of held devices by using an optional battery.

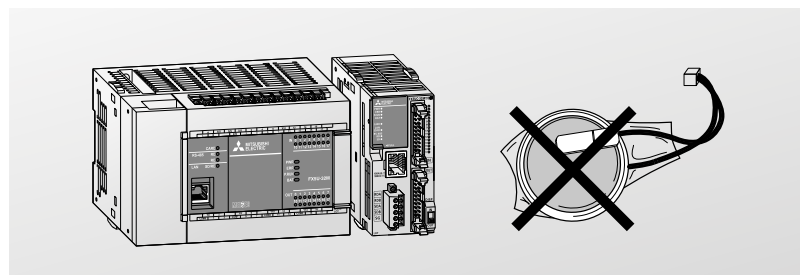

■ Built-in positioning (4 axes built-in (200 kpps) + 2 axes (200 kpps))

FX3 series FX5 iQ-F series

Positioning that support 20 μs high-speed startup

FX5 features powerful positioning functionality with 8-channel high-speed pulse inputs and 4-axis pulse outputs.

In addition to the existing interrupt stop operation and variable speed operation, new functions have been added and made even easier to use. Furthermore, up to four high-speed pulse I/O modules can be connected for affordable multi-axis control.

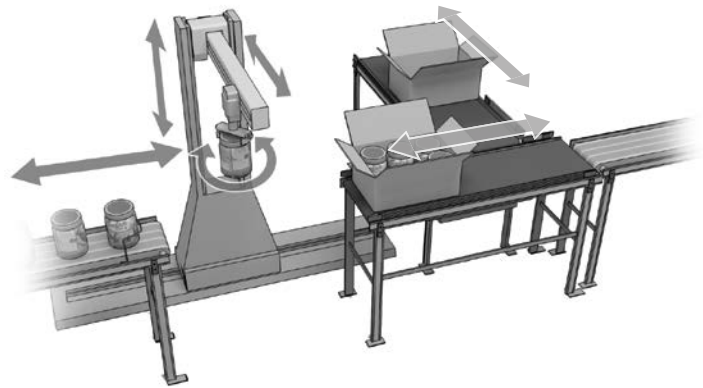
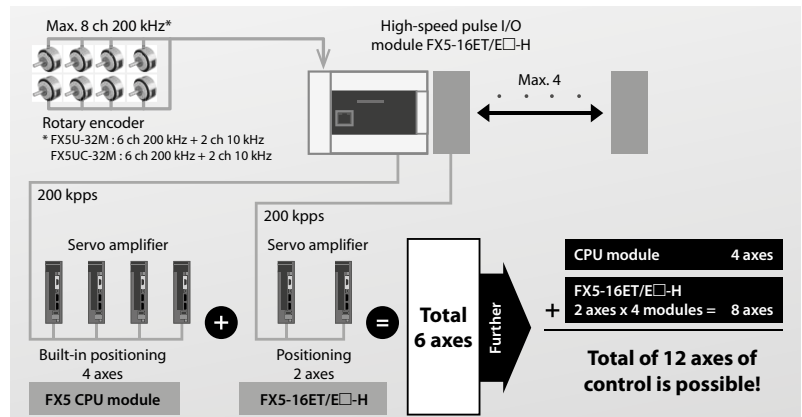

Packaging machine example with built-in positioning

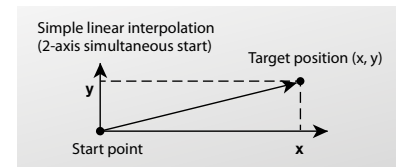
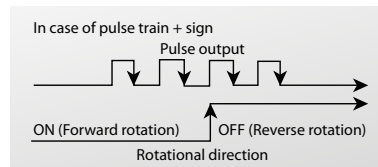

Simple Motion modules (4-axis/8-axis control modules)

FX3 series FX5 iQ-F series

Positioning control with SSCNET III/H

FX5-40SSC-S/FX5-80SSC-S are equipped with 4-axis/8-axis positioning functions compatible with SSCNET III/H. Positioning control is easily performed with a sequence program starting positioning data of a point table.

To respond to extensive applications, various positioning controls are available: Linear interpolation, 2-axis circular interpolation, fixed-pitch feed, and continuous trajectory controls, etc.

- Linear interpolation
- Circular interpolation
- Continuous trajectory control
- S-curve acceleration/deceleration

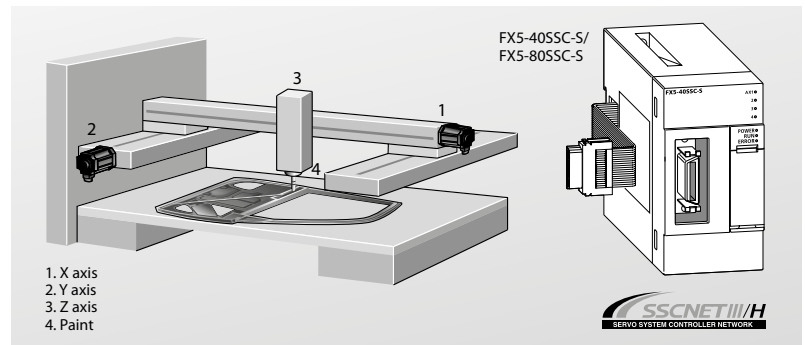

Basic positioning control

FX3 series FX5 iQ-F series

Positioning control is easily performed with a sequence program starting positioning data of a point table. To respond to extensive applications, various positioning controls are available: Linear interpolation, 2-axis circular interpolation, fixed-pitch feed, and continuous trajectory controls, etc.

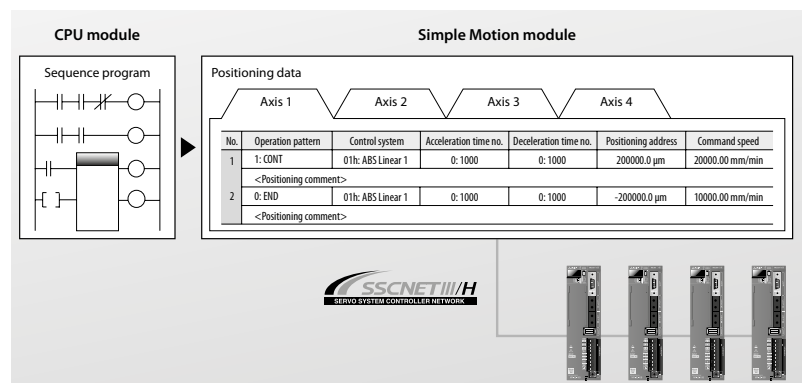

■ **Advanced motion control**

□ FX3 series FX5 iQ-F series

Making Simple Motion with compactly packed extra functions

Similar to positioning modules, Simple Motion modules are capable of a wide range of high-precision control such as positional control, advanced synchronous control, cam control, and speed-torque control with setup being done easily by parameters and programming.

Synchronous control

In addition to synchronous control that replaces physical machine mechanisms such as gears, shaft, transmission and cam with software, functions such as cam control, clutch and cam auto-generation are easily realized. Since synchronous control can be started and stopped for each axis, programs can contain both synchronous control axes and positioning control axes.

Up to four axes can be synchronized to the synchronous encoder axis, enabling use with a variety of systems.

- Use synchronous control and cam control to build a system perfect for your equipment.
- Register up to 64 types of cam patterns to respond to any type of packaging needs.
- Perform continuous operation without stopping the workpiece operation.

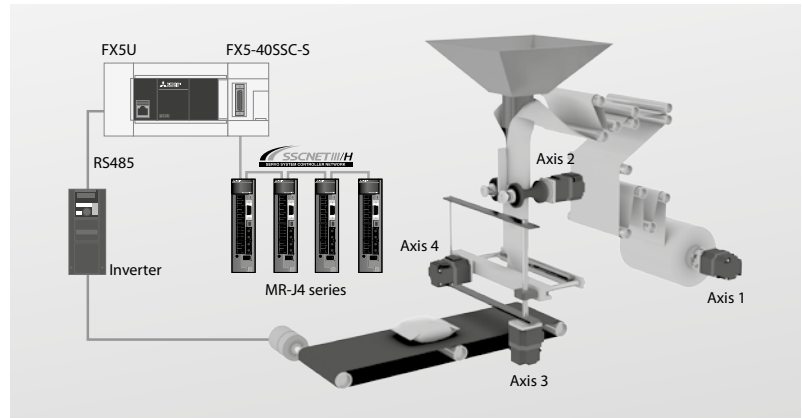

Packaging machine with Simple Motion

Mark detection function

The cutter axis deviation can be compensated by detecting a mark on the workpiece so the workpiece can be cut at a constant position.

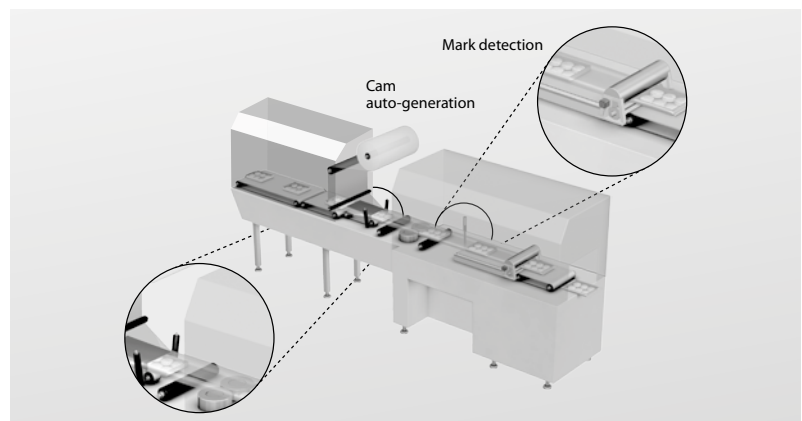

Rotary cutter control with mark detection and cam data

Cam data auto-generation

Easily program and automatically generate difficult cam data for rotary cutters just by inputting the sheet length, synchronization width, and cam resolution, etc.

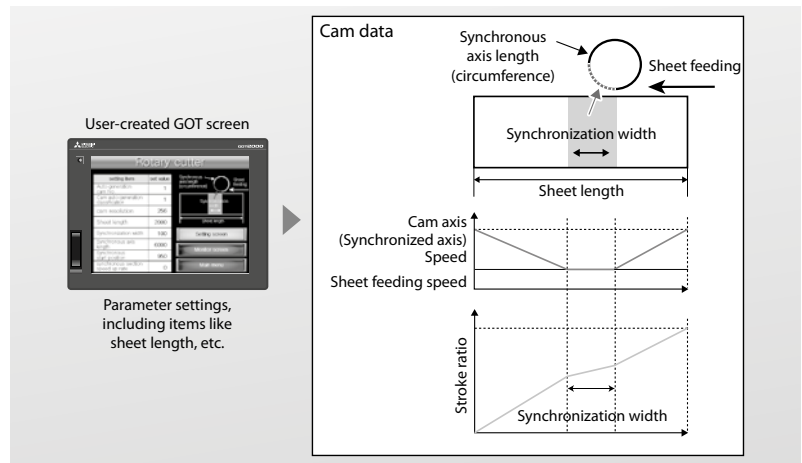

MELSEC-F built-in functions

FX control solutions

FX3 series FX5 iQ-F series

Positioning

Built-in high-speed pulse outputs and special instructions enable the FX series main units to control up to 3 independent axes of servo motion from the main unit itself at up to 100 kHz. Connecting two high-speed output special adapters to the FX3U allows for up to 4 axes of control at up to 200 kHz.*

With special function blocks, interpolated and networked servo control solutions are also available.

Analog control

The FX series features easy analog to digital and digital to analog conversion for all models using expansion boards, special adapters or special function blocks.

Information exchange

Information can be sent to a higher level PC that constantly monitors production, raising the reliability and overall efficiency of the system.

High-speed control

With 6 to 8 high-speed counters on each model, the FX series is perfectly suited for applications in need of pulse-catch functions, closed-loop feedback processing or high-speed sensor use.

Open Field networks

Among the networks supported by the FX series are CC-Link and Ethernet, Modbus® and Profibus, providing both a wide selection for new solutions and an interface into existing networks.

Data management

A special adapter, the FX3U-CF-ADP, for the FX3U and FX3UC enables data to be automatically written to a CF card at specified intervals or under certain conditions. The data is saved in universal CSV format with user-defined file names and automatic timestamps to enhance efficiency.

Inverter control

FX3 series PLCs contain the RS485 communication protocol and special instructions that allow control of all Mitsubishi Electric FREQROL inverters. For all other models, analog inverter control can be used.

Serial communication

From PCs, printers, barcode readers, modems and other PLCs, serial communication increases the flexibility of the FX series system to allow reliable data exchange over a variety of connections.

Visualization

HMI options for the FX series range from simple text-based display units to advanced graphical touch-screen displays (GOT – Graphic Operation Terminals).

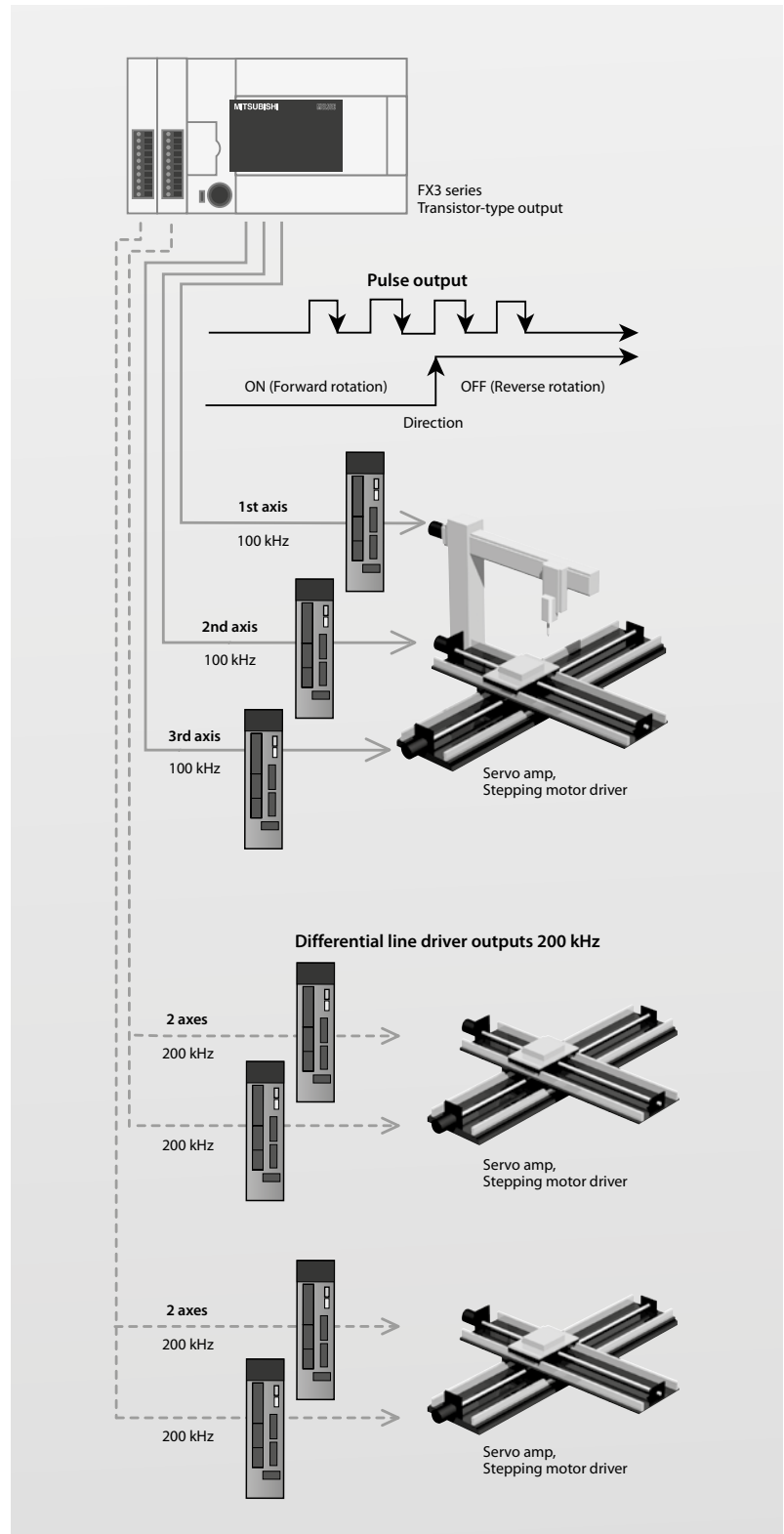

Upgraded built-in positioning instructions for easier use

* When using high-speed output special adapters, the same numbered I/O terminals on the PLC main unit may not be used.

MELSEC iQ-F

The MELSEC FX5U series

2
FX base units

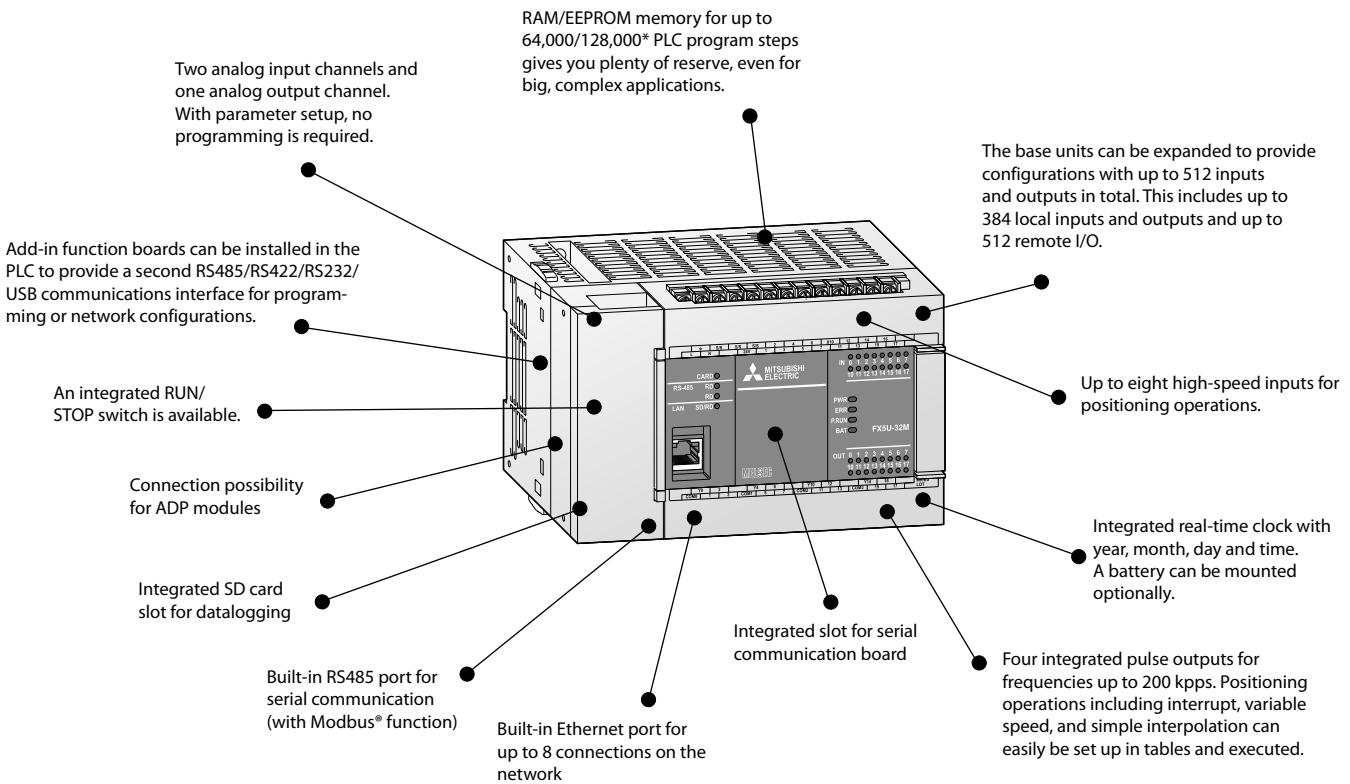

* Scan time will increase when using the 128 k step mode on FX5.

Description of the unit components

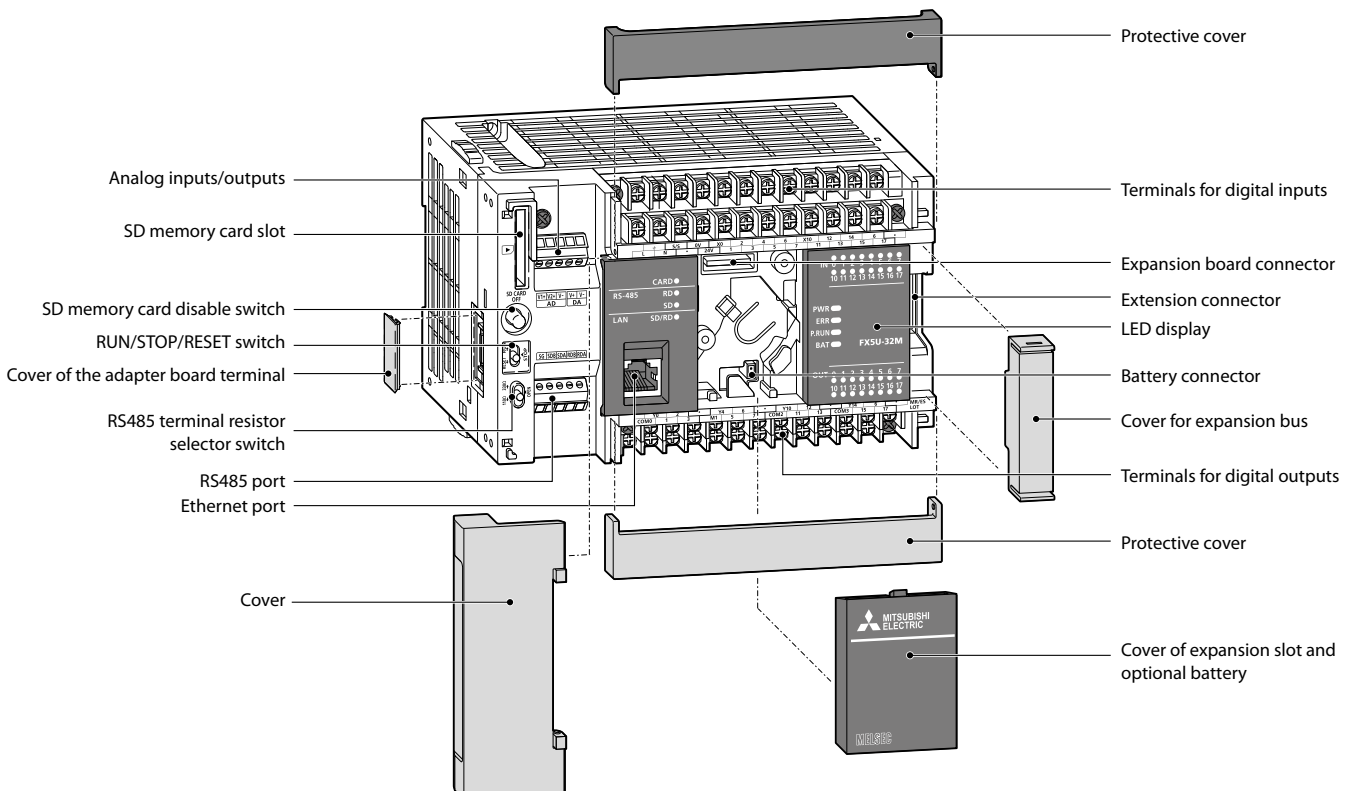

Base units

FX3S FX3G FX3GC FX3GE FX3U FX3UC FX5U FX5UC

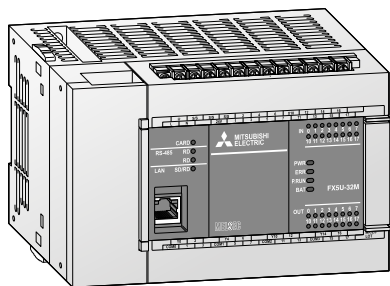

Base units FX5U

The FX5U series CPU modules feature outstanding performance and superior drive control.

- High-speed system bus
- Built-in Ethernet port
- Built-in analog inputs/outputs
- Built-in positioning (200 kpps, 4-axis)
- Built-in RS485 port (with Modbus* function)
- Built-in SD card slot
- Advanced security functions
- Battery-less and maintenance free
- Connection of FX5 and various FX3 expansion modules possible
- Connection of connector type FX5 I/O modules possible

Base units with 32–80 I/Os

Specifications	FX5U-32MR/DS	FX5U-32MT/DSS	FX5U-32MR/ES	FX5U-32MT/ESS
Integrated inputs/outputs	32			
Power supply	24 V DC		100–240 V AC	
Integrated inputs	16			
Integrated outputs	16			
Output type	Relay	Transistor (source type)*	Relay	Transistor (source type)*
Power consumption	W 30			
Weight	kg 0.7			
Dimensions (WxHxD)	mm 150x90x83			
Order information	Art. no. 297436	297438	280489	280491

Specifications	FX5U-64MR/DS	FX5U-64MT/DSS	FX5U-64MR/ES	FX5U-64MT/ESS
Integrated inputs/outputs	64			
Power supply	24 V DC		100–240 V AC	
Integrated inputs	32			
Integrated outputs	32			
Output type	Relay	Transistor (source type)*	Relay	Transistor (source type)*
Power consumption	W 40			
Weight	kg 1.0			
Dimensions (WxHxD)	mm 220x90x83			
Order information	Art. no. 301923	301945	280492	280494

Specifications	FX5U-80MR/DS	FX5U-80MT/DSS	FX5U-80MR/ES	FX5U-80MT/ESS
Integrated inputs/outputs	80			
Power supply	24 V DC		100–240 V AC	
Integrated inputs	40			
Integrated outputs	40			
Output type	Relay	Transistor (source type)*	Relay	Transistor (source type)*
Power consumption	W 45			
Weight	kg 1.2			
Dimensions (WxHxD)	mm 285x90x83			
Order information	Art. no. 301946	301948	280495	280497

* Sink type transistor output units on request.

Specifications

FX3S FX3G FX3GC FX3GE FX3U FX3UC FX5U FX5UC

Environmental specifications

General specifications	Data
Ambient temperature	-20–55 °C (storage temperature: -25–75 °C)
Noise durability	1000 Vpp with noise generator; 1 µs at 30–100 Hz
Dielectric withstand voltage	AC PSU: 1500 V AC, 1 min./DC PSU: 500 V AC, 1 min.
Ambient relative humidity	5–95 % (non-condensing)
Shock resistance	Acc. to IEC61131-2: 147 m/s ² (3 times each in 3 directions for 11 ms)
Vibration resistance	Acc. to IEC61131-2: 9.8 m/s ² (resistance to vibrations from 5–150 Hz for 80 minutes along all 3 axes); 4.9 m/s ² for DIN rail mounting
Insulation resistance	10 MΩ, 500 V DC
Ground	Class D: Grounding resistance 100 Ω or less
Fuse rating	AC powered types: FX5U-32M□: 3.15 A; FX5U-64M□ and FX5U-80M□: 5 A, DC powered types: 3.15 A
Environment	Avoid environments containing corrosive gases, install in a dust-free location.
Certifications	Please refer to pages 109–111

Electrical specifications

Power supply specifications	DC powered modules (FX5U-□IM□/DS/DSS)	AC powered modules (FX5U-□MR/ES)
Power supply	24 V DC (+20 %/-15%)	100–240 V AC (+10 %/-15 %), 50/60 Hz
Inrush current at ON	50 A/<0.5 ms (at 24 V DC)	FX5U-32M: 25 A/<5 ms (at 100 V AC); 50 A/<5 ms (at 200 V AC); FX5U-64M, FX5U-80M: 30 A/<5 ms (at 100 V AC); 60 A/<5 ms (at 200 V AC)
Allowable momentary power failure time	5 ms	10 ms
Service power supply (24 V DC)	—	FX5U-32M□/E: 480 mA FX5U-64M□/E: 740 mA FX5U-80M□/E: 770 mA

Programming specifications

System specifications	FX5U
Program data	
I/O points (addresses)	Max. total 512 (with remote I/O)
Program memory	64,000/128,000* steps RAM (internal)
Instruction processing time	34 ns/basic instruction
Programming language	Ladder diagram (LD), structured text (ST), function block diagram/ladder diagram (FBD/LD)
Program execution	Cyclical execution, refresh mode processing

* Scan time will increase when using the 128 k step mode on FX5

The MELSEC FX5UC series

RAM/EEPROM memory for up to 64,000/128,000* PLC program steps gives you plenty of reserve, even for big, complex applications.

An integrated RUN/STOP switch is available.

Connection possibility for ADP modules

Built-in RS485 port for serial communication (with Modbus® function)

Built-in Ethernet port for up to 8 connections on the network

The base units can be expanded to provide configurations with up to 512 inputs and outputs in total. This includes up to 384 local inputs and outputs and up to 512 remote I/O.

Up to eight high-speed inputs for positioning operations.

Integrated real-time clock with year, month, day and time

Four integrated pulse outputs for frequencies up to 200 kpps. Positioning operations including interrupt, variable speed, and simple interpolation can easily be set up in tables and executed.

* Scan time will increase when using the 128 k step mode on FX5.

Description of the unit components

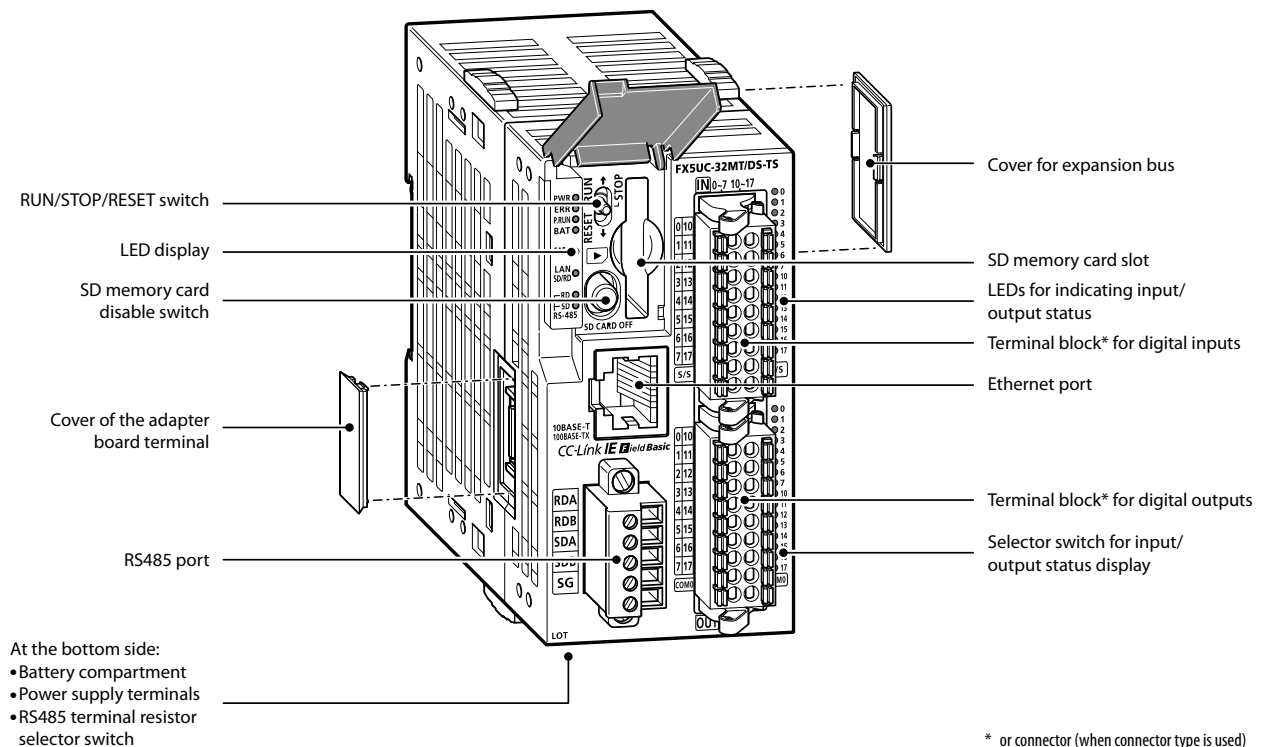

* or connector (when connector type is used)

■ Base units

- FX3S FX3G FX3GC FX3GE FX3U FX3UC FX5U FX5UC

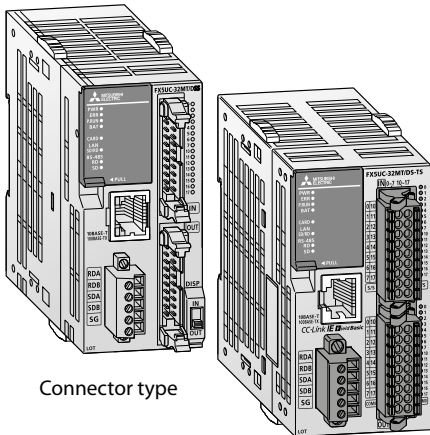

Connector type

Spring clamp terminal block type

Base units FX5UC

The FX5UC series CPU modules feature outstanding performance and superior drive control.

- High-speed system bus
- Built-in Ethernet port
- Built-in positioning (200 kpps, 4-axis)
- Built-in RS485 port (with Modbus® function)
- Built-in SD card slot
- Advanced security functions
- Battery-less and maintenance free
- Connection of FX5 and various FX3 expansion modules possible
- Easy and quick wiring with spring clamp I/O

Base units with 32–96 I/Os

Specifications	FX5UC-32MR/DS-TS ①	FX5UC-32MT/DSS	FX5UC-32MT/DSS-TS ①	FX5UC-64MT/DSS	FX5UC-96MT/DSS
Integrated inputs/outputs	32			64	96
Power supply	24 V DC				
Integrated inputs	16			32	48
Integrated outputs	16			32	48
Output type	Relay	Transistor (source type)*			
Power consumption	W 5			8	11
Weight	kg 0.2		0.25	0.3	0.35
Dimensions (WxHxD)	mm 68.2x90x93.7	42.1x90x89.1	48.1x90x93.7	62.2x90x89.1	82.3x90x89.1
Order information	Art. no. 413832	283530	315551	294579	294581

* Sink type transistor output units on request.

① Spring clamp terminal block type

System cabling

Terminal blocks with screw or spring terminals are available for easy wiring of the FX5UC modules with standard ribbon cable connectors.

For detailed information about the terminal blocks, please refer to chapter accessories.

Example 1

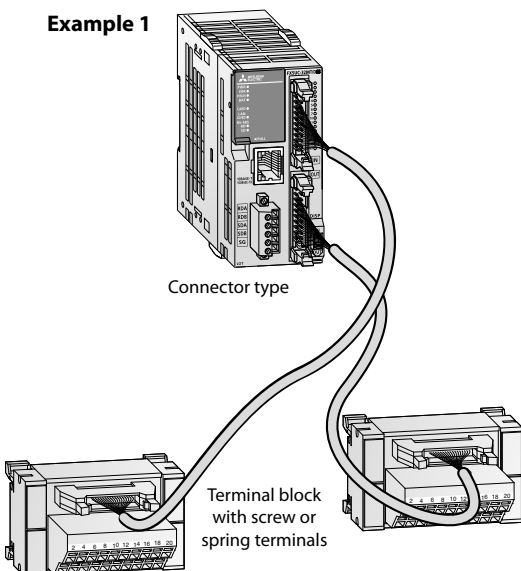

Example 2

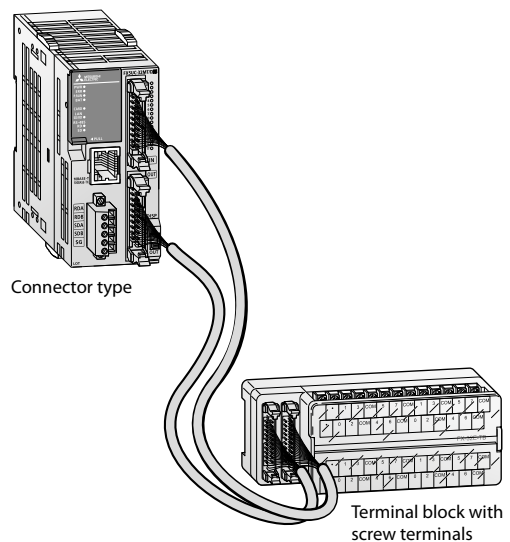

Specifications

FX3S FX3G FX3GC FX3GE FX3U FX3UC FX5U FX5UC

Environmental specifications

General specifications	Data
Ambient temperature	-20–55 °C (storage temperature: -25–75 °C)
Noise durability	1000 Vpp with noise generator; 1 µs at 30–100 Hz
Dielectric withstand voltage	500 V AC, 1 min.
Ambient relative humidity	5–95 % (non-condensing)
Shock resistance	Acc. to IEC61131-2: 147 m/s ² (3 times each in 3 directions for 11 ms)
Vibration resistance	Acc. to IEC61131-2: 4.9 m/s ² (resistance to vibrations from 8.4–150 Hz for 80 minutes along all 3 axes); 4.9 m/s ² for DIN rail mounting
Insulation resistance	≥10 MΩ, 500 V DC
Ground	Class D: Grounding resistance 100 Ω or less
Fuse rating	3.15 A
Environment	Avoid environments containing corrosive gases, install in a dust-free location.
Certifications	Please refer to pages 109–111

Electrical specifications

Power supply specifications	DC powered modules
Power supply	24 V DC (+20 %/-15 %)
Inrush current at ON	FX5UC-32MT/□: 35 A/<0.5 ms (at 24 V DC) FX5UC-64MT/□, FX5UC-96MT/□: 40 A/<0.5 ms (at 24 V DC)
Allowable momentary power failure time	5 ms
Service power supply (24 V DC)	—

Programming specifications

System specifications	FX5UC
Program data	
I/O points (addresses)	Max. total 512 (with remote I/O)
Program memory	64,000/128,000* steps RAM (internal)
Instruction processing time	34 ns/basic instruction
Programming language	Ladder diagram (LD), structured text (ST), function block diagram/ladder diagram (FBD/LD)
Program execution	Cyclical execution, refresh mode processing

* Scan time will increase when using the 128 k step mode on FX5

MELSEC-F

The MELSEC FX3S series

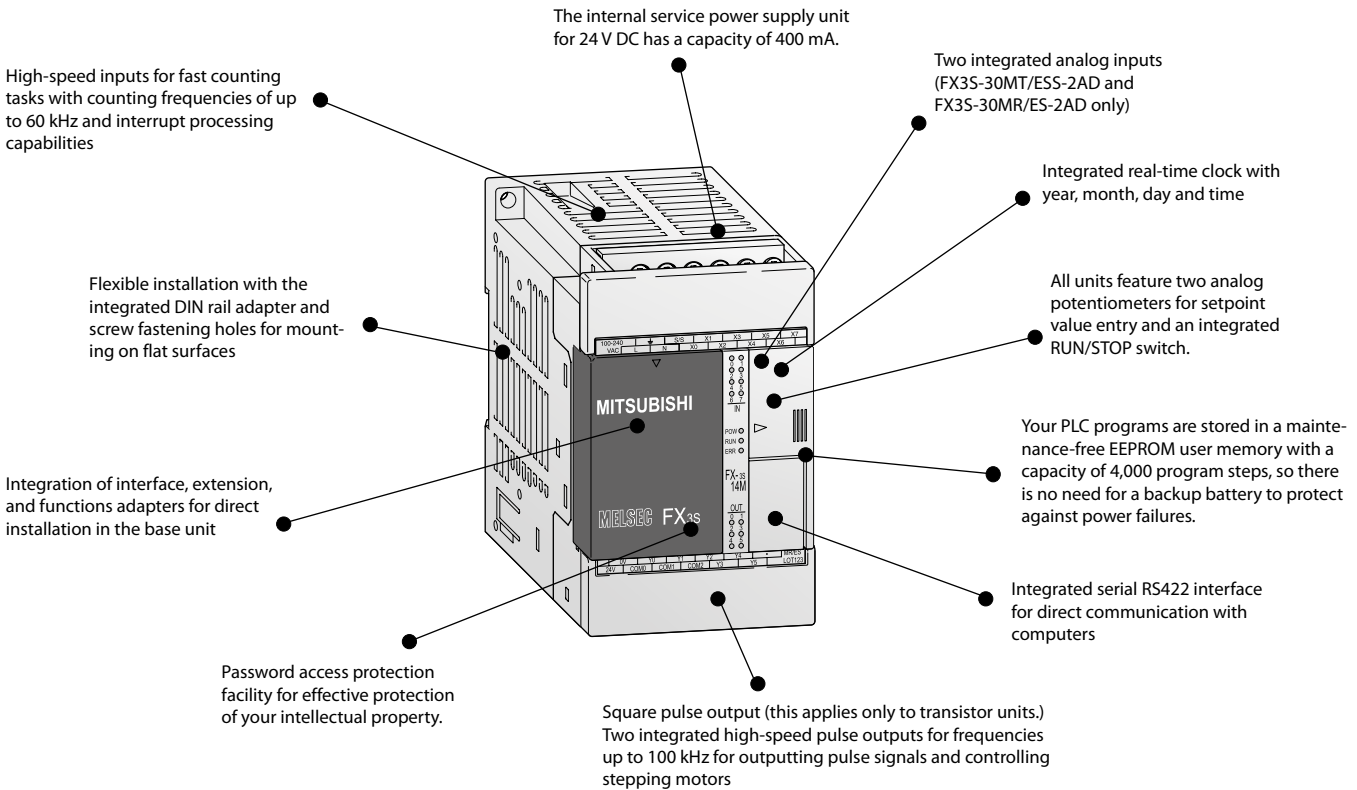

Description of the unit components

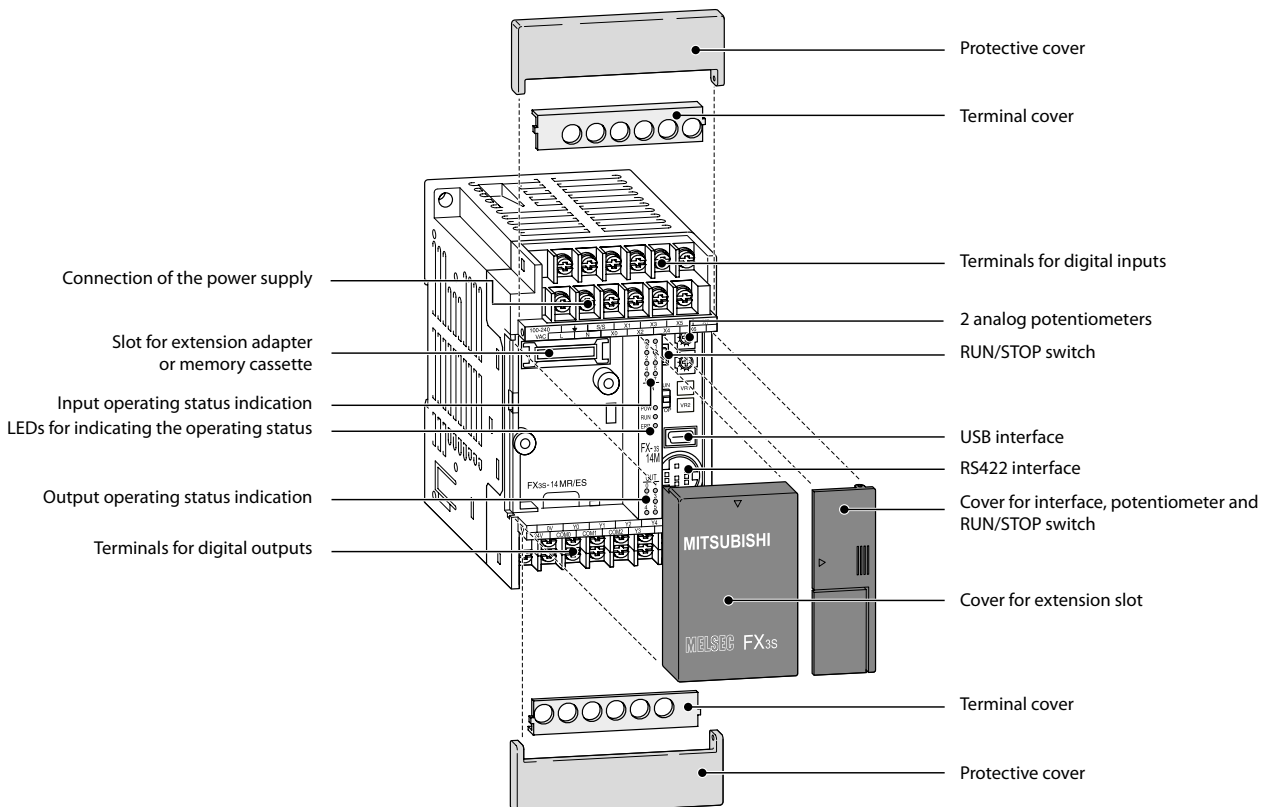

■ Base units

FX3S FX3G FX3GC FX3GE FX3U FX3UC FX5U FX5UC

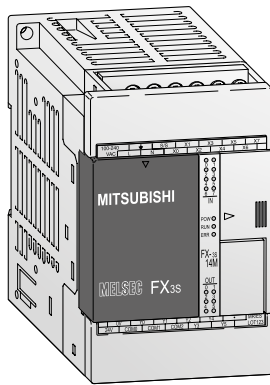

Base units FX3S

The FX3S series base units are available with 10 to 30 input/output points.

It is possible to choose between relay and transistor output type.

- Integrated power supply (AC or DC powered)
- Maintenance-free EEPROM memory
- Ample memory capacity (4000 steps) and device ranges
- High-speed operations
- Incorporated positioning control
- Integrated real-time clock

- FX3S-30MT/ESS-2AD and FX3S-30MR/ES-2AD with two integrated analog inputs (0–10 V DC)
- System upgrades by exchangeable interface and I/O adapter boards for direct fitting into the base unit
- LEDs for indicating the input and output status
- Standard programming unit interface
- User-friendly programming systems, including IEC 61131-3 (EN 61131-3)-compatible programming software, HMIs and hand-held programming units

Base units with 10–14 I/Os

Specifications	FX3S-10 MR/ES	FX3S-10 MR/DS	FX3S-10 MT/ESS	FX3S-10 MT/DSS	FX3S-14 MR/ES	FX3S-14 MR/DS	FX3S-14 MT/ESS	FX3S-14 MT/DSS	
Integrated inputs/outputs	10				14				
Power supply	100–240 V AC	24 V DC	100–240 V AC	24 V DC	100–240 V AC	24 V DC	100–240 V AC	24 V DC	
Integrated inputs	6				8				
Integrated outputs	4				6				
Output type	Relay		Transistor (source)*		Relay		Transistor (source)*		
Power consumption	W	19	6	19	6	19	6,5	19	6,5
Weight	kg	0.30							
Dimensions (WxHxD)	mm	60x90x75	60x90x49	60x90x75	60x90x49	60x90x75	60x90x49	60x90x75	60x90x49
Order information	Art. no.	267110	271687	267112	271695	267113	271688	267125	271696

Base units with 20–30 I/Os

Specifications	FX3S-20 MR/ES	FX3S-20 MR/DS	FX3S-20 MT/ESS	FX3S-20 MT/DSS	FX3S-30 MR/ES	FX3S-30 MR/DS	FX3S-30 MR/ES-2AD	FX3S-30 MT/ESS	FX3S-30 MT/ESS-2AD	FX3S-30 MT/DSS	
Integrated inputs/outputs	20				30						
Power supply	100–240 V AC	24 V DC	100–240 V AC	24 V DC	100–240 V AC	24 V DC	100–240 V AC			24 V DC	
Integrated inputs	12				16						
Integrated outputs	8				14						
Output type	Relay		Transistor (source)*		Relay		Transistor (source)*				
Power consumption	W	20	7	20	7	21	8,5	21		8,5	
Weight	kg	0.40									
Dimensions (WxHxD)	mm	75x90x75	75x90x49	75x90x75	75x90x49	100x90x75	100x90x49	100x90x75		100x90x49	
Order information	Art. no.	267126	271689	267128	271697	267129	271690	271654	267131	271686	271698

* Sink type transistor output units on request.

Specifications

FX3S FX3G FX3GC FX3GE FX3U FX3UC FX5U FX5UC

Environmental specifications

General specifications	Data
Ambient temperature	0–55 °C (storage temperature: -25–75 °C)
Noise durability	1,000 Vpp with noise generator; 1 μs at 30–100 Hz
Dielectric withstand voltage	1,500 V AC, 1 min
Ambient relative humidity	5–95 % (non-condensing)
Shock resistance	Acc. to IEC 68-2-27: 15 g (147 m/s ²) (3 times each in 3 directions for 11 ms)
Vibration resistance	Acc. to IEC 68-2-6: 1 g (resistance to vibrations from 57–150 Hz for 80 minutes along all 3 axes); 0.5 g for DIN rail mounting
Insulation resistance	5 MΩ at 500 V DC
Ground	Class D: Grounding resistance 100 Ω or less
Fuse rating	250 V 1.0 A
Environment	Avoid environments containing corrosive gases, install in a dust-free location.
Certifications	Please refer to pages 109–111

Electrical specifications

Power supply specifications	AC powered modules (FX-3S-□M□/E□)
Power supply	100–240 V AC (+10 %/-15 %), 50/60 Hz
Inrush current at ON	30 A/<5 ms (at 100 V AC); 50 A/<5 ms (at 200 V AC)
Allowable momentary power failure time	10 ms
Primary power supply	—
External power supply (24 V DC)	400 mA

Output specifications	Relay module	Transistor module
Switching voltage (max.)	V <240 V AC, <30 V DC	5–30 V DC
Max. output current	- per output A 2 - per group ^② A 8	0.5 0.8
Max. switching current	- inductive load	80 VA 12 W
Response time	ms 10	<0.2 (<5 μs for Y0, Y1)
Life of contacts (switching times) ^①	3,000,000 at 20 VA; 1,000,000 at 35 VA; 200,000 at 80 VA	

① Not guaranteed by Mitsubishi Electric

② The limitation applies only per reference terminal for each group with 4 outputs. Please observe the terminal assignments for the group identification

Programming specifications

System specifications	FX3S	
Program data		
I/O points (addresses)	30 total	
Address range	Max. 30 direct addressing	
Program memory	16,000 steps EEPROM, (Program capacity is 4,000 steps.)	
Instruction time	Basic instructions	0.21 μs/instruction
	Applied instructions	0.5 μs to several hundred μs/instruction
Number of instructions	29 sequence instructions, 2 step ladder instructions, 116 applied instructions	
Programming language	Simple project	Ladder, SFC, ST (Structured Text)
	Structured project	Structured Ladder/FBD, SFC, ST
Program execution	Cyclical execution, refresh mode processing	
Program protection	2 different keywords, max. password length 16 characters	

System specifications	FX3S
Operands	
Auxiliary relays	1,536 total, with 1,408 general (M0–M383 and M512–M1535) and 128 EEPROM latched (M384–M511)
Special auxiliary relays	512 (M8000–M8511)
State relays	256 total, with 128 EEPROM latched (S0–S127) and 128 general (S128–S255)
Timer	169 total, with 69 100 ms (T0–T62 and T132–T137), 31 100/10 ms (T32–T62), and 69 1 ms (T63–T131)
External setpoint entry via potentiometer	2
Counter	67 total (16 bit and 32 bit), with 51 general (C0–C15 and C200–C234) and 16 EEPROM latched (C16–C31)
High-speed counter	21 total, with 16 1-phase (C235–C250) and 5 2-phase (C251–C255)
High-speed counter speed	1-phase, 6 points max: 60 kHz/2 points, 10 kHz/4 points 2-phase, 2 points max: 30 kHz/1 point, 5 kHz/1 point
Real-time clock	Year, month, day, hour, minute, second, weekday
Data registers	3,000 total, with 2,872 general (D0–D127 and D256–D2999) and 128 EEPROM latched (D128–D255)
Extension registers	—
Extension file registers	—
Index registers	16
Special data registers	512 (D8000–D8511)
Pointer	256
Nestings	8
Interrupt inputs	6
Constants	16 bit: K: -32,768 to +32,767; H: 0 to FFFF
	32 bit: K: -2,147,483,648 to +2,147,483,647; H: 0 to FFFF FFFF

The MELSEC FX3G series

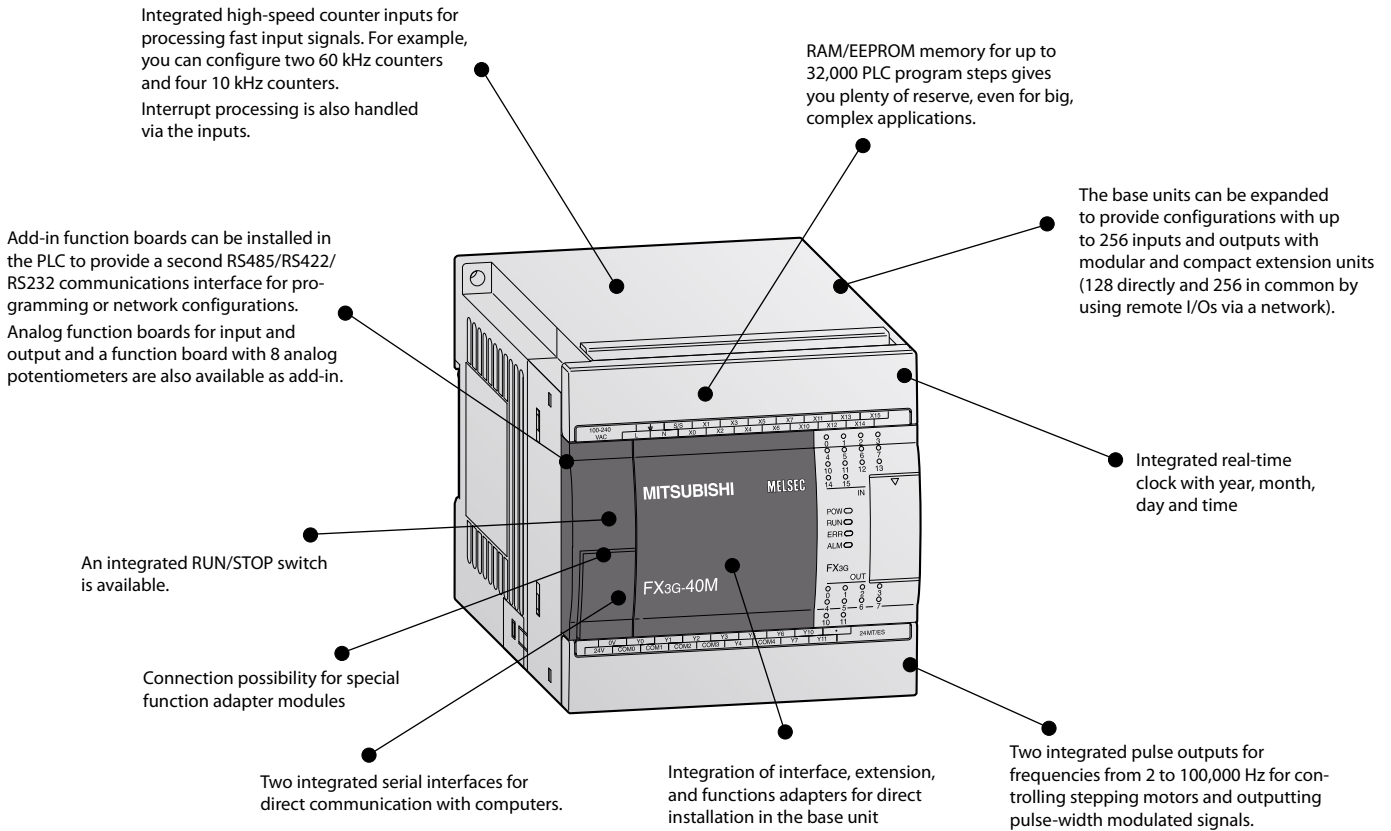

Description of the unit components

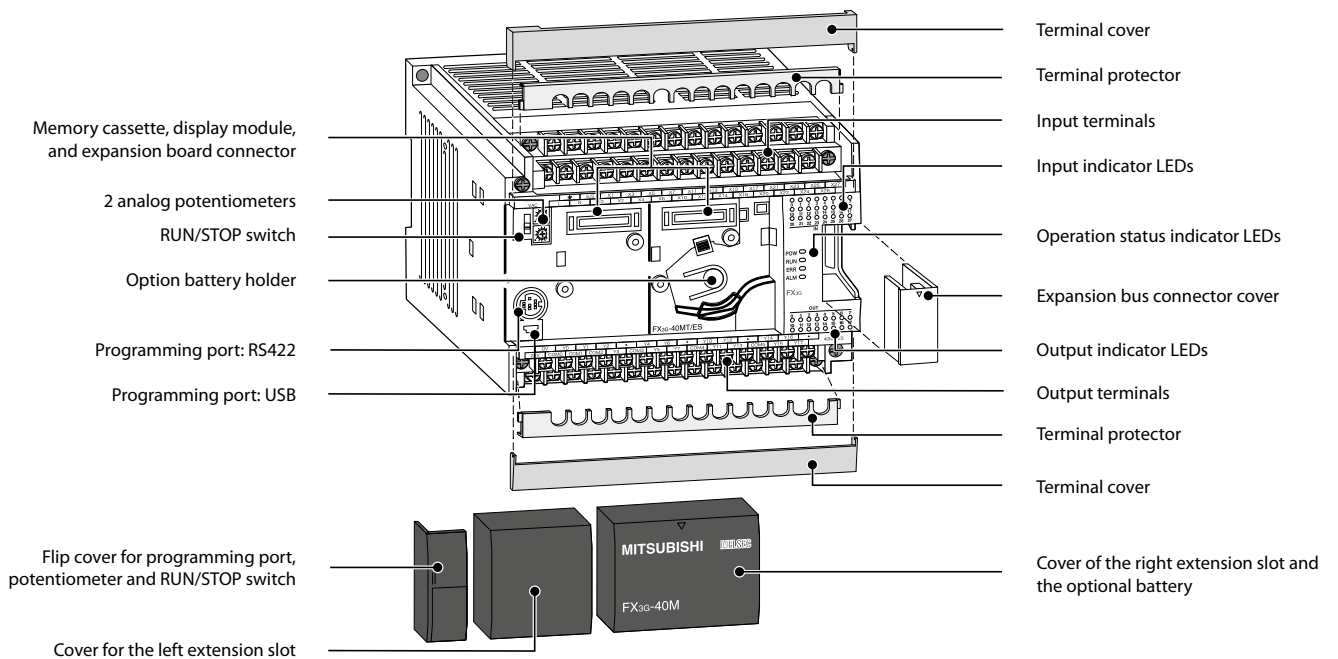

■ Base units

- FX3S **FX3G** FX3GC FX3GE FX3U FX3UC FX5U FX5UC

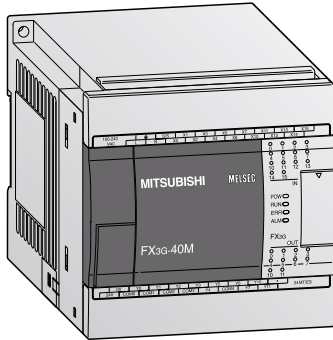

Base units FX3G

The FX3G series base units are available with 14 to 60 input/output points. It is possible to choose between relay and transistor output types.

- Integrated USB interface for communication between PLCs and PC
- Integrated serial interface for communication between PCs and HMI
- LEDs for indicating the input and output status
- Detachable terminal blocks for all units
- Slot for memory cassettes
- Integrated real-time clock
- Integrated positioning control
- Exchangeable interface and extension adapters for direct mounting into a base unit
- Expandable with digital I/O modules, special function modules and ADP modules
- User-friendly programming systems, including IEC 61131-3 (EN 61131-3) compatible programming software, HMIs and hand-held programming units

Base units with 14–24 I/Os

Specifications	FX3G-14 MR/ES	FX3G-14 MT/ESS	FX3G-14 MR/DS	FX3G-14 MT/DSS	FX3G-24 MR/ES	FX3G-24 MT/ESS	FX3G-24 MR/DS	FX3G-24 MT/DSS	
Integrated inputs/outputs	14				24				
Power supply	100–240 V AC			24 V DC	100–240 V AC			24 V DC	
Integrated inputs	8				14				
Integrated outputs	6				10				
Output type	Relay	Transistor (source)*	Relay	Transistor (source)*	Relay	Transistor (source)*	Relay	Transistor (source)*	
Power consumption	W	31		19	W	32		21	
Weight	kg	0.50			kg	0.55			
Dimensions (WxHxD)	mm	90x90x86							
Order information	Art. no.	231466	231470	231474	231478	231467	231471	231475	231479

Base units with 40–60 I/Os

Specifications	FX3G-40 MR/ES	FX3G-40 MT/ESS	FX3G-40 MR/DS	FX3G-40 MT/DSS	FX3G-60 MR/ES	FX3G-60 MT/ESS	FX3G-60 MR/DS	FX3G-60 MT/DSS	
Integrated inputs/outputs	40				60				
Power supply	100–240 V AC			24 V DC	100–240 V AC			24 V DC	
Integrated inputs	24				36				
Integrated outputs	16				24				
Output type	Relay	Transistor (source)*	Relay	Transistor (source)*	Relay	Transistor (source)*	Relay	Transistor (source)*	
Power consumption	W	37		25	W	40		29	
Weight	kg	0.70			kg	0.85			
Dimensions (WxHxD)	mm	130x90x86			175x90x86				
Order information	Art. no.	231468	231472	231476	231480	231469	231473	231477	231481

* Sink type transistor output units on request.

The MELSEC FX3GE series

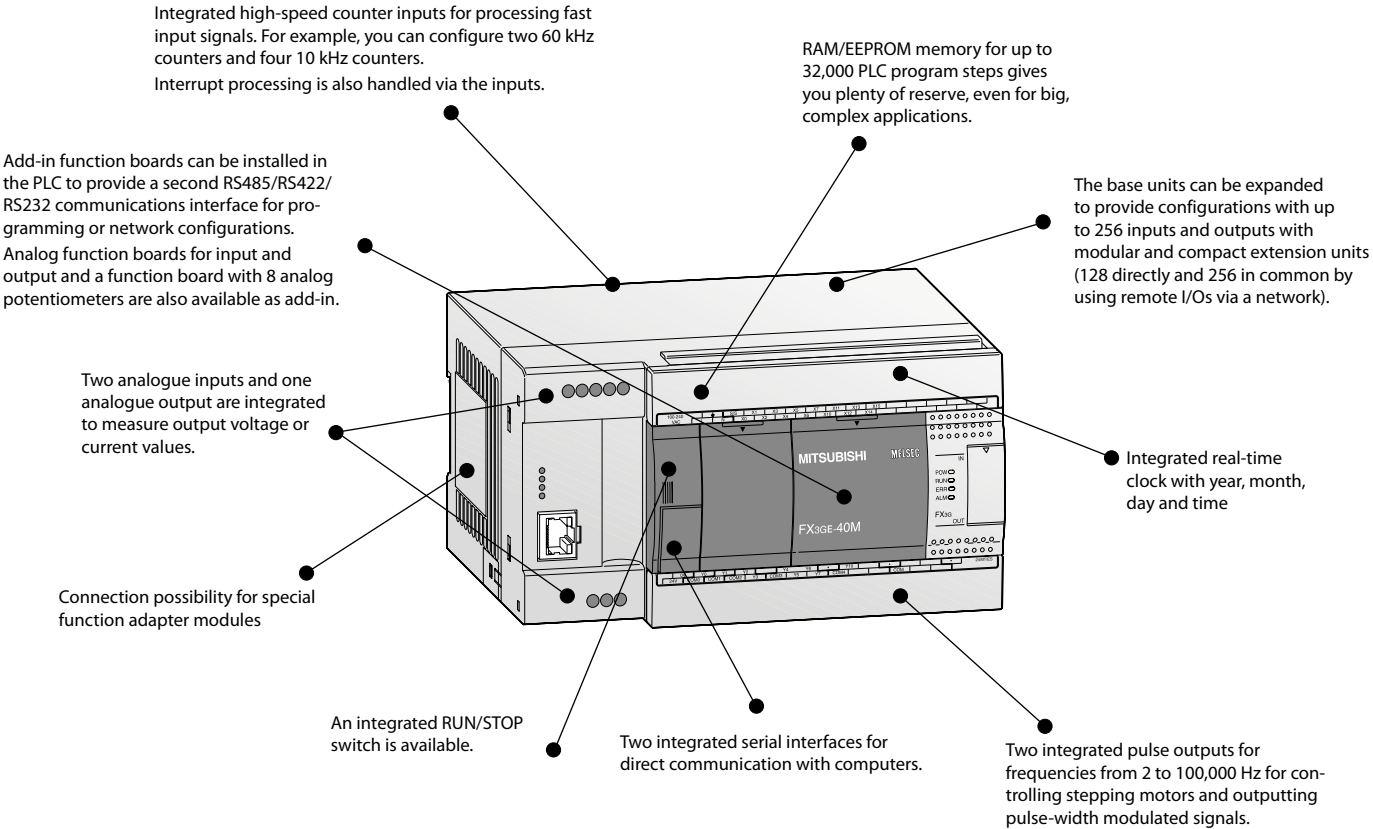

Description of the unit components

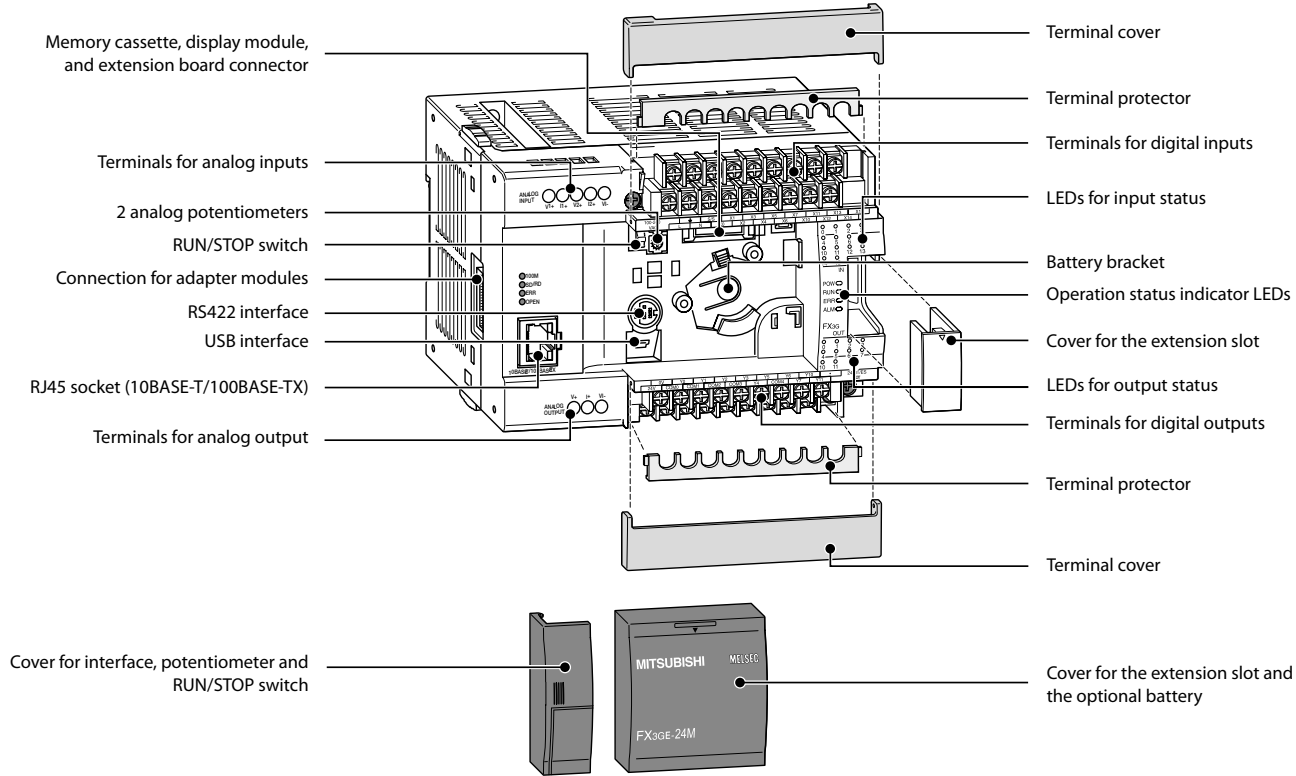

■ Base units

- FX3S FX3G FX3GC **FX3GE** FX3U FX3UC FX5U FX5UC

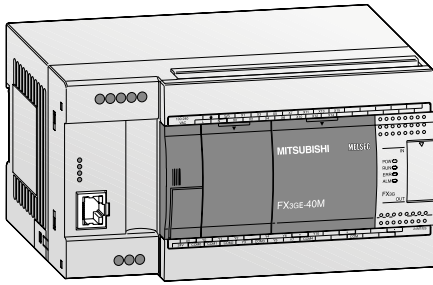

Base units FX3GE

The FX3GE series base units are available with 24 or 40 input/output points.

All base units are equipped with relay outputs.

- Integrated analog input (2 ch, voltage, current, 12 bit)
- Integrated analog output (1 ch, voltage, current, 12 bit)
- Integrated Ethernet interface
- Integrated USB interface for communication between PLC and PC
- Integrated serial interface for communication between PLC and HMI
- LEDs for indicating the input and output status
- Connection of inputs and outputs via terminals
- Slot for memory cassettes
- Integrated positioning control
- Expandable with special function modules and ADP modules
- User-friendly programming systems, including IEC 61131-3 (EN 61131-3) compatible programming software, HMIs and hand-held programming units

Base units with 24 I/Os

Specifications	FX3GE-24 MR/ES	FX3GE-24 MT/ESS	FX3GE-24 MR/DS	FX3GE-24 MT/DSS
Integrated inputs/outputs	24			
Power supply	100–240 V AC		24 V DC	
Integrated inputs	14			
Integrated outputs	10			
Output type	Relay	Transistor (source)*	Relay	Transistor (source)*
Power consumption	W	32	21	
Weight	kg	0.6	0.55	
Dimensions (WxHxD)	mm	130x90x86		
Order information	Art. no.	264869	269884	269917

Base units with 40 I/Os

Specifications	FX3GE-40 MR/ES	FX3GE-40 MT/ESS	FX3GE-40 MR/DS	FX3GE-40 MT/DSS
Integrated inputs/outputs	40			
Power supply	100–240 V AC		24 V DC	
Integrated inputs	24			
Integrated outputs	16			
Output type	Relay	Transistor (source)*	Relay	Transistor (source)*
Power consumption	W	37	25	
Weight	kg	0.8	0.70	
Dimensions (WxHxD)	mm	175x90x86		
Order information	Art. no.	264870	269916	269920

* Sink type transistor output units on request.

The MELSEC FX3GC series

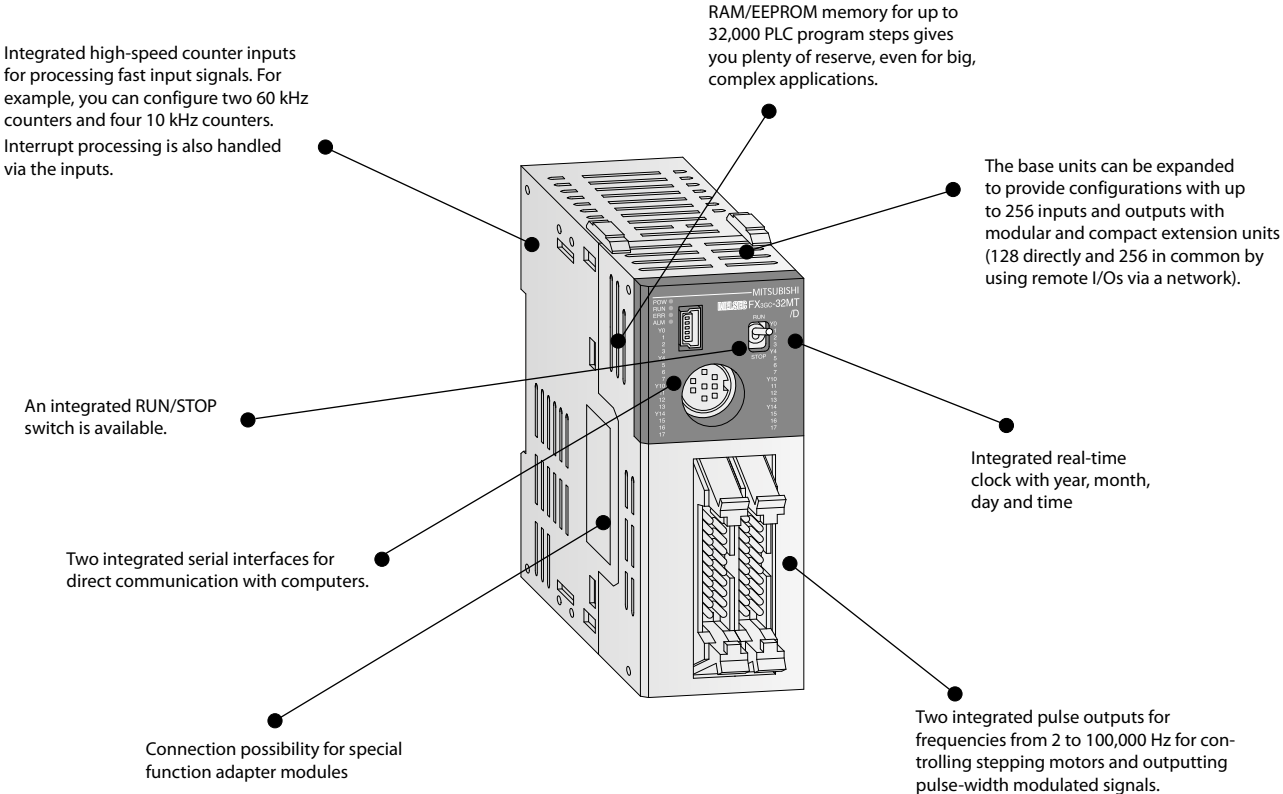

Description of the unit components

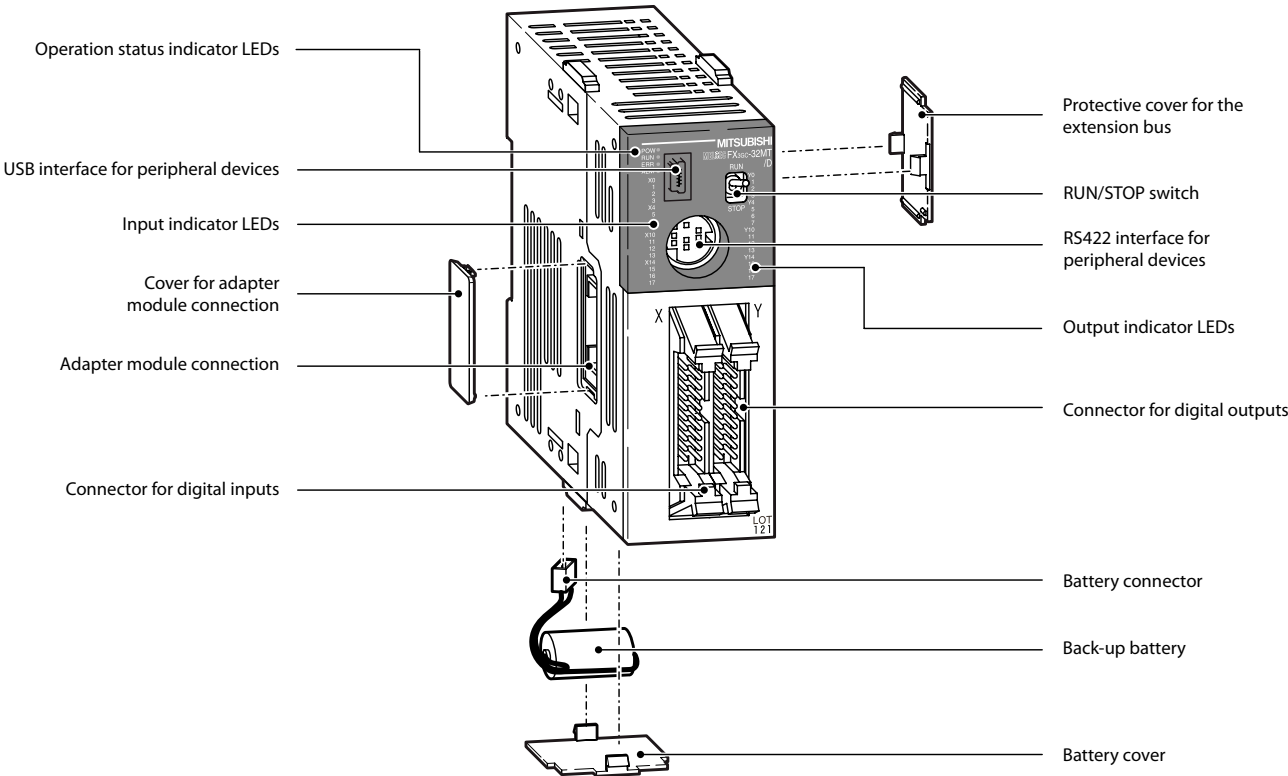

■ Base units

- FX3S FX3G FX3GC FX3GE FX3U FX3UC FX5U FX5UC

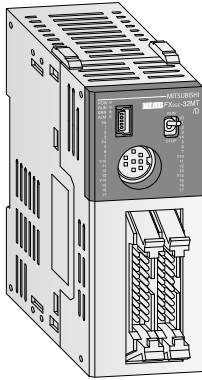

Base units FX3GC

The base units FX3GC-32 MT/□ are available with 32 input/output points.

The base units are equipped with transistor outputs.

- Integrated USB interface for communication between PLC and PC
- Integrated serial interface for communication between PLC and HMI
- LEDs for indicating the input and output status
- Connection of inputs and outputs via connectors.

- Integrated positioning control
- Expandable with digital I/O modules, special function modules and ADP modules
- User-friendly programming systems, including IEC 61131-3 (EN 61131-3) compatible programming software, HMIs and hand-held programming units

Base units with 32 I/Os

Specifications	FX3GC-32 MT/DSS	
Integrated inputs/outputs	32	
Power supply	24 V DC	
Integrated inputs	16	
Integrated outputs	16	
Output type	Transistor (source)*	
Power consumption	W	8
Weight	kg	0.2
Dimensions (WxHxD)	mm	34x90x87
Order information	Art. no.	251546

* Sink type transistor output units on request.

System cabling

Terminal blocks with screw or spring terminals are available for easy wiring of the FX3GC modules with standard ribbon cable connectors.

For detailed information about the terminal blocks, please refer to chapter accessories.

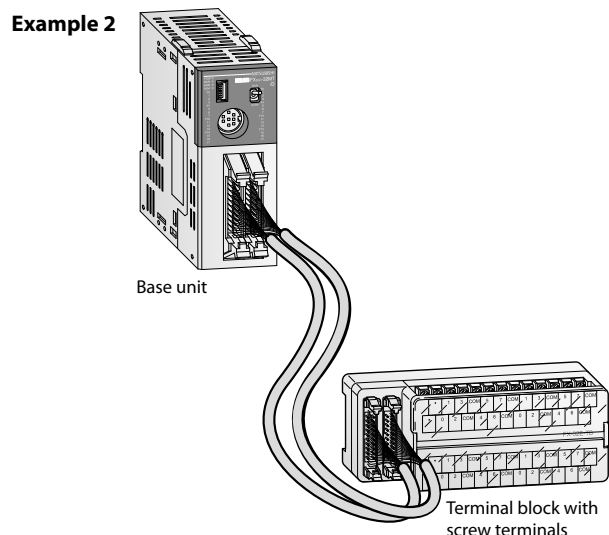
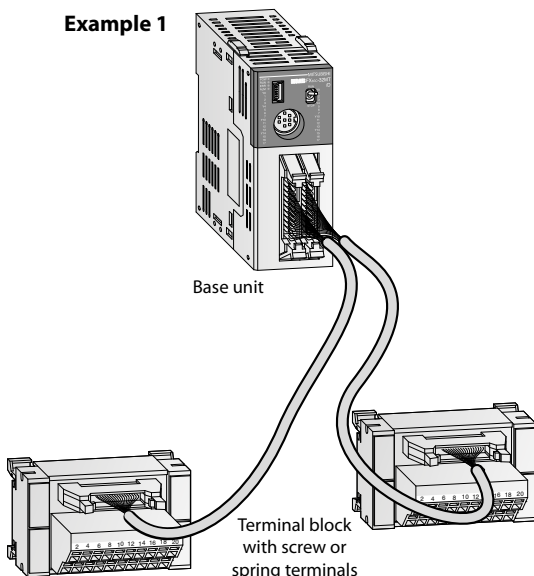

Specifications

FX3S FX3G FX3GC FX3GE FX3U FX3UC FX5U FX5UC

Environmental specifications

General specifications	FX3G	FX3GE	FX3GC
Ambient temperature	0–55 °C (storage temperature: –25–75 °C)		
Noise durability	1,000 Vpp with noise generator; 1 μs at 30–100 Hz		
Dielectric withstand voltage	1,500 V AC, 1 min		500 V AC, 1 min
Ambient relative humidity	5–95 % (non-condensing)		
Shock resistance	Acc. to IEC 68-2-27: 15 g (147 m/s ²) (3 times each in 3 directions for 11 ms)		
Vibration resistance	Acc. to IEC 68-2-6: 1 g (resistance to vibrations from 57–150 Hz for 80 minutes along all 3 axes); 0.5 g for DIN rail mounting		
Insulation resistance	5 MΩ, 500 V DC		
Ground	Class D: Grounding resistance 100 Ω or less		
Fuse rating	For FX3G-14M□ and FX3G-24M□: 250 V 1 A; For FX3G-40M□ and FX3G-60M□: 250 V 3.15 A	FX3GE-24M□: 250 V 1 A; FX3GE-40M□: 250 V 3.15 A	125 V 3.15 A
Environment	Avoid environments containing corrosive gases, install in a dust-free location.		
Certifications	Please refer to pages 109–111		

Electrical specifications

Power supply specifications	FX3G	FX3GE	FX3GC
Power supply	AC	100–240 V (+10 % / -15 %), 50/60 Hz	—
	DC	24 V DC (+20 % / -15 %)	—
Inrush current at ON	AC	30 A / <5 ms (at 100 V AC); 50 A / <5 ms (at 200 V AC)	—
	DC	30 A / <1 ms (at 24 V DC)	30 A / <0.5 ms (at 24 V DC)
Allowable momentary power failure time	10 ms		5 ms
External power supply (24 V DC)	400 mA		—

Output specifications	Relay modules FX3G/FX3GE	Transistor modules FX3G/FX3GE	Transistor modules FX3GC		
Switching voltage (max.)	V	<240 V AC, <30 V DC	5–30 V DC		
Max. output current	- per output	A	2	0.5	Y000, Y001: 0.3 Y002–Y017: 0.1
	- per group	A	8 ^②	0.8 ^②	0.8
Max. switching current	- inductive load	W	80 VA	12 W	Y000, Y001: 7.2 Y002–Y017: 2.4
		ms	10	<0.2 (<5 μs for Y0, Y1) ^①	<0.2 (<5 μs for Y0, Y1)

① The 40 and 60 I/O points main units supports 5 μs for Y2.

② This limitation applies only per reference terminal for each group, 4 and 8 outputs for relays and 2 and 4 outputs for transistors. Please observe the terminal assignments for the group identification.

Programming specifications

System specifications	FX3G	FX3GE	FX3GC
Program data			
I/O points (addresses)	256 total (combined local and CC-Link remote I/O)		
Address range	Max. 128 direct addressing and max. 128 remote I/O		
Program memory	32,000 steps EEPROM (internal), exchangeable EEPROM memory cassette		
Cycle period	0.21 μs or 0.42 μs/contact instruction		
Number of instructions	29 sequence instructions, 2 step ladder instructions, 124 applied instructions		
Programming language	Step ladder, instruction list, SFC		
Program execution	Cyclical execution, refreshmode processing		
Program protection	Via password		

System specifications	FX3G	FX3GE	FX3GC
Operands			
Auxiliary relays	7,680 total, with 384 general (M0–M383), 1,152 EEPROM latched (M384–M1535), and 6,144 general/optional latched (M1536–M7679)		
Special auxiliary relays	512 (M8000–M8511)		
State relays	4,096 total, with 1,000 EEPROM latched (S0–S999) and 3,096 general/optional latched (S1000–S4095)		
Timer	320 total, with 206 100 ms (T0–T199 and T250–T255), 46 10 ms (T200–T245), and 68 1 ms (T246–T249 and T256–T319)		
External setpoint entry via potentiometer	2*		
Counter	235 total (16 bit and 32 bit), with 36 general (C0–C15 and C200–C219) and 199 EEPROM latched (C16–C199 and C220–C234)		
High-speed counter	21 total, with 16 1-phase (C235–C250) and 5 2-phase (C251–C255)		
High-speed counter speed	1-phase, 6 points max: 60 kHz/4 points, 10 kHz/2 points 2-phase, 3 points max: 30 kHz/2 points, 5 kHz/1 point		
Real-time clock	Year, month, day, hour, minute, second, weekday		
Data registers	8,000 total, with 128 general (D0–D127), 972 EEPROM latched (D128–D1099), and 6,900 general/optional latched (D1100–D7999)		
Extension registers	24,000 (R0–R23999)		
Extension file registers	24,000 (ER0–R23999) internal/optional memory*		
Index registers	16		
Special data registers	512 (D8000–D8511)		
Pointer	2,048		
Nestings	8		
Interrupt inputs	6		
Constants	16 bits: K: –32,768 to +32,767; H: 0 to FFFF		
	32 bits: K: 2,147,483,648 to +2,147,483,647; H: 0 to FFFF FFFF		

* Not for FX3GC

The MELSEC FX3U series

2
FX base units

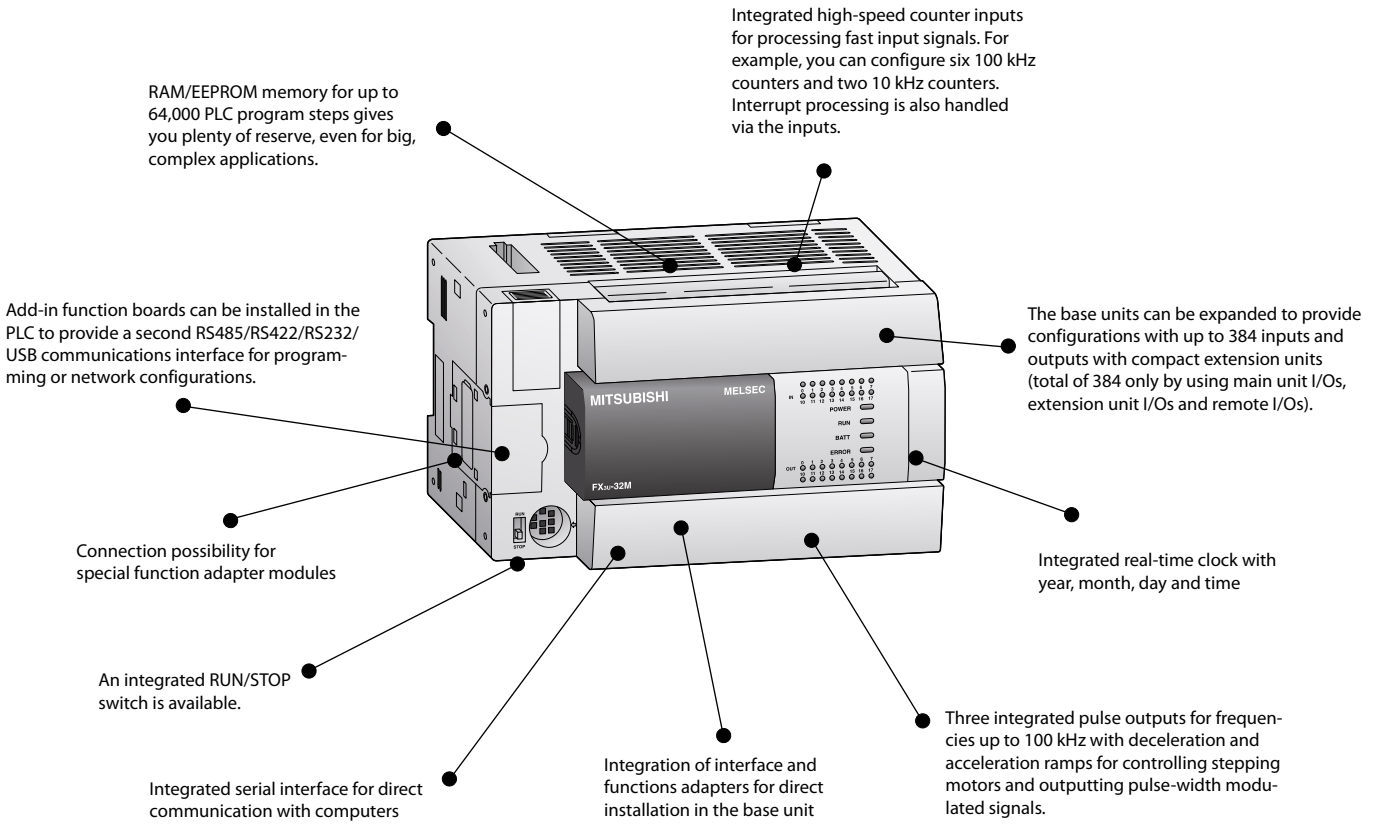

Description of the unit components

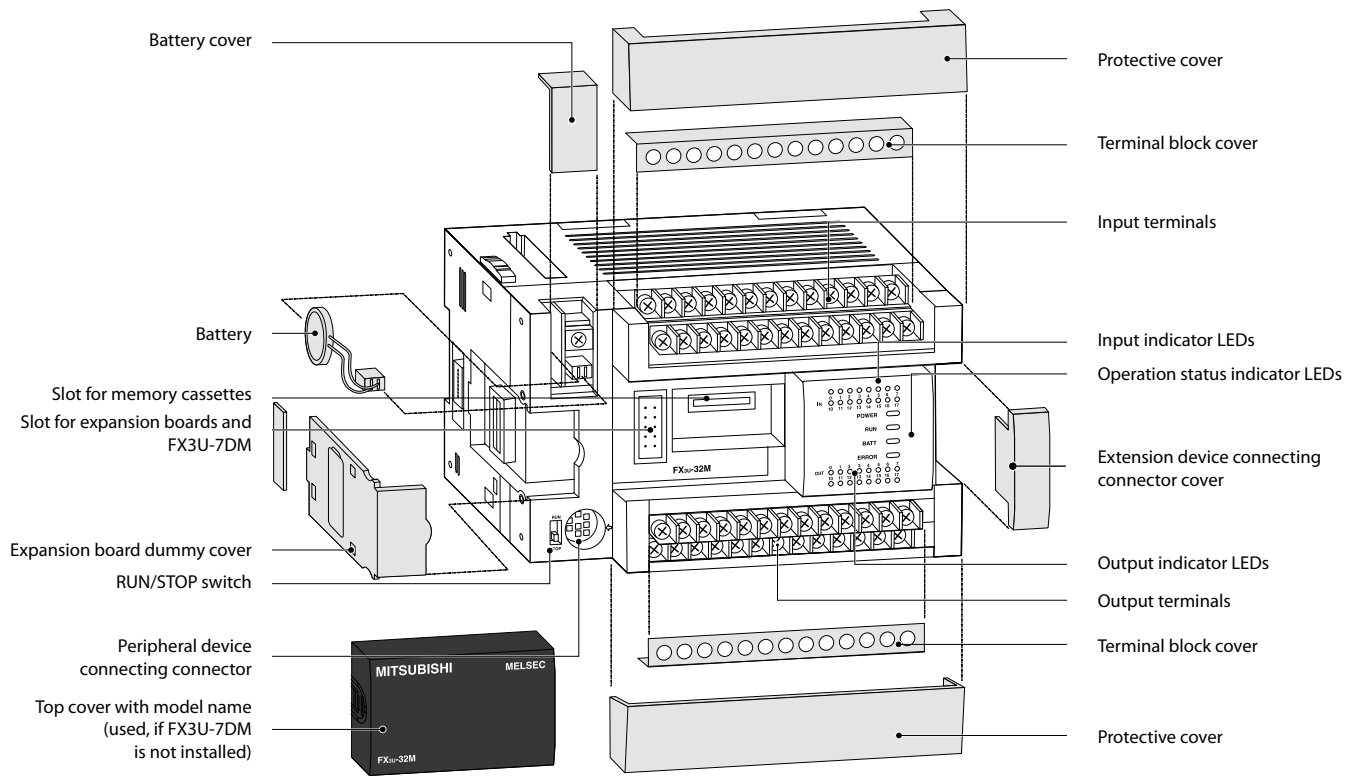

Base units

FX3S FX3G FX3GC FX3GE FX3U FX3UC FX5U FX5UC

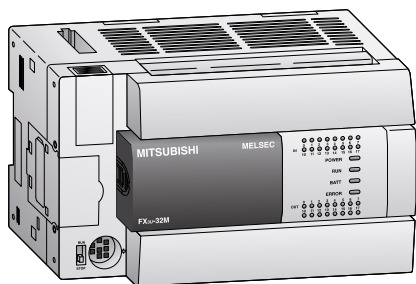

Base units FX3U

The FX3U series base units are available with 16, 32, 48, 64, 80 or 128 input/output points expandable to 384 points.

Models are available for selection with relay or transistor outputs.

- Integrated serial interface for communication between PCs and HMI
- Integrated positioning control
- Exchangeable interface modules for direct mounting into a base unit

- LEDs for indicating the input and output status
- Slot for memory cassettes
- Integrated real-time clock
- Expandable with digital I/O modules, special function modules and ADP modules
- User-friendly programming systems, including IEC 61131-3 (EN 61131-3) compatible programming software, HMIs and hand-held programming units

Base units with 16 I/Os

Specifications	FX3U-16 MR/DS	FX3U-16 MR/ES	FX3U-16 MT/DSS	FX3U-16 MT/ESS
Integrated inputs/outputs	16			
Power supply	24 V DC	100–240 V AC	24 V DC	100–240 V AC
Integrated inputs	8			
Integrated outputs	8			
Output type	Relay		Transistor (source)*	
Power consumption	25 W	30 VA	25 W	30 VA
Weight	kg 0.6			
Dimensions (WxHxD)	mm 130x90x86			
Order information	Art. no. 231498	231486	231503	231492

Base units with 32 I/Os

Specifications	FX3U-32 MR/DS	FX3U-32 MR/ES	FX3U-32 MT/DSS	FX3U-32 MT/ESS
Integrated inputs/outputs	32			
Power supply	24 V DC	100–240 V AC	24 V DC	100–240 V AC
Integrated inputs	16			
Integrated outputs	16			
Output type	Relay		Transistor (source)*	
Power consumption	30 W	35 VA	30 W	35 VA
Weight	kg 0.65			
Dimensions (WxHxD)	mm 150x90x86			
Order information	Art. no. 231499	231487	231504	231493

Note: Further special versions are available on request

* Sink type transistor output units on request.

■ Base units

FX3S FX3G FX3GC FX3GE **FX3U** FX3UC FX5U FX5UC

Base units with 48 I/Os

Specifications	FX3U-48 MR/DS	FX3U-48 MR/ES	FX3U-48 MT/ESS	FX3U-48 MT/DSS
Integrated inputs/outputs	48			
Power supply	24 V DC	100–240 V AC		24 V DC
Integrated inputs	24			
Integrated outputs	24			
Output type	Relay		Transistor (source)*	
Power consumption	35 W	40 VA		35 W
Weight	kg 0.85			
Dimensions (WxHxD)	mm 182x90x86			
Order information	Art. no. 231500	231488	231494	231505

Base units with 64 I/Os

Specifications	FX3U-64 MR/DS	FX3U-64 MR/ES	FX3U-64 MT/ESS	FX3U-64 MT/DSS
Integrated inputs/outputs	64			
Power supply	24 V DC	100–240 V AC		24 V DC
Integrated inputs	32			
Integrated outputs	32			
Output type	Relay		Transistor (source)*	
Power consumption	40 W	45 VA		40 W
Weight	kg 1.0			
Dimensions (WxHxD)	mm 220x90x86			
Order information	Art. no. 231501	231489	231495	231506

Base units with 80–128 I/Os

Specifications	FX3U-80 MR/DS	FX3U-80 MR/ES	FX3U-80 MT/DSS	FX3U-80 MT/ESS	FX3U-128 MR/ES	FX3U-128 MT/ESS
Integrated inputs/outputs	80				128	
Power supply	24 V DC					
Integrated inputs	40				64	
Integrated outputs	40				64	
Output type	Relay		Transistor (source)*		Relay	Transistor (source)*
Power consumption	45 W	50 VA	45 W	50 VA	65 VA	
Weight	kg 1.2				1.8	
Dimensions (WxHxD)	mm 285x90x86				350x90x86	
Order information	Art. no. 231502	231490	231507	231496	231491	231497

Note: Further special versions are available on request

* Sink type transistor output units on request.

Specifications

FX3S FX3G FX3GC FX3GE FX3U FX3UC FX5U FX5UC

Environmental specifications

General specifications	Data
Ambient temperature	0–55 °C (storage temperature: -25–75 °C)
Protection	IP10
Noise durability	1,000 Vpp with noise generator; 1 μs at 30–100 Hz
Dielectric withstand voltage	AC PSU: 1500 V AC, 1 min./DC PSU: 500 V AC, 1 min.
Ambient relative humidity	5–95 % (non-condensing)
Shock resistance	Acc. to IEC 68-2-27: 15 g (3 times each in 3 directions for 11 ms)
Vibration resistance	Acc. to IEC 68-2-6: 1 g (resistance to vibrations from 57–150 Hz for 80 minutes along all 3 axes); 0.5 g for DIN rail mounting
Insulation resistance	5 MΩ, 500 V DC
Ground	Class D: Grounding resistance 100 Ω or less
Fuse rating	From FX3U-16M□ to FX3U-32M□: 3.15 A; from FX3U-48M□ to FX3U-128M□: 5 A
Environment	Avoid environments containing corrosive gases, install in a dust-free location.
Certifications	Please refer to pages 109–111

Electrical specifications

Power supply specifications	DC powered modules (FX3U-□M□/DS/DSS)		AC powered modules (FX3U-□MR/ES)		Output specifications		Relay modules	Transistor modules		
	Power supply	Inrush current at ON	Allowable momentary power failure time	Primary power supply	External power supply (24 V DC)	Switching voltage (max.)	Max. output current	Max. switching current	Response time	Life of contacts (switching times) ③
Power supply	24 V DC (+20 %/-30 %)	—	5 ms	24 V DC	—	V	- per output	- inductive load	ms	3,000,000 at 20 VA; 1,000,000 at 35 VA; 200,000 at 80 VA
Inrush current at ON	—	—	—	—	—	<240 V AC, <30 V DC	A 2	80 VA	10	
Allowable momentary power failure time	—	—	—	—	—		A 8			
Primary power supply	—	—	—	—	—					
External power supply (24 V DC)	—	—	—	—	—					

① or Y0 and Y1 = 0.3 A; all others 0.5 A ② 0.8 for 4 per group and 1.6 for 8 per group

③ Not guaranteed by Mitsubishi Electric.

* This limitation applies only per reference terminal for each group, 4 and 8 outputs for relays and 2 and 4 outputs for transistors. Please observe the terminal assignments for the group identification.

Programming specifications

System specifications	FX3U	System specifications	FX3U
Program data		Operands	
I/O points (addresses)	Max. total 384 (with remote I/O)	Auxiliary relays	7,680 total, with 500 general (M0–M499), 524 optional latched (M500–M1023), and 6,656 latched (M1024–M7679)
Address range	Max. 256 direct addressing and max. 256 network I/Os	Special auxiliary relays	512 (M8000–M8511)
Program memory	64,000 steps RAM (internal), exchangeable FLROM for easy program exchange	State relays	4,096 total, with 1,000 optional latched (S0–S999) and 3,096 latched (S1000–S4095)
Cycle period	0.065 μs/basic instruction	Timer	512 total, with 206 100 ms (T0–T191, T192–T199 and T250–T255), 46 10 ms (T200–T245), and 260 1 ms (T246–T249 and T256–T511)
Number of instructions	29 sequence instructions, 2 step ladder instructions, 218 applied instructions	Counter	235 total (16 bit and 32 bit), with 36 general (C0–C15 and C200–C219) and 199 EEPROM latched (C16–C199 and C220–C234)
Programming language	Ladder, instruction list, SFC Step ladder	High-speed counter	21 total, with 16 1-phase (C235–C250) and 5 2-phase (C251–C255)
Program execution	Cyclical execution, refresh mode processing	High-speed counter speed	1 phase, 8 points max: 100 kHz/6 points 10 kHz/2 points 2 phase, 2 points max: 50 kHz/2 points
Program protection	2 different keywords, max. password length 16 characters	Real-time clock	Year, month, day, hour, minute, second, weekday
		Data registers	8,000 total, with 200 general (D0–D199), 312 optional latched (D200–D511), and 7,488 latched (D512–D7999)
		Extension registers	32,768 (R0–R32767)
		Extension file registers	32,768 (ER0–R32767) optional memory
		Index registers	16
		Special registers	512 (D8000–D8511)
		Pointer	4,096
		Nestings	8
		Interrupt inputs	6
		Constants	16 bits: K: -32,768 to +32,767; H: 0 to FFFF 32 bits: K: 2,147,483,648 to +2,147,483,647; H: 0 to FFFF FFFF

The MELSEC FX3UC series

2

FX base units

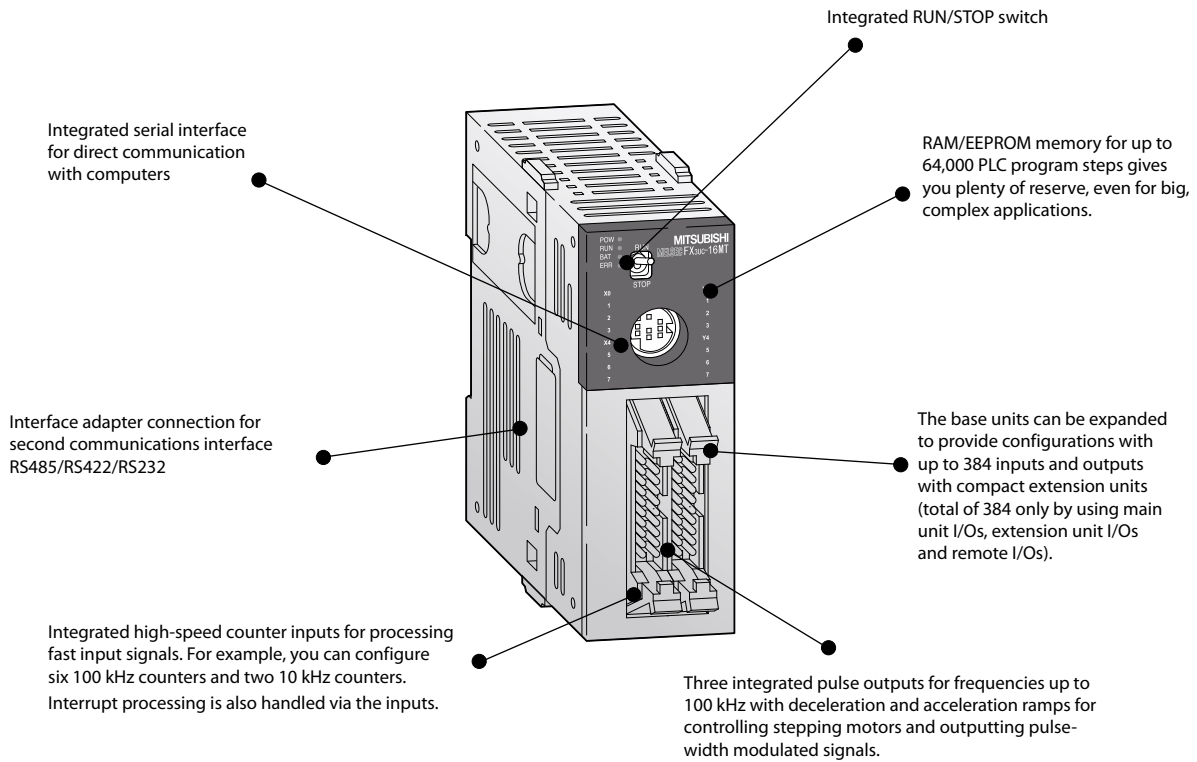

Description of the unit components

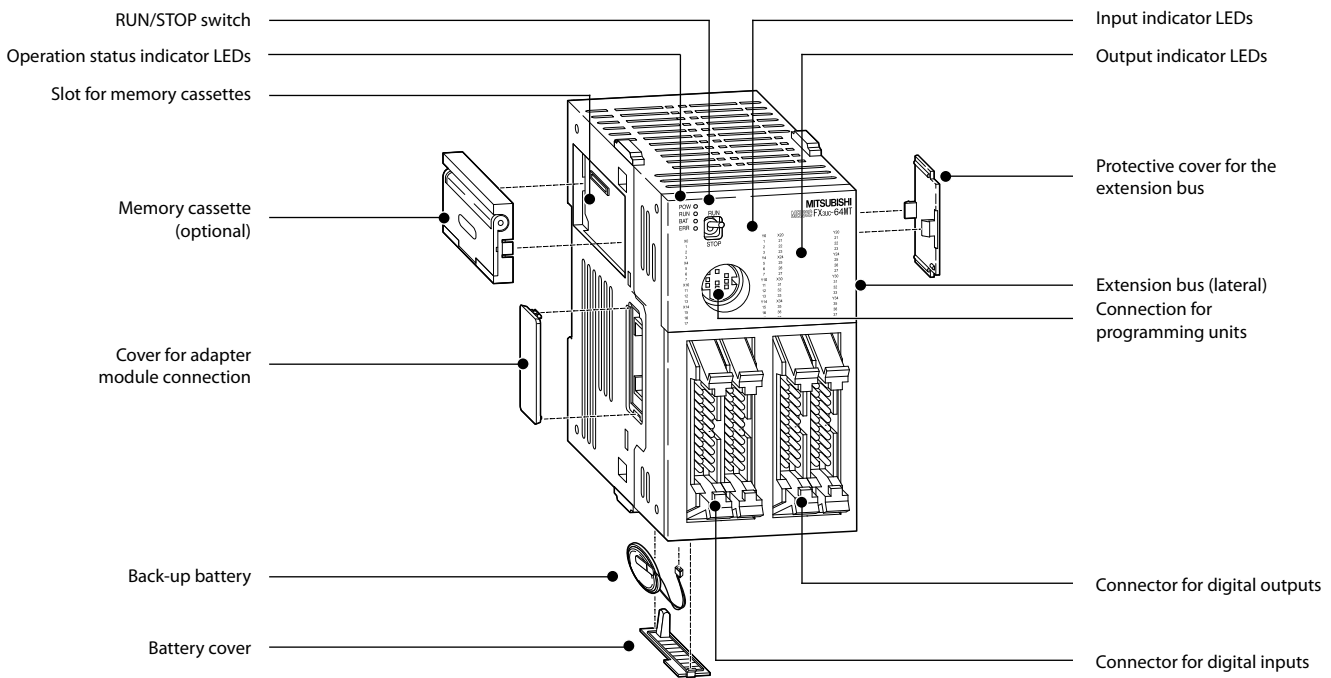

■ Base units

- FX3S FX3G FX3GC FX3GE FX3U FX3UC FX5U FX5UC

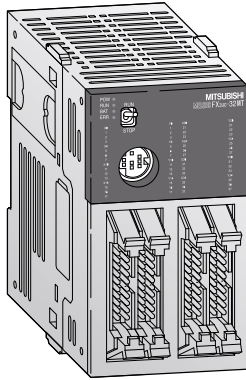

Base units FX3UC

The base units of the FX3UC series are available in versions with 16, 32, 64 or 96 inputs/outputs (expandable to 384 I/Os).

The units are available with transistor outputs only.

- Integrated serial interface for communication between PCs and HMI
- Same instruction set as FX3U
- Integrated positioning control
- Very compact dimensions

- LEDs for indicating the input and output status
- Slot for memory cassette
- Adapter modules and system cabling sets available for units with ribbon cable connectors
- Expandable with digital I/O modules, special function modules and ADP modules
- User-friendly programming systems, including IEC 61131-3 (EN 61131-3) compatible programming software, HMIs and hand-held programming units

Base units with 16–96 I/Os

Specifications	FX3UC-16 MT/DSS	FX3UC-32 MT/DSS	FX3UC-64 MT/DSS	FX3UC-96 MT/DSS
Integrated inputs/outputs	16	32	64	96
Power supply	24 V DC (+20 %, -15 %)			
Integrated inputs	8	16	32	48
Integrated outputs	8	16	32	48
Output type	Transistor (source)*			
Power consumption	W 6	8	11	14
Weight	kg 0.2		0.3	0.35
Dimensions (WxHxD)	mm 34x90x74		59.7x90x74	85.4x90x74
Order information	Art. no. 231508	231509	231510	231511

* Sink type transistor output units on request.

System cabling

Terminal blocks with screw or spring terminals are available for easy wiring of the FX3UC modules with standard ribbon cable connectors.

For detailed information about the terminal blocks, please refer to chapter accessories.

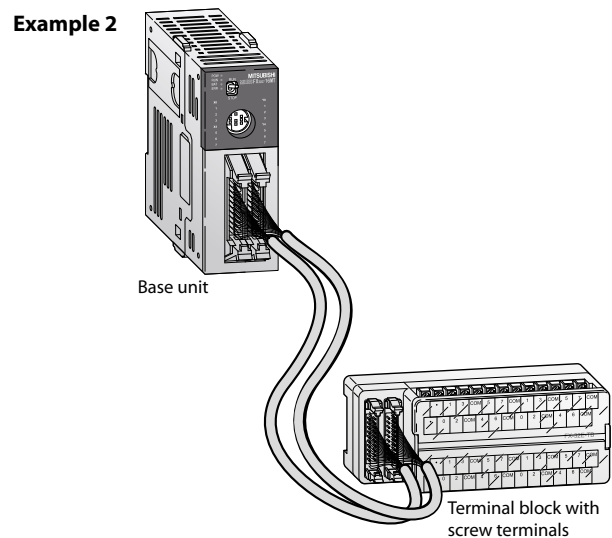
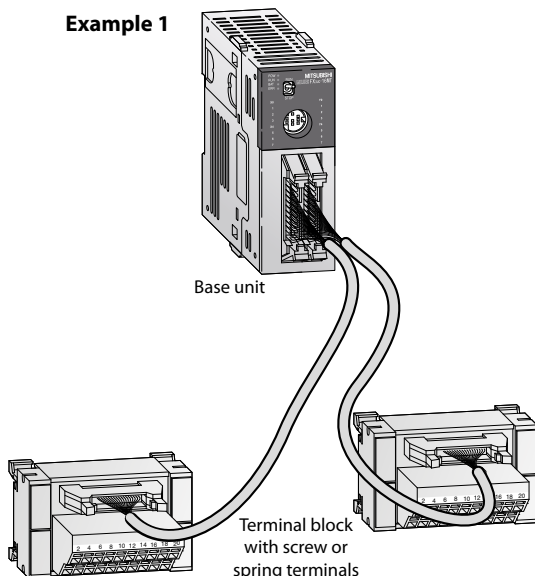

Specifications

FX3S FX3G FX3GC FX3GE FX3U FX3UC FX5U FX5UC

Environmental specifications

General specifications	Data
Ambient temperature	0–55 °C (storage temperature: -25–75 °C)
Protection	IP10
Noise durability	1000 Vpp with noise generator; 1 μs at 30–100 Hz
Dielectric withstand voltage	AC PSU: 1500 V AC, 1 min./DC PSU: 500 V AC, 1 min.
Ambient relative humidity	5–95 % (non-condensing)
Shock resistance	Acc. to IEC 68-2-27: 15 g (3 times each in 3 directions for 11 ms)
Vibration resistance	Acc. to IEC 68-2-6: 1 g (resistance to vibrations from 57–150 Hz for 80 minutes along all 3 axes); 0.5 g for DIN rail mounting
Insulation resistance	500 V DC, 5 MΩ
Ground	Class D: Grounding resistance 100 Ω or less
Environment	Avoid environments containing corrosive gases, install in a dust-free location.
Certifications	Please refer to pages 109–111

Electrical specifications

Power supply specifications	All modules
Power supply	24 V DC (+20 %/-30 %)
Inrush current at ON	—
Allowable momentary power failure time	5 ms
Primary power supply	24 V DC
External power supply (24 V DC)	—

Output specifications	Alle modules
Switching voltage (max.)	V 5–30 V DC
Max. output current	- per output A 0.1/0.3 ^① - per group* A 0.8/1.6
Max. switching current	- inductive load 2.4 W/7.2 W ^②
Response time	ms <0.2 (Y0, Y1 <30 μs)
Life of contacts (switching times) ^③	3,000,000 at 20 VA; 1,000,000 at 35 VA; 200,000 at 80 VA

① or Y0 and Y1 = 0.3 A; all others 0.1 A ② 7.2 W for Y0 to Y3, all other outputs 2.4 W

③ Not guaranteed by Mitsubishi Electric.

* This limitation applies only per reference terminal for each group, 4 and 8 outputs for relays and 2 and 4 outputs for transistors. Please observe the terminal assignments for the group identification.

Programming specifications

System specifications	FX3UC
Program data	
I/O points (addresses)	Max. total 384 (with remote I/O)
Address range	Max. 256 direct addressing and max. 256 network I/Os
Program memory	64,000 steps RAM (internal), exchangeable FLROM for easy program exchange
Cycle period	0.065 μs/basic instruction
Number of instructions	29 sequence instructions, 2 step ladder instructions, 218 applied instructions
Programming language	Ladder, instruction list, SFC Step ladder
Program execution	Cyclical execution, refresh mode processing
Program protection	2 different keywords, max. password length 16 characters

System specifications	FX3UC
Operands	
Auxiliary relays	7,680 total, with 500 general (M0–M499), 524 optional latched (M500–M1023), and 6,656 latched (M1024 - M7679)
Special auxiliary relays	512 (M8000–M8511)
State relays	4,096 total, with 1,000 optional latched (S0–S999) and 3,096 latched (S1000–S4095)
Timer	512 total, with 206 100 ms (T0–T191, T192–T199 and T250–T255), 46 10 ms (T200–T245), and 260 1 ms (T246–T249 and T256–T511)
Counter	235 total (16 bit and 32 bit), with 36 general (C0–C15 and C200–C219) and 199 EEPROM latched (C16–C199 and C220–C234)
High-speed counter	21 total, with 16 1-phase (C235–C250) and 5 2-phase (C251–C255)
High-speed counter speed	1 phase, 8 points max: 100 kHz/6 points 10 kHz/2 points 2 phase, 2 points max: 50 kHz/2 points
Real-time clock	Year, month, day, hour, minute, second, weekday
Data register	8,000 total, with 200 general (D0–D199), 312 optional latched (D200–D511), and 7,488 latched (D512–D7999)
Extension registers	32,768 (R0–R32767)
Extension file register	32,768 (ER0–R32767) optional memory
Index register	16
Special register	512 (D8000–D8511)
Pointer	4,096
Nestings	8
Interrupt inputs	6
Constants	16 bits: K: -32,768 to +32,767; H: 0 to FFFF 32 bits: K: 2,147,483,648 to +2,147,483,647; H: 0 to FFFF FFFF

Powered extension units

FX3S FX3G FX3GC FX3GE FX3U FX3UC FX5U FX5UC

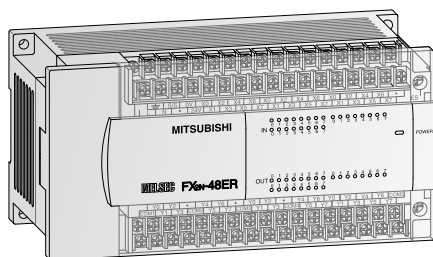

Extension units FX2N

The FX2N series extension units are available with 32 or 48 input/output points. It is possible to choose between relay and transistor output type.

- LEDs for indicating the input and output status
- MELSEC FX3G/FX3GE and FX3U series compatible
- Detachable terminal blocks
- Integrated service power supply with 250 mA or 460 mA

Specifications	FX2N-32 ER-ES/UL	FX2N-32 ET-ESS/UL	FX2N-48 ER-DS	FX2N-48 ER-ES/UL	FX2N-48 ET-DSS	FX2N-48 ET-ESS/UL
Electrical data						
Integrated inputs/outputs	32		48			
Power supply	AC range (+10 %, -15 %)	100–240 V		100–240 V	—	100–240 V
	Frequency at AC	50/60		50/60	—	50/60
	DC range (+20 %, -30 %)	—		24 V	24 V	—
Max. input apparent power	35 VA		30 W	45 VA	30 W	45 VA
Inrush current at ON	100 V AC	40 A < 5 ms		—	40 A < 5 ms	—
	200 V AC	60 A < 5 ms		—	60 A < 5 ms	—
Allowable momentary power failure time	ms		10	5	10	5
External service power supply (24 V DC)	mA		250	—	460	—
Power supply int. bus (5 V DC)	mA		690	—	—	460
Inputs						
Integrated inputs	16		24			
Min. current for logical 1	mA		3.5			
Max. current for logical 0	mA		1.5			
Response time	For all extension units of the MELSEC FX2N series: 10 ms (at time of shipment)					
Outputs						
Integrated outputs	16		24			
Output type	Relay		Transistor (source)		Relay	
Switching voltage (max.)	Generally for relay version: <264 V AC, <30 V DC; for transistor version: 5–30 V DC					
Max. output current	- per output	A	2	0.5	2	0.5
	- per group*	A	8	0.8/1.6 ^②	8	0.8/1.6 ^②
Max. switching power - inductive load	W	80	12	80	12	80
	ms	10	<0.2	10	<0.2	10
Life of contacts (switching times) ^①	For all extension units of the MELSEC FX2N series: 3,000,000 at 20 VA; 1,000,000 at 35 VA; 200,000 at 80 VA (for relay output only)					
Mechanical data						
Weight	kg	0.65		0.85		
Dimensions (WxHxD)	mm	150x90x87		182x90x87		
Order information	Art. no.	65568	65569	66633	65571	66634
						65572

① Not guaranteed by Mitsubishi Electric

② 0.8 for 4 per group and 1.6 for 8 per group

* This limitation applies only per reference terminal for each group. Please observe the terminal assignments for the group identification.

■ Powered extension units

FX3S FX3G FX3GC FX3GE FX3U FX3UC FX5U FX5UC

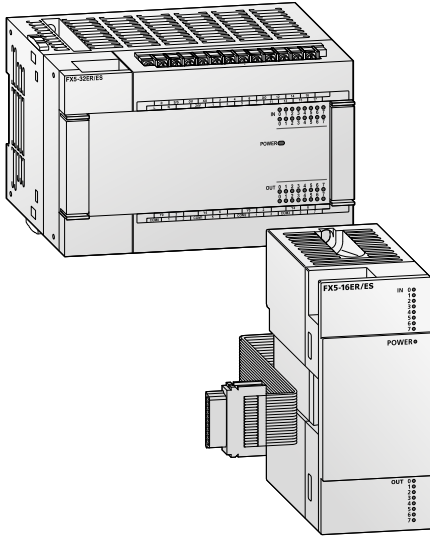

Powered input/output modules FX5

The powered input/output modules of the FX5 series are available with AC or DC power supply. They can be used in a system with a FX5U or FX5UC CPU module. Both relay and transistor output types are available.

- LEDs for indicating the input and output status
- MELSEC FX5U and FX5UC series compatible
- Detachable terminal blocks
- AC powered I/O modules with integrated service power supply with 310 mA

Specifications	FX5-16 ER/ES	FX5-16 ET/ESS	FX5-32 ER/DS	FX5-32 ET/DSS	FX5-32 ER/ES	FX5-32 ET/ESS	
Electrical data							
Integrated inputs/outputs	16		32				
Power supply	AC range (+10 %, -15 %)		—		100–240 V		
	Frequency at AC Hz		—		50/60		
	DC range (+20 %, -30 %)		24 V		—		
Max. input apparent power	W		25				
Inrush current at ON	24 V DC		50 A <0.5 ms		—		
	100 V AC		—		30 A <5 ms		
	200 V AC		—		65 A <5 ms		
Allowable momentary power failure time	ms		5		10 ^②		
External service power supply (24 V DC)	mA		—		310		
Power supply int. bus (5 V DC)	mA		965				
Inputs							
Integrated inputs	8		16				
Input type	Sink/source						
Input signal voltage	24 V DC +20 %, -15 %						
Min. current for logical 1	mA		3				
Max. current for logical 0	mA		1.5				
Response time			Hardware filter delay: ON: 50 μs or less; OFF: 150 μs or less Digital filter setting value: 10 ms (initial value), adjustable from 10 μs to 70 ms				
Outputs							
Integrated outputs	8		16				
Output type	Relay	Transistor (source) ^④	Relay	Transistor (source) ^④	Relay	Transistor (source) ^④	
Switching voltage (max.)	≤30 V DC, ≤240 V AC	5–30 V DC	≤240 V AC, ≤30 V DC	5–30 V DC	≤240 V AC, ≤30 V DC	5–30 V DC	
Max. output current	- per output	A	2	0.5	2	0.5	
	- per group*	A	8	0.8/1.6 ^③	8	0.8/1.6 ^③	
Response time	ms		10	≤0.2	10	≤0.2	
Life of contacts (switching times) ^①	3,000,000 at 20 VA; 1,000,000 at 35 VA; 200,000 at 80 VA		3,000,000 at 20 VA; 1,000,000 at 35 VA; 200,000 at 80 VA		3,000,000 at 20 VA; 1,000,000 at 35 VA; 200,000 at 80 VA		
Mechanical data							
Weight	kg		0.25		0.65		
Dimensions (WxHxD)	mm		40x90x83		150x90x83		
Order information	Art. no.	304652	304654	297439	297441	280506	280508

① Not guaranteed by Mitsubishi Electric

② Adjustable from 10 to 100 ms when the supply voltage is 200 V AC

③ 0.8 A for 4 outputs per group and 1.6 A for 8 outputs per group

④ Sink type transistor output units on request.

* This limitation applies only per reference terminal for each group. Please observe the terminal assignments for the group identification..

Unpowered extension modules

FX3S FX3G FX3GC FX3GE FX3U FX3UC FX5U FX5UC

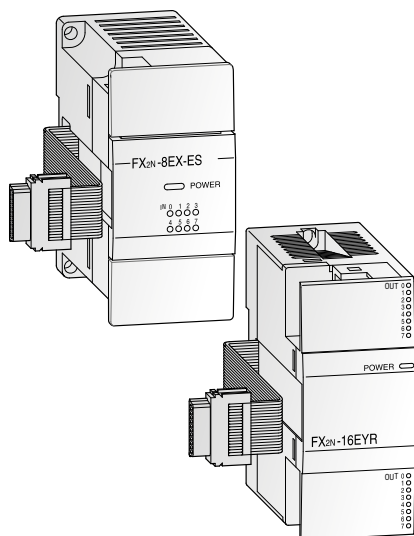

Extension blocks FX2N

The FX2N series modular extension blocks are available with 8 or 16 input/output points. It is possible to choose between relay and transistor output type.

- LEDs for indicating the input and output status
- MELSEC FX3G/FX3GC/FX3GE and FX3U series compatible
- Very compact dimensions
- Vertically terminal blocks with a cable guide to the upper or lower side

Specifications	FX2N-8 ER-ES/UL	FX2N-8 EX-ES/UL	FX2N-8 EYR-ES/UL	FX2N-8 EYT-ESS/UL	FX2N-16 EX-ES/UL	FX2N-16 EYR-ES/UL	FX2N-16 EYT-ESS/UL
Electrical data							
Integrated inputs/outputs	8				16		
Number of occupied I/O points in the PLC	16		8		16		
Power supply	All modular extension blocks are supplied by the base unit.						
Inputs							
Integrated inputs	4		8		16		
Min. current for logical 1	mA 3.5				3.5		
Max. current for logical 0	mA 1.5				1.5		
Response time	For all extension blocks of the MELSEC FX2N series: 10 ms (at time of shipment)						
Outputs							
Integrated outputs	4		8		16		
Output type	Relay		Relay		Transistor		
Switching voltage (max.)	Generally for relay version: <240 V AC, <30 V DC; for transistor version: 5–30 V DC						
Max. output current	- per output A 2		2		0.5		
	- per group ^① A 8		8		0.8		
Max. switching power	- inductive load VA 80		80		12		
Response time	ms 10				<0.2		
Life of contacts (switching times) ^②	For all extension units of the MELSEC FX2N series: 3,000,000 at 20 VA; 1,000,000 at 35 VA; 200,000 at 80 VA (for relay output only)						
Mechanical data							
Weight	kg 0.2				0.3		
Dimensions (WxHxD)	mm 43x90x87				40x90x87		
Order information							
Art. no.	166285	166284	166286	166287	65776	65580	65581

① This limitation applies only per reference terminal for each group. Please observe the terminal assignments for the group identification.

② Not guaranteed by Mitsubishi Electric

Note: To connect these modules to a FX3GC base unit, an adapter FX2N-CNV-IF or a power supply FX3UC-1PS-5V is required.

Unpowered extension modules

FX3S FX3G FX3GC FX3GE FX3U FX3UC FX5U FX5UC

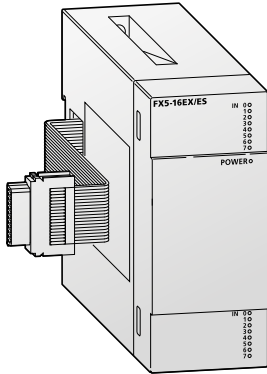

Input/output modules FX5 (terminal block type)

The FX5 series I/O modules with terminal block can be connected to a FX5U CPU module directly. For the connection to a FX5UC CPU module a connector conversion module FX5-CNV-IFC or an extension power supply module FX5-C1PS-5V is required. Modules are available with 8 or 16 inputs/output points and relay or transistor output type.

The FX5-16ET/ES-H and the FX5-16ET-ESS-H are high-speed pulse input/output modules for frequencies up to 200 kpps.

- LEDs for indicating the input and output status
- MELSEC FX5U and FX5UC series compatible
- Photocoupler isolation for input terminals and transistor outputs, mechanical isolation for relay outputs
- Vertically terminal blocks with a cable guide to the upper or lower side

Specifications	High-speed pulse input/output modules		Input modules		Output modules			
	FX5-16ET/ESS-H	FX5-8EX/ES	FX5-16EX/ES	FX5-8EYR/ES	FX5-8EYT/ESS	FX5-16EYR/ES	FX5-16EYT/ESS	
Electrical data								
Integrated inputs/outputs	16	8	16	8		16		
Power supply	5 V DC	Supplied internally	Supplied internally	Supplied internally				
	24 V DC	Supplied from service power supply or external power supply	Supplied from service power supply or external power supply	Supplied internally				
Current consumption	5 V DC	mA 100	75	100	75	100		
	24 V DC	mA 125 (82 ^①)	50	85	75	125		
Inputs								
Integrated inputs	8	8	16					
Input type	Sink/source	Sink/source						
Input signal voltage	24 V DC +20 %, -15 %	24 V DC +20 %, -15 %						
Min. current for logical 1	mA 3.5	3.0						
Max. current for logical 0	mA 1.5	1.5						
Response time	X0 to X5: ON: ≤2.5 μs; OFF: ≤2.5 μs X6, X7: ON: ≤30 μs; OFF: ≤50 μs	ON: ≤50 μs; OFF: ≤150 μs						
Outputs								
Integrated outputs	8			8		16		
Output type	Transistor (source) ^④			Relay	Transistor (source) ^④	Relay	Transistor (source) ^④	
Switching voltage (max.)	5–30 V DC			≤240 V AC, ≤30 V DC	5–30 V DC	≤240 V AC, ≤30 V DC	5–30 V DC	
Max. output current	- per output	A 0.5		2	0.5	2	0.5	
	- per group*	A 1.6 ^②		8	0.8 ^③	8	1.6 ^②	
Response time	ms	Y0, Y1, Y4, Y5: ≤2.5 μs Y2, Y3, Y6, Y7: ≤0.2 ms		Approx. 10	≤0.2	Approx. 10	≤0.2	
Mechanical data								
Weight	kg	0.25	0.25	0.2	0.25			
Dimensions (WxHxD)	mm	40x90x83	40x90x83	40x90x83				
Order information	Art. no.	297443	280498	280505	280499	280501	280502	280504

① Current consumption when external power supply is used for the input circuit.

② 1.6 A for 8 outputs per group

③ 0.8 A for 4 outputs per group

④ Sink type transistor output units on request.

* This limitation applies only per reference terminal for each group. Please observe the terminal assignments for the group identification.

Unpowered extension modules

FX3S FX3G FX3GC FX3GE FX3U FX3UC FX5U FX5UC

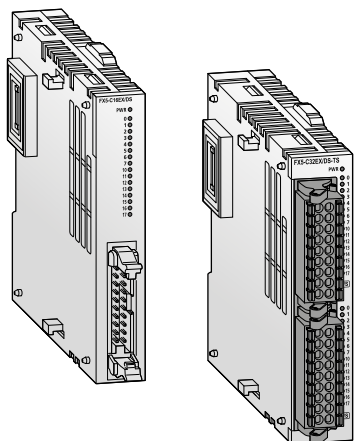

Input/output modules FX5 (connector type)

The connector type FX5 series I/O modules can be directly connected to an FX5UC CPU module. For the connection to an FX5U CPU module a connector conversion module FX5-CNV-IF is required. Modules are available with 16 or 32 inputs/output points.

- Very compact dimensions
- LEDs for indicating the input and output status
- MELSEC FX5U and FX5UC series compatible
- Photocoupler isolation for input terminals and transistor outputs
- Terminal modules for the conversion of connector-type I/O terminals into terminal blocks are available
- Spring clamp type I/O available

Specifications	Input/output modules		Input modules			Output modules				
	FX5-C32ET/DSS	FX5-C32ET/DSS-TS*	FX5-C16EX/DS	FX5-C32EX/DS	FX5-C32EX/DS-TS*	FX5-C16EYR/D-TS*	FX5-C16EYT/DSS	FX5-C32EYT/DSS	FX5-C32EYT/DSS-TS*	
Electrical data										
Integrated inputs/outputs	32		16	32		16		32		
Power supply	5 V DC	Supplied internally		Supplied internally			Supplied internally			
	24 V DC	Input connector: Supplied from service power supply or external power supply Output connector: Supplied internally		Supplied from service power supply or external power supply			Supplied internally			
Current consumption	5 V DC	mA	120		100		120	100	120	
	24 V DC	mA	Input connector: 65 Output connector: 100 ^①	65	130		100		200	
Inputs										
Integrated inputs	16		16	32						
Input type	Sink/source		Sink/source							
Input signal voltage	24 V DC +20 %, -15 %		24 V DC +20 %, -15 %							
Min. current for logical 1	mA	3.0	3.0							
Max. current for logical 0	mA	1.5	1.5							
Response time	ON: ≤50 μs; OFF: ≤150 μs		ON: ≤50 μs; OFF: ≤150 μs							
Outputs										
Integrated outputs	16					16		32		
Output type	Transistor (source) ^③					Relay	Transistor (source) ^③			
Switching voltage (max.)	5–30 V DC					≤240 V AC, ≤30 V DC	5–30 V DC			
Max. output current	- per output	A	0.1			2 A	0.1			
	- per group ^④	A	0.8 ^②			4	0.8 ^②			
Response time	ms	≤0.2				Approx. 10	≤0.2			
Mechanical data										
Weight	kg	0.15	0.1	0.15		0.2	0.1	0.15		
Dimensions (WxHxD)	mm	20.1x90x87	20.1x90x93.7	14.6x90x87	20.1x90x87	20.1x90x93.7	30.7x90x93.7	14.6x90x87	20.1x90x87	20.1x90x93.7
Order information	Art. no.	283534	315636	294583	283532	315552	413833	294585	283556	315554

① Current consumption when external power supply is used for the input circuit.

② 0.8 A per COM /+V terminal

③ Sink type transistor output units on request.

④ This limitation applies only per reference terminal for each group. Please observe the terminal assignments for the group identification.

* When connecting to FX5U CPU module, FX5-CNV-IF is required.

Unpowered extension modules

FX3S FX3G FX3GC FX3GE FX3U FX3UC FX5U FX5UC

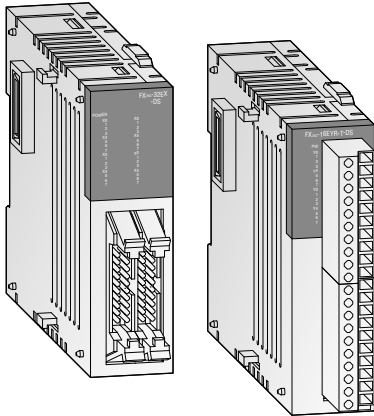

The modular extension units of the FX2NC series can be used in combination with FX3GC or FX3UC series base units. They are available with 16 or 32 input/output points. For modules with 16 outputs it is possible to choose between relay and transistor output type.

- Very compact dimensions
- LEDs for indicating the input and output status
- Removable terminal blocks for FX2NC-16EYR-T-DS and FX2NC-16EX-T-DS (interchangeable against optional spring terminal blocks)
- Adapter modules and system cabling sets are optionally available for units with ribbon cable connectors (transistor output types)

Specifications	FX2NC-16 EX-T-DS	FX2NC-16 EYR-T-DS	FX2NC-16 EX-DS	FX2NC-16 EYT-DSS	FX2NC-32 EX-DS	FX2NC-32 EYT-DSS
Electrical data						
Integrated inputs/outputs	16			32		
Power supply	All modular extension blocks are supplied by the base unit.					
Inputs						
Integrated inputs	16	—	16	—	32	—
Input current X0→X7 / X10→∞	7/5	—	7/5	—	7/5	—
Min. current for logical 1 X0→X7/X10→∞	4.5/3.5	—	4.5/3.5	—	4.5/3.5	—
Max. current for logical 0	1.5	—	1.5	—	1.5	—
Isolation	Photocoupler isolation between input terminals and PC power for all base units					
Response time	For all extension units of the MELSEC FX2NC series: 10 ms (at time of shipment), partly adjustable between 0 and 60 ms in 1 ms steps (REF, FNC51 = 0–60 ms)					
Outputs						
Integrated outputs	—	16	—	16	—	32
Output type	—	Relay	—	Transistor	—	Transistor
Switching voltage (max.)	Generally for relay version: <240 V AC, <30 V DC; for transistor version: 5–30 V DC					
Max. output current	—	2	—	0.1/0.3 ^①	—	0.1/0.3 ^①
- per output	A	—	—	—	—	—
- per group*	A	4/8	—	0.8	—	0.8
Max. switching power	—	80	—	2.4/7.2 ^②	—	2.4/7.2 ^②
- inductive load	VA	—	—	—	—	—
- lamp load	W	100	—	0.3/0.9 ^③	—	0.3/0.9 ^③
Response time	ms	10	—	<0.2	—	<0.2
Life of contacts (switching times)	—	like base unit	—	—	—	—
Mechanical data						
Connection type	Removable screw terminal blocks			Ribbon cable connector		
Weight	kg	0.2	—	0.15	0.2	—
Dimensions (WxHxD)	mm	20.2x90x89		14.6x90x87		26.2x90x87
Order information						
Art. no.	128152	128153	104503	104504	104505	104506

^① 0.3 A for Y0 to Y1; 0.1 A all others ^② 7.2 W for Y0 to Y3; 2.4 W all others ^③ 0.9 W for Y0 to Y3; 0.3 W all others

*This limitation applies only per reference terminal for each group. Please observe the terminal assignments for the group identification.

Note: These modules can be combined with PLC base units of the FX3GC or FX3UC series!

Analog input modules

FX3S FX3G FX3GC FX3GE FX3U FX3UC FX5U FX5UC

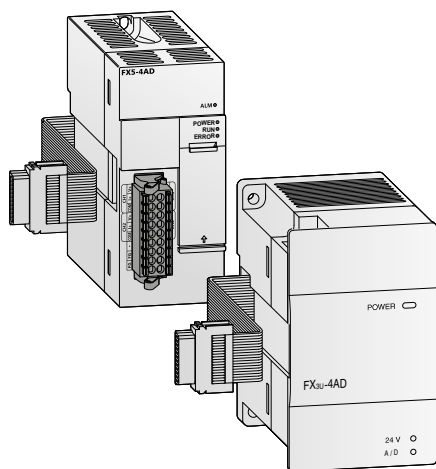

The analog input modules provide the user with 2 to 8 analog inputs.

The module converts analog process signals into digital values which are further processed by the base unit.

The actual values or mean values over several measurements may be output.

The FX5-8AD supports the logging function for up to 10,000 values per channel and the offset/gain adjustment via the programming software.

Specifications	FX2N-2AD	FX3U-4AD	FX3UC-4AD	FX2N-8AD	FX5-4AD	FX5-8AD
Applicable for	Base units FX3G/FX3GC/ FX3GE/FX3U/ FX3UC	Base units FX3G/FX3GC/ FX3GE/ FX3U/FX3UC/ FX5U/FX5UC	Base units FX3GC/FX3UC	Base units FX3G/FX3GC/ FX3GE/FX3U/ FX3UC	Base units FX5U/FX5UC	
Analog channels	Inputs	2	4	8	4	8
	Outputs	—				
Analog input range	0–10 V DC/ 0–5 V DC/ 0/4–20 mA	–10–10 V DC/–20–20 mA/4–20 mA			–10–10 V DC/ –20–20 mA/ 4–20 mA User range setting	–10–10 V DC/ –20–20 mA/ Temperature detector (K, J, T, B, R, S, Pt100, Ni100) ②
Resolution	Voltage	2.5 mV, 1.25 mV/ 4 µA (12 bit)	0.32 mV (16 bit + sign)		0.63 mV (14 bit + sign)	0.3125 mV
	Current	—	1.25 µA (15 bit + sign)		2.5 µA (13 bit + sign)	0.625 µA (16 bit + sign)
Fullscale overall accuracy	±1 %	±0.3–1 % ①		±0.3–0.5 % ①	±0.1–0.3 % ①	±0.3–±0.5 %
Power supply	5 V DC	20 mA (from base unit)	110 mA (from base unit)	100 mA (from base unit)	50 mA (from base unit)	40 mA (from base unit)
	24 V DC	50 mA (from base unit)	90 mA	80 mA	—	100 mA (from base unit)
Related I/O points	8					
Weight	kg	0.3	0.2	0.13	0.4	0.2
Dimensions (WxHxD)	mm	43x90x87	55x90x87	20.2x90x79	75x105x75	40x90x83
Order information	Art. no.	102869	169508	210090	129195	334430
						312297

① Dependent on the ambient temperature

② Please refer to manuals for further details of specification of temperature detectors.

Notes: The FX2N-8AD can be configured to accept standard analog inputs as well as selected temperature inputs such as K, T or J type thermocouples. To connect these modules to a FX3UC or FX3GC base unit, an adapter FX2N-CNV-IF or a power supply FX3UC-1PS-5V is required. For the connection of a FX3U-4AD to a FX5U/FX5UC base unit, a bus conversion module FX5-CNV-BUSC resp. FX5-CNV-BUS is required.

Analog output modules

FX3S FX3G FX3GC FX3GE FX3U FX3UC FX5U FX5UC

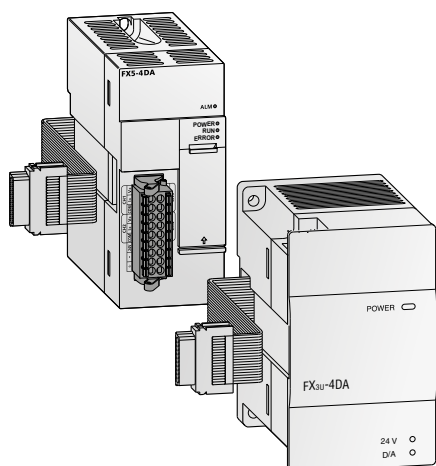

The analog output modules provide the user with 2 to 4 analog outputs. The modules convert digital values from the FX3G/FX3GC/FX3GE/

FX3U/FX3UC controller to the analog signals required by the process. The module can output both current and voltage signals.

Specifications	FX2N-2DA	FX3U-4DA	FX5U-4DA
Applicable for	Base units FX3G/FX3GC/FX3GE/ FX3U/FX3UC	Base units FX3G/FX3GC/FX3GE/ FX3U/FX3UC/FX5U/FX5UC	Base units FX5U/FX5UC
Analog channels	Inputs	—	
	Outputs	2	4
Analog output range	0–10 V DC/0–5 V DC/4–20 mA	–10–10 V DC/0–20 mA/4–20 mA	–10–10 V DC/0–20 mA/4–20 mA User range setting
Resolution	Voltage	2.5 mV (12 bit)	0.32 mV (16 bit + sign)
	Current	4 µA (12 bit)	0.63 µA (15 bit)
Fullscale overall accuracy	±1 %	±0.3–0.5 %*	±0.1–0.3 %*
Power supply	5 V DC	30 mA (from base unit)	—
	24 V DC	85 mA (from base unit)	160 mA
Related I/O points	8		
Weight	kg	0.3	0.2
Dimensions (WxHxD)	mm	43x90x87	55x90x87
Order information	Art. no.	102868	169509
			325715

* Dependent on the ambient temperature

Notes: To connect these modules to a FX3UC or FX3GC base unit, an adapter FX2N-CNV-IF or a power supply FX3UC-1PS-5V is required. For the connection of a FX3U-4DA to a FX5U/FX5UC base unit, a bus conversion module FX5-CNV-BUSC resp. FX5-CNV-BUS is required.

■ Combined analog I/O module

- FX3S FX3G FX3GC FX3GE FX3U FX3UC FX5U FX5UC

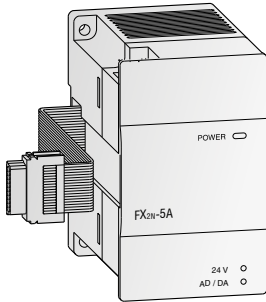

The analog input/output module provides the user with 4 analog inputs and 1 analog output. It serves for conversion of analog process signals into digital values, and vice versa.

For the analog inputs it can be selected between current or voltage input signal.

Specifications		FX2N-5A
Analog channels	Inputs	4
	Outputs	1
Input (resolution)	Voltage	-10–10 V (15 bit + sign), -100–100 mV (11 bit + sign)
	Current	-20–20 mA (14 bit + sign), 0/4–20 mA (14 bit)
Output (resolution)	Voltage	-10–10 V (12 bit)
	Current	0/4–20 mA (10 bit)
Fullscale overall accuracy		±0.3–1 %*
Power supply	5 V DC	70 mA (from base unit)
	24 V DC	90 mA
Related I/O points		8
Weight	kg	0.3
Dimensions (WxHxD)	mm	55x90x87
Order information		Art. no. 153740

Note: To connect the module to a FX3UC or FX3GC base unit, an adapter FX2N-CNV-IF or a power supply FX3UC-1PS-5V is required.

Analog temperature input adapters

FX3S
 FX3G
 FX3GC
 FX3GE
 FX3U
 FX3UC
 FX5U
 FX5UC

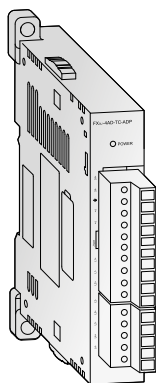

FX3U-4AD-TC-ADP

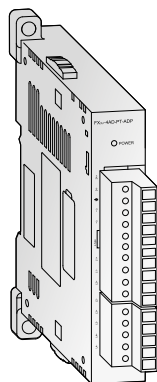

FX3U-4AD-PT-ADP

The analog input adapters for thermocouples are used for processing temperatures. They have 4 independent inputs for detecting signals from thermocouples of various types.

The FX3U/FX5U-4AD-PT-ADP, FX3U-4AD-PTW-ADP and FX3U-4AD-PNK-ADP analog input adapters enable the connection of up to four resistance thermometers to the PLC system.

Specifications	FX3U-4AD-TC-ADP	FX3U-4AD-PT-ADP	FX3U-4AD-PTW-ADP	FX3U-4AD-PNK-ADP	FX5-4AD-PT-ADP	FX5-4AD-TC-ADP
Applicable for	Base units FX3S, FX3G, FX3GC, FX3GE, FX3U, FX3UC				Base units FX5U, FX5UC	
Analog inputs	4 (thermocouples, J or K type)			4 (Pt1000 or Ni1000)	4	
Compensated temperature range °C	-100–600 (J)/ -100–1000 (K)	-50–250	-100–600	-50–250 (Pt1000)/ -40–110 (Ni1000)	-200–850 (Pt100)/ -60–250 (Ni100)	-40–750 (J)/ -200–1200 (K)/ 0–1600 (R, S)
Digital outputs	-1000–6000 (J)/ -1000–10000 (K)	-500–2500	-1000–6000	-500–2500 (Pt1000)/ -400–1100 (Ni1000)	-2000–8500 (Pt100)/ -600–2500 (Ni100)	-400–7500 (J)/ -2000–12000 (K)/ 0–16000 (R, S)
Resolution °C	0.3 (J)/0.4 (K)	0.1	0.2–0.3	0.1		0.1 (K, J, T), 0.1–0.3 (B, R, S)
Fullscale overall accuracy	±0.5 % (fullscale)	±0.5–1.0 % (fullscale)*			±0.4–2.4 °C (fullscale)* ±2.8–7.2 °C (fullscale)*	
Power supply	5 V DC 24 V DC	15 mA (from base unit) 45 mA 50 mA			10 mA 20 mA	
Related I/O points	0					
Weight kg	0.1					
Dimensions (WxHxD) mm	17.6x90(106)x89.5				17.6x90(106)x74(89.1)	
Order information	Art. no.	165273	165272	214173	214172	304298 304299

* Dependent on the ambient temperature

Notes: When connecting the FX3 analog adapters to a FX3G, FX3S or FX3U base unit, a communications adapter is required. A direct connection without adapter is possible if these modules are connected to a FX3GC, FX3GE or FX3UC base unit.

Analog I/O adapters

FX3S
 FX3G
 FX3GC
 FX3GE
 FX3U
 FX3UC
 FX5U
 FX5UC

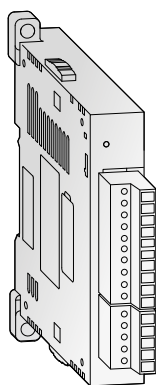

FX3U-4AD-ADP

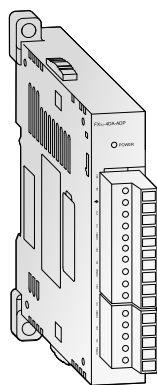

FX3U-4DA-ADP

The analog input adapter FX3U-4AD-ADP is mounted on the left side of the base unit and extends a controller of the FX3 series with 4 analog inputs.

The analog output adapter FX3U-4DA-ADP is mounted on the left side of a FX3 series base unit and provides four analog outputs.

The analog input/output module FX3U-3A-ADP provides the user with two analog inputs and one analog output.

Specifications	FX3U-4AD-ADP	FX3U-4DA-ADP	FX3U-3A-ADP
Analog channels	Inputs: 4 Outputs: —	— 4	2 1
Analog range	0–10 V DC, 4–20 mA		
Resolution	2.5 mV/10 µA (12 bit/11 bit)		2.5 mV/4 µA (12 bit)
Overall accuracy	±0.5 % */±1 %		±0.5–1 %*
Power supply	5 V DC 24 V DC	15 mA (from base unit) 40 mA	20 mA (from base unit) 90 mA
Related I/O points	0		
Weight kg	0.1		
Dimensions (WxHxD) mm	17.6x90(106)x89.5		17.6x90x89.5
Order information	Art. no.	165241	165271 221549

* Dependent on the ambient temperature and signal quality

Notes: When connecting the analog adapters to a FX3G, FX3S or FX3U base unit, a communications adapter is required. A direct connection without adapter is possible if these modules are connected to a FX3GC, FX3GE or FX3UC base unit.

■ Analog I/O adapters

- FX3S FX3G FX3GC FX3GE FX3U FX3UC FX5U FX5UC

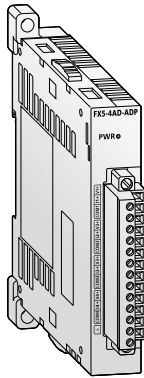

FX5-4AD-ADP

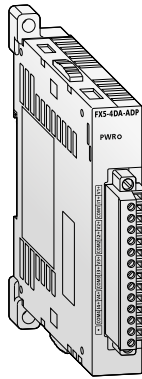

FX5-4DA-ADP

Up to four analog expansion adapters can be mounted on the left side of a FX5U CPU module or FX5UC CPU module.

A FX5-4AD-ADP provides four analog inputs and a FX5-4DA-ADP provides four analog outputs.

Specifications	FX5-4AD-ADP	FX5-4DA-ADP
Analog channels	Inputs	4
	Outputs	—
Analog range	-10–10 V DC, -20–20 mA	-10–10 V DC, 0–20 mA
Resolution	312.5 μ V/1.125 μ A (14 bit)	250 μ V/1 μ A (14 bit)
Overall accuracy	± 0.1 %*/ ± 0.3 %	± 0.1 %*/ ± 0.2 %
Power supply	5 V DC	10 mA (from base unit)
	24 V DC	20 mA (from base unit)
Related I/O points	0	160 mA (external power supply)
Weight	kg	0.1
Dimensions (WxHxD)	mm	17.6x90(106)x89.1
Order information	Art. no.	283559
		283560

* Dependent on the ambient temperature and signal quality

■ Temperature control modules

- FX3S FX3G FX3GC FX3GE FX3U FX3UC FX5U FX5UC

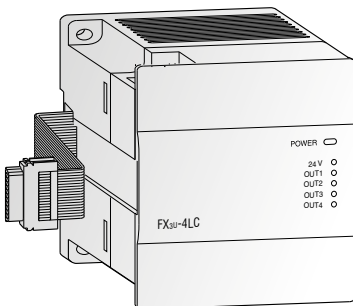

The temperature control module FX3U-4LC is equipped with four temperature input points and four transistor (open collector) output points. It is used to read temperature signals from thermocouples and Pt100 sensors, and performs PID output control.

The proportional band, the integral time and the derivative time can be easily set by auto tuning.

The channels are isolated against each other. Self-diagnosis functions are provided, and the disconnection of heaters can be detected by current detection (CT).

The temperature control module FX5-4LC supports parameter transfer/automatic refreshing. The spring clamp terminal enables compact size and enhances vibration resistance.

Specifications	FX3U-4LC	FX5-4LC
Applicable for	Base units FX3G, FX3GC, FX3GE, FX3U, FX3UC, FX5U, FX5UC	Base units FX5U, FX5UC
Analog inputs	4 (Thermocouple and Pt100 sensors)	4 (Thermocouple, Pt100 and Pt1000 sensors)
Compensated temperature range	$^{\circ}$ C	-200–2300
Digital outputs	4 NPN transistor open collector output points	
Resolution	$^{\circ}$ C	0.1 or 1
Fullscale overall accuracy	± 0.3 – 0.7 % (fullscale, dependent on the ambient temperature)	0.1 $^{\circ}$ C, 1.0 $^{\circ}$ C, 0.5 μ V or 5.0 μ V Varies depending on input range of used sensors
Power supply	5 V DC	160 mA (from base unit)
	24 V DC	50 mA
Related I/O points	8	25 mA
Dimensions (WxHxD)	mm	90x90x86
		60x90x83
Order information	Art. no.	232806
		312298

Notes: To connect a FX3U-4LC to a FX3UC or FX3GC base unit, an adapter FX2N-CNV-IF or a power supply FX3UC-1PS-5V is required. For the connection of a FX5U-4LC to a FX5UC base unit, a FX5-CNV-IF resp. FX5-C1PS-5V is required.

Data logger module

- FX3S FX3G FX3GC FX3GE FX3U FX3UC FX5U FX5UC

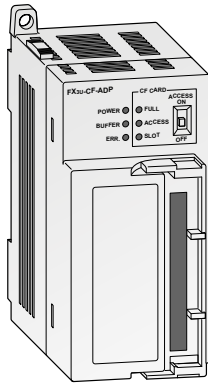

The FX3U-CF-ADP is a general purpose data logging adapter. The difference to other available logging units is that the PLC main unit controls the data logging based on user requirements, e.g. periodical or even based. For tracing a timestamp is automatically added to all data storages, that eases alarm and other time critical logging.

Another usage is the storage of bigger recipe data. A CompactFlash memory card up to 2 GB can be used. Six applied instructions allow all kinds of data writing, manipulation or reading, making this adapter the optimum solution towards customer requirements.

Specifications	FX3U-CF-ADP	
Data access method	Controlled by the main unit, no polling from the logging unit possible.	
Connectable units	A maximum of one FX3U-CF-ADP can be connected per PLC.	
Time stamp function	The real time clock data of the base unit is used.	
Recommended storage media	CompactFlash memory card (GT05-MEM-256MC, -512MC, -1GC, -2GC)	
Max. file size	512 MB	
File format	CSV	
Max. numbers of files	63 (Plus one FIFO file.)	
FIFO function	One pattern (The file name gets automatically generated.)	
Power supply	24 V DC	130 mA
Related I/O points	kg	0
Dimensions (WxHxD)	mm	45x90x89.5
Order information	Art. no.	230104

High-speed counter modules

- FX3S FX3G FX3GC FX3GE FX3U FX3UC FX5U FX5UC

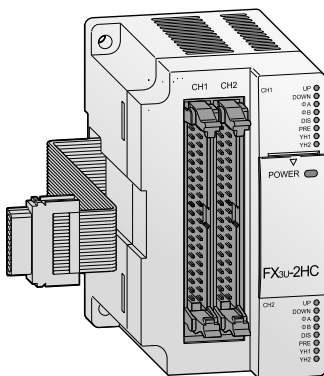

In addition to the internal high-speed MELSEC FX counters, the high-speed counter modules FX2N-1HC, FX2NC-1HC and FX3U-2HC provide the user with an external counter. It counts 1- or 2-phase pulses up to a frequency of 200 kHz. The counting range covers either 16 or 32 bit.

The two integrated transistor outputs can be switched independently of one another by means of internal comparison functions. Hence, simple positioning tasks can also be realized economically. In addition, the modules can be used as a ring counter.

Specifications	FX2N-1HC	FX2NC-1HC*	FX3U-2HC
Applicable for	Base units FX3U/FX3UC		Base units FX3U/FX3UC/FX5U/FX5UC
Counter inputs	2 (1 phase) or 1 (2 phase)		
Max. counting frequency	kHz	50	200/100/50
Signal level	5, 12, 24 V DC/7 mA		5, 12, 24 V DC
Input format	bit	16, 32	—
Type of counter	Up/down counter, ring counter		
Counting range	16 bit	0–65535	
	32 bit	–2147483648–2147483647	
Output type	2 x transistor (5–24 V DC; 0.5 A)		
Power supply	5 V DC	90 mA (from base unit)	24 mA (from base unit)
	24 V DC	—	
Related I/O points	8		
Weight	kg	0.3	0.13
			0.08
Dimensions (WxHxD)	mm	55x90x87	20.2x90x89
			55x90x87
Order information	Art. no.	65584	217916
			232805

* The FX2NC 1HC can only be connected to a FX3UC base unit.
 Note: For the connection of a FX3U-2HC to a FX5U/FX5UC base unit, a bus conversion module FX5-CNV-BUSC resp. FX5-CNV-BUS is required.

High-speed counter adapters

FX3S FX3G FX3GC FX3GE **FX3U** FX3UC FX5U FX5UC

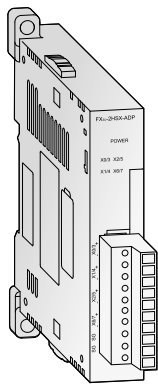

FX3U-4HSX-ADP

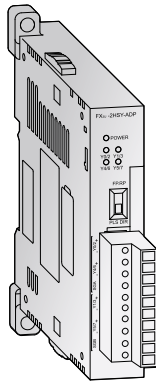

FX3U-2HSY-ADP

These adapter modules allow direct processing of positioning application data.

The FX3U-4HSX-ADP provide high-speed counter inputs up to 200 kHz while the FX3U-2HSY-ADP delivers 2 channels of pulse train outputs up to 200 kHz.

Specifications	FX3U-4HSX-ADP	FX3U-2HSY-ADP
Maximum connectivity	2	
Counter	Inputs	—
	Outputs	2
Max. counting frequency	Inputs kHz	—
	Outputs kHz	200
Input format	Differential line receiver (AM26C32 is suitable) Photocoupler isolation on inputs	—
Output format	—	Differential line driver (AM26C31 is suitable) Normal rotation pulse train, reverse pulse train or pulse train + direction signal
Maximum cable length	m	10
Input potential	5 V DC	
Output load	—	
Power supply	5 V DC	30 mA (from base unit)
	24 V DC	30 mA (from base unit)
Related I/O points	0	
Weight	kg	0.08
Dimensions (WxHxD)	mm	17.6x90(106)x89.5
Order information	Art. no.	165274
		165275

Note: The adapters FX3U-□-ADP can only be used with the FX3U and they require a function extension board.

Single-axis positioning modules

FX3S FX3G FX3GC FX3GE **FX3U** **FX3UC** **FX5U** **FX5UC**

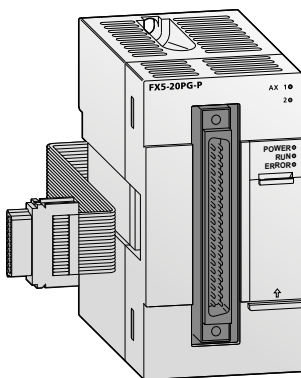

The positioning modules FX3U-1PG, FX2N-10PG and FX5-20PG-P/D are extremely efficient positioning modules for controlling either step drives or servo drives (by external regulator) with a pulse chain. The FX5-20PG-D is a differential driver type with a maximum output pulse of 5 M pulse/s.

They are very suitable for achieving accurate positioning in combination with the MELSEC FX series.

The configuration and allocation of the position data are carried out directly via the PLC program. A very wide range of manual and automatic functions are available to the user.

Specifications	FX3U-1PG	FX2N-10PG	FX5-20PG-D	FX5-20PG-P
Applicable for	Base units FX3U/FX3UC/ FX5U/FX5UC	Base units FX3U/FX3UC	Base units FX5U/FX5UC	
Accessible axes	1		2	
Output frequency	Pulses/s	10–200 000	1–1 000 000	5 000 000
Signal level for digital inputs	24 V DC/40 mA	5 V DC/100 mA; 24 V DC/70 mA	5 V DC; 24 V DC	24 V DC/5 mA
Power supply	5 V DC	150 mA (from base unit)	120 mA (from base unit)	—
	24 V DC	—	—	165 mA (external power supply)
Related I/O points	8			
Weight	kg	0.3	0.2	—
Dimensions (WxHxD)	mm	43x90x87	50x90x83	
Order information	Art. no.	259298	140113	409825
		—	—	312301

Note: For the connection of a FX3U-1PG to a FX5U/FX5UC base unit, a bus conversion module FX5-CNV-BUSC resp. FX5-CNV-BUS is required.

Positioning module for SSCNET III

FX3S FX3G FX3GC FX3GE FX3U FX3UC FX5U FX5UC

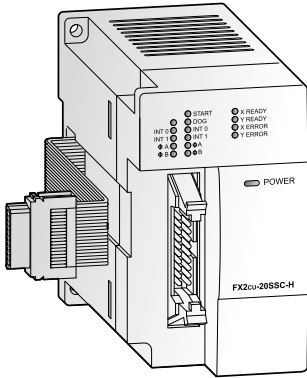

The SSCNET III module FX3U-20SSC-H can be used in combination with a FX3U or FX3UC programmable controller to achieve a cost effective solution for high precision, high-speed positioning. The plug-and-play fiber optic SSCNET III cabling reduces setup time and increases control distance for positioning operations in a wide range of applications.

Servo parameters and positioning information for the FX3U-20SSC-H are easily set up with an FX3U/FX3UC base unit and a personal computer. For parameter setting, monitoring and testing the easy programming software FX Configurator-FP is available.

Specifications	FX3U-20SSC-H
Accessible axes	2 (independent or interpolation)
Output frequency	1 Hz to 50 MHz
Pulse output format	SSCNET III (servo bus)
Communications speed	50 Mbps
Starting time	ms 1.6 (+1.7 SSCNET III cycle time)
Max. to PLC connectable modules	Up to 8 can be connected to the FX3U PLC
Status displays	Power, module status, axis status, error
Power supply	5 V DC 24 V DC
Related I/O points	8
Weight	kg 0.3
Dimensions (WxHxD)	mm 55x90x87
Order information	Art. no. 231512

Notes: The FX3U-20SSC-H can be used in combination with a FX3U or FX3UC base unit only. Please refer to the Mitsubishi Electric MELSERVO catalog for suitable servo motors and amplifiers.

Simple Motion modules

FX3S FX3G FX3GC FX3GE FX3U FX3UC FX5U FX5UC

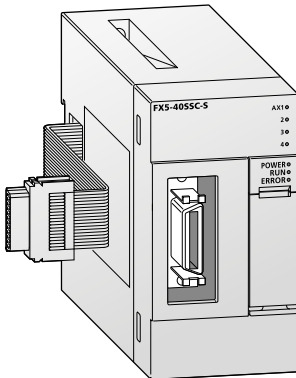

The FX5-40SSC-S 4-axis and FX5-80SSC-S 8-axis Simple Motion modules complement the built-in positioning function of the FX5U or FX5UC* base unit. Similar to positioning modules, these Simple Motion modules are capable of a wide range of high-precision controls, such as positional control, advanced synchronous control, cam control and speed and torque control with setup of even complex motion control functions being done easily by parameters and programming.

The standard encoder signal interface and high-speed inputs for mark detection, for example, enable the system to be used in classical serial machines such as packaging and bottling lines or palletising systems without fitting additional optional modules. A function for automatically calculating the cam data, for example for a rotary cutter application, simply by entering the product length and the synchronization width is also included.

* For the connection to a FX5UC CPU module a connector conversion module FX5-CNV-IFC or an extension power supply module FX5-C1PS-5V is required.

Specifications	FX5-40SSC-S	FX5-80SSC-S
Number of controllable axes	4	8
Interpolation functions	Linear interpolation for up to 4 axes, circular interpolation for 2 axes	
Control system	PTP (point to point) control, trajectory control (both linear and arc), speed control, speed-position switching control, position-speed switching control, speed-torque control	
Mark detection function	Regular mode, specified number of detections mode, ring buffer mode; Mark detection signal: up to 4 points, mark detection setting: 16 settings	
Servo amplifier connection method	SSCNET III/H	
Servo amplifier	MR-JE-B/MR-J4-B/MR-J4W2-B/MR-J4W3-B servo amplifier range	
Operation cycle	1.77 ms	
Power supply	5 V DC 24 V DC	— 250 mA
Related I/O points	8	
Weight	kg 0.3	
Dimensions (WxHxD)	mm 50x90x83	
Order information	Art. no. 281405	304187

Network modules for CC-Link

- FX3S FX3G FX3GC FX3GE FX3U FX3UC FX5U FX5UC

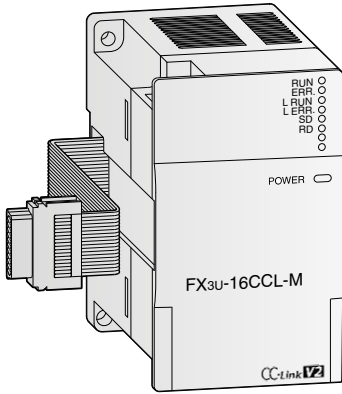

CC-Link master modules

The CC-Link network enables the controlling and monitoring of decentralized I/O modules at the machine.

A CC-Link master module is a special extension module, which assigns an FX3 or iQ-F PLC as the master station of a CC-Link system.

The setting of all modules within the network is handled directly via the master module.

The maximum communications distance is 1200 m without repeater.

The FX5-CCL-MS can be used both as master and intelligent device station.

Specifications	FX3U-16CCL-M ^①	FX5-CCL-MS
Applicable for	Base units FX3G, FX3GC, FX3GE, FX3U, FX3UC, FX5U, FX5UC	Base units FX5U, FX5UC
Module type	Master station	Master/intelligent device station
Link points per station	I/O points	32
	Register	8
Max. number of I/O points	FX3G/FX3GC/FX3GE: 32 x nbr. of stations ≤128 FX3U/FX3UC: 32 x nbr. of stations ≤256 ^②	768
Number of connectable modules	Max. 16	Max. 24
Power supply	5 V DC	—
	24 V DC	240 mA
Related I/O points	8	100 mA
Weight	kg 0.4	0.3
Dimensions (WxHxD)	mm 55x90x87	50x90x83
Order information	Art. no. 248224	312299

① To connect these modules to a FX3UC or FX3GC base unit, an adapter FX2N-CNV-IF or a power supply FX3UC-1PS-5V is required.

More informations about CC-Link are available in various other publications from Mitsubishi Electric.

② Total of I/O points in base unit and extension units within the CC-Link network ≤384.

Notes: Please refer to manual for slave functionality.

For the connection of a FX3U-16CCL-M to a FX5U/FX5UC base unit, a bus conversion module FX5-CNV-BUSC resp. FX5-CNV-BUS is required.

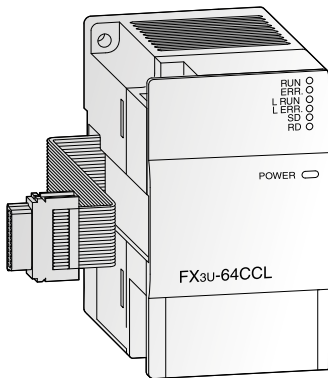

FX3U-64CCL interface module

The FX3U-64CCL CC-Link interface module is available for FX3G, FX3GC, FX3GE, FX3U or FX3UC series main units and enables CC-Link V2

functionality, for example expanded cyclic transmission which facilitates handling of multiple data processes.

Specifications	FX3U-64CCL	
Module type	Intelligent device station	
Link points per station	I/O points	128 (Occupying 1 station with octuple expanded cyclic setting)
	Register	32 (Occupying 1 station with octuple expanded cyclic setting)
Max. transmission speed	10 Mbps	
Related I/O points	8	
Power supply	24 V DC	
Weight	kg	0.3
	mm	55x90x87
Order information	Art. no. 217915	

Notes: When attaching the FX3U-64CCL to a FX3UC/FX3GC base unit, the FX2NC-CNV-IF interface converter or the FX3UC-1PS-5V power supply unit is required.

More informations about CC-Link are available in various other publications from Mitsubishi Electric.

For the connection of a FX3U-64CC to a FX5U/FX5UC base unit, a bus conversion module FX5-CNV-BUSC resp. FX5-CNV-BUS is required.

Network module for CC-Link

- FX3S FX3G FX3GC FX3GE FX3U FX3UC FX5U FX5UC

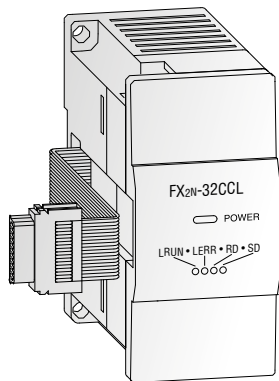

CC-Link communication module

The communication module FX2N-32CCL enables the user to connect to the CC-Link network with a superior PLC system as master CPU. This gives him access to the network of all MELSEC PLC systems and frequency inverters and to additional products from other suppliers.

The buffer memory of the FX2N-32CCL is read and written by FROM/TO instructions.

The connection is to the extension bus on the right side of the controller.

Thus the network is expandable via the digital inputs/outputs of the FX modules to a maximum of 256 I/Os.

Specifications		FX2N-32CCL
Module type		Remote station
Link points per station	I/O points	32
	Register	8
Max. number of I/O points		—
Number of connectable modules		—
Power supply	5 V DC	Max. 130 mA (from base unit)
	24 V DC	50 mA
Related I/O points		8
Weight	kg	0.3
Dimensions (WxHxD)	mm	43x90x87
Order information		Art. no. 102961

Notes: To connect this module to a FX3UC or FX3GC base unit, an adapter FX2N-CNV-IF or a power supply FX3UC-1PS-5V is required. More informations about CC-Link are available in various other publications from Mitsubishi Electric.

Network module for CC-Link IE Field

- FX3S FX3G FX3GC FX3GE FX3U FX3UC FX5U FX5UC

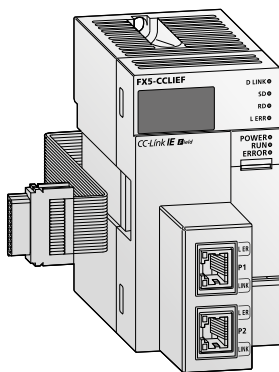

CC-Link IE Field is a high-speed (1 Gbps), high capacity open field network using Ethernet (1000BASE-T).

Data between the FX5 CPU module and the FX5-CCLIEF can be sent/received through the buffer memory using instructions in the program. The data can also automatically exchanged with the auto refresh function and used in a program.

FX5-CCLIEF is an intelligent function module to connect a FX5U or FX5UC* CPU module as an intelligent device station to a CC-Link IE Field network.

* For the connection to a FX5UC CPU module a connector conversion module FX5-CNV-IFC or an extension power supply module FX5-C1PS-5V is required.

Specifications		FX5-CCLIEF
Station type		Intelligent device station
Communication speed		1 Gbps
Max. number of I/O points	RX	384 points, 48 bytes
	RY	384 points, 48 bytes
	RWr	1024 points, 2048 bytes ①
	RWw	1024 points, 2048 bytes ①
Power supply	5 V DC	10 mA
	24 V DC	230 mA (external power supply)
Related I/O points		8
Weight	kg	0.3
Dimensions (WxHxD)	mm	50x90x103
Order information		Art. no. 297444

① 256 points (512 bytes) when the master station is in high-speed mode.

Network modules for Ethernet

- FX3S FX3G FX3GC FX3GE FX3U FX3UC FX5U FX5UC

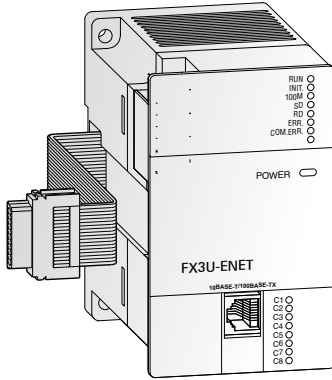

Ethernet communications modules

The FX3U-ENET communications module provides the FX3G, FX3GE, FX3U or FX3UC with a direct connection on to an Ethernet network.

With the FX3U-ENET installed an FX3G/FX3GE/FX3U/FX3UC PLC can exchange data quickly and easily with process visualization systems in addition to supporting full program UP/DOWN load as well as comprehensive monitoring

support. The module also supports Peer to Peer connection and MC Protocol. It is easily set-up with the FX Configurator-EN software.

The FX5U-ENET offers additional Ethernet ports to a FX5U/FX5UC base unit and can be used as master in a CC-Link IE Field Network Basic or for general purpose Ethernet communication. Set-up is easily done with GX Works3.

Specifications	FX3U-ENET/FX3U-ENET-P502	FX5-ENET
Applicable for	Base units FX3G, FX3GC, FX3GE, FX3U, FX3UC	Base units FX5U, FX5UC
Protocol	TCP/IP, UDP	
Communication mode	Full-duplex/half-duplex	
No. of simultaneous open connections	8	
Fixed buffer communication	1023 word x 8	
Communication with mail server	SMTP, POP3	
Interface	IEEE802.3u (100BaseTX), IEEE802.3 (10BaseT)	
CC-Link IE Field Network Basic	—	Master
Connector	RJ45	2xRJ45
Max. transfer rate	100 Mbits/s, 10 Mbit/s	
Max. segment length	m 100	
Cable	CAT5 STP or 3 STP	
Power supply	5 V DC 24 V DC	— 110 mA (from base unit)
Related I/O points	8	
Weight	kg 0.3	0.2
Dimensions (WxHxD)	mm 55x90x87	40x90x83
Order information	Art. no. 166086/225142	409823

Note: To connect this module to a FX3UC base unit, an adapter FX2N-CNV-IF or a power supply FX3UC-1PS-5V is required.

Network module for Ethernet

- FX3S FX3G FX3GC FX3GE FX3U FX3UC FX5U FX5UC

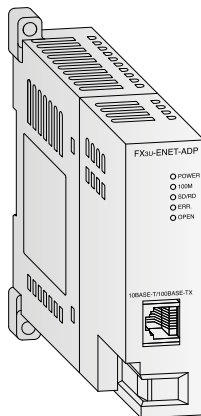

Ethernet communications adapter

The FX3U-ENET-ADP communications adapter is an Ethernet interface with 10BASE-T specifications for the FX3G, FX3GC, FX3S or FX3U series.

The FX3U-ENET-ADP enables upload, download, monitor and test sequence of programs via Ethernet from a personal computer (GX Works2 or MX Components have to be installed).

Specifications	FX3U-ENET-ADP
Protocol	TCP/IP
No. of simultaneous open connections	1
Interface	IEEE802.3u (100BaseTX), IEEE802.3 (10BaseT)
Connector	RJ45 (to Ethernet), 3 screw terminals (to ground)
Max. transfer rate	10 Mbit/s, 100 Mbit/s
Cable	CAT5 STP or 3 STP
Power supply	5 V DC 24 V DC
Related I/O points	0
Weight	kg 0.1
Dimensions (WxHxD)	mm 23x90(106)x81.5

Order information Art. no. 248844

Notes: This module can be connected directly (without adapter) to a base unit of the FX3GC or FX3UC series. To connect this module to a FX3G, FX3S or FX3U base unit, an adapter is required.

Network module for Profibus DP

- FX3S FX3G FX3GC FX3GE FX3U FX3UC FX5U FX5UC

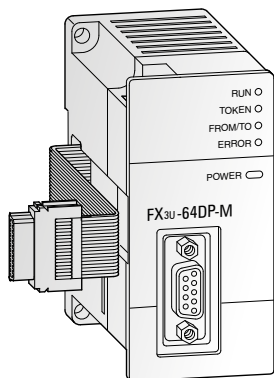

Profibus DP master modul

The Profibus DP master modules FX3U-64DP-M and FX5-DP-M enable you to integrate a MELSEC FX3U/FX3UC or FX5/FX5UC PLC system as a class 1 master of a Profibus DP network.

This interface module provides your base unit with an intelligent Profibus DP link for the implementation of decentralised control tasks.

A FX3U Profibus DP master provides comprehensive data and alarm processing to the Profibus DP V1 standard. The FX3U-64DP-M is easily set up with the GX Configurator-DP software. The FX5-DP-M can be configured within GX Works3 if the Profibus configuration tool is installed.

Specifications	FX3U-64DP-M	FX5-DP-M
Applicable for	Base units FX3U, FX3UC	Base units FX5U, FX5UC
Module type	Master station	
Transmission type	Bus network	
Transmission data	32 byte/slave (normal service mode) 244 byte/slave (extended service mode)	
Interface	Profibus DP (with 9 pole D-SUB connector)	
Max. number of master per configuration	Max. 1	
Repeaters	3	
Max. number of slaves	64	
Communications speed	Profibus standard	
Communications distance	m Max. 1200 (depends on communication speed)	
Communication cable	Profibus cable with 9-pin D-SUB connector	
Power supply	5 V DC 24 V DC	
Related I/O points	8	
Weight	kg 0.2	
Dimensions (WxHxD)	mm 43x90x87	40x90x85.3
Order information	Art. no. 166085	409822
Accessories	Profibus connector up to 12 Mbaud: PROFICON-PLUS, art. no. 140008 or PROFICON-PLUS-PG, art. no. 140009	

Notes: The FX3U-64DP-M can be used in combination with a FX3U or FX3UC base unit only. To connect this module to a FX3UC base unit, an adapter FX2NC-CNV-IF or a power supply FX3UC-1PS-5V is required.

Network module for Profibus DP

- FX3S FX3G FX3GC FX3GE FX3U FX3UC FX5U FX5UC

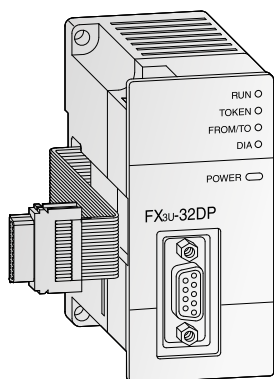

Profibus DP slave module

The FX3U-32DP Profibus DP slave module is available for FX3G, FX3GC, FX3GE, FX3U and FX3UC series main units and allows the attached FX main unit to function as a slave station on a Profibus DP-V1 network.

Profibus DP-V1 functionality supports extensive alarm processing and messaging on top of standard cyclic data exchange.

Specifications	FX3U-32DP
Module type	Slave station
Transmission type	Bus network
Transmission data	Max. 144 bytes
Interface	9-pin D-SUB for Profibus DP
Max. number of slave stations per configuration	8
Communication speed	5 V DC 24 V DC
Communication distance	Max. 1200 (depends on communication speed)
Communication cable	Profibus cable with 9-pin D-SUB connector
Related I/O points	8
Power supply	24 V DC/145 mA (from base unit)
Weight	kg 0.2
Dimensions (WxHxD)	mm 43x90x89
Order information	Art. no. 194214

Note: To connect a FX3U-32DP to a FX3UC/FX3GC base unit, an adapter FX2NC-CNV-IF or a power supply FX3UC-1PS-5V is required.

Remote I/O station for Profibus DP

- FX3S FX3G FX3GC FX3GE FX3U FX3UC FX5U FX5UC

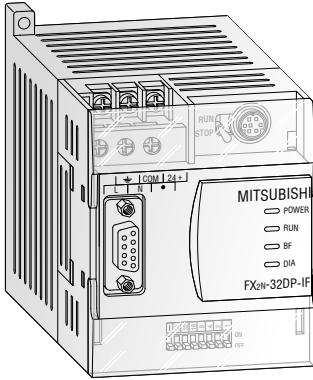

The remote I/O station FX2N-32DP-IF-D forms an extremely compact communication unit and provides a connection of I/O modules with up to 256 I/O points and/or up to 8 special function modules as an alternative.

It features an entire electrical isolation of the Profibus DP connector and of the sensor/actuator circuits.

Profibus data such as the baud rate or I/O data can be monitored directly with the programming software or on the hand-held programming units FX-10P/FX-20P/FX-30P. This facilitates an easy error diagnosis directly on the remote I/O station.

Specifications		FX2N-32DP-IF-D
Power supply		24 V DC (+20 %/-30 %)
Power consumption		14 W
Internal current consumption		5 V DC/max. 220 mA (from base unit)
Interface (connectors)		9-pin D-SUB for Profibus DP, 8-pin Mini-DIN for PC or programming unit FX-10P/FX-20P/FX-30P
Communication speed	1200 m	kbps 9.6/19.2/45.45/93.75
	1000 m	kbps 187.5
	400 m	kbps 500
	200 m	kbps 1500
	100 m	kbps 3000/6000/12000
Communication distance	m	Max. 1200 (depends on communication speed)
Communication cable		Profibus cable with 9-pin D-SUB connector
Max. number of controllable I/O points		256
Weight	kg	0.4
Dimensions (WxHxD)	mm	75x98x87
Order information		Art. no. 142763

Network module for DeviceNet™

- FX3S FX3G FX3GC FX3GE FX3U FX3UC FX5U FX5UC

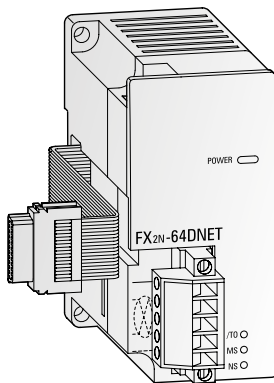

DeviceNet™ slave module

The DeviceNet™ slave module FX2N-64DNET can be used to connect FX3G, FX3GC, FX3GE and FX3U programmable controllers to a DeviceNet™ network.

The FX2N-64DNET can communicate to the master by the master/slave communication (using the master/slave I/O connection), and to

other nodes supporting the UCMM connection by client/server communication (using the UCMM connection).

The communication between the programmable controller and the internal buffer memory of the FX2N-64DNET is handled by FROM/TO instructions.

Specifications		FX2N-64DNET
Module type		Slave (group 2)
Node type		G2 server
Station numbers		0-63 points
Supported communication speeds	kbps	125/250/500
Communication data (open connection)	Master/slave	No. of connections 1 connection (group 2) Transfer time-out 2,000 ms (ACK time-out)
	UCMM client/server	No. of connections 63/63 (group 1, 3)
		Data length Max. 64 bytes per connection
Communication data (I/O connection)	Type	Polling, cyclic, change of state
	Data length	Max. 64 bytes (fragmentation is possible)
Module ID code		K 7090
Status displays		Power, module status, network status
Related I/O points		8
Power supply	5 V DC	120 mA
	24 V DC	50 mA
Weight	kg	0.2
Dimensions (WxHxD)	mm	43x90x87
Order information		Art. no. 131708

Network module for EtherNet/IP

- FX3S FX3G FX3GC FX3GE FX3U FX3UC FX5U FX5UC

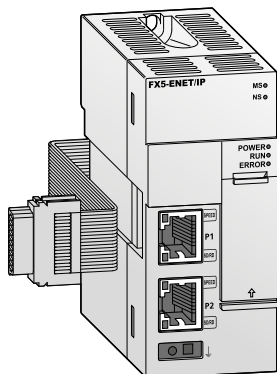

EtherNet/IP communications module

The FX5-ENET/IP allows EtherNet/IP communication (Class 1, Class 3 and UCMM communication) as well as general purpose Ethernet

communication (socket communication). It is easily set-up within GX Works3 if the EtherNet/IP Configuration Tool is installed.

Specifications		FX5-ENET/IP	
		EtherNet/IP communications	Ethernet communications
Number of ports		2 ①	
Number of connectable units		1 module	
Applicable engineering tool		GX Works3: Ver. 1.050C or later, EtherNet/IP Configuration Tool for FX5-ENET/IP: Ver. 1.00A or later	
Protocol type		—	Socket communication
Number of connections		32 ②	Total of 32 connections ③
Transmission specification	Communication mode	Full-duplex	Full-duplex/half-duplex
	Max. segment length m	100 ④	
Connection cable ⑤		100BASE-TX	100BASE-TX, 10BASE-T
Power supply	5 V DC	—	
	24 V DC	110 mA (from base unit)	
Related I/O points		8	
Weight		kg 0.2	
Dimensions (WxHxD)		mm 40x90x83	
Order information		Art. no.	409824

- ① Since the IP address is shared by two ports, only one address can be set.
- ② The total number of connections for Class 3 communications and UCMM communications is 32.
- ③ Up to 32 external devices can access one FX5-ENET/IP module at the same time.
- ④ For maximum segment length (length between hubs), consult the manufacturer of the hub used.
- ⑤ A straight/cross cable can be used.

Network module for CANopen

- FX3S FX3G FX3GC FX3GE FX3U FX3UC FX5U FX5UC

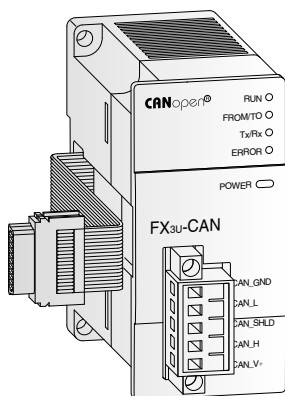

CANopen master module FX3U-CAN

The FX3U-CAN communications module makes it possible to connect a FX3G, FX3GC, FX3GE, FX3U, FX3UC, FX5U or FX5UC PLC to an existing CANopen or CAN Layer-2 network.

In addition to real-time capabilities and high-speed data transfer at rates of up to 1 Mbit/s the CANopen module also shines with high transfer reliability and simple network configuration.

Up to 320 process data objects (PDOs) can be sent or received. With the supported PLC device profile CiA 405 it can be connected with any other CANopen device profile like for example Drives device profile CiA 402, I/O module device profile CiA 401 or Encoder device profile CiA 406.

The CANopen® Lift application profile CiA 417 supports direct control of CANopen® lift devices like Call devices, Drive devices or Lift doors.

Specifications		FX3U-CAN
Module type		CANopen master
CANopen communication standard		CiA 301 V4.2, CiA 302 V4.1, CiA 305 V2.2
CANopen Lift application profile mode		CiA 417 V2.1
CANopen PLC device profile mode		CiA 405 V2.0
Max. number of modules that can be connected to the network		30 without repeater; 127 with repeater
Station numbers		1–127
Supported communication speeds	kbps	10, 20, 50, 125, 250, 500, 800, 1000
Status displays		RUN, error, power, network status
Power supply	5 V DC	290 mA
	24 V DC	—
Related I/O points		8
Weight		kg 0.2
Dimensions (WxHxD)		mm 43x90x88.7
Order information		Art. no. 252845

Notes: To connect this module to a FX3UC/FX3GC base unit, an adapter FX2NC-CNV-IF or a power supply FX3UC-1PS-5V is required. For the connection of a FX3U-CAN to a FX5U/FX5UC base unit, a bus conversion module FX5-CNV-BUSC resp. FX5-CNV-BUS is required.

■ Network module for SAE J1939

- FX3S FX3G FX3GC FX3GE FX3U FX3UC FX5U FX5UC

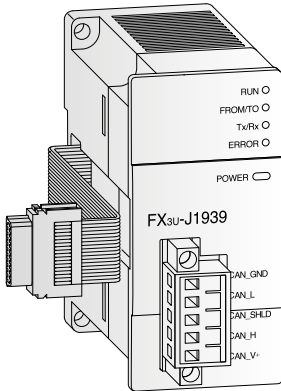

The FX3U-J1939 communication module allows the connection of FX3G/FX3U/FX3UC series PLCs to a SAE J1939 network. SAE J1939 is a CAN based protocol used for communication with motors, generators and compressors.

Up to 75 standard messages and 4 extension messages can be sent and received.

The FX3U-J1939 is compatible with CAN Layer 2 communication. In this mode, a FX3U-J1939 can send and receive up to 42 messages on a CAN network.

In a SAE J1939 network are no master or slave stations. All nodes may receive each others' messages. Standard messages contain up to 8 bytes of data, extended messages contain up to 250 bytes of data.

Specifications	FX3U-J1939
Communication standard version	SAE J1939
Network node size	SAE J1939: 2-30
Communication method	Cyclic, acyclic or request driven (user configurable)
CAN layer-2 communication	Send and receive
Max. cable length	m 5000
Baud rates	kbit/s 10, 20, 50, 100, 125, 250, 500, 800, 1000
Power supply	24 V DC/110 mA (from base unit)
Weight	kg 0.2
Dimensions (WxHxD)	mm 43x90x95
Order information	Art. no. 254276

Note: To connect this module to a FX3UC base unit, an adapter FX2NC-CNV-IF or a power supply FX3UC-1PS-5V is required.

■ AnyWireASLINK system master module

- FX3S FX3G FX3GC FX3GE FX3U FX3UC FX5U FX5UC

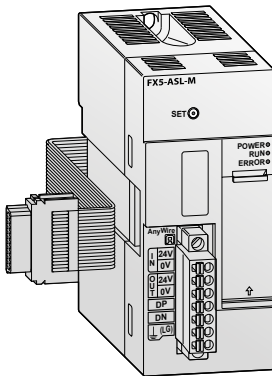

The FX5-ASL-M type AnyWireASLINK system master module is an intelligent function module for building an AnyWireASLINK sensor network.

Specifications	FX5-ASL-M
Module type	AnyWireASLINK system master module
Max. number of I/O points	384
Number of connectable modules	128
Power supply	5 V DC 200 mA 24 V DC 100 mA
Related I/O points	8
Weight	kg 0.2
Dimensions (WxHxD)	mm 40x90x83 (97.3 with connector)
Order information	Art. no. 312300

Modbus® & serial communication special adapter

- FX3S FX3G FX3GC FX3GE FX3U FX3UC FX5U FX5UC

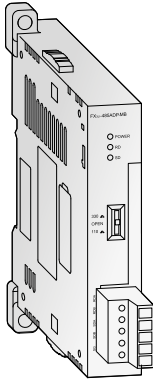

Active data module (RS485)

The addition of an active data interface module permits active communication between the PLC and surrounding devices.

FX3U-485ADP-MB also supports Modbus®/RTU and Modbus® ASCII.

With RS485 communication can be configured as either 1:N multidrop, parallel link or peer to peer operation.

Specifications		FX3U-485ADP-MB
Interface		RS485; Modbus® RS485
Communication speed*	kbps	0.3–19.2
Max. communication distance	m	500
Power supply	5 V DC	20 mA (from base unit)
	24 V DC	—
Related I/O points		0
Dimensions (WxHxD)	mm	17.6x90(106)x74
Order information		Art. no. 206191

* The communication method and communication speed vary depending upon the communication type.

Notes: This adapter module can be connected directly (without special adapter) to a base unit of the FX3GC, FX3GE or FX3UC series. To connect this adapter module to a FX3G, FX3S or FX3U base unit, an adapter is required.

RS485 communication expansion adapter

- FX3S FX3G FX3GC FX3GE FX3U FX3UC FX5U FX5UC

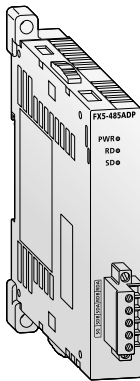

Isolation type communication adapter FX5-485ADP

The expansion adapter FX5-485ADP expands a FX5U or FX5UC base unit by an additional RS485 port. Between the communication line and the base unit photocoupler isolation is used. With the FX5-485ADP the transmission distance can

be increased to 1200 m in contrast to 50 m with the built-in RS485 port or the FX5-485-BD.

Up to two communication expansion adapters can be mounted on the left side of a FX5U or FX5UC CPU base unit.

Specifications		FX5-485ADP
Transmission standard		Conforming to RS485 and RS422 standards
Communication speed*	bps	300/600/1200/2400/4800/9600/19200/38400/57600/115200
Max. communication distance	m	1200 m
External device connection method		Terminal block
Power supply	5 V DC	20 mA (from base unit)
	24 V DC	30 mA (from base unit)
Related I/O points		0
Weight	kg	0.08
Dimensions (WxHxD)	mm	17.6x106x74
Order information		Art. no. 280514

* The communication method and communication speed vary depending upon the communication type.

Interface module

- FX3S FX3G FX3GC FX3GE FX3U FX3UC FX5U FX5UC

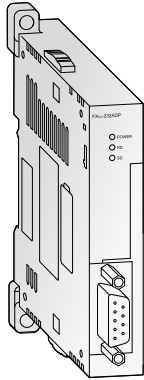

Active data interface module FX3U-232ADP-MB

The additional active data interface module permits active communication between the PLC and surrounding RS232C peripherals. All device information can be sent or received via these interfaces.

The module is suitable for the connection of printers, bar code readers, PCs and other PLC systems. The communication is handled by the PLC program using the RS instruction.

The connection is to the communications bus on the left side of the controller. The internal serial RS422 interface is also fully available.

The FX3U-232ADP-MB can also be used for communication via Modbus®.

Specifications	FX3U-232ADP-MB	
Interface	RS232C with 9 pole D-SUB connector (photocoupler isolation)	
Communication speed*	kbps	0.3–115.2
Power supply	5 V DC	30 mA (from base unit)
	24 V DC	—
Related I/O points	0	
Weight	kg	0.08
Dimensions (WxHxD)	mm	17.6x90(106)x81.5
Order information	Art. no.	206190

* The communication method and communication speed vary depending upon the communication type.

Notes: This module can be connected directly (without adapter) to a base unit of the FX3GC, FX3GE or FX3UC series. To connect this module to a FX3G, FX3S or FX3U base unit, an adapter is required.

RS232C communication expansion adapter

- FX3S FX3G FX3GC FX3GE FX3U FX3UC FX5U FX5UC

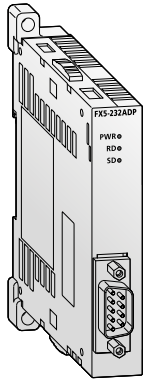

Isolation type communication adapter FX5-232ADP

The expansion adapter FX5-232ADP adds a RS232C port to a FX5U or FX5UC base unit for communication between the PLC and peripheral devices. Between the communication line and the base unit photocoupler isolation is used.

Up to two communication expansion adapters can be mounted on the left side of a FX5U or FX5UC CPU base unit.

Specifications	FX5-232ADP	
Transmission standard	Conforming to RS232C standard	
Communication speed*	bps	300/600/1200/2400/4800/9600/19200/38400/57600/115200
Max. transmission distance	15 m	
External device connection method	9 pole D-SUB connector (male)	
Power supply	5 V DC	30 mA (from base unit)
	24 V DC	30 mA (from base unit)
Related I/O points	0	
Weight	kg	0.08
Dimensions (WxHxD)	mm	17.6x106x74
Order information	Art. no.	280513

* The communication method and communication speed vary depending upon the communication type.

■ Interface module

- FX3S FX3G FX3GC FX3GE FX3U FX3UC FX5U FX5UC

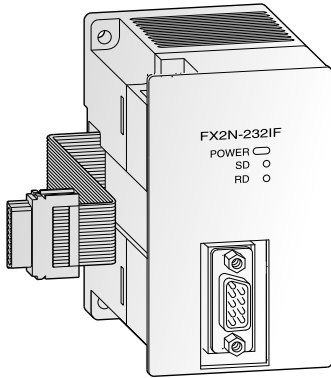

The interface module FX2N-232IF provides an RS232C interface for serial data communications with the MELSEC FX3U and FX3UC.

Communication with PCs, printers, modems, barcode readers etc. is handled by the PLC program.

The send and receive data are stored in the FX2N-232IF's own buffer memory.

Specifications		FX2N-232IF
Interface		RS232C with 9 pole D-SUB connector (photocoupler isolation)
Communication speed	kbps	0.3–19.2
Communication distance	m	Max. 15
Communication cable		Shielded cable
Communication mode		Full duplex
Protocols		Non protocol mode/start stop synchronisation
Send and receive buffer		512 byte each
Format		7 or 8 bits, parity none/even/odd, stop bits: 1 or 2
Power supply	5 V DC	40 mA (from base unit)
	24 V DC	80 mA
Related I/O points		8
Weight	kg	0.3
Dimensions (WxHxD)	mm	55x90x87
Order information		Art. no. 66640

Note: To connect this module to a FX3UC base unit, an adapter FX2NC-CNV-IF or a power supply FX3UC-1PS-5V is required.

Digital extension adapter boards

FX3S FX3G FX3GC FX3GE FX3U FX3UC FX5U FX5UC

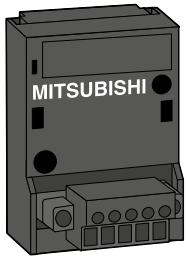

FX3G-4EX-BD

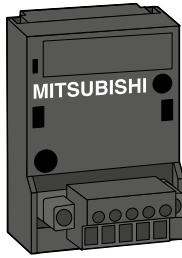

FX3G-2EYT-BD

The extension adapters for the FX3G series are available with 4 inputs or 2 outputs.

They are installed directly in the controller of the FX3S or FX3G series and therefore do not require any additional installation space.

These adapters are especially advantageous when only few additional I/Os are required and there is not enough room for an adjacent module to be installed.

Specifications	FX3G-4EX-BD	FX3G-2EYT-BD
Integrated inputs/outputs	4	
Power supply	From base unit	
Integrated inputs	4	—
Integrated outputs	—	2
Input level	Voltage	24 V DC (+20 %/-15 %)
	Current	5 mA (24 V DC)
Output type	—	Transistor
Max. switching voltage	V	5–30 V DC
Weight	kg	0.02
Dimensions (WxHxD)	mm	35x51.2x29.2
Order information	Art. no.	271700
		271701

Analog adapter boards

FX3S FX3G FX3GC FX3GE FX3U FX3UC FX5U FX5UC

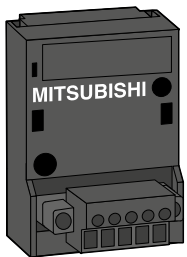

FX3G-2AD-BD

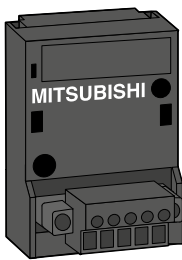

FX3G-1DA-BD

The analog input adapter board FX3G-2AD-BD provides the user with 2 analog inputs.

The board converts analog process signals into digital values which are further processed by the MELSEC FX3S/FX3G/FX3GE controller.

The analog adapter FX3G-1DA-BD provides the user with 1 analog output. This module converts digital values from the FX3S/FX3G/FX3GE controller to the analog signals required by the process.

Specifications	FX3G-2AD-BD	FX3G-1DA-BD
Power supply	From base unit	
Analog channels	Inputs	2
	Outputs	—
	—	1
Analog input range	0–10 V DC/4–20 mA	
Input resistance	Voltage input	kΩ
	Current input	Ω
	198.7	—
External load	Voltage output	kΩ
	Current output	Ω
	—	2–1,000
	—	<500
Resolution	2.5 mV (12 bit)/8 μA (11 bit)	
Fullscale overall accuracy	±1 %	
Conversion speed	Analog → digital	180 μs (1 program cycle)
	Digital → analog	—
	—	60 μs (1 program cycle)
Related I/O points	0	
Weight	kg	0.02
Dimensions (WxHxD)	mm	35x51.2x29.2
Order information	Art. no.	221265
		221266

Analog setpoint adapter board

- FX3S FX3G FX3GC FX3GE FX3U FX3UC FX5U FX5UC

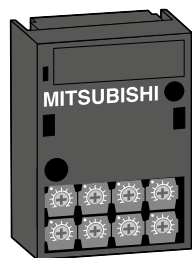

FX3G-8AV-BD

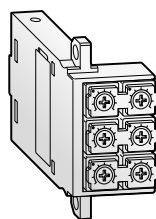

FX3U-8AV-BD

The FX3G-8AV-BD and FX3U-8AV-BD analog setpoint adapter enables the user to set 8 analog setpoint values. The analog values of the potentiometers are read into the controller and used as default setpoint values for timers, counters and data registers by the user's PLC programs.

Setpoint value polling and the definition of the potentiometer scales are performed in the PLC program using the dedicated instructions VRRD/VRSC (FNC85/86).

The analog setpoint adapter is installed in the expansion slot of the CPU. No additional power supply is required for operation.

Specifications	FX3G-8AV-BD	FX3U-8AV-BD
Applicable for	Base units FX3S/FX3G/FX3GE	Base units FX3U
Power supply	From base unit	
Adjusting range	8 Bit	
Related I/O points	0	
Potentiometer evaluation	Via application instruction from the PLC CPU (FNC 85/86)	
Weight	kg	0.02
Dimensions (WxHxD)	mm	35x51.2x12
		19.6x46.1x53.5
Order information	Art. no.	221267
		237307

Communications adapter board

- FX3S FX3G FX3GC FX3GE FX3U FX3UC FX5U FX5UC

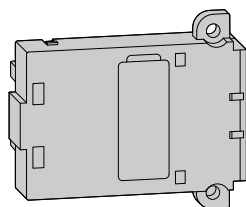
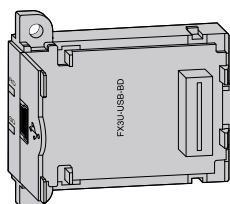

This adapter board allows direct USB 2.0 connection to the front of the FX3U PLC for program maintenance.

Specifications	FX3U-USB-BD
Applicable for	Base units FX3U
Power supply	5 V DC (from base unit)
Weight	kg
	0.02
Dimensions (WxHxD)	mm
	19.6x46.1x53.5
Order information	Art. no.
	165284

Expansion adapters

- FX3S FX3G FX3GC FX3GE FX3U FX3UC FX5U FX5UC

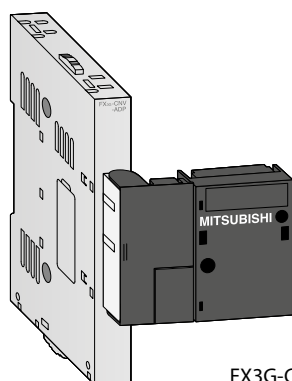

FX3G-CNV-ADP

The below listed expansion adapters enable the connection of the adapter modules FX□□-□□□ADP on the left hand side of the FX3S, FX3G and FX3U base units.

Specifications	FX3G-CNV-ADP	FX3S-CNV-ADP	FX3U-CNV-BD
Applicable for	Base units FX3G	Base units FX3S	Base units FX3U
Weight	kg	0.1	0.01
Dimensions (WxHxD)	mm	90x14.6x86	90x14.6x74
			19.6x46.1x53.5
Order information	Art. no.	221268	267132
			165285

■ Interface adapters

FX3S FX3G FX3GC FX3GE FX3U FX3UC FX5U FX5UC

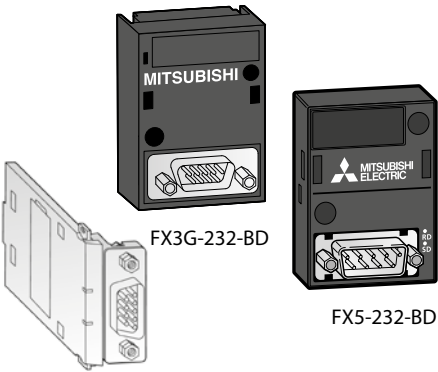

FX3U-232-BD

The FX□□-232-BD interface adapters provide an RS232C interface for serial data communications with the MELSEC FX3S, FX3G, FX3GE, FX3U or FX5U.

Specifications	FX3G-232-BD	FX3U-232-BD	FX5-232-BD
Applicable for	Base units FX3S/FX3G/FX3GE	Base units FX3U	Base units FX5U
Interface	RS232C with 9 pole D-SUB connector		
Power supply	5 V DC/20 mA (from base unit)		
Related I/O points	—		
Weight	kg	0.02	
Dimensions (WxHxD)	mm	35x51.2x17.2	19.3x46.1x62.7
			38x51.4x18.2
Order information	Art. no.	221254	165281
			280511

4

Special function modules

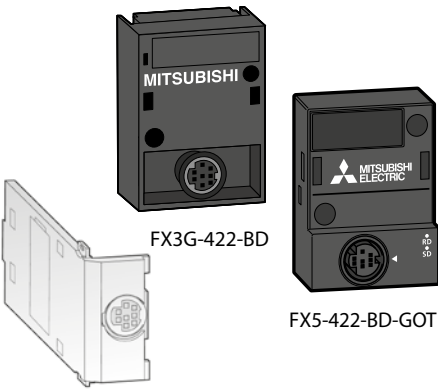

FX3U-422-BD

The interface adapter FX□□-422-BD expand a MELSEC FX3S, FX3G, FX3GE or FX3U PLC to a second RS422 interface for connection of additional devices such as programming devices or HMIs.

The interface adapter FX5-422-BD-GOT is used for the connection of a HMI to a FX5U CPU module.

Specifications	FX3G-422-BD	FX3U-422-BD	FX5-422-BD-GOT
Applicable for	Base units FX3S/FX3G/FX3GE	Base units FX3U	Base units FX5U
Interface	RS422 with 8 pole mini DIN connector		
Power supply	5 V DC/20 mA (from base unit)		
Related I/O points	—		
Weight	kg	0.02	
Dimensions (WxHxD)	mm	35x51.2x14.9	19.6x46.1x53.5
			38x51.4x15.4
Order information	Art. no.	221252	165282
			280515

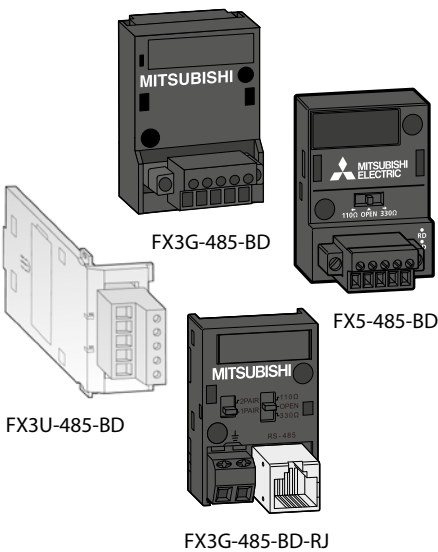

FX3U-485-BD

The interface adapters FX□□-485-BD provide the controller with an additional RS485 interface. The adapter, which is simply inserted into the base unit's expansion slot, enables the

configuration of RS485 1:n multidrop, parallel link or peer-to-peer networks with FX3S, FX3G, FX3GE, FX3U or FX5U systems.

Specifications	FX3G-485-BD	FX3G-485-BD-RJ	FX3U-485-BD	FX5-485-BD
Applicable for	Base units FX3S/FX3G/FX3GE		Base units FX3U	Base units FX5U
Interface	RS485			
Power supply	5 V DC/20 mA (from base unit)		5 V DC/40 mA (from base unit)	5 VDC/20 mA (from base unit)
Related I/O points	—			
Weight	kg	0.02		
Dimensions (WxHxD)	mm	35x51.2x29.2	35x51.2x22	19.6x46.1x69
				38x51.4x30.5
Order information	Art. no.	221253	271699	165283
				280512

Expansion adapter

FX3S FX3G FX3GC FX3GE FX3U FX3UC FX5U FX5UC

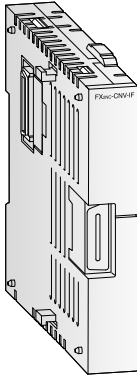

The FX2NC-CNV-IF expansion adapter connects FX3UC main units with the standard FX0N/FX2N/FX3U right side expansion bus.

Specifications	FX2NC-CNV-IF	
Bus connection	FX3UC bus to FX0N/FX2N/FX3U bus	
Weight	kg	0.5
Dimensions (WxHxD)	mm	14.6x90x74
Order information	Art. no.	104508

Connector conversion modules

FX3S FX3G FX3GC FX3GE FX3U FX3UC FX5U FX5UC

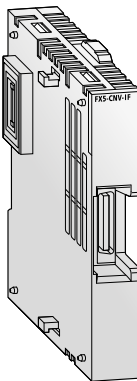

The FX5-CNV-IF is used to connect extension connector type modules of the MELSEC FX5UC series to FX5U CPU module systems.

The FX5-CNV-IFC is used to connect I/O modules (extension cable type) or intelligent modules of the MELSEC FX5U series to FX5UC CPU module systems.

Specifications	FX5-CNV-IF	FX5-CNV-IFC
Conversion type	FX5 (Extension cable type) -> FX5 (Extension connector type)	FX5 (Extension connector type) -> FX5 (Extension cable type)
Compatible CPU module	FX5U	FX5UC
No. of connectable modules	Max. 1	
Power supply	5 V DC	—
	24 V DC	—
Related I/O points	0	
Weight	kg	0.06
Dimensions (WxHxD)	mm	14.6x90x74
Order information	Art. no.	297455 283557

Bus conversion modules

FX3S FX3G FX3GC FX3GE FX3U FX3UC FX5U FX5UC

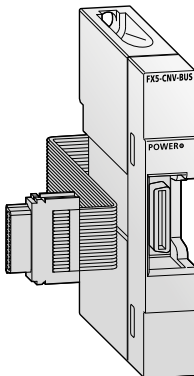

The FX5-CNV-BUS is a conversion module for connecting modules of the FX3 series to an extension cable type FX5 module.

The FX5-CNV-BUSC is a conversion module for connecting modules of the FX3 series to an extension connector type FX5 module.

Specifications	FX5-CNV-BUS	FX5-CNV-BUSC
Conversion type	FX5 (Extension cable type) -> FX3	FX5 (Extension connector type) -> FX3
Compatible CPU module	FX5U, FX5UC ^①	FX5U ^② , FX5UC
No. of connectable modules	Max. 1	
Power supply	5 V DC	150 mA (from base unit)
	24 V DC	—
Related I/O points	8	
Weight	kg	0.1
Dimensions (WxHxD)	mm	16x90x83 14.6x90x74
Order information	Art. no.	280510 283558

^① FX5-CNV-IFC or FX5-C1PS-5V is necessary to connect to FX5UC.

^② FX5-CNV-IF is necessary to connect to FX5U.

Connector conversion adapter

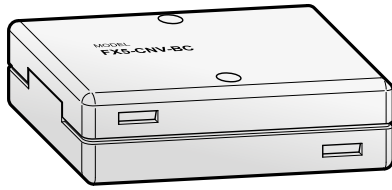

FX5-CNV-BC

- FX3S FX3G FX3GC FX3GE FX3U FX3UC FX5U FX5UC

The FX5-CNV-BC is an adapter to convert the connector of an extended extension cable (FX5-30EC or FX5-65EC) used between modules of extension cable type.

The FX5-CNV-BC is connected and used between the extended extension cable and the module of extension cable type.

Specifications	FX5-CNV-BC
Conversion type	Extended extension cable -> FX5 module (Extension cable type)
Compatible CPU module	FX5U/FX5UC
Weight	kg 0.04
Dimensions (WxHxD)	mm 60.5x40x16.4
Order information	Art. no. 297456

Memory media

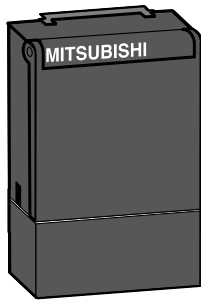

FX3G-EEPROM-32L

- FX3S FX3G FX3GC FX3GE FX3U FX3UC FX5U FX5UC

All FX3S, FX3G, FX3GC and FX3GE base units are equipped with a slot for the optional, robust memory cassette. By connection of this memory cassette, the internal memory of the controller is switched off and only the program specified in the respective memory cassette is run.

The memory cassette can upload/download programs to and from the FX PLC internal memory with the help of 2 buttons.

The memory cassette FX3G-EEPROM-32L can also be mounted on an already installed BD interface or expansion adapter.

Specifications	FX3G-EEPROM-32L
Memory type	EEPROM
Size	32,000 steps (4,000 steps for FX3S)
Protect switch	Provided
Data transfer buttons	Provided
Order information	Art. no. 221269

Memory media

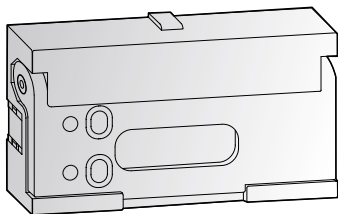

- FX3S FX3G FX3GC FX3GE FX3U FX3UC FX5U FX5UC

The memory cassette can be installed at the main unit, and when installed, the memory cassette's internal program is used in place of the internal RAM memory.

The FX3U-FLROM-64L features additional data transfer buttons.

Specifications	FX3U-FLROM-16	FX3U-FLROM-64	FX3U-FLROM-64L
Applicable for	Base units FX3U/FX3UC		
Size	16,000 steps	64,000 steps	
Memory type	Flash memory		
Protect switch	Provided		
Data transfer buttons	—		Provided
Dimensions (WxHxD)	mm 37x20x6.1		
Order information	Art. no. 165278	165279	165280

Terminal blocks

- FX3S FX3G FX3GC FX3GE FX3U FX3UC FX5U FX5UC

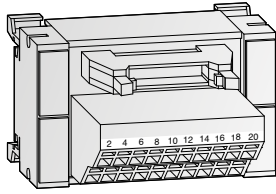

TB-20-C

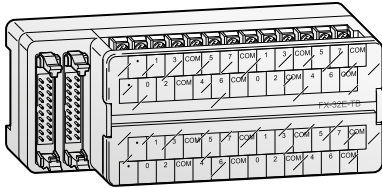

FX-32E-TB/UL

These terminal blocks are adapter modules that simplify the wiring of the inputs and outputs of the FX5UC/FX3UC/FX3GC base units and I/O modules as well as the positioning modules with ribbon cable connectors.

This wiring system is practice-oriented and time-saving.

The FX-32E-TB/UL offers 32 inputs points or 32 output points or 16 input points and 16 output points.

Preconfigured system cabling is available for all the terminal blocks (see next item).

Specifications	TB-20-S	TB-20-C	FX-16E-TB/UL	FX-32E-TB/UL	
Type	Input/output block		Direct input/output block		
Channels	8/16		16	32 or 16/16	
Design	20 pin terminal module				
Connection type	Screw terminals	Spring terminals	Screw terminals		
Dimensions (WxHxD) mm	75x45x52		150x55x45		
Order information	Art. no.	149148	149023	125189	128724
Accessories	Connection cable (see following item)				

Terminal connection cable

- FX3S FX3G FX3GC FX3GE FX3U FX3UC FX5U FX5UC

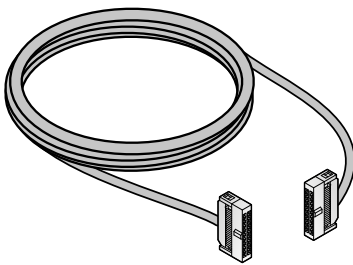

These preconfigured cables enable quick, error-free wiring of the terminal blocks of the FX5UC/FX3UC/FX3GC base units and I/O modules as well as the FX3U/FX3UC positioning modules fitted with ribbon cable connectors.

The cables are available in a choice of lengths between 1 to 5 m. Other lengths are also possible by special order.

Specifications	TB-EX-CAB-1M	TB-EX-CAB-3M	TB-EX-CAB-5M	FX-16E-150CAB-R	FX-16E-300CAB-R	FX-16E-500CAB-R	
Application	For TB-□EX□ and TB-20-□ (1:1 cable)			I/O cable for terminal block			
Length m	1	3	5	1.5	3	5	
Order information	Art. no.	149038	149039	149040	134236	134265	134270

Connection terminals

- FX3S FX3G FX3GC FX3GE FX3U FX3UC FX5U FX5UC

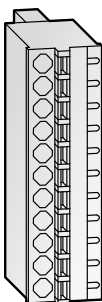

When shipped, many expansion modules for analog or network functions are equipped with a 5 or 10 point terminal block with screws.

These plug-in terminals can easily be replaced with spring terminals if required.

Two replacement terminal units are required for each module with 16 I/Os.

Specifications	TB-CON5-C	TB-CON10-C	
Number of terminal points	5	10	
Connection type	Spring terminals		
Dimensions (WxHxD) mm	12.5x20x21		
Order information	Art. no.	221539	149036

■ 24 V power supply unit

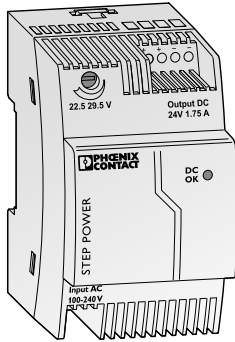

- ALPHA
 FX3S
 FX3G
 FX3GC
 FX3GE
 FX3U
 FX3UC
 FX5U
 FX5UC

The STEP POWER units are a convenient power supply for 24 V units and other external devices. The low standby losses and high degree of efficiency make for maximum power efficiency in its class. The power supply units are available with 24 V DC output voltage in three performance classes and widths.

- Easy assembly on the DIN rail or panel
- Maximum energy efficiency thanks to low idling losses
- Wide temperature range of -25°C to +70°C
- Parallel connection possible for increased performance and redundancy

They can be used worldwide in all industrial sectors due to a wide-range input and an international approval package.

Specifications	STEP-PS/1AC/24DC/0.75	STEP-PS/1AC/24DC/1.75	STEP-PS/1AC/24DC/2.5
Application	Power supply for 24 V DC Alpha base units		
Nominal input voltage	100–240 V (45–65 Hz)		
Nominal output voltage	24 V DC (±1 %)		
Nominal output current	0.75 A (at T=55 °C)	1.75 A (at T=70 °C)	2.5 A (at T=55 °C)
Max. output current	1.4 A	3.75 A	4.4 A
Ambient temperature	-25–70 °C (operation), -40–85 °C (storage)		
Ambient humidity	Max. 95 % (no condensation)		
Weight	kg 0.1	0.2	0.3
Dimensions (WxHxD)	mm 36x90x61	54x90x61	72x90x61
Order information	Art. no. 339434	338294	403063

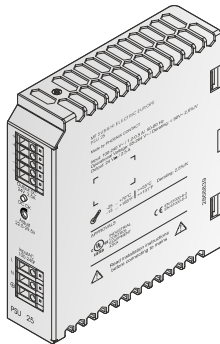

The primary switched-mode power supply units PSU are especially applicable for universal usage in batch mechanical engineering. The wide range input and the UL, cUL certifications allow a worldwide application. The 3-phase units supply the full permanent output power at breakdown of one phase.

The power supply units can be installed in parallel for more power or for redundant mode operation.

The units dispose of an adjustable output voltage, a thermal overload protection circuit and a POWER LED.

Specifications	PSU 25	PSU 50	PSU 100	PSU 200	PSU 200-3
Application	Power supply for all peripheral devices				
Nominal input voltage	100–240 V AC (45–65 Hz)				380–400 V AC
Output voltage	24 V DC				
Max. output current	2.5 A	5 A	10 A	20 A	
Protection	IP20				
Dimensions (WxHxD)	mm 32x130x115	40x130x115	60x130x152.5	115x130x152.5	
Order information	Art. no. 206147	206148	206149	208850	208851
Accessories (PSU 100 or larger)	Wall mounting adapter PSU-UWA, art. no.: 208853				

5 V power supply unit

- FX3S FX3G FX3GC FX3GE FX3U FX3UC FX5U FX5UC

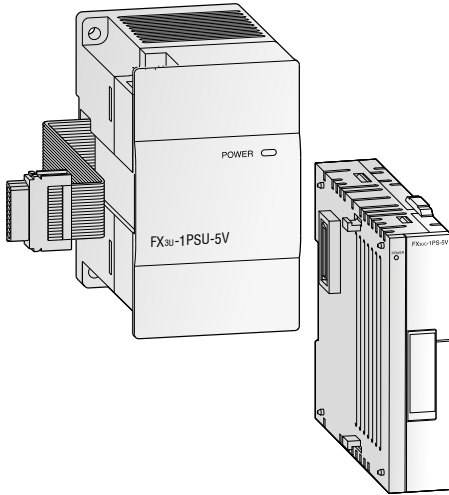

The power supply modules FX3U-1PSU-5V and FX3UC-1PS-5V are used to reinforce the built-in 5 V DC and 24 V DC power supply of a FX3G/FX3GC/FX3GE/FX3U/FX3UC main unit.

Up to two FX3U-1PSU-5V or FX3UC-1PS-5V modules can be used.

Both modules have an integrated overload protection available.

They do not occupy any I/O points and deliver up to 1 A more current for the 5 V system bus (for special function modules).

Specifications	FX3U-1PSU-5V	FX3UC-1PS-5V
Application	Power supply for the FX3G/FX3GE/FX3U/FX5U system bus	Power supply for the FX3GC/FX3UC system bus
General specifications	Conforms to FX family base units	
Nominal input voltage	100–240 V (50/60 Hz)	24 V DC (+20 %/-15 %)
Output voltage	5 V DC/24 V DC	5 V DC
Max. output current	5 V DC	1 A at 40 °C; 0.8 A at 55 °C
	24 V DC	0.3 A at 40 °C; 0.2 A at 55 °C
Max. output current	—	1 A
Ambient temperature	-25–55 °C (operation), -40–85 °C (storage)	
Ambient humidity	Max. 95 % (no condensation)	
Weight	kg	0.3
Dimensions (WxHxD)	mm	55x90x87
Order information	Art. no.	169507
		210091

Notes: The FX3U-1PSU-5V can't be used with a 24 V base unit!
When connecting an input extension module (incl. FX2N-8ER-ES/UL, FX2N-8ER) to the FX3U-1PSU-5V, supply the power for it from the 24 V DC service power supply of the connected main unit or powered extension unit on the upstream side.

Extension power supply modules

- FX3S FX3G FX3GC FX3GE FX3U FX3UC FX5U FX5UC

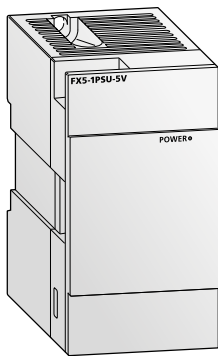

The power supply module FX5-1PSU-5V is used when the FX5U (AC power supply type) CPU module's internal power supply is insufficient. Up to two FX5-1PSU-5V units can be used for one system.

insufficient in the FX5U (DC power supply type) and FX5UC CPU modules. When connecting a module of extension cable type to a FX5UC CPU module, the FX5-C1PS-5V also acts as a connector conversion module. Up to two FX5-C1PS-5V units can be used for one system.

The power supply module FX5-C1PS-5V is required when the built-in power supply is

Specifications	FX5-1PSU-5V	FX5-C1PS-5V
Application	Power supply for FX5U (AC power supply type)	Power supply for FX5U (DC power supply type) and FX5UC
Rated power supply voltage	100–240 V AC (50/60 Hz)	24 V DC
Power consumption	Max. 20 W	Max. 30 W
Output voltage	5 V DC/24 V DC	
Max. output current	5 V DC	1.2 A at 40 °C; 0.8 A at 55 °C
	24 V DC	0.3 A at 40 °C; 0.2 A at 55 °C
No. of connectable modules	Max. 2	
Related I/O points	0	
Weight	kg	0.3
Dimensions (WxHxD)	mm	50x90x83
		20.1x90x74
Order information	Art. no.	280509
		294586

SD memory card

FX3S FX3G FX3GC FX3GE FX3U FX3UC FX5U FX5UC



The built-in SD memory card slot can be used for data logging and convenient program update.

Specifications		SD memory card
Memory	Type	SDHC
Memory capacity		16 GB
Order information	Art. no.	340984

Backup batteries

FX3S FX3G FX3GC FX3GE FX3U FX3UC FX5U FX5UC

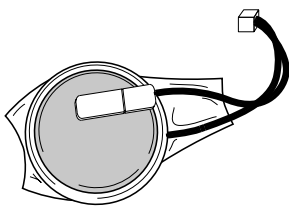

FX3U-32BL

Batteries

The battery buffers the internal RAM of the MELSEC PLC in the event of a voltage failure.

The battery FX3U-32BL can be used for all base units of the MELSEC FX3G/FX3GC/FX3GE/FX3U/FX3UC/FX5U/FX5UC series.

Specifications	FX2NC-32BL	FX3U-32BL
Applicable for	FX2N-20GM module	Base units FX3G/FX3GC/FX3GE/FX3U/FX3UC/FX5U/FX5UC
Order information	Art. no. 128725	165286

Display modules

FX3S FX3G FX3GC FX3GE FX3U FX3UC FX5U FX5UC

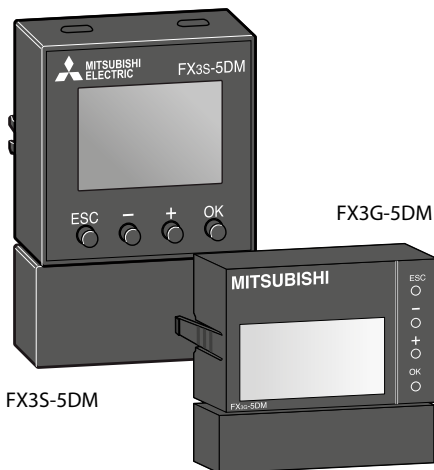

FX3S-5DM

FX3G-5DM

Display modules FX3G-5DM/FX3S-5DM

The display modules FX3G-5DM and FX3S-5DM are inserted directly with space-saving into the controller and enable monitoring and editing of the data stored in the PLC.

A display module e.g. can be used instead of digital switches and external 7-segment displays in very confined areas.

Specifications	FX3S-5DM	FX3G-5DM
Applicable for	Base units FX3S	Base units FX3G/FX3GE
Display	LCD (with backlight)	
Power supply	5V DC $\pm 5\%$ (from base unit)	
Current consumption	mA	n/a
Dimensions (WxHxD)	mm 35x51.2x12	49x34x12
Order information	Art. no. 282202	221270

Control and display panel FX3U-7DM and holder FX3U-7DM-HLD

The FX3U-7DM display module can be incorporated in the main unit, or can be installed in

the enclosure using the FX3U-7DM-HLD display module holder.

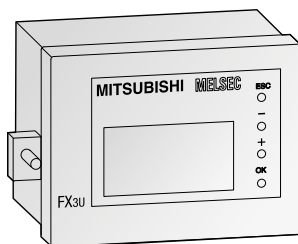

Panel FX3U-7DM with built-in holder FX3U-7DM-HLD

Specifications	FX3U-7DM	FX3U-7DM-HLD
Applicable for	Base units FX3U	
Display	16 letters x 4 lines	—
Resolution	—	—
Power supply	5V DC (from base unit)	—
Current consumption	mA 20	—
Extension cable	—	Included
Weight	kg 0.02	0.01
Dimensions (WxHxD)	mm 48x35x11.5	66.3x41.8x13
Order information	Art. no. 165268	165287

Please refer to the HMI family catalogue for further operator terminals

Cables

- FX3S FX3G FX3GC FX3GE FX3U FX3UC FX5U FX5UC

FX series connection cables

The cable listed in the following tables are used for FX series PLC programming, positioning

applications, block connections and interface conversion.

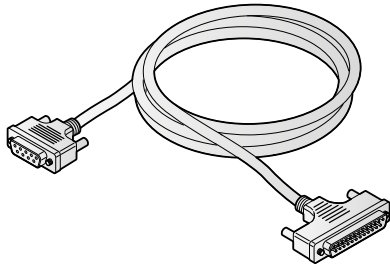

F2-232CAB-1

Connection cable for peripherals

Specifications	F2-232CAB-1	FX-422CAB0	FX-422CAB
Application	PC to FX-232AWC-H		
Peripheral type	RS232C	RS422	
Length	m 3.0	1.5	0.3
Order information	Art. no. 76163	76094	25949

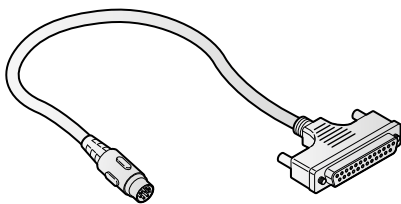

FX-20P-CADP

Connection cable for programming unit

Specifications	FX-20P-CADP
Application	FX-20P-CAB to FX□ PLC
Length	m 0.3
Order information	Art. no. 31870

Connection cable for extension bus

Specifications	FX0N-65EC	FX2N-CNV-BC
Application	PLC bus cable for two-stage-configuration with extension units FX□□-□□ES	Adapter for the connection of the FX0N-65EC to special function modules FX3U/FX2N
Length	m 0.65	
Order information	Art. no. 45348	70880

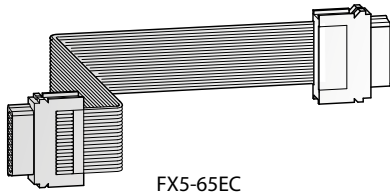

FX5-65EC

Extended extension cables

Specifications	FX5-30EC	FX5-65EC
Application	Connect ion of an extension module located distantly or on a second stage. Depending on the module to be connected with, a connection conversion adapter FX5-CNV-BC is required.	
Length	m 0.3	0.65
Order information	Art. no. 297457	297458

Interface converter

Specifications	FX-USB-AW	FX-232AWC-H
Application	USB to RS422 converter	RS422 to RS232C converter
Dimensions (WxHxD)	mm 62x21x15	80x60x25
Order information	Art. no. 165288	159642

Programming cables

- FX3S FX3G FX3GC FX3GE FX3U FX3UC FX5U FX5UC

The USB to RS422 converter FX-USB-AW is used for the connection between the PLC and a serial interface of a personal computer.

The converter is divided into 2 parts and thus universally applicable for all FX series PLCs.

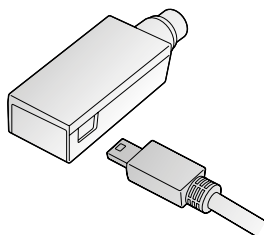

FX-USB-AW

Specifications	FX-USB-AW
Connection on PC side	USB
Order information	Art. no. 165288

■ The ALPHA 2 series

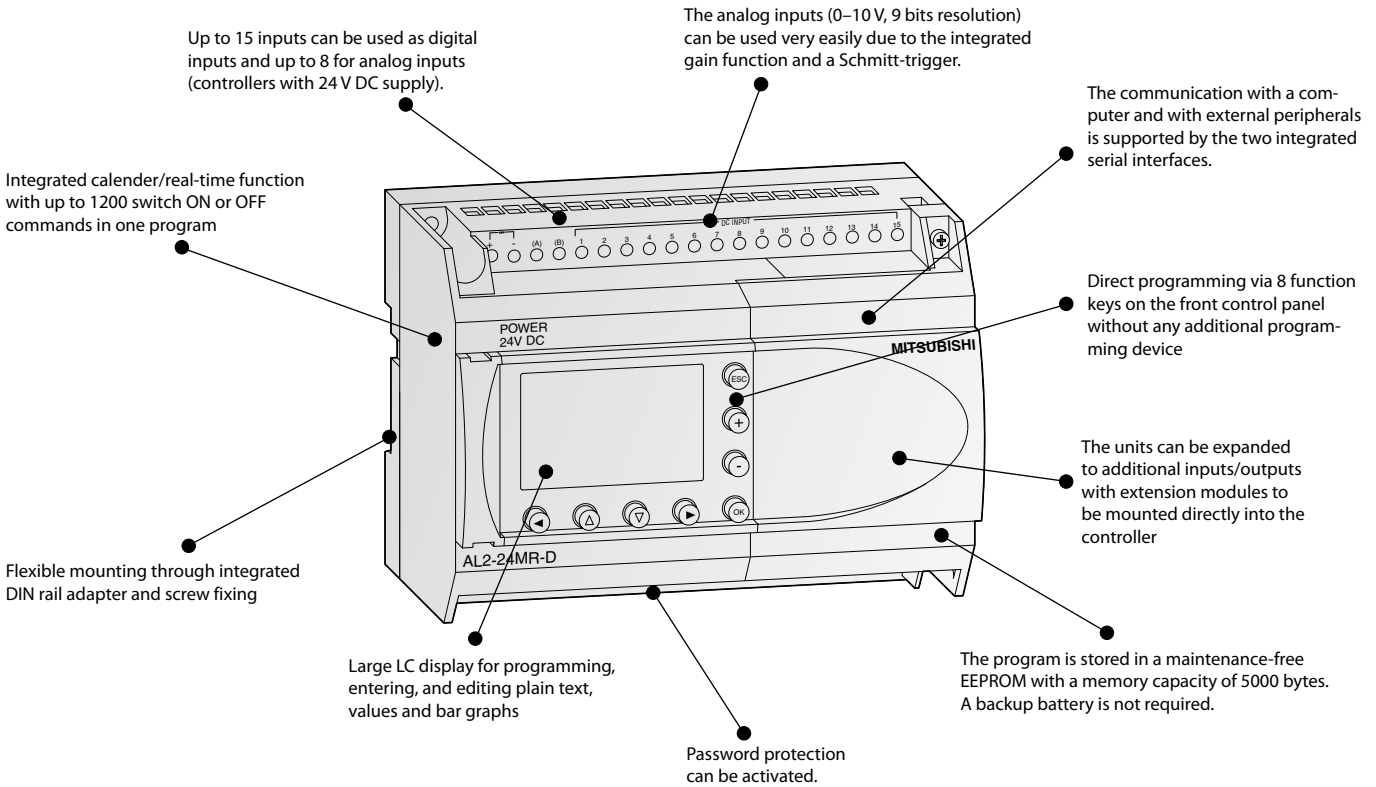

Description of the unit components

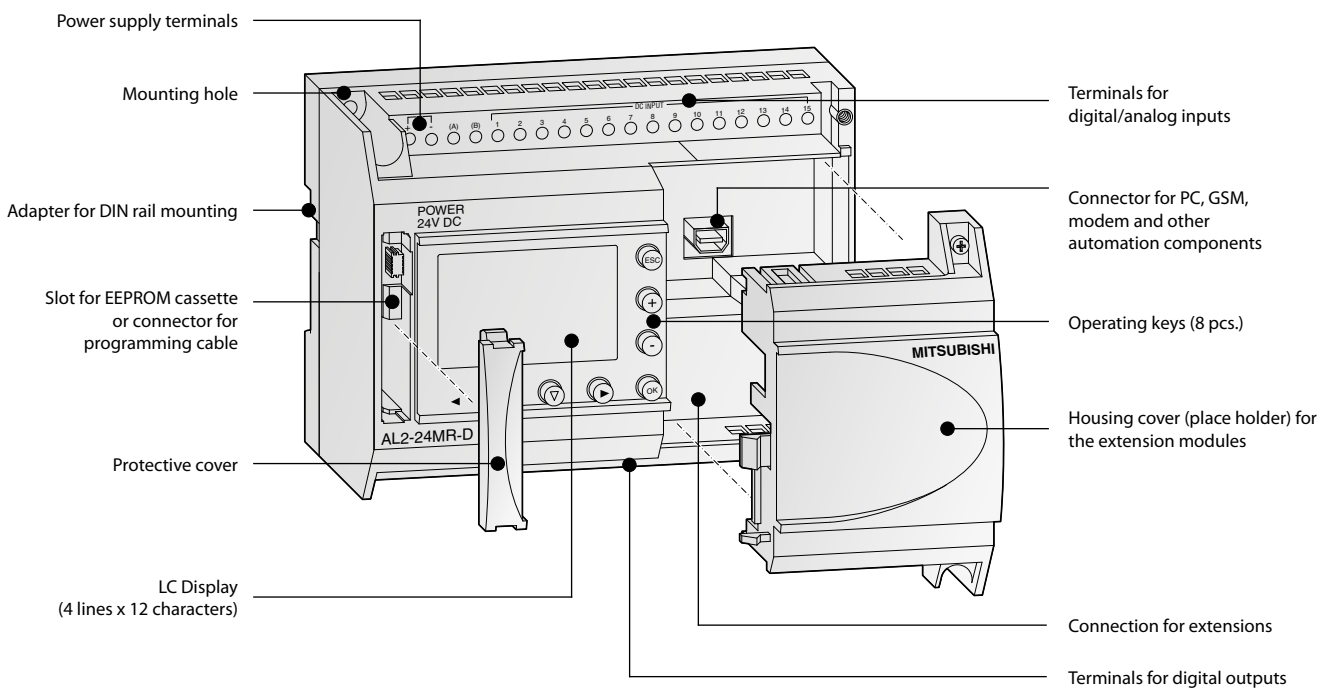

Specifications ALPHA 2

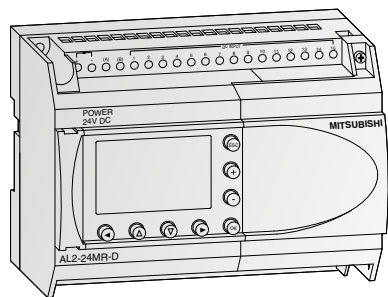

e.g. AL2-24MR-D

ALPHA 2 base units

The ALPHA 2 controllers offer simple reliable control for a range of automation applications including lighting, air conditioning, security systems, and temperature and water control.

- Transistor and relay output options
- Analog input/output
- High speed counters up to 1 kHz
- GSM function for communication with mobile phones
- Language support for 8 different languages
- Display unit for messages and function block data

Base units with 10–24 I/Os

Specifications	AL2-10MR-A	AL2-10MR-D	AL2-14MR-A	AL2-14MR-D	AL2-24MR-A	AL2-24MR-D
Electrical specifications						
Integrated inputs/outputs	10		14		24	
Power supply	100–240 V AC	24 V DC	100–240 V AC	24 V DC	100–240 V AC	24 V DC
Digital inputs	6		8		15	
Analog inputs	—	6	—	8	—	8
Channels	—	6	—	8	—	8
Integrated outputs	4		6		9	
Max. power consumption	W	4.9	4.0	5.5	7.5	7.0
Typ. power consumption	All I/Os	3.5/1.85	2.5/0.75	4.5/2.0	4.0/1.0	5.5/2.5
	ON/OFF	240 V AC	120 V AC	240 V AC	120 V AC	240 V AC
Weight	kg	0.2		0.3	0.35	0.3
Dimensions (WxHxD)	mm	71.2x90x55		124.6x90x52		
Order information						
Art. no.	215070	215071	215072	215073	215074	215075

Environmental specifications

General specifications		Alpha 2 series
Ambient temperature		Display: -10–55 °C, Hardware: -25–55 °C (storage temperature: -30–70 °C)
Protection rating		IP20
Noise immunity		1,000 Vpp with noise generator; 1 µs at 30–100 Hz, tested by noise simulator
Dielectric withstand voltage		3,750 V AC, > 1 min. according to EN 60730
Allowable relative humidity		35–85 % (no condensation)
Shock resistance		Acc. to IEC 68-2-27: 147 m/s ² acceleration, 11 ms 3x3 directions
Vibration resistance	Direct mounting	Acc. to IEC-2-6: 19.6 m/s ² acceleration, 80 min. in each direction
	DIN rail mounting	Acc. to IEC-2-6: 9.8 m/s ² acceleration, 80 min. in each direction
Insulation resistance		500 V DC, 7 MΩ acc. to EN60730-1
Ambient conditions		No corrosive gases, no dust
Certifications		Please refer to pages 101–103

Electrical specifications

Power supply specifications		DC powered modules (AL2-□MR-D)	AC powered modules (AL2-□MR-A)
Power supply		24 V DC	100–240 V AC (50/60 Hz)
Inrush current at ON		≤7.0 A (at 24 V DC)	≤6.5 A (at 240 V AC)
Allowable momentary power failure time		5 ms	10 ms
Digital Inputs			
Input voltage		24 V DC (+20 %/-15 %)	100–240 V AC (+10 %/-15 %), 50/60 Hz
Input current		The input current changes depending on Source or Sink.	
		For Sink: (AL2-10/14/24MR-D) = 5.5 mA, 24 V DC For Source: (AL2-10/14MR-D) = 6.0 mA, 24 V DC (AL2-24MR-D) = 5.5 mA, 24 V DC	101–108 0.13 mA/120 V AC* 0.25 mA/240 V AC* 109–115 0.15 mA/120 V AC* 0.29 mA/240 V AC*
Response time	OFF→ON	ms	10–20
	ON→OFF	ms	10–20
Analog inputs			
Digital output range		0–500	—
Resolution		9 bit, (10 V/500)	—
Conversion speed	ms	8	—
Voltage		0–10 V DC	—
Impedance	kΩ	142 ±5 %	—
Accuracy		±5 % (0.5 V DC)	—

* Current leakage from the sensors connected to the inputs might provide enough current to turn the controller ON. Do not use two wire sensors.

Output specifications		All modules
Type		Relay
Switching voltage (max.)	V	250 V AC, 30 V DC
Rated current		10M, 14M: 8 A/point
		24M (001-004): 8 A/point
		24M (005-009): 2 A/point
Max. switching load	- inductive load	14M, 24M: 249 VA, 250 V AC/373 VA, 250 V AC 24M: 93 VA, 125 V AC/93 VA, 250 V AC
Minimum load		10 mA, 5 V DC
Response time	ms	≤10

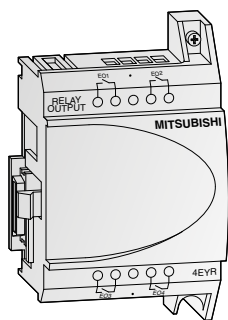

Digital extension modules

There are 4 different extension modules available for the ALPHA 2, which allow the controller to be extended through additional inputs or outputs. The modules are inserted directly into the ALPHA 2 and therefore do not take up any additional space.

The AL2-4EX has the additional feature that 2 inputs may be used as high-speed counters with a counting frequency of 1 kHz.

All modules feature photocoupler insulation for all I/Os.

Digital extension modules specifications		AL2-4EX-A2	AL2-4EX	AL2-4EYR	AL2-4EYT
Inputs					
Integrated inputs		4		—	
Input voltage		220–240 V AC	24 V DC (+20 %, -15 %)	—	
Input current		7.5 mA at 240 V AC (50 Hz), 9.0 mA at 240 V AC (60 Hz)	5.4 mA ±1 mA at 24 V DC	—	
Outputs					
Integrated outputs		—		4	
Output type		—		Relay	Transistor
Switched voltage (max.)		V		250 V AC, 30 V DC	5–24 V DC
Rated current		A		2 A per output	1 A per output
Electrical specifications					
Power supply	AC range (+10 %, -15 %)	220–240 V AC	24 V DC	100–240 V AC	24 V DC
Mechanical specifications					
Weight	kg	0.05			
Dimensions (WxHxD)	mm	53.1x90x24.5			
Order information					
	Art. no.	142522	142521	142523	142524

Note: I1 and I2 of the AL2-4EX can be used as high-speed counter inputs. In each case the response time for the high-speed counter inputs will be 0.5 ms or less. The AL2-4EX-A2, AL2-4EX, AL2-4EYR and AL2-4EYT modules can not be used with the AL2-10MR series.

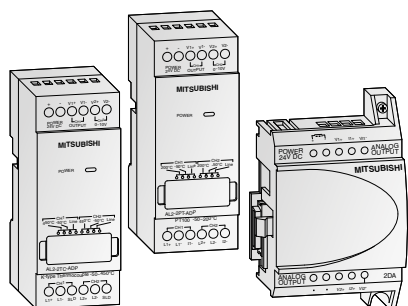

Analog extension modules

The analog extension modules significantly increase the range of applications for the ALPHA 2. With these modules it is possible to output voltage or current signals or to measure temperatures.

Three different analog extension modules are available:

The AL2-2DA offers two additional analog outputs for the ALPHA 2 and converts a digital input value into a voltage or a current. This module is inserted directly into the ALPHA 2.

The AL2-2PT-ADP connects an external Pt100 sensor to convert temperature readings into analog signals (0–10 V).

The AL2-2TC-ADP connects thermocouple sensors (K type) to convert temperature readings into analog signals (0–10 V).

Analog extension modules specifications		AL2-2DA	AL2-2PT-ADP	AL2-2TC-ADP
Analog inputs				
Integrated inputs		—	2	
Connectable temperature sensors		—	Pt100 sensor Temp. coefficient 3.850 ppm/°C (IEC 751)	Thermocouple (K type), isolated type (IEC 584-1 1977, IEC 584-2 1982)
Compensated range		—	-50–200 °C	-50–450 °C
Analog outputs				
Integrated outputs		2	—	
Analog output range	Voltage	0–10 V DC (5 kΩ–1 MΩ)	—	
	Current	4–20 mA (max. 500 Ω)	—	
Electrical specifications				
Number of channels		2		
Power supply		24 V DC (-15–10 %), 70 mA	24 V DC (-15–20 %), 1 W	
Mechanical specifications				
Weight	kg	0.05	0.07	
Dimensions (WxHxD)	mm	53.1x90x24.5	35.5x90x32.5	
Order information				
	Art. no.	151235	151238	151239

Note: the AL2-2DA module can not be used with the AL2-10MR series

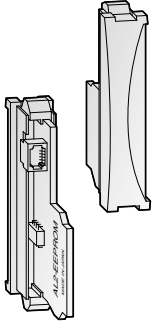

Memory cassette AL2-EEPROM-2 memory media

With the AL2-EEPROM-2 memory cassettes, a new program can be transferred to the ALPHA 2 controller's internal system memory from the cassette, or the program of the internal system memory can be saved to the cassette.

If the memory cassette is used, a certain program can be run temporarily by simply plugging the external memory module onto the ALPHA 2.

After removing the memory cassette, the former program in the internal memory becomes active again.

The memory cassette AL2-EEPROM-2 is not a memory expansion device, but a medium for data exchange.

Specifications	AL2-EEPROM-2	
Memory type	EEPROM	
Application	ALPHA 2	
Memory capacity	5,000 bytes	
Function blocks	Max. 200	
Dimensions (WxHxD)	mm	10x45x25
Order information	Art. no.	142526

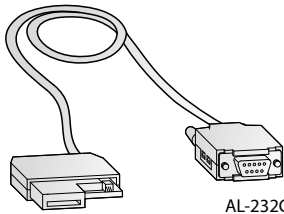

AL-232CAB

Interface cable AL-232CAB

The AL-232CAB is an RS232C interface cable. It connects the ALPHA 2 controller to a personal computer running the programming software for the ALPHA 2 controller.

The cable ensures a galvanic isolation between the ALPHA 2 controller and the personal computer. The cable AL-232CAB can not be used for any other connection.

GSM cable AL2-GSM-CAB

The GSM AL2-GSM-CAB is an RS232C interface cable and it is used to connect the ALPHA 2 controller to a normal or GSM modem, a personal computer or other serial devices. It can transfer SMS data to a GSM modem for onward transmission to mobile telephones or e-mail addresses. It also permits remote monitoring and remote maintenance.

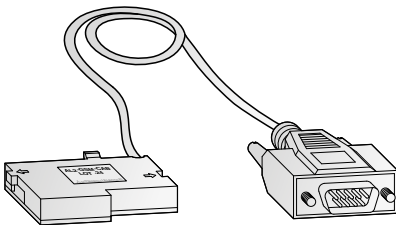

AL2-GSM-CAB

Specifications	AL-232CAB	AL2-GSM-CAB
Connector	9-pin D-SUB female connector	9-pin D-SUB male connector
Application	ALPHA 2 <-> PC	ALPHA 2 <-> PC, modem
Length	m 2.5	1.5
Order information	Art. no. 87674	142528

Note: The above cables cannot be used with the AL2-10MR series.

Base units FX5U

MELSEC-F series MELSEC iQ-F series

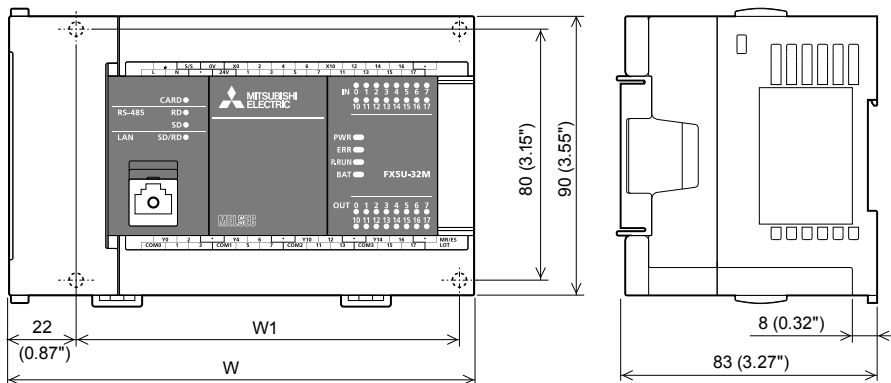

Base units	W	W1
FX5U-32M□	150	123
FX5U-64M□	220	193
FX5U-80M□	285	258

All dimensions in mm

Base units FX5UC

MELSEC-F series MELSEC iQ-F series

FX5UC-32M□, FX5UC-64M□, FX5UC-96M□

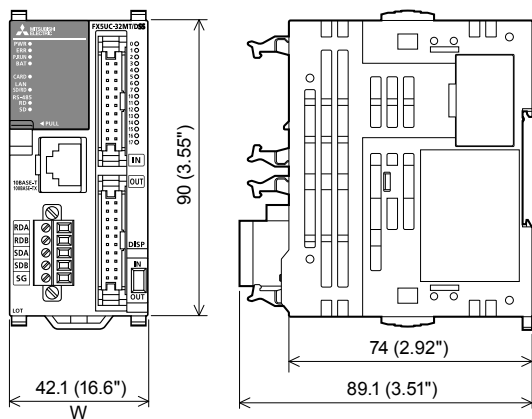

Base units	W
FX5UC-32M□	42.1
FX5UC-64M□	62.2
FX5UC-96M□	82.3

FX5UC-32MR/DS-TS, FX5UC-32MT/DS-TS, FX5UC-32MT/DSS-TS

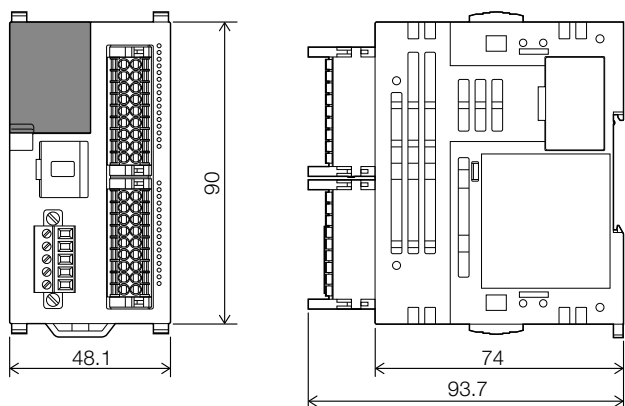

Type	W
FX5UC-32MR/DS-TS	68.2
FX5UC-32MT/DS-TS	48.1
FX5UC-32MT/DSS-TS	48.1

All dimensions in mm

Base units

Base units FX3S

MELSEC-F series MELSEC iQ-F series

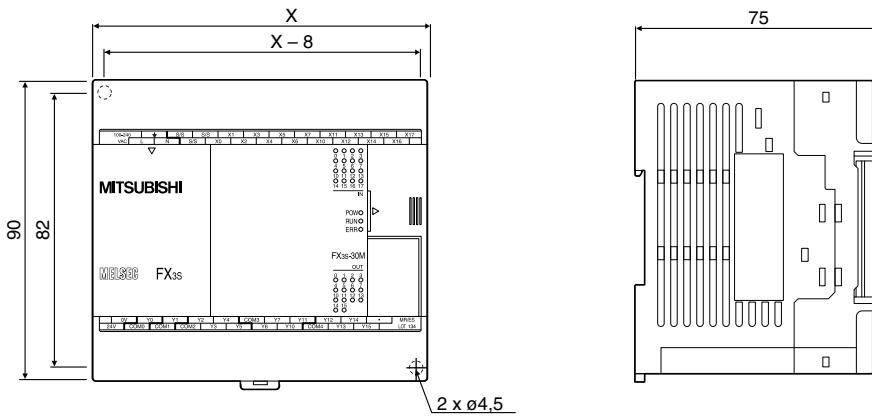

Base units	X
FX3S-10MR-ES	60
FX3S-10MT-ESS	60
FX3S-14MR-ES	60
FX3S-14MT-ESS	60
FX3S-20MR-ES	75
FX3S-20MT-ESS	75
FX3S-30MR-ES	100
FX3S-30MT-ESS	100

All dimensions in mm

Base units FX3G

MELSEC-F series MELSEC iQ-F series

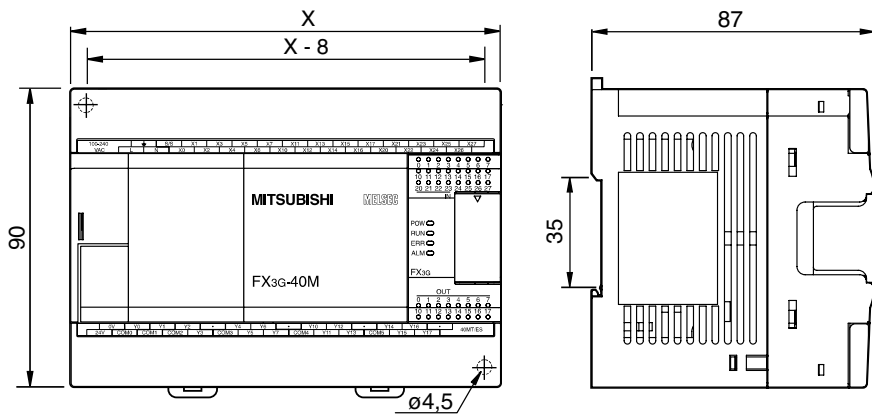

Base units	X
FX3G-14	90
FX3G-24	90
FX3G-40	130
FX3G-60	175

All dimensions in mm

Base units FX3GE

MELSEC-F series MELSEC iQ-F series

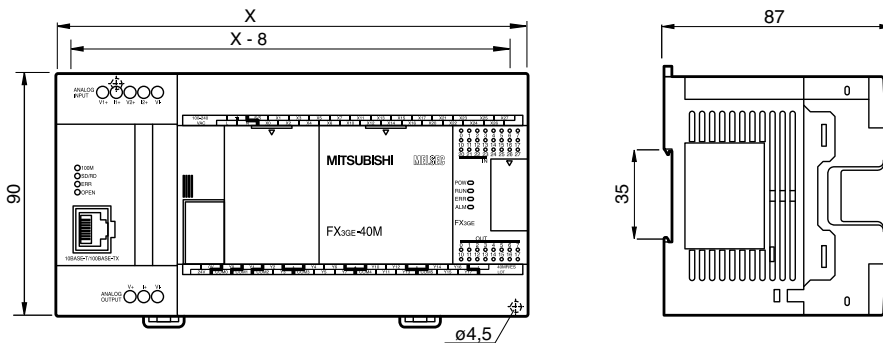

Base units	X
FX3GE-24	130
FX3GE-40	175

All dimensions in mm

Base units FX3GC

MELSEC-F series MELSEC iQ-F series

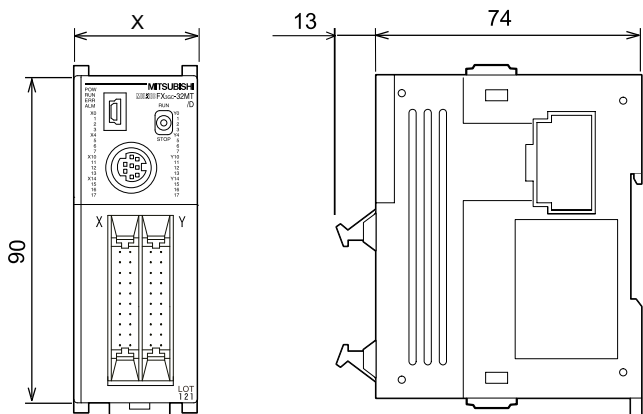

Base units	X
FX3GC-32MT/DSS	35

All dimensions in mm

Base units FX3U

MELSEC-F series MELSEC iQ-F series

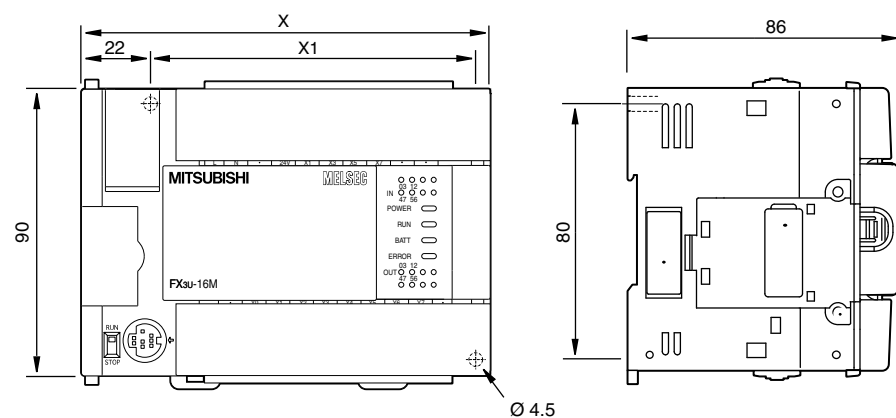

Base units	X	X1
FX3U-16M□□□	130	103
FX3U-32M□□□	150	123
FX3U-48M□□□	182	155
FX3U-64M□□□	220	193
FX3U-80M□□□	285	258
FX3U-128M□□□	350	323

All dimensions in mm

Base units FX3UC

MELSEC-F series MELSEC iQ-F series

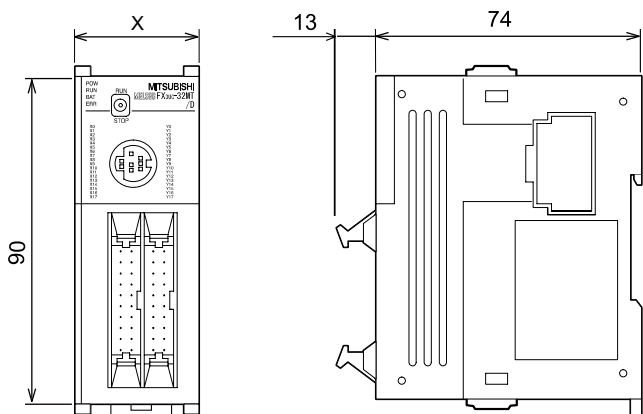

Base units	X
FX3UC-16MT/DSS	34
FX3UC-32MT/DSS	34
FX3UC-64MT/DSS	59.7
FX3UC-96MT/DSS	85.4

All dimensions in mm

Extension units

Input module/output modules FX5 (extension cable type), high-speed pulse input/output modules

MELSEC-F series MELSEC iQ-F series

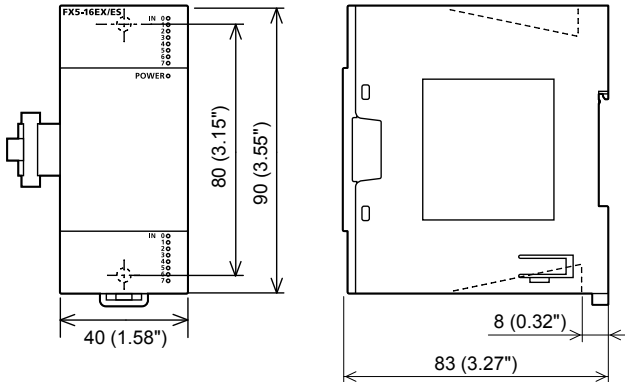

All dimensions in mm

Powered input/output modules FX5

MELSEC-F series MELSEC iQ-F series

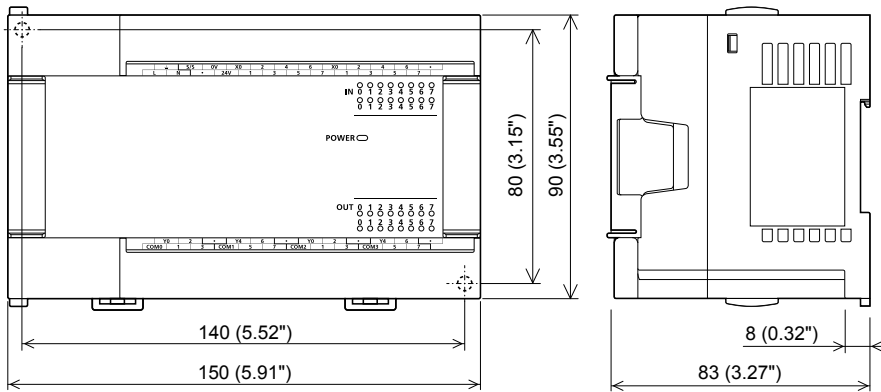

All dimensions in mm

Input/output modules FX5 (extension connector type)

MELSEC-F series MELSEC iQ-F series

FX5-C□EX/□, FX5-C□EYT/□

FX5-C32ET/D, FX5-C32ET/DSS

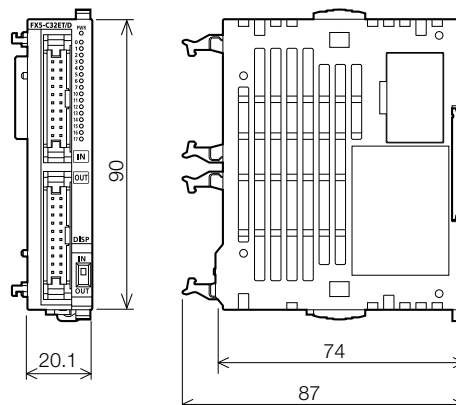
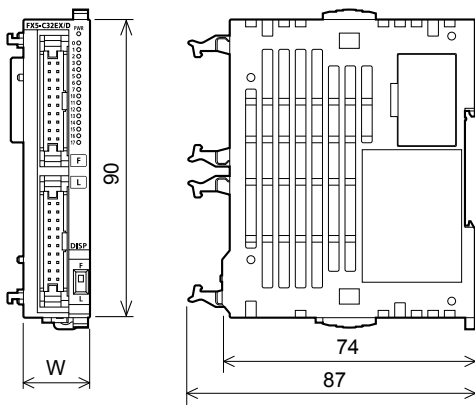

All dimensions in mm

Type	W
FX5-C16EX/D, FX5-C16EX/DS, FX5-C16EYT/D, FX5-C16EYT/DSS	14.6
FX5-C32EX/D, FX5-C32EX/DS, FX5-C32EYT/D, FX5-C32EYT/DSS	20.1

**Input module/output module/I/O module
(spring clamp terminal block type)**

MELSEC-F series MELSEC iQ-F series

FX5-C16EYR/D-TS

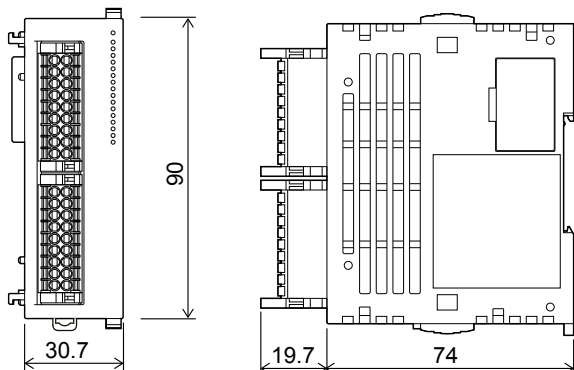

Type	W
FX5-C16EYR/D-TS	30.7
FX5-C32ET/DSS-TS	20.1
FX5-C32EX/DS-TS	20.1
FX5-C32EYT/DSS-TS	20.1

FX5-C32□/D(S(S))-TS

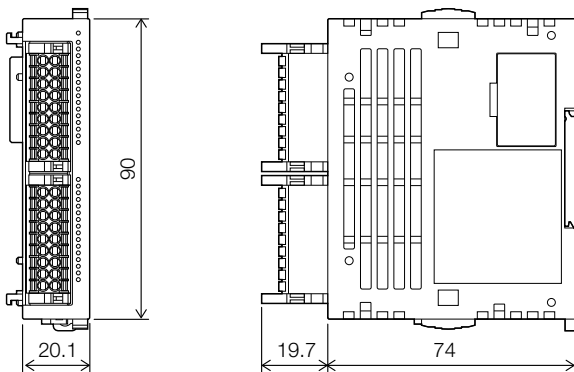

All dimensions in mm

Adapter modules and extension adapters FX3U

MELSEC-F series MELSEC iQ-F series

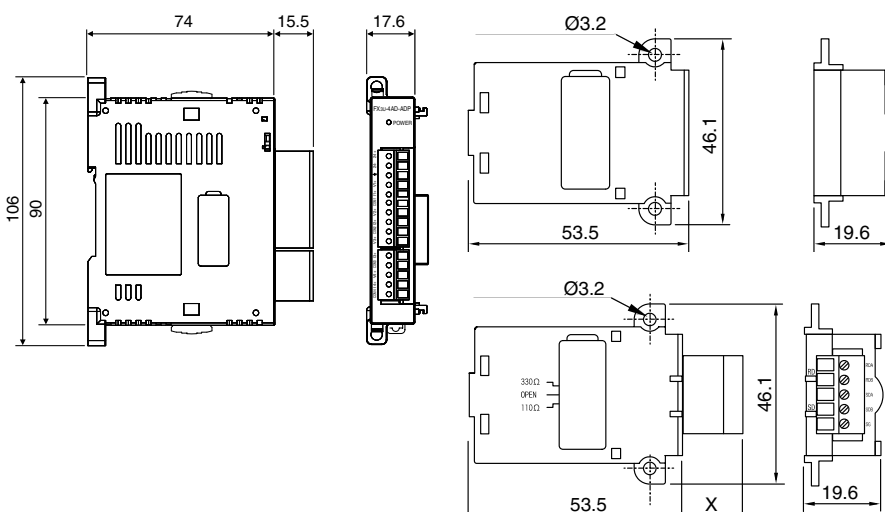

Type	X
FX3U-CNV	—
FX3U-USB	—
FX3U-485	15.5
FX3U-422	—
FX3U-232	9.2

All dimensions in mm

Extension units

Compact extension units and modular extension blocks FX2N

MELSEC-F series MELSEC iQ-F series

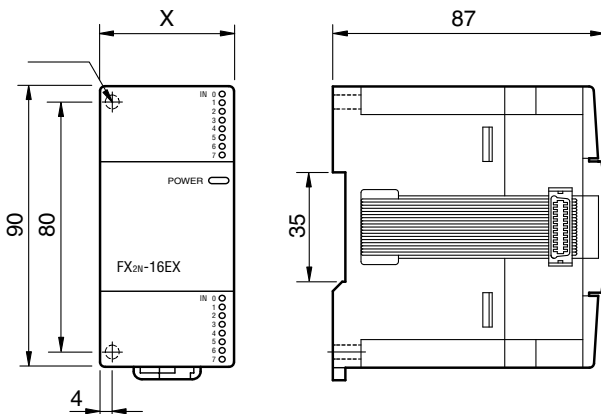

Compact extension units

Type	X
FX2N-32E□□□	150
FX2N-48E□□□	182
FX2N-48ER-UA1/UL	220

Modular extension blocks

Type	X
FX2N-8E□□□	43
FX2N-16E□□□	40

All dimensions in mm

7

Modular extension blocks FX2NC

MELSEC-F series MELSEC iQ-F series

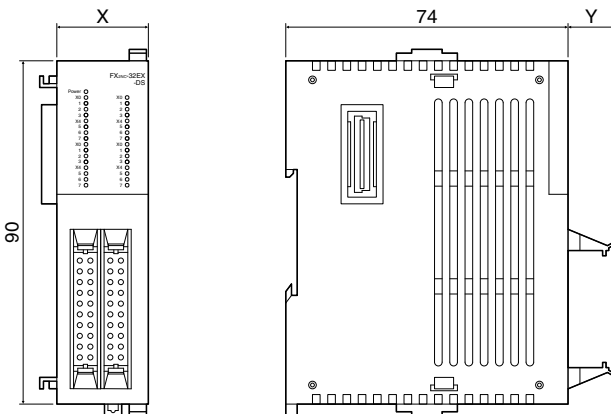

Type	X	Y
FX2NC-16EX-DS	14.6	13
FX2NC-16EYT-DSS	14.6	13
FX2NC-16EX-T-DS	20.2	15
FX2NC-16EYR-T-DSS	24.2	15
FX2NC-32EX-DS	26.2	13
FX2NC-32EYT-DSS	26.2	13

All dimensions in mm

Intelligent function modules FX5

MELSEC-F series MELSEC iQ-F series

FX5-40SSC-S/FX5-80SSC-S

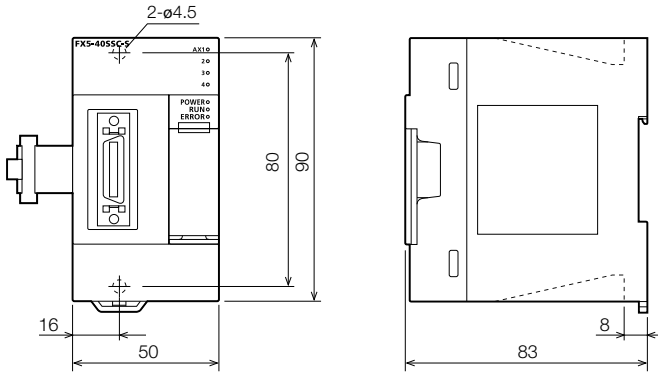

FX5-8AD

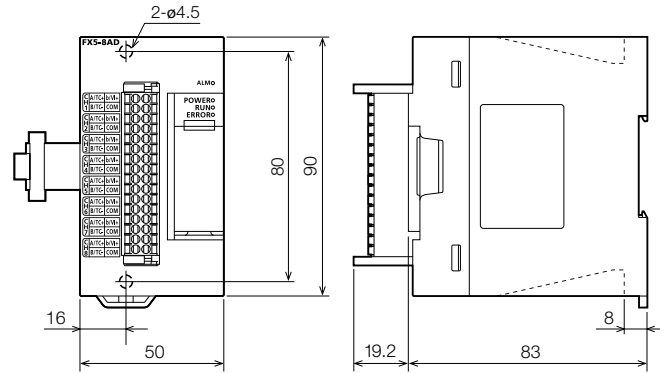

FX5-4LC

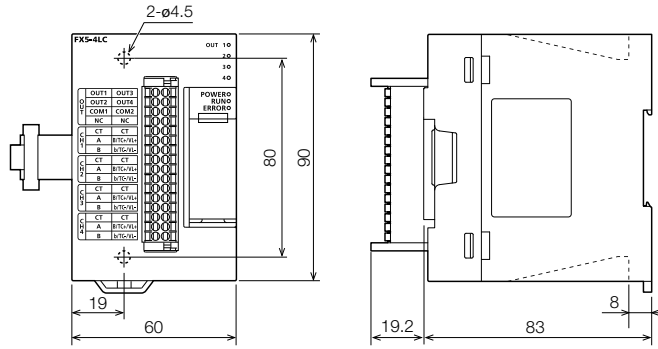

FX54AD, FX5-4DA

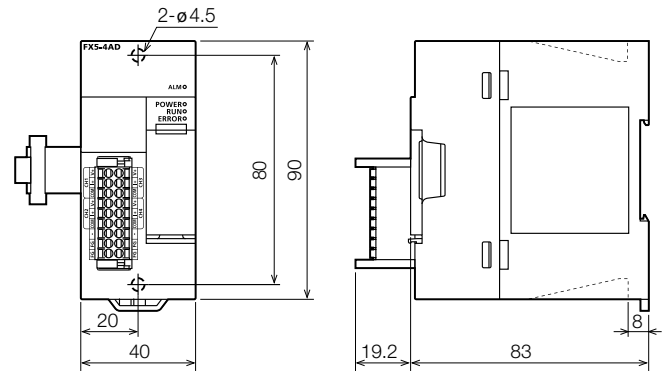

FX5-CCL-MS

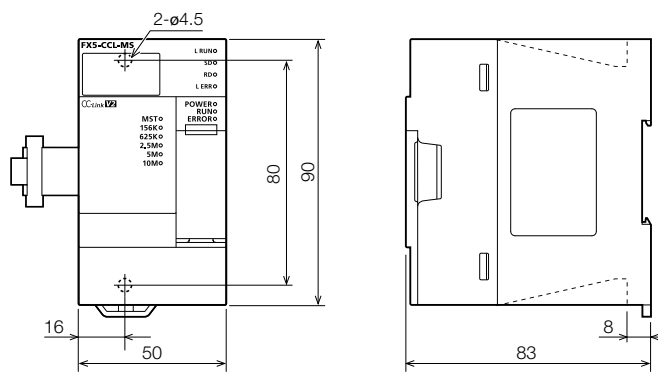

FX5-20PG-P

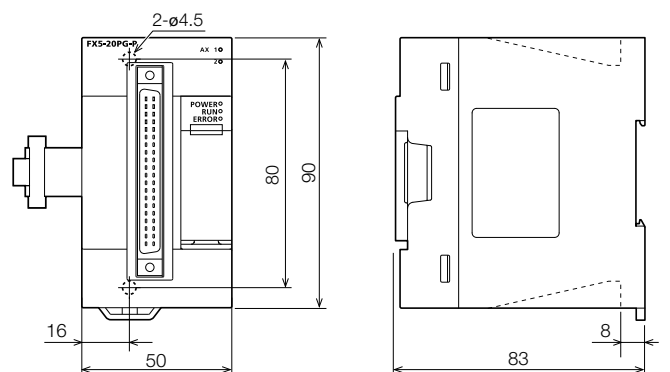

All dimensions in mm

Special function modules

FX5-ASL-M

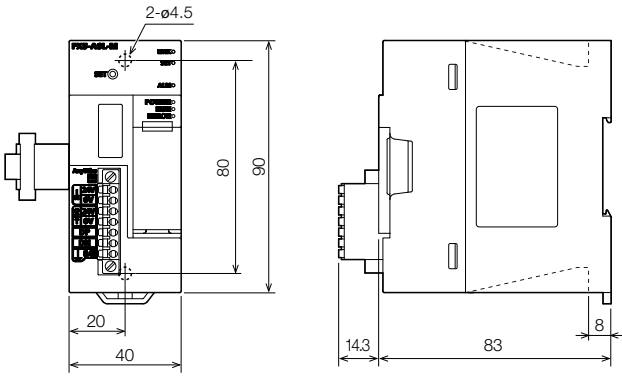

FX5-CCLIEF

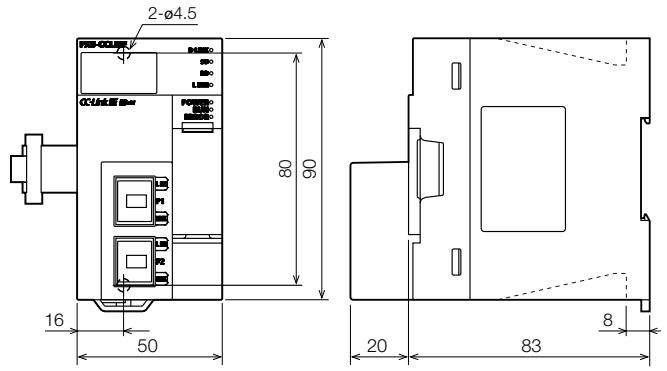

FX5-20PG-D

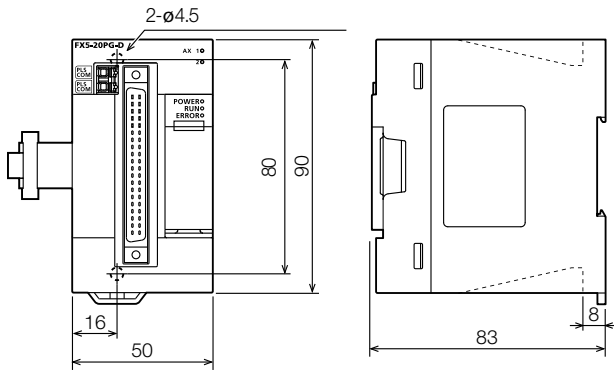

FX5-DP-M

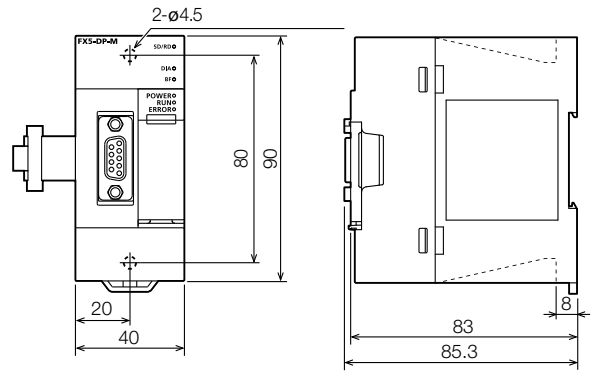

FX5-ENET,

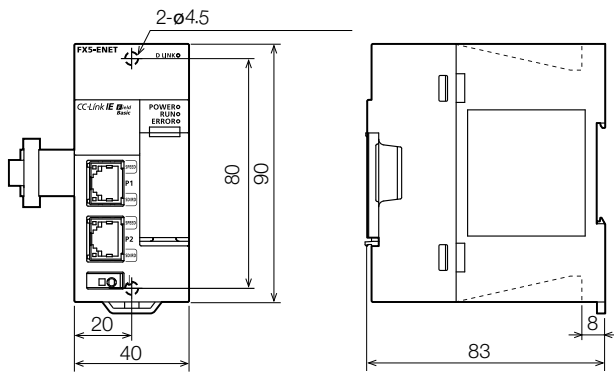

FX5-ENET/IP

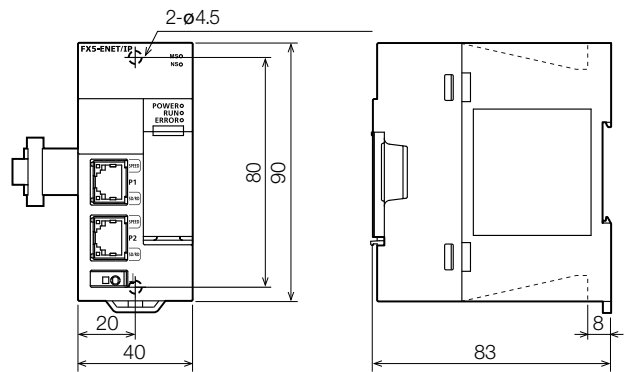

All dimensions in mm

Expansion adapters FX5

MELSEC-F series MELSEC iQ-F series

FX5-4AD-ADP/FX5-4DA-ADP
FX5-4AD-PT-ADP/FX5-4AD-TC-ADP

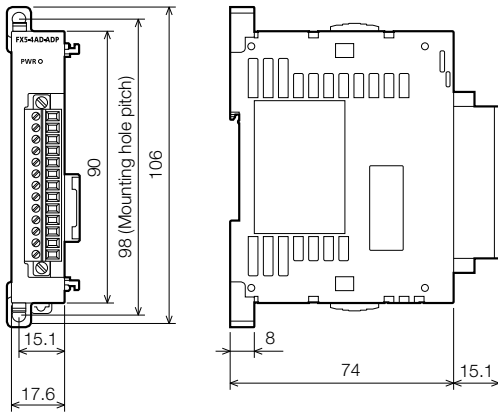

FX5-232ADP/FX5-485ADP

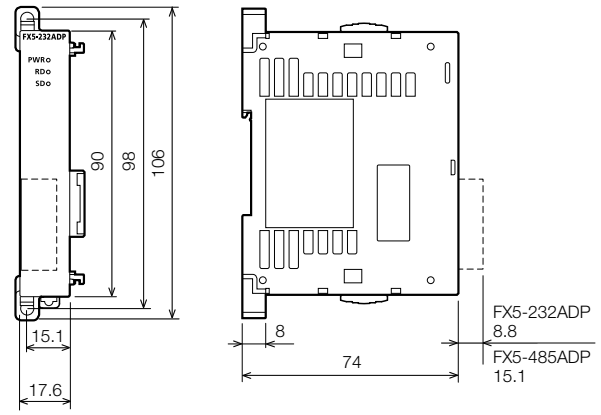

All dimensions in mm

Expansion boards FX5

MELSEC-F series MELSEC iQ-F series

FX5-232-BD

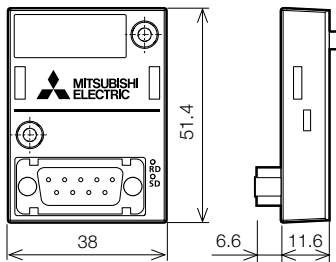

FX5-485-BD

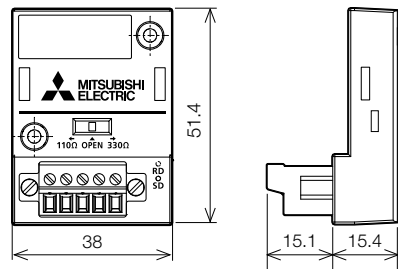

FX5-422-BD-GOT

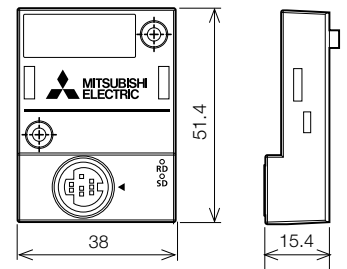

All dimensions in mm

Special function modules FX3U/FX3UC

MELSEC-F series MELSEC iQ-F series

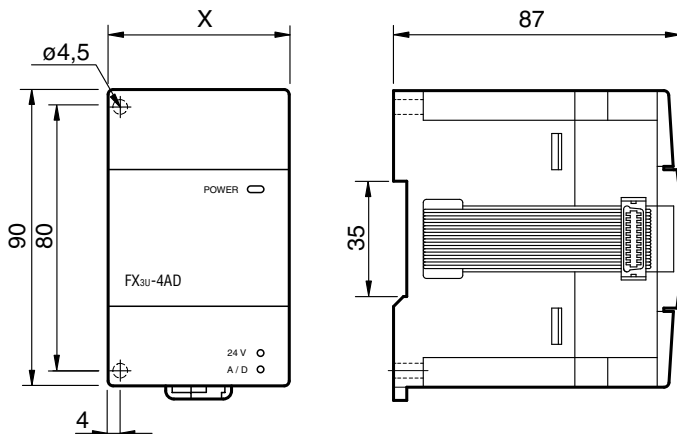

Type	X
FX3U-2HC	55
FX3U-3A-ADP	17.6
FX3U-4DA	55
FX3U-4AD	55
FX3U-4LC	90
FX3U-CF-ADP	45
FX3U-ENET	55
FX3U-CAN	43
FX3U-20SSC-H	55
FX3U-64CCL-M	55
FX3U-64DP-M	43
FX3U-1PSU-5V	55
FX3UC-4AD	20.2
FX3UC-1PS-5V	24.2
FX3U-1PG	43
FX3U-J1939	43

All dimensions in mm

Special function modules

Adapters FX3G

MELSEC-F series MELSEC iQ-F series

FX3G-485-BD

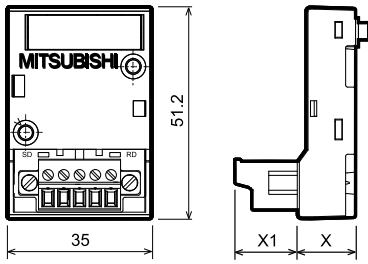

FX3G extension adapters

Type	X	X1
FX3G-1DA-BD	14.1	15.1
FX3G-232-BD	12	5.2
FX3G-2AD-BD	14.1	15.1
FX3G-422-BD	12	2.9
FX3G-485-BD	14.1	15.1
FX3G-8AV-BD	12	—

All dimensions in mm

Special function modules FX2N

MELSEC-F series MELSEC iQ-F series

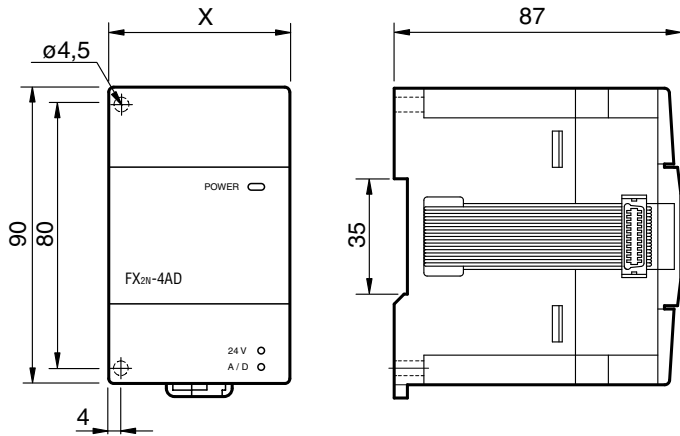

Type	X
FX2N-2DA	43
FX2N-2AD	43
FX2N-1HC	55
FX2N-10PG	43
FX2N-5A	55
FX2N-232-IF	55
FX2N-64DNET	43

FX2N-8AD

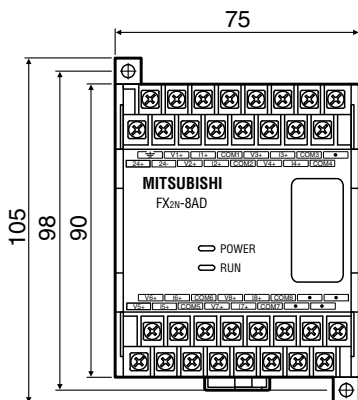

FX2N-32DP-IF-D

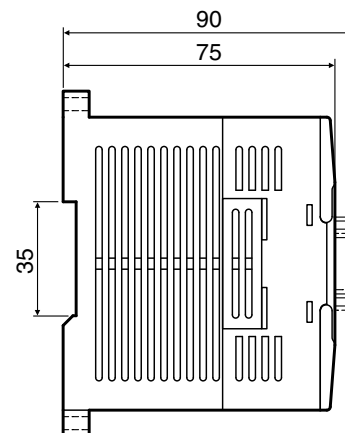
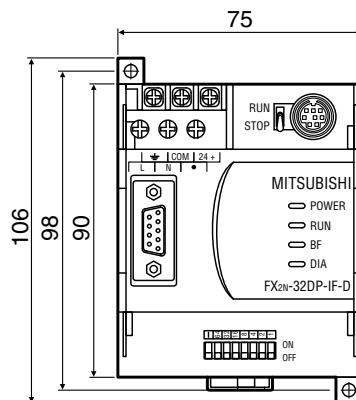

All dimensions in mm

Bus conversion modules FX5

MELSEC-F series MELSEC iQ-F series

FX5-CNV-BUS

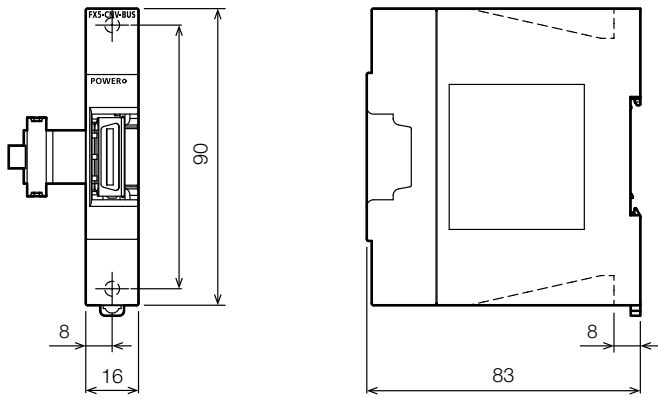

FX5-CNV-BUSC

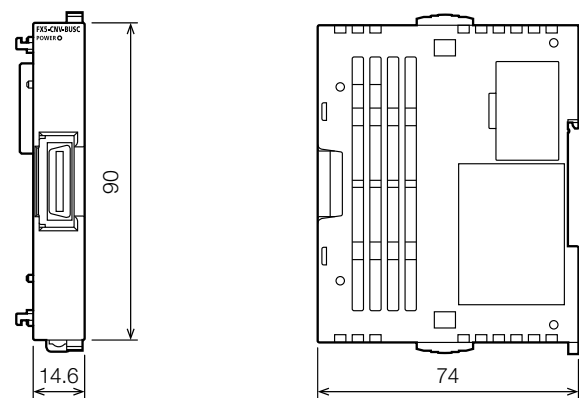

All dimensions in mm

Connector conversion modules FX5

MELSEC-F series MELSEC iQ-F series

FX5-CNV-IF

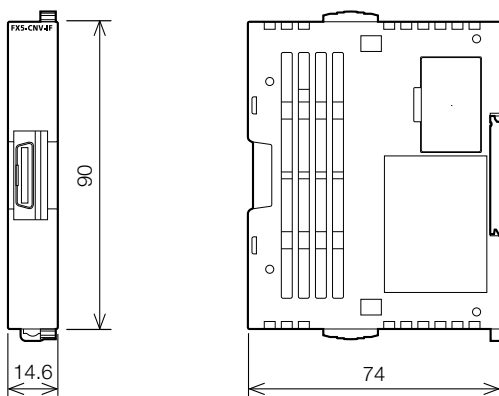

FX5-CNV-IFC

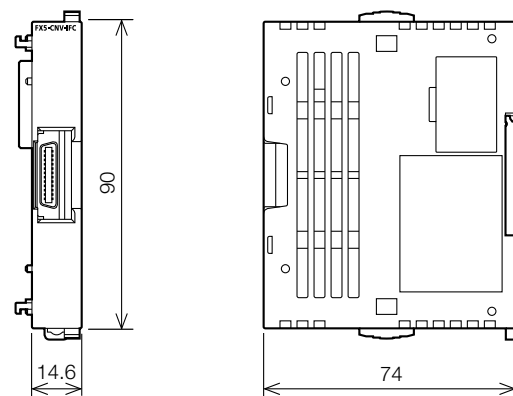

All dimensions in mm

Extension power supply modules FX5

MELSEC-F series MELSEC iQ-F series

FX5-1PSU-5V

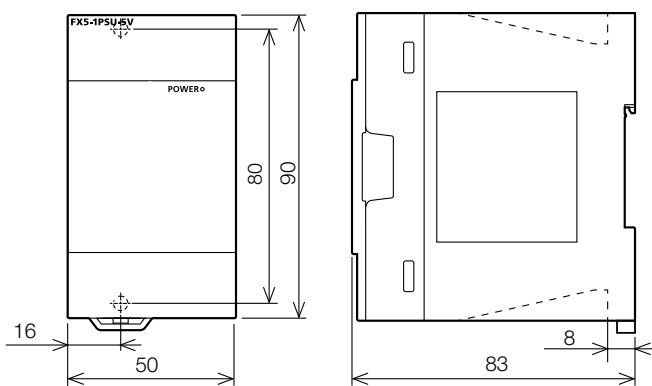

FX5-C1PS-5V

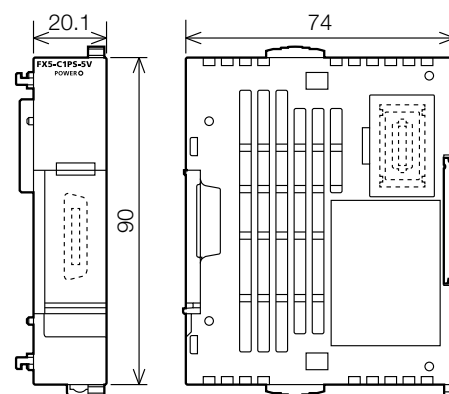

All dimensions in mm

Terminal blocks

MELSEC-F series MELSEC iQ-F series

TB-20-S

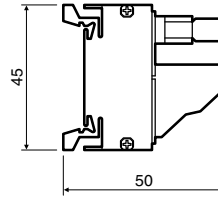
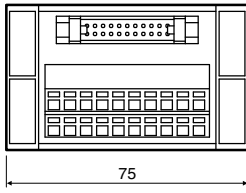

TB-20-C

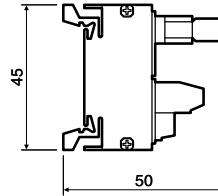
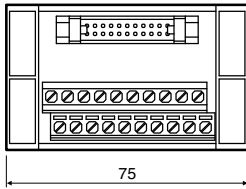

FX-16E-TB
FX-32E-TB

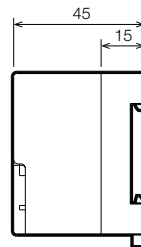
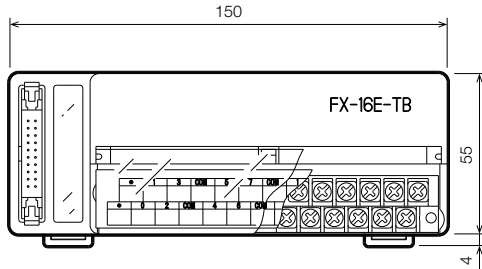

All dimensions in mm

Memory cassettes

MELSEC-F series MELSEC iQ-F series

FX3G-EEPROM-32L

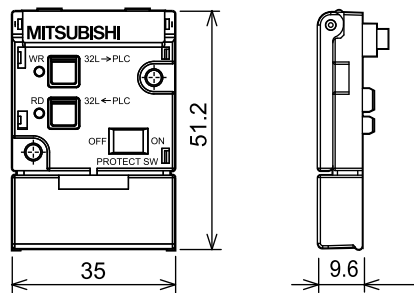

FX3U-FLROM-16/64/64L

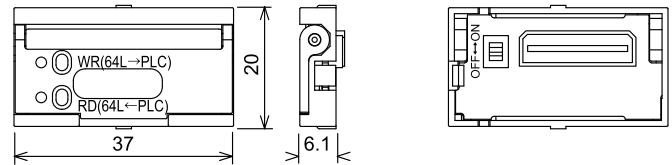

All dimensions in mm

Display panels

MELSEC-F series MELSEC iQ-F series

FX3S-5DM

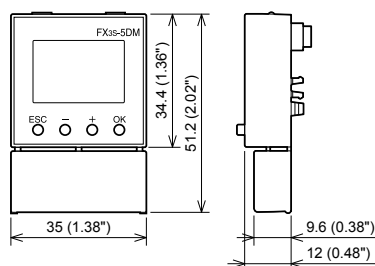

FX3U-7DM

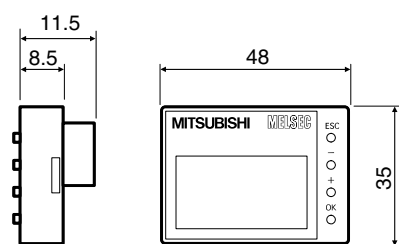

FX3G-5DM

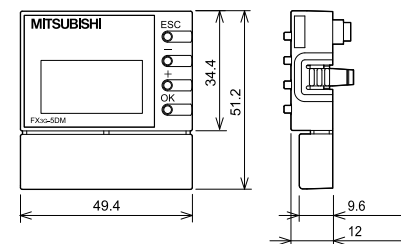

All dimensions in mm

ALPHA series

AL2-14M□□, AL2-24M□□

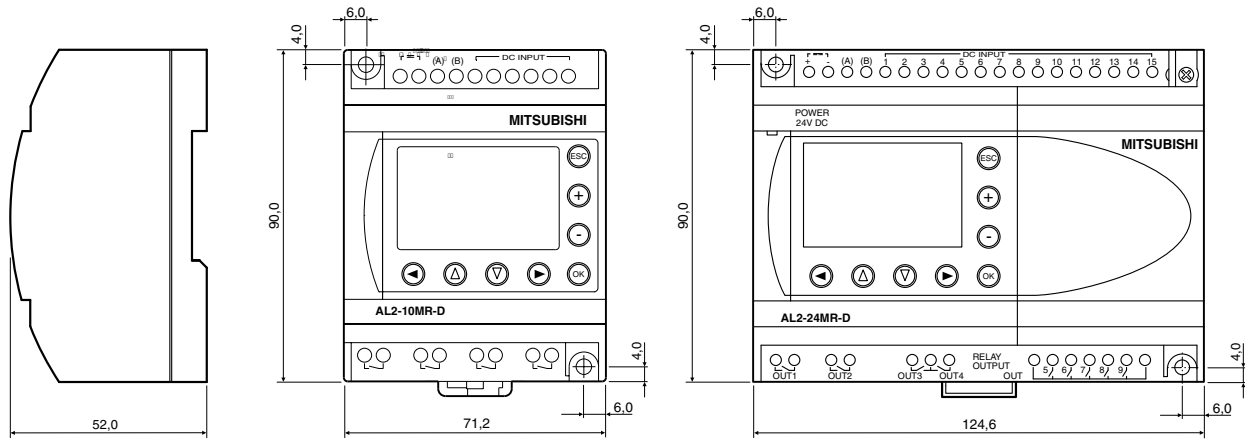

AL2-4EY□, AL2-2DA

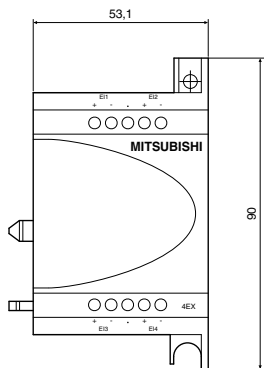

AL2-2PT-ADP, AL2-2TC-ADP

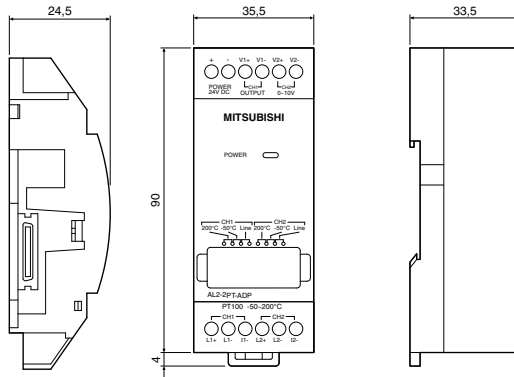

All dimensions in mm

MELSOFT – programming and documentation software for standard personal computers

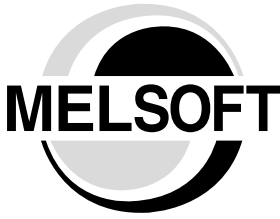

With the MELSOFT software family Mitsubishi Electric offers efficient software packages helping to reduce programming and setup times to a high degree. The MELSOFT software family provides instant access, direct communications, compatibility, and open exchange of variables.

The MELSOFT family comprises:

- Integrated engineering environment iQ Works2
- Programming packages AL-PCS/WIN and GX Works2/GX Works3

- Various development software for operator terminals (please refer to the technical catalogue HMI)
- Visualization software, such as MAPS
- Network configuration software, such as Configurator DP

■ ALPHA programming software

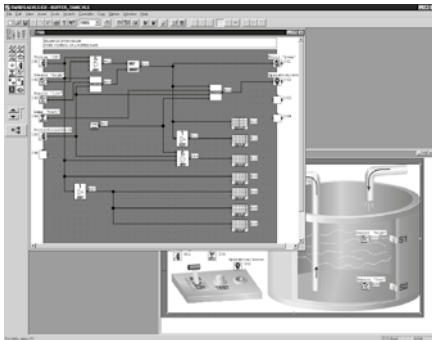

AL-PCS/WIN programming software

All controllers of the ALPHA series can be programmed with the MS Windows® software AL-PCS/WIN. Programming the ALPHA with this software is very easy and is done by placing the different program elements on a graphical programming environment. The connections (wiring) between the inputs, function blocks,

and outputs are drawn graphically by mouse click to build the logic. By this, programs with up to 200 function blocks can be created, where each single function in a program can be used as many times as desired.

A complete documentation of the program can be created directly from AL-PCS/WIN.

Software	(AL-PCS/WIN)
Series	Alpha series
Language	7 languages (English/German/French/Italian/Spanish/Swedish/Russian)
Applicable for	Windows 95/98/ME/NT/2000/XP/Vista/7
Order information	Free download from the webpage

Note: The AL-PCS/WIN software can be downloaded free of charge

PLC programming software

■ GX Works2/GX Works2 FX

FX3S FX3G FX3GC FX3GE FX3U FX3UC FX5U FX5UC

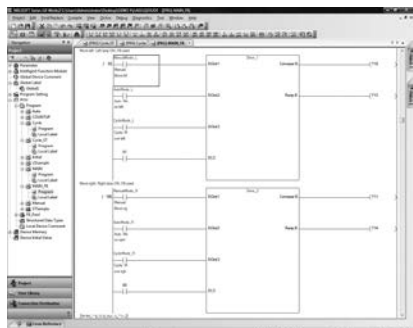

GX Works2 supports all PLC of the MELSEC System Q, L and FX3 series and offers numerous functions to facilitate programming work and support the user. GX Works2 FX has the same functionality as GX Works2 but just for FX3 PLC's.

The following programming languages are available:

- ST (Structured Text)
- LD (Ladder Diagram)
- FBD (Function Block Diagram)
- IL (Instruction List) – planned capability

Main features

- Integrated parameterization of special function modules (analog, temperature, positioning, counter, network)

- Use of program and function block libraries save time for programming and minimizes errors.
- Integrated simulation allows offline testing of the software and the configuration.
- Comprehensive diagnostics and debugging functions support the user in troubleshooting and fault clearance.
- Revision verification and restoration makes it possible to restore old program versions or to compare with programs from the PLC.
- GX Works2 is compatible with GX Developer and GX IEC Developer projects (as far as the editors are supported)

Software	Series	Language	Disk type	Art. no.
GX Works2 FX V01-2LOC-E	MELSEC FX3S, FX3G, FX3GC, FX3GE, FX3U, FX3UC	English	DVD	255804
GX Works2 FX V01-2LOC-E-INTRODUCTION				256745
GX Works2 V01-2LOC-E	All MELSEC PLCs (except MELSEC iQ-R/iQ-F)	English	DVD	234630
GX Works2 V01-5LOC-E				234631
GX Works2 V01-2LOC-E-UPGRADE				234632
GX Works2 V01-5LOC-E-UPGRADE				234634
GX Works2 V01-2LOC-E-INTRODUCTION				234789
GX Works2 V01-2LOC-G	All MELSEC PLCs (except MELSEC iQ-R/iQ-F)	German	DVD	244876
GX Works2 V01-5LOC-G				244877
GX Works2 V01-2LOC-G-INTRODUCTION				244878
Accessory	Programming cable FX-USB-AW			165288

■ GX Works3

FX3S FX3G FX3GC FX3GE FX3U FX3UC FX5U FX5UC

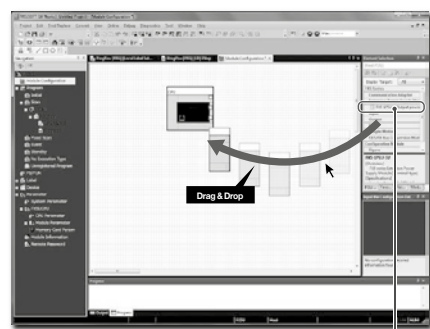

Simply drag & drop when adding a module

GX Works3 supports the MELSEC iQ-F (and iQ-R) series and offers numerous functions to facilitate programming work and support the user.

The main IEC languages are supported by GX Works3:

- ST (Structured Text)
- FBD (Function Block Diagram)
- LD (Ladder Diagram)

Main features

- Achieving an easy and intuitive programming by only making "selections" in a graphical environment with module configuration diagram and module label/module FB.

- Supporting various applications (parameter settings of simple motion module, creation of positioning data, parameter setting and servo adjustments of servo amplifier).
- Enabling transmitting/receiving of the data between an external device and the CPU module by matching the protocol of the external device (Communication protocol support function).

Software	Language	Disk type	Art. no.
GX Works3 V01-2LOC-E	English	DVD	284378
GX Works3 V01-5LOC-E	English	DVD	284379
GX Works3 V01-2LOC-E-UPGRADE	English	DVD	286219
GX Works3 V01-5LOC-E-UPGRADE	English	DVD	286220
GX Works3 V01-2LOC-G	German	DVD	304614
GX Works3 V01-5LOC-G	German	DVD	304645

■ Unified engineering environment: iQ Works

iQ Works integrates the functions necessary to manage every part of the system cycle.

System design

The intuitive system configuration diagram allows for the graphic assembly of systems, centralized management of disparate projects and batch configuration of the entire control system.

Programming

Use system labels to seamlessly share device data between GOTs, PLCs and motion controllers. Save the time and hassle of changing device values in each program by using the update system labels feature.

Test and startup

Debug and optimize programs using the simulation functions. Use the included diagnostics and monitoring functions to quickly identify the source of errors.

Operation and maintenance

Speed up the process of commissioning, configuring and updating the system by using the batch read feature. Virtually eliminate the confusion associated with system management.

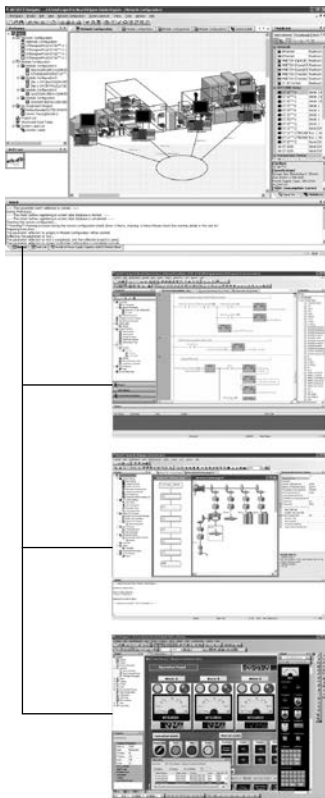

MELSOFT Navigator

is the heart of iQ Works. It enables the effortless design of entire upper-level systems and seamlessly integrates the other MELSOFT programs included with iQ Works. Functions such as system configuration design, batch parameter setting, system labels and batch read all help to reduce TCO.

MELSOFT GX Works

represents the next generation in MELSOFT PLC maintenance and programming software. Its functionality has been inherited from both GX and IEC Developer, with improvements made throughout to increase productivity and drive down engineering costs.

MELSOFT MT Works

is a comprehensive motion CPU maintenance and program design tool. Its many useful functions, such as intuitive settings, graphical programming and digital oscilloscope, simulator, different Motion OS support, assistance help, to reduce the MT Works2 associated with motion systems.

MELSOFT GT Works

is a complete HMI programming, screen creation and maintenance program. In order to reduce the labor required to create detailed and impressive applications, the software's functionality has been built around the concepts of ease of use, simplifications (without sacrificing functionality) and elegance (in design and screen graphics).

Software	Language	Disk type	Art. no.
iQ Works2 V01-2LOC-E	English	DVD	286227
iQ Works2 V01-5LOC-E	English	DVD	286228
iQ Works2 V01-2LOC-E-UPGRADE	English	DVD	286229
iQ Works2 V01-5LOC-E-UPGRADE	English	DVD	286230
iQ Works2 V01-2LOC-G	German	DVD	338821
iQ Works2 V01-5LOC-G	German	DVD	339022
iQ Works V02-2LOC-IT	Italian	DVD	401853
iQ Works V02-5LOC-IT	Italian	DVD	401854

Software for process visualisation and for dynamic data exchange

■ MX OPC Server

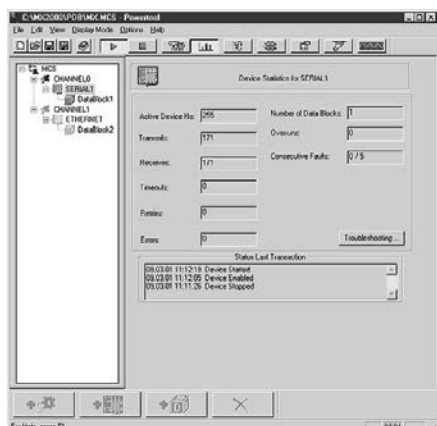

The OPC standard was developed for manufacturer independent communications between processes and Microsoft Windows® applications in client/server architecture.

OPC means “OLE for Process Control” and represents an application of the Microsoft DCOM technology (Distributed Component Object Model). In contrast to Active-X the OPC

based data exchange especially features a higher performance.

The MX OPC server is a standardized software interface that enables Microsoft Windows® applications to access a Mitsubishi Electric PLC quick and easily.

Software	MX OPC Server V0700-1LOC-E	MX OPC Server UA V0300-1LOC-E
Series	All MELSEC PLCs	
Language	English	
Disk type	CD ROM	
Order information	Art. no. 336237	336238

■ MX Components

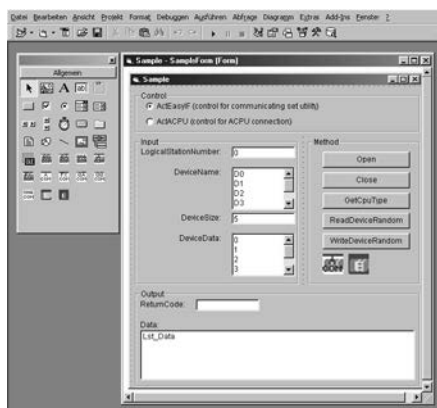

This software provides you with powerful Active-X elements. An internal driver manages the complete communications between your Microsoft Windows® application and your process. Via MX components and a programming language (e.g. Visual Basic, Visual C++, etc.) you can easily create your own PC applications or integrate existing PC applications.

Moreover, via MX Components and VBA the complete MS Office range is at your service. Without high effort you can integrate online process data of a Mitsubishi Electric PLC in your existing office software (e.g. MS Access or MS Excel etc.).

Software	MX Component V04-2LOC-E	MX Component V04-5LOC-E
Series	All MELSEC PLCs	
Language	English	
Disk type	CD ROM	
Order information	Art. no. 259728	259729

Software for Profibus networks

■ GX Configurator DP



The GX Configurator DP is a user friendly configurations software for the open network Profibus DP.

The software package is a 32 bit application and runs under all Windows versions.

Configuration of all Profibus DP modules for the MELSEC Ans/QnAS and A/Q series and also the FX family is possible.

Due to the supported extended user parameters of a GSD file, easy parameter setting of Profibus DP slave devices is possible even for third-party devices.

The new GX Configurator DP enables the download of all configuration data via an overriding network.

All Profibus modules are configured via the backside bus.

Software		GX Configurator DP V07-1L0C-M
Supported Profibus DP master modules for the Mitsubishi Electric MELSEC series		A1SJ71PB92D, AJ71PB92D, QJ71PB92D, FX3U-64DP
Language		English/German
Disk type		CD ROM
Order information	Art. no.	231731
Accessory		Programming cable FX-USB-AW, art. no.: 165288

Software for FX3U-20SSC-H

■ FX Configurator FP



FX Configurator-FP is beneficial for setting up table operation information, servo amplifier parameters and positioning parameters for the FX3U-SSC-H positioning module. Positioning operations and their associated parameters (speeds, addresses, torque limits etc.) can be monitored and tested with the integrated monitor and test functions.

Control patterns from simple to complicated combinations of positioning commands can easily be configured with new methods.

Software		FX Configurator FP V0100-1L0C-E
Supported modules for the Mitsubishi Electric MELSEC series		FX3U-20SSC-H
Language		English
Disk type		CD ROM
Order information	Art. no.	189283
Accessory		Programming cable FX-USB-AW, art. no.: 165288

MELSEC iQ-F series

Module type	CE		uL cUL	KC	Ship approvals							
	EMC	LVD*			ABS	DNV	LR	GL	BV	RINA	NK	KR
FX5U base units												
FX5U-32MR/DS	●	●	●	●	—	—	—	—	—	—	—	
FX5U-32MR/ES	●	●	●	●	●	●	●	●	●	●	●	
FX5U-32MT/DS	●	○	●	●	—	—	—	—	—	—	—	
FX5U-32MT/DSS	●	○	●	●	—	—	—	—	—	—	—	
FX5U-32MT/ES	●	●	●	●	●	●	●	●	●	●	●	
FX5U-32MT/ESS	●	●	●	●	●	●	●	●	●	●	●	
FX5U-64MR/DS	●	●	●	●	—	—	—	—	—	—	—	
FX5U-64MR/ES	●	●	●	●	●	●	●	●	●	●	●	
FX5U-64MT/DS	●	○	●	●	—	—	—	—	—	—	—	
FX5U-64MT/DSS	●	○	●	●	—	—	—	—	—	—	—	
FX5U-64MT/ES	●	●	●	●	●	●	●	●	●	●	●	
FX5U-64MT/ESS	●	●	●	●	●	●	●	●	●	●	●	
FX5U-80MR/DS	●	●	●	●	—	—	—	—	—	—	—	
FX5U-80MR/ES	●	●	●	●	●	●	●	●	●	●	●	
FX5U-80MT/DS	●	○	●	●	—	—	—	—	—	—	—	
FX5U-80MT/DSS	●	○	●	●	—	—	—	—	—	—	—	
FX5U-80MT/ES	●	●	●	●	●	●	●	●	●	●	●	
FX5U-80MT/ESS	●	●	●	●	●	●	●	●	●	●	●	
FX5UC base units												
FX5UC-32MT/D	●	○	●	●	●	●	●	●	●	●	●	
FX5UC-32MT/DS-TS	●	○	●	●	—	—	—	—	—	—	—	
FX5UC-32MT/DSS	●	○	●	●	●	●	●	●	●	●	●	
FX5UC-32MT/DSS-TS	●	○	●	●	—	—	—	—	—	—	—	
FX5UC-32MR/DS-TS	●	○	●	●	—	—	—	—	—	—	—	
FX5UC-64MT/D	●	○	●	●	●	●	●	●	●	●	●	
FX5UC-64MT/DSS	●	○	●	●	●	●	●	●	●	●	●	
FX5UC-96MT/D	●	○	●	●	●	●	●	●	●	●	●	
FX5UC-96MT/DSS	●	○	●	●	●	●	●	●	●	●	●	
FX5 I/O modules (extension cable type)												
FX5-8EX/ES	●	○	●	●	●	●	●	●	●	●	●	
FX5-8EYR/ES	●	●	●	●	●	●	●	●	●	●	●	
FX5-8EYT/ES	●	○	●	●	●	●	●	●	●	●	●	
FX5-8EYT/ESS	●	○	●	●	●	●	●	●	●	●	●	
FX5-16ER/ES	●	●	●	●	—	—	—	—	—	—	—	
FX5-16ET/ES	●	○	●	●	—	—	—	—	—	—	—	
FX5-16ET/ESS	●	○	●	●	—	—	—	—	—	—	—	
FX5-16EX/ES	●	○	●	●	●	●	●	●	●	●	●	
FX5-16EYR/ES	●	●	●	●	●	●	●	●	●	●	●	
FX5-16EYT/ES	●	○	●	●	●	●	●	●	●	●	●	
FX5-16EYT/ESS	●	○	●	●	●	●	●	●	●	●	●	
FX5-16ET/ES-H	●	○	●	●	●	●	●	●	●	●	●	
FX5-16ET/ESS-H	●	○	●	●	●	●	●	●	●	●	●	
FX5-32ER/ES	●	●	●	●	●	●	●	●	●	●	●	
FX5-32ET/ES	●	○	●	●	●	●	●	●	●	●	●	
FX5-32ET/ESS	●	○	●	●	●	●	●	●	●	●	●	
FX5-32ER/DS	●	●	●	●	—	—	—	—	—	—	—	
FX5-32ET/DS	●	○	●	●	—	—	—	—	—	—	—	
FX5-32ET/DSS	●	○	●	●	—	—	—	—	—	—	—	
FX5 I/O module (extension connector type)												
FX5-C16EX/D	●	○	●	●	●	●	●	●	●	●	●	
FX5-C16EX/DS	●	○	●	●	●	●	●	●	●	●	●	
FX5-C16EYT/D	●	○	●	●	●	●	●	●	●	●	●	
FX5-C16EYT/DSS	●	○	●	●	●	●	●	●	●	●	●	
FX5-C16EYR/D-TS ①	●	○	●	●	—	—	—	—	—	—	—	
FX5-C32EX/D	●	○	●	●	●	●	●	●	●	●	●	
FX5-C32EX/DS	●	○	●	●	●	●	●	●	●	●	●	
FX5-C32EX/DS-TS ①	●	○	●	●	—	—	—	—	—	—	—	
FX5-C32EYT/D	●	○	●	●	●	●	●	●	●	●	●	
FX5-C32EYT/D-TS ①	●	○	●	●	—	—	—	—	—	—	—	
FX5-C32EYT/DSS	●	○	●	●	●	●	●	●	●	●	●	
FX5-C32EYT/DSS-TS ①	●	○	●	●	—	—	—	—	—	—	—	
FX5-C32ET/D	●	○	●	●	●	●	●	●	●	●	●	
FX5-C32ET/DS-TS ①	●	○	●	●	—	—	—	—	—	—	—	
FX5-C32ET/DSS	●	○	●	●	●	●	●	●	●	●	●	
FX5-C32ET/DSS-TS ①	●	○	●	●	—	—	—	—	—	—	—	

Module type	CE		uL cUL	KC	Ship approvals							
	EMC	LVD*			ABS	DNV	LR	GL	BV	RINA	NK	KR
FX5 intelligent function module												
FX5-8AD	●	—	●	●	—	—	—	—	—	—	—	
FX5-4AD	●	—	●	●	—	—	—	—	—	—	—	
FX5-4DA	●	—	●	●	—	—	—	—	—	—	—	
FX5-4LC	●	—	●	●	—	—	—	—	—	—	—	
FX5-40SSC-S	●	—	●	●	—	—	—	—	—	—	—	
FX5-80SSC-S	●	—	●	●	—	—	—	—	—	—	—	
FX5-CCLIEF	●	○	●	●	—	—	—	—	—	—	—	
FX5-20PG-D	●	—	●	●	—	—	—	—	—	—	—	
FX5-20PG-P	●	—	●	●	—	—	—	—	—	—	—	
FX5-CCL-MS	●	—	● ^②	●	—	—	—	—	—	—	—	
FX5-ASL-M	●	—	●	●	—	—	—	—	—	—	—	
FX5-DP-M	●	—	●	●	—	—	—	—	—	—	—	
FX5-ENET	●	—	●	●	—	—	—	—	—	—	—	
FX5-ENET/IP	●	—	●	●	—	—	—	—	—	—	—	
FX5 extension power supply module												
FX5-1PSU-5V	●	●	●	●	●	●	●	●	●	●	●	
FX5-C1PS-5V	●	○	●	●	●	●	●	●	●	●	●	
FX5 bus conversion module												
FX5-CNV-BUS	●	○	●	●	●	●	●	●	●	●	●	
FX5-CNV-BUSC	●	○	●	●	●	●	●	●	●	●	●	
FX5 connector conversion module												
FX5-CNV-IF	●	○	●	●	●	●	●	●	●	●	●	
FX5-CNV-IFC	●	○	●	●	●	●	●	●	●	●	●	
FX5 expansion adapter												
FX5-4AD-ADP	●	○	●	●	●	●	●	●	●	●	●	
FX5-4AD-PT-ADP	●	○	●	●	—	—	—	—	—	—	—	
FX5-4AD-TC-ADP	●	○	●	●	—	—	—	—	—	—	—	
FX5-4DA-ADP	●	○	● ^③	●	●	●	●	●	●	●	●	
FX5-232ADP	●	○	●	●	●	●	●	●	●	●	●	
FX5-485ADP	●	○	●	●	●	●	●	●	●	●	●	
FX5U expansion board												
FX5-232-BD	●	○	—	●	●	●	●	●	●	●	●	
FX5-485-BD	●	○	—	●	●	●	●	●	●	●	●	
FX5-422-BD-GOT	●	○	—	●	●	●	●	●	●	●	●	
Terminal module												
FX-16E-TB	—	—	●	○	—	—	—	—	—	—	—	
FX-32E-TB	—	—	●	○	—	—	—	—	—	—	—	
FX-16EYR-TB	—	—	●	○	—	—	—	—	—	—	—	
FX-16EYS-TB	—	—	—	—	—	—	—	—	—	—	—	
FX-16EYT-TB	—	—	●	○	—	—	—	—	—	—	—	
FX-16E-TB/UL	—	—	●	○	—	—	—	—	—	—	—	
FX-32E-TB/UL	—	—	●	○	—	—	—	—	—	—	—	
FX-16EYR-ES-TB/UL	—	—	●	○	—	—	—	—	—	—	—	
FX-16EYS-ES-TB/UL	—	—	—	—	—	—	—	—	—	—	—	
FX-16EYT-ES-TB/UL	—	—	●	○	—	—	—	—	—	—	—	
FX-16EYT-ESS-TB/UL	—	—	●	○	—	—	—	—	—	—	—	
Extended extension cable												
FX5-30EC	●	○	●	●	—	—	—	—	—	—	—	
FX5-60EC	●	○	●	●	—	—	—	—	—	—	—	
Connector conversion adapter												
FX5-CNV-BC	●	○	●	●	●	●	●	●	●	●	●	
FX3 intelligent function module												
FX3U-4AD	●	○	●	●	—	—	—	—	—	—	—	
FX3U-4DA	●	○	●	●	—	—	—	—	—	—	—	
FX3U-4LC	●	○	●	●	—	—	—	—	—	—	—	
FX3U-1PG	●	○	●	●	—	—	—	—	—	—	—	
FX3U-2HC	●	○	●	●	—	—	—	—	—	—	—	
FX3U-16CCL-M	●	○	●	●	—	—	—	—	—	—	—	
FX3U-64CCL	●	○	●	●	—	—	—	—	—	—	—	
FX3U-128ASL-M	●	○	●	●	—	—	—	—	—	—	—	
FX3 extension power supply module												
FX3U-1PSU-5V	●	●	●	●	—	—	—	—	—	—	—	

① Spring clamp terminal block type
 ② Supported by manufacturing serial number 1760001 and later
 ③ Supported by manufacturing serial number 1660001 and later
 ● = comply, ○ = no need to comply
 *LVD = Low Voltage Directive

ALPHA and MELSEC-FX3 series

Module type	CE		uL cUL	KC	Ship approvals									
	EMC	LVD*			ABS	DNV	LR	GL	BV	RINA	NK	KR		
ALPHA 2 base units														
AL2-10MR-A	●	●	●	—	—	—	—	—	—	—	—	—		
AL2-10MR-D	●	●	●	—	—	—	—	—	—	—	—	—		
AL2-14MR-A	●	●	●	—	—	●	—	—	—	—	—	—		
AL2-14MR-D	●	●	●	—	—	●	—	—	—	—	—	—		
AL2-24MR-A	●	●	●	—	—	●	—	—	—	—	—	—		
AL2-24MR-D	●	●	●	—	—	●	—	—	—	—	—	—		
ALPHA extension modules														
AL2-2DA	●	●	●	—	—	—	—	—	—	—	—	—		
AL2-2PT-ADP	●	—	●	—	—	—	—	—	—	—	—	—		
AL2-2TC-ADP	●	—	●	—	—	—	—	—	—	—	—	—		
AL2-4EX-A2	●	●	●	—	—	●	—	—	—	—	—	—		
AL2-4EX	●	●	●	—	—	●	—	—	—	—	—	—		
AL2-4EYR	●	●	●	—	—	●	—	—	—	—	—	—		
AL2-4EYT	●	●	●	—	—	●	—	—	—	—	—	—		
FX3S base units														
FX3S-10MR/DS	●	○	●	●	●	●	●	●	●	—	●	—		
FX3S-10MR/ES	●	●	●	●	●	●	●	●	●	—	●	—		
FX3S-10MT/DS	●	○	●	●	●	●	●	●	●	—	●	—		
FX3S-10MT/DSS	●	○	●	●	●	●	●	●	●	—	●	—		
FX3S-10MT/ES	●	●	●	●	●	●	●	●	●	—	●	—		
FX3S-10MT/ESS	●	●	●	●	●	●	●	●	●	—	●	—		
FX3S-14MR/DS	●	○	●	●	●	●	●	●	●	—	●	—		
FX3S-14MR/ES	●	●	●	●	●	●	●	●	●	—	●	—		
FX3S-14MT/DS	●	○	●	●	●	●	●	●	●	—	●	—		
FX3S-14MT/DSS	●	○	●	●	●	●	●	●	●	—	●	—		
FX3S-14MT/ES	●	●	●	●	●	●	●	●	●	—	●	—		
FX3S-14MT/ESS	●	●	●	●	●	●	●	●	●	—	●	—		
FX3S-20MR/DS	●	○	●	●	●	●	●	●	●	—	●	—		
FX3S-20MR/ES	●	●	●	●	●	●	●	●	●	—	●	—		
FX3S-20MT/DS	●	○	●	●	●	●	●	●	●	—	●	—		
FX3S-20MT/DSS	●	○	●	●	●	●	●	●	●	—	●	—		
FX3S-20MT/ES	●	●	●	●	●	●	●	●	●	—	●	—		
FX3S-20MT/ESS	●	●	●	●	●	●	●	●	●	—	●	—		
FX3S-30MR/DS	●	○	●	●	●	●	●	●	●	—	●	—		
FX3S-30MR/ES	●	●	●	●	●	●	●	●	●	—	●	—		
FX3S-30MR/ES-2AD	●	●	●	●	●	●	●	●	●	—	●	—		
FX3S-30MT/DS	●	○	●	●	●	●	●	●	●	—	●	—		
FX3S-30MT/DSS	●	○	●	●	●	●	●	●	●	—	●	—		
FX3S-30MT/ES	●	●	●	●	●	●	●	●	●	—	●	—		
FX3S-30MT/ESS	●	●	●	●	●	●	●	●	●	—	●	—		
FX3S-30MT/ES-2AD	●	○	●	●	●	●	●	●	●	—	●	—		
FX3S-30MT/ESS	●	●	●	●	●	●	●	●	●	—	●	—		
FX3S-30MT/ESS-2AD	●	○	●	●	●	●	●	●	●	—	●	—		
FX3G base units														
FX3G-14MR/DS	●	●	●	●	●	●	●	●	●	●	—	—		
FX3G-14MR/ES	●	●	●	●	●	●	●	●	●	●	—	—		
FX3G-14MT/DSS	●	○	●	●	●	●	●	●	●	●	—	—		
FX3G-14MT/ESS	●	●	●	●	●	●	●	●	●	●	—	—		
FX3G-24MR/DS	●	●	●	●	●	●	●	●	●	●	—	—		
FX3G-24MR/ES	●	●	●	●	●	●	●	●	●	●	—	—		
FX3G-24MT/DSS	●	○	●	●	●	●	●	●	●	●	—	—		
FX3G-24MT/ESS	●	●	●	●	●	●	●	●	●	●	—	—		
FX3G-40MR/DS	●	●	●	●	●	●	●	●	●	●	—	—		
FX3G-40MR/ES	●	●	●	●	●	●	●	●	●	●	—	—		
FX3G-40MT/DSS	●	○	●	●	●	●	●	●	●	●	—	—		
FX3G-40MT/ESS	●	●	●	●	●	●	●	●	●	●	—	—		
FX3G-60MR/DS	●	●	●	●	●	●	●	●	●	●	—	—		
FX3G-60MR/ES	●	●	●	●	●	●	●	●	●	●	—	—		
FX3G-60MT/DSS	●	○	●	●	●	●	●	●	●	●	—	—		
FX3G-60MT/ESS	●	●	●	●	●	●	●	●	●	●	—	—		

Module type	CE		uL cUL	KC	Ship approvals									
	EMC	LVD*			ABS	DNV	LR	GL	BV	RINA	NK	KR		
FX3GE base units														
FX3GE-24MR/DS	●	●	●	—	—	—	—	—	—	—	—	—		
FX3GE-24MR/ES	●	●	●	—	—	—	—	—	—	—	—	—		
FX3GE-24MT/DS	●	○	●	—	—	—	—	—	—	—	—	—		
FX3GE-24MT/DSS	●	○	●	—	—	—	—	—	—	—	—	—		
FX3GE-24MT/ES	●	●	●	—	—	—	—	—	—	—	—	—		
FX3GE-24MT/ESS	●	●	●	—	—	—	—	—	—	—	—	—		
FX3GE-40MR/DS	●	●	●	—	—	—	—	—	—	—	—	—		
FX3GE-40MR/ES	●	●	●	—	—	—	—	—	—	—	—	—		
FX3GE-40MT/DS	●	○	●	—	—	—	—	—	—	—	—	—		
FX3GE-40MT/DSS	●	○	●	—	—	—	—	—	—	—	—	—		
FX3GE-40MT/ES	●	●	●	—	—	—	—	—	—	—	—	—		
FX3GE-40MT/ESS	●	●	●	—	—	—	—	—	—	—	—	—		
FX3GC base units														
FX3GC-32MT/D	●	○	●	●	—	—	—	—	—	—	—	—		
FX3GC-32MT/DSS	●	○	●	●	—	—	—	—	—	—	—	—		
FX3U base units														
FX3U-16MR/DS	●	●	●	●	●	●	●	●	●	●	●	●		
FX3U-16MR/ES	●	●	●	●	●	●	●	●	●	●	●	●		
FX3U-16MT/DSS	●	○	●	●	●	●	●	●	●	●	●	●		
FX3U-16MT/ESS	●	●	●	●	●	●	●	●	●	●	●	●		
FX3U-32MR/DS	●	●	●	●	●	●	●	●	●	●	●	●		
FX3U-32MR/ES	●	●	●	●	●	●	●	●	●	●	●	●		
FX3U-32MT/DSS	●	○	●	●	●	●	●	●	●	●	●	●		
FX3U-32MT/ESS	●	●	●	●	●	●	●	●	●	●	●	●		
FX3U-48MR/DS	●	●	●	●	●	●	●	●	●	●	●	●		
FX3U-48MR/ES	●	●	●	●	●	●	●	●	●	●	●	●		
FX3U-48MT/DSS	●	○	●	●	●	●	●	●	●	●	●	●		
FX3U-48MT/ESS	●	●	●	●	●	●	●	●	●	●	●	●		
FX3U-64MR/DS	●	●	●	●	●	●	●	●	●	●	●	●		
FX3U-64MR/ES	●	●	●	●	●	●	●	●	●	●	●	●		
FX3U-64MT/DSS	●	○	●	●	●	●	●	●	●	●	●	●		
FX3U-64MT/ESS	●	●	●	●	●	●	●	●	●	●	●	●		
FX3U-80MR/DS	●	●	●	●	●	●	●	●	●	●	●	●		
FX3U-80MR/ES	●	●	●	●	●	●	●	●	●	●	●	●		
FX3U-80MT/DSS	●	○	●	●	●	●	●	●	●	●	●	●		
FX3U-80MT/ESS	●	●	●	●	●	●	●	●	●	●	●	●		
FX3U-128MR/ES	●	●	●	●	●	●	●	●	●	●	●	●		
FX3U-128MT/ESS	●	●	●	●	●	●	●	●	●	●	●	●		
FX3UC base units														
FX3UC-16MT/DSS	●	○	●	●	●	●	●	●	●	●	—	—		
FX3UC-32MT/DSS	●	○	●	●	●	●	●	●	●	●	—	—		
FX3UC-64MT/DSS	●	○	●	●	●	●	●	●	●	●	—	—		
FX3UC-96MT/DSS	●	○	●	●	●	●	●	●	●	●	—	—		

● = comply, ○ = no need to comply
 *LVD = Low Voltage Directive

Module type	CE		uL cUL	KC	Ship approvals									
	EMC	LVD*			ABS	DNV	LR	GL	BV	RINA	NK	KR		
FX2N extension units														
FX2N-32ER-ES/UL	●	●	●	●	●	●	●	●	●	●	●	●	●	●
FX2N-32ET-ESS/UL	●	●	●	●	●	●	●	●	●	●	●	●	●	●
FX2N-48ER-DS	●	●	●	●	●	●	—	—	—	—	—	—	●	●
FX2N-48ER-ES/UL	●	●	●	●	●	●	●	●	●	●	●	●	●	●
FX2N-48ET-DSS	●	○	●	●	●	●	—	—	—	●	—	—	●	●
FX2N-48ET-ESS/UL	●	●	●	●	●	●	●	●	●	●	●	—	●	●
FX2N extension blocks														
FX2N-8ER-ES/UL	●	●	●	○	—	●	—	●	—	—	—	—	—	—
FX2N-8ET-ES/UL	●	●	●	○	—	●	—	●	—	—	—	—	—	—
FX2N-8EYR-ES/UL	●	●	●	○	—	●	—	●	—	—	—	—	—	—
FX2N-8EYT-ESS/UL	●	●	●	○	—	●	—	●	—	—	—	—	—	—
FX2N-16EX-ES/UL	●	○	●	○	●	●	●	●	●	●	●	●	●	●
FX2N-16EYR-ES/UL	●	○	●	○	●	●	●	●	●	●	●	●	●	●
FX2N-16EYT-ESS/UL	●	○	●	○	●	●	●	●	●	●	●	●	●	●
FX2N special function modules														
FX2N-1HC	●	○	●	●	●	●	●	●	●	●	—	—	●	●
FX2N-2AD	●	○	●	●	●	—	—	●	—	—	●	—	●	●
FX2N-2DA	●	○	●	●	●	—	—	●	—	—	●	—	●	●
FX2N-5A	●	○	●	●	—	—	—	●	●	●	—	—	—	—
FX2N-8AD	●	○	●	●	—	—	—	●	●	●	—	—	—	—
FX2N-10PG	●	○	●	●	—	—	—	—	—	—	—	—	—	—
FX2N-32CCL	●	○	—	●	—	—	—	—	—	—	—	—	—	—
FX2N-32DP-IF-D	●	○	—	●	—	—	—	—	—	—	—	—	—	—
FX2N-64DNET	●	○	●	●	—	—	—	—	—	—	—	—	—	—
FX2N-232IF	●	○	—	●	●	●	●	●	●	●	—	—	—	—
FX2NC extension blocks														
FX2NC-16EX-DS	●	○	●	○	●	●	●	—	—	—	—	—	—	—
FX2NC-16EX-T-DS	●	○	●	○	●	●	●	—	—	—	—	—	—	—
FX2NC-16EYR-T-DS	●	●	●	○	●	●	●	—	—	—	—	—	—	—
FX2NC-16EYT-DSS	●	○	●	○	●	●	●	—	—	—	—	—	—	—
FX2NC-32-EX-DS	●	○	●	○	●	●	●	—	—	—	—	—	—	—
FX2NC special function modules														
FX2NC-1HC	●	●	●	●	—	—	—	—	—	—	—	—	—	—
FX3U special function modules														
FX3U-2HC	●	○	●	●	—	—	—	—	—	—	—	—	—	—
FX3U-2HSY-ADP	●	○	●	●	●	●	●	●	●	●	●	●	●	●
FX3U-3A-ADP	●	○	●	●	—	—	—	—	—	—	—	—	—	—
FX3U-4AD	●	○	●	●	—	—	—	—	—	—	—	—	—	—
FX3U-4AD-ADP	●	○	●	●	●	●	●	●	●	●	●	●	●	●
FX3U-4AD-PNK-ADP	●	○	●	●	—	—	—	—	—	—	—	—	—	—
FX3U-4AD-PT-ADP	●	○	●	●	●	●	●	●	●	●	●	●	●	●
FX3U-4AD-PTW-ADP	●	○	●	●	—	—	—	—	—	—	—	—	—	—
FX3U-4AD-TC-ADP	●	○	●	●	●	●	●	●	●	●	●	●	●	●
FX3U-4DA	●	○	●	●	—	—	—	—	—	—	—	—	—	—
FX3U-4DA-ADP	●	○	●	●	●	●	●	●	●	●	●	●	●	●
FX3U-4HSX-ADP	●	○	●	●	●	●	●	●	●	●	●	●	●	●
FX3U-4LC	●	○	●	●	—	—	—	—	—	—	—	—	—	—
FX3U-20SSC-H	●	○	●	●	—	—	—	—	—	—	—	—	—	—
FX3U-232ADP-MB	●	○	●	●	●	●	●	●	●	●	●	●	●	●
FX3U-485ADP-MB	●	○	●	●	●	●	●	●	●	●	●	●	●	●
FX3U-CF-ADP	●	○	●	●	—	—	—	—	—	—	—	—	—	—
FX3U-ENET-ADP	●	○	●	●	—	—	—	—	—	—	—	—	—	—
FX3U-ENET	●	○	●	●	●	●	●	●	—	—	—	—	—	—
FX3U-CAN	●	○	●	—	●	●	●	●	●	●	—	—	—	—
FX3U-16CCL-M	●	○	●	●	—	—	—	—	—	—	—	—	—	—
FX3U-64CCL	●	○	●	●	—	—	—	—	—	—	—	—	—	—
FX3U-64DP-M	●	○	●	—	●	●	—	●	—	—	—	—	—	—
FX3U-J1939	●	○	●	—	●	●	●	●	●	●	●	●	●	●
FX3U-1PG	●	○	●	●	—	—	—	—	—	—	—	—	—	—
FX3G interface adapter														
FX3G-CNV-ADP	●	○	●	○	●	●	●	●	●	●	●	●	●	—
FX3S interface adapter														
FX3S-CNV-ADP	●	○	●	○	—	—	—	—	—	—	—	—	—	—

Module type	CE		uL cUL	KC	Ship approvals									
	EMC	LVD*			ABS	DNV	LR	GL	BV	RINA	NK	KR		
FX3UC special function blocks														
FX3UC-1PS-5V	●	○	●	●	●	●	●	●	●	●	●	—	—	—
FX3UC-4AD	●	○	●	●	—	—	—	—	—	—	—	—	—	—
Adapter boards														
FX3G-1DA-BD	●	○	—	●	●	●	●	●	●	●	●	●	●	—
FX3G-2AD-BD	●	○	—	●	●	●	●	●	●	●	●	●	●	—
FX3G-8AV-BD	●	○	—	○	●	●	●	●	●	●	●	●	●	—
FX3G-232-BD	●	○	—	●	●	●	●	●	●	●	●	●	●	—
FX3G-422-BD	●	○	—	○	●	●	●	●	●	●	●	●	●	—
FX3G-485-BD	●	○	—	○	●	●	●	●	●	●	●	●	●	—
FX3U-232-BD	●	○	—	●	●	●	●	●	●	●	●	●	●	●
FX3U-422-BD	●	○	—	●	●	●	●	●	●	●	●	●	●	●
FX3U-485-BD	●	○	—	●	●	●	●	●	●	●	●	●	●	●
FX3U-CNV-BD	●	○	—	○	●	●	●	●	●	●	●	●	●	●
FX3U-USB-BD	●	○	—	●	●	●	●	●	●	●	●	●	●	●
FX3G-CNV-ADP	●	○	●	○	●	●	●	●	●	●	●	●	●	●
FX3G-CNV-ADP	●	○	●	○	●	●	●	●	●	●	●	—	●	—
Accessories														
ALPHA POWER 24	●	●	●	—	—	—	—	—	—	—	—	—	—	—
FX-232AWC-H	●	○	—	●	—	—	—	—	—	—	—	—	—	—
FX-USB-AW	●	○	—	●	—	—	—	—	—	—	—	—	—	—
FX2NC-CNV-BC	●	○	—	○	—	—	—	—	—	—	—	—	—	—
FX2NC-CNV-IF	●	○	—	—	—	—	—	●	—	—	—	—	—	—
FX3G-5DM	●	○	—	●	●	●	●	●	●	●	●	●	●	—
FX3U-1PSU-5V	●	●	●	—	—	—	—	—	—	—	—	—	—	—
FX3U-32BL	—	—	—	—	—	—	—	—	—	—	—	—	—	—
FX3U-7DM	●	○	—	●	●	●	●	●	●	●	●	●	●	●
FX3U-7DM-HLD	—	○	—	○	—	—	—	—	—	—	—	—	—	—
FX3UC-1PS-5V	—	—	—	—	—	—	—	●	—	—	—	—	—	—
Memory cassettes														
FX3G-EEPROM-32L	●	○	—	○	●	●	●	●	●	●	●	●	●	—
FX3U-FLROM-16	●	○	—	○	●	●	●	●	●	●	●	●	●	●
FX3U-FLROM-64	●	○	—	○	●	●	●	●	●	●	●	●	●	●
FX3U-FLROM-64L	●	○	—	○	●	●	●	●	●	●	●	●	●	●

● = comply, ○ = no need to comply
 *LVD = Low Voltage Directive

M

MELSEC-F series

- Accessories 79
- Analog modules 59
- Certifications 110
- Communication modules 72
- Configuration
 - FX3G 14
 - FX3GC 16
 - FX3GE 14
 - FX3S 16
 - FX3U 12
 - FX3UC 12
- Data logger module 63
- Dimensions 92
- Extension adapters 76
- High-speed counter adapters 64
- High-speed counter modules 63
- Interface adapters 78
- I/O extension 53
 - Powered extension units 53
 - Unpowered extension modules 55
- Network modules 66
- Positioning modules 64
- Product overview 5
- Software 105
- Special functions
 - FX control solutions 29
- Specifications
 - FX3G 45
 - FX3GC 45
 - FX3GE 45
 - FX3S 38
 - FX3U 49
 - FX3UC 52
- Temperature control modules 62
- Unit components
 - FX3G 39
 - FX3GC 43
 - FX3GE 41
 - FX3S 36
 - FX3U 46
 - FX3UC 50

MELSEC iQ-F series

- Accessories 79
- Analog modules 59
- Base units
 - FX5U 31
 - FX5UC 34
- Certifications 109
- Communication modules 72
- Configuration
 - FX5U 8
 - FX5UC 10
- Dimensions 91
- High-speed counter modules 63
- Interface adapters 78
- I/O extension 54
 - Powered extension units 54
 - Unpowered extension modules 56
- Network modules 66
- Positioning modules 64
- Product overview 4
- Simple Motion modules 65
- Software 105
- Special functions
 - Advanced motion control 28
 - Basic positioning control 27
 - Battery-less and maintenance-free 25
 - Built-in analog inputs/outputs (with alarm output) 20
 - Built-in Ethernet port 19
 - Built-in positioning (200 kpps, 4 axes built in) + Positioning 2 axes (200 kpps, 2 axes) 26
 - Built-in RS485 port (with Modbus® function) 20
 - Built-in SD card slot 20
 - Data backup/restoration function 23
 - Data logging 24
 - Event history function 22
 - FTP server function 24
 - High-speed system bus communication 19
 - Intuitive programming environment 25
 - IP filter function 23
 - Memory dump function 22
 - Modbus®/TCP 21
 - Parallel link function 23
 - Real-time monitoring 21
 - Security functions 24
 - Simple Motion modules (4-axis/8-axis control modules) 27
 - SNTP client (Time setting function) 22
 - Webserver 21
- Specifications
 - FX5U 32
 - FX5UC 35
- Temperature control modules 62
- Unit components
 - FX5U 30
 - FX5UC 33

P

Programming

- ALPHA programming software 104
- iQ Works 106
- MELSOFT – programming and documentation software for standard personal computers 104
- PLC programming software 105
 - GX Works2/GX Works2 FX 105
 - GX Works3 105
- Software for FX3U-20SSC-H 108
 - FX Configurator FP 108
- Software for Profibus networks 108
 - GX Configurator DP 108
- Visualisation software 107
 - MX Components 107
 - MX OPC Server 107

S

System description FX series

- Calculation of the power consumption 18
- Components FX PLC 7
- Configuration 12
- Product overview 4
- Selection guide 6

T

The ALPHA 2 series

- Accessories 90
- Base units 87
- Certifications 110
- Dimensions 103
- Extension modules 89
- Software 104
- Specifications 88
- Unit components 86

Your solution partner

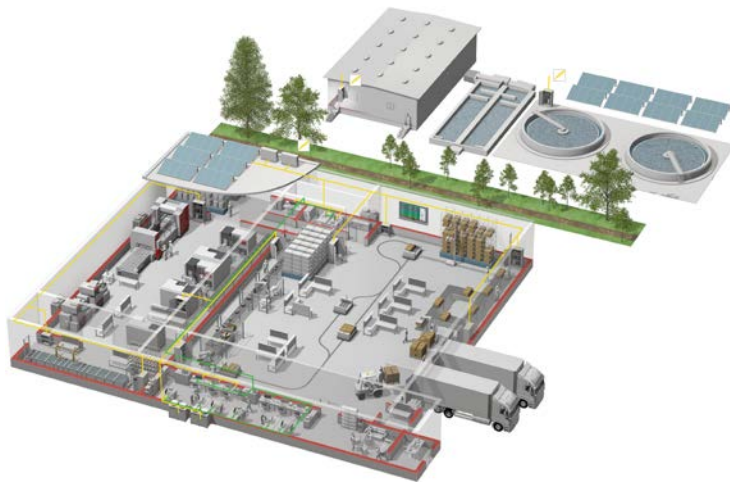

Mitsubishi Electric offers a wide range of automation equipment from PLCs and HMIs to CNC and EDM machines

A name to trust

Since its beginnings in 1870, some 45 companies use the Mitsubishi name, covering a spectrum of finance, commerce and industry.

The Mitsubishi brand name is recognized around the world as a symbol of premium quality.

Mitsubishi Electric Corporation is active in space development, transportation, semi-conductors, energy systems, communications and information processing, audio visual equipment and home electronics, building and energy management and automation systems, and has 237 factories and laboratories worldwide in over 121 countries.

This is why you can rely on Mitsubishi Electric automation solution - because we know first hand about the need for reliable, efficient, easy-to-use automation and control in our own factories.

As one of the world's leading companies with a global turnover of over 4 trillion Yen (over \$40 billion), employing over 130,000 people, Mitsubishi Electric has the resource and the commitment to deliver the ultimate in service and support as well as the best products.



Low voltage: MCCB, MCB, ACB



Medium voltage: VCB, VCC



Power monitoring, energy management



Compact and modular controllers



Inverters, servos and motors



Visualization: HMIs, software, MES connectivity



Numerical control (NC)



Robots: SCARA, articulated arm



Processing machines: EDM, lasers, IDS



Air-conditioning, photovoltaic, EDS

Global Partner. Local Friend.

European Offices

Germany Mitsubishi Electric Europe B.V. Mitsubishi-Electric-Platz 1 D-40882 Ratingen Phone: +49 (0)2102 / 486-0	Czech Rep. Mitsubishi Electric Europe B.V. Pekařská 621/7 CZ-115 00 Praha 5 Phone: +420 255 719 200	France Mitsubishi Electric Europe B.V. 25, Boulevard des Bouvets F-92741 Nanterre Cedex Phone: +33 (0)1 / 55 68 55 68	Ireland Mitsubishi Electric Europe B.V. Westgate Business Park, Ballymount JRL-Dublin 24 Phone: +353 (0)1 4198800	Italy Mitsubishi Electric Europe B.V. Viale Colonna 7 Palazzo Saio I-20864 Agrate Brianza (MB) Phone: +39 039 / 60 53 1	Netherlands Mitsubishi Electric Europe B.V. Nijverheidsweg 23C NL-3641 RP Mijdrecht Phone: +31 (0) 297 250 350	Poland Mitsubishi Electric Europe B.V. ul. Krakowska 48 PL-32-083 Balice Phone: +48 (0) 12 347 65 00
Russia Mitsubishi Electric (Russia) LLC 2 bld. 1, Letnikovskaya st. RU-115114 Moscow Phone: +7 495 / 721 2070	Spain Mitsubishi Electric Europe B.V. Carretera de Rubí 76-80 Apdo. 420 E-08190 Sant Cugat del Vallés (Barcelona) Phone: +34 (0) 93 / 5653131	Sweden Mitsubishi Electric Europe B.V. (Scandinavia) Hedvig Möllers gata 6 SE-223 55 Lund Phone: +46 (0) 8 625 10 00	Turkey Mitsubishi Electric Turkey Elektrik Ürünleri A.Ş. Serfali Mahallesi Kale Sokak No:41 TR-34775 Ümraniye-İSTANBUL Phone: +90 (216) 969 25 00	UK Mitsubishi Electric Europe B.V. Travellers Lane UK-Hatfield, Herts. AL10 8XB Phone: +44 (0)1707 / 28 87 80		

Representatives

Austria GEVA Wiener Straße 89 A-2500 Baden Phone: +43 (0)2252 / 85 55 20	Belarus OOO TECHNIKON Prospect Nezavisimosti 177-9 BY-220125 Minsk Phone: +375 (0)17 / 393 1177	Bosnia and Herzegovina INEA RBT d.o.o. Stegne 11 SI-1000 Ljubljana Phone: +386 (0)1 / 513 8116	Bulgaria AKHNATON 4, Andrei Ljapchev Blvd., PO Box 21 BG-1756 Sofia Phone: +359 (0)2 / 817 6000	Croatia INEA CR Losinjka 4 a HR-10000 Zagreb Phone: +385 (0)1 / 36 940 -01/-02/-03	Czech Republic AutoCont C.S. S.R.O. Kaňkova 1553/3 CZ-702 00 Ostrava 2 Phone: +420 595 691 150	Denmark HANS FØLSGAARD A/S Theigaards Torv 1 DK-4600 Køge Phone: +45 4320 8600
Estonia Electrobit OÜ Pärnu mnt. 100i EST-11317, Tallinn Phone: +372 6518 140	Finland UTU Automation Oy Pellontie 37 FIN-28400 Ulvila Phone: +358 (0)207 / 463 500	Greece UTEKO A.B.E.E. 5, Marogerous Str. GR-18542 Piraeus Phone: +30 (0)211 / 1206-900	Hungary MELTRADE Kft. Fertő utca 14, HU-1107 Budapest Phone: +36 (0)1 / 431-9726	Kazakhstan TOO Kazpromavtomatika Ul. Zhambyla 25 KAZ-100017 Karaganda Phone: +7 7212 / 50 10 00	Latvia OAK Integrator Products SIA Rītausmas iela 23 LV-1058 Rīga Phone: +371 67842280	Lithuania Automatikos Centras, UAB Neries krantinė 14A-101 LT-48397 Kaunas Phone: +370 37 262707
Malta ALFATRADE Ltd. 99, Paola Hill Malta-Paola PLA 1702 Phone: +356 (0)21 / 697 816	Moldova INTEHSIS SRL bld. Traian 23/1 MD-2060 Kishinev Phone: +373 (0)22 / 66 4242	Portugal Fonseca S.A. R. João Francisco do Casal 87/89 PT-3801-997 Aveiro, Esgueira Phone: +351 (0)234 / 303 900	Romania Sirius Trading & Services Aleea Lacul Morii Nr. 3 RO-060841 Bucuresti, Sector 6 Phone: +40 (0)21 / 430 40 06	Serbia INEA SR d.o.o. Ul. Karadjordjeva 12/217 SR-11300 Smederevo Phone: +381 69 172 27 25	Slovakia SIMAP SK Dolná Pažba 603/97 SK-911 06 Trenčín Phone: +421 (0)32 743 04 72	Slovenia INEA RBT d.o.o. Stegne 11 SI-1000 Ljubljana Phone: +386 (0)1 / 513 8116
Switzerland OMNI RAY AG Im Schörlis 5 CH-8600 Dübendorf Phone: +41 (0)44 / 802 28 80	Ukraine CSC- AUTOMATION Ltd. 4 B, Yevhena Sverstyuka Str. UA-02002 Kiev Phone: +380 (0)44 / 494 33 44					
Egypt EIM Energy 3 Romy Square ET-11341 Heliopolis, Cairo Phone: +202 24552559	Israel GIRIT CELADON Ltd. 12 Haomantut Street IL-42505 Netanya Phone: +972 (0)9 / 863 39 80	Israel ILAN & GAVISH Ltd. 24 Shenkar St., Kiryat Anie IL-49001 Petah-Tikva Phone: +972 (0)3 / 922 18 24	Israel SHERF MOTION TECHN. Ltd. Rehov Hamerkava 19 IL-58851 Holon Phone: +972 (0)3 / 559 54 62	Lebanon CEG LIBAN Cebaco Center/Block A Autostade D'ORA Lebanon-Beirut Phone: +961 (0)1 / 240 445	South Africa ADROIT TECHNOLOGIES 20 Waterford Office Park 189 Wilkoppen Road ZA-Fourways Phone: +27 (0)11 / 658 8100	



version check

Mitsubishi Electric Europe B.V. / FA - European Business Group / Mitsubishi-Electric-Platz 1 / D-40882 Ratingen / Germany /
 Tel.: +49(0)2102-4860 / Fax: +49(0)2102-4861120 / info@mitsubishi-automation.com / https://eu3a.mitsubishielectric.com

Art. no. 167840-1/03.2019 / Specifications subject to change / All trademarks and copyrights acknowledged.

