

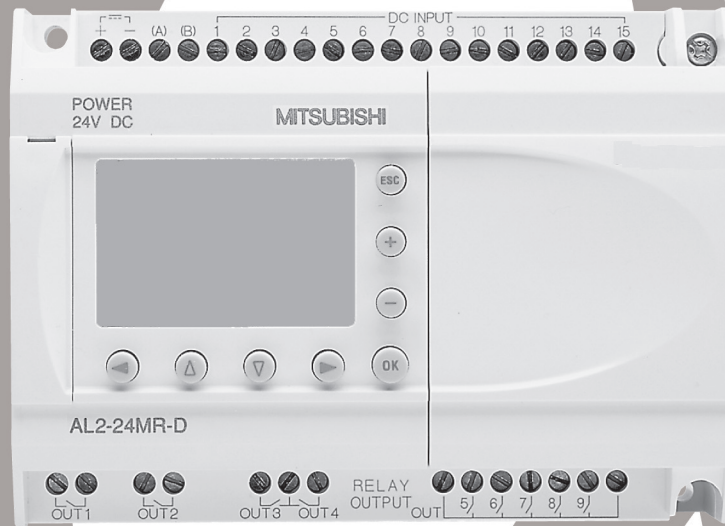

## SIMPLE APPLICATION CONTROLLER



# PROGRAMMING MANUAL

## α2 SIMPLE APPLICATION CONTROLLER

## **Foreword**

- This manual contains text, diagrams and explanations which will guide the reader in the correct programming and operation of the α2 series controller.
- Before attempting to install or use the α2 Series Controller this manual should be read and understood.
- If in doubt at any stage of the installation of the α2 Series Controller always consult a professional electrical engineer who is qualified and trained to local and national standards which apply to the installation site.
- If in doubt about the operation or use of the α2 Series Controller please consult the nearest Mitsubishi Electric distributor.
  
- Under no circumstances will Mitsubishi Electric be liable or responsible for any consequential damage that may arise as a result of the installation or use of this equipment.
- All examples and diagrams shown in this manual are intended only as an aid to understanding the text, not to guarantee operation. Mitsubishi Electric will accept no responsibility for actual use of the product based on these illustrative examples.
- Please contact a Mitsubishi Electric distributor for more information concerning applications in life critical situations or high reliability.
- This manual is subject to change without notice.

This manual confers no industrial property rights or any rights of any other kind, nor does it confer any patent licenses. Mitsubishi Electric Corporation cannot be held responsible for any problems involving industrial property rights which may occur as a result of using the contents noted in this manual.

# **α2 SIMPLE APPLICATION CONTROLLERS**

## **PROGRAMMING MANUAL**

Manual number : JY992D97101

Manual revision : G

Date : 4/2015



## **Guidelines for the safety of the user and protection of α2 Simple Application controllers**

This manual provides information for the use of α2 Simple Application controllers. The manual has been written to be used by trained and competent personnel. The definition of such a person or persons is as follows;

- a) Any engineer who is responsible for the planning, design and construction of automatic equipment using the product associated with this manual should be of a competent nature, trained and qualified to the local and national standards required to fulfill that role. These engineers should be fully aware of all aspects of safety with regards to automated equipment.
- b) Any commissioning or service engineer must be of a competent nature, trained and qualified to the local and national standards required to fulfill that job. These engineers should also be trained in the use and maintenance of the completed product. This includes being completely familiar with all associated documentation for the said product. All maintenance should be carried out in accordance with established safety practices.
- c) All operators of the completed equipment (see Note) should be trained to use this product in a safe manner in compliance to established safety practices. The operators should also be familiar with documentation which is associated with the operation of the completed equipment.

**Note :** The term ‘completed equipment’ refers to a third party constructed device which contains or uses the product associated with this manual.

### **Notes on the Symbols Used in this Manual**

At various times throughout this manual certain symbols will be used to highlight points of information which are intended to ensure the users personal safety and protect the integrity of equipment. Whenever any of the following symbols are encountered its associated note must be read and understood. Each of the symbols used will now be listed with a brief description of its meaning.

#### **Hardware warnings**



1 ) Indicates that the identified danger **WILL** cause physical and property damage.



2 ) Indicates that the identified danger could **POSSIBLY** cause physical and property damage.



3 ) Indicates a point of further interest or further explanation.

#### **Software warning**



4 ) Indicates special care must be taken when using this element of software.



5 ) Indicates a special point which the user of the associate software element should be aware of.



6 ) Indicates a point of interest or further explanation.

## **Registration**

The company name and the product name to be described in this manual are the registered trademarks or trademarks of each company.

# Table of Contents

Safety Guidelines .....	iii
1. Introduction .....	1-1
1.1 Special Features of the Controller .....	1-1
1.2 Model Name .....	1-2
1.3 Version Up List .....	1-3
1.4 Applicable Programming Software .....	1-3
2. Function Block Programming .....	2-1
2.1 Block Type and the FBD base .....	2-1
2.1.1 Inputs .....	2-2
2.1.2 Front Panel Keys .....	2-2
2.1.3 System Memory Bits .....	2-3
2.1.4 Function Blocks .....	2-3
2.1.5 Outputs .....	2-4
2.1.6 Function Block Diagram (FBD) base .....	2-4
2.2 Programming Methods .....	2-5
2.2.1 Direct Programming .....	2-5
2.2.2 AL-PCS/WIN-E Programming Software Ver. 2.50 and upwards ..	2-5
3. System Menu .....	3-1
3.1 Menu Options Instructions .....	3-1
3.2 The Stop Mode .....	3-2
3.2.1 Top Menu .....	3-2
3.2.2 The “Others...” .....	3-6
3.3 The Run Mode Top Menu .....	3-12
3.4 The Edit Menu .....	3-15
3.5 The Function Block Edit Menu .....	3-15
3.6 Option Screen Setup .....	3-16
3.6.1 ProgEdit .....	3-16
3.6.2 Change the Language Setting .....	3-16
3.6.3 ClockSET .....	3-16
3.6.4 RadioClock - DCF77 Decoding .....	3-17
3.6.5 SummerTime .....	3-18
3.6.6 DispPass .....	3-19
3.6.7 Password .....	3-20
3.6.8 Enhanced User Program Protection (Version 2.20 or later) .....	3-20
3.6.9 Serial Com .....	3-22
3.6.10 Memory cassette .....	3-23
3.6.11 Analog Inputs .....	3-24
3.7 LCD Displays .....	3-25
3.7.1 Image Table .....	3-25
3.7.2 LCD Function .....	3-25

3.8 Block Items .....	3-26
3.8.1 Input Blocks .....	3-26
3.8.2 Function Blocks .....	3-26
3.8.3 Output Blocks .....	3-26
3.8.4 Connected Blocks .....	3-26
4. Direct Programming .....	4-1
4.1 Block Availability .....	4-1
4.2 Connecting Blocks .....	4-1
4.2.1 To connect the blocks from the left (signal provider) block to right (signal receiver) block. ....	4-1
4.2.2 To connect the blocks from the right (signal receiver) block to left (signal provider) block. ....	4-2
4.3 Disconnect Two Blocks .....	4-2
4.4 Methods to Create a Function Block .....	4-3
4.4.1 New FB .....	4-3
4.4.2 AddFB .....	4-3
4.5 Function Block Editing .....	4-3
4.5.1 Setup Function Block .....	4-3
4.5.2 Change No. (of a Function Block) .....	4-3
4.5.3 Delete FB .....	4-3
4.6 Movement between Function Blocks .....	4-4
4.6.1 Movement Between Unconnected Blocks .....	4-4
4.6.2 Movement Between Connected Blocks .....	4-4
4.6.3 The Jump Command .....	4-4
4.7 Using Keys as Inputs .....	4-4
4.8 The Monitor Mode .....	4-5
4.8.1 Monitor/Update Function Block Values .....	4-5
4.8.2 Forcing Outputs ON/OFF .....	4-6
4.8.3 Add/Delete Function Blocks in the Monitor Mode .....	4-6
5. The Logic Function Blocks .....	5-1
5.1 The AND Block .....	5-2
5.2 The OR Block .....	5-3
5.3 The NOT Block .....	5-4
5.4 The XOR Block (Exclusive OR) .....	5-4
5.5 The NAND Block (Not AND) .....	5-5
5.6 The NOR Block (Not OR) .....	5-6



6. Function Blocks .....	6-1
6.1 Definitions .....	6-8
6.2 Abbreviations .....	6-8
6.3 Boolean block .....	6-9
6.4 Set/Reset Block .....	6-11
6.5 Pulse Block .....	6-13
6.6 Alternate Block .....	6-15
6.7 Delay Block .....	6-16
6.8 One Shot Block .....	6-18
6.9 Flicker Block .....	6-20
6.10 TimeSW Block .....	6-23
6.10.1 Setting the First Time Switch .....	6-23
6.10.2 For the Date operation: .....	6-24
6.10.3 For the Weekly Operation: .....	6-24
6.10.4 To Enter New Time Switches .....	6-24
6.10.5 To Edit Time Switches .....	6-25
6.10.6 To Delete Time Switch Data .....	6-25
6.11 Counter Block .....	6-26
6.12 Up/Down Counter Block .....	6-27
6.13 Compare Block .....	6-29
6.14 Analog Output .....	6-31
6.15 OFFSET Block .....	6-34
6.16 Display Block .....	6-37
6.16.1 Displaying Data Onscreen .....	6-37
6.16.2 Editing Data Onscreen .....	6-38
6.17 Zone Compare Block .....	6-41
6.18 Schmitt Trigger Block .....	6-43
6.19 Hour Meter Block .....	6-46
6.20 Speed Detect Block .....	6-48
6.21 Pulse Width Modulation .....	6-53
6.22 PID Block .....	6-55
6.22.1 Parameter List and PID Details. ....	6-56
6.22.2 Setting the Input Values, SV and PV .....	6-58
6.22.3 Setting the Function Block Parameters .....	6-58
6.22.4 Limiting the Manipulated Value .....	6-61
6.22.5 Setting KP, TI, and TD with Auto-tuning .....	6-62
6.22.6 PID Troubleshooting .....	6-64
6.22.7 Error Codes .....	6-64
6.23 Retentive Alternate Block .....	6-69
6.24 Addition Block .....	6-70
6.25 Subtraction Block .....	6-71
6.26 Multiplication Block .....	6-72
6.27 Division Block .....	6-73
6.28 Calculation Block .....	6-74
6.29 Shift Block .....	6-76

6.30 GSM/SMS Block .....	6-78
6.30.1 Input Signal .....	6-80
6.30.2 Output Signal .....	6-80
6.30.3 Word Output .....	6-80
6.30.4 Short Message Service (SMS) .....	6-81
6.30.5 Comment/Signal Number .....	6-81
6.30.6 Setting .....	6-81
6.30.7 Destination .....	6-81
6.30.8 SMS Setting Dialog Box .....	6-82
6.30.9 SMS Service Center .....	6-82
6.30.10 Valid Period .....	6-82
6.30.11 Destination .....	6-82
6.30.12 Error Messages .....	6-83
6.31 Short Message Receiving Block .....	6-89
6.31.1 Authentication and Security .....	6-91
6.31.2 SM Commands .....	6-92
6.31.3 Report Short Message Handling .....	6-93
6.31.4 SMR (Short Message Receiving) Setting Dialog Box .....	6-94
6.32 Call Detect Block .....	6-95
6.32.1 Number of RING .....	6-96
6.33 Random One Shot Block .....	6-97
6.34 Delayed One Shot Block .....	6-99
6.35 Delayed Alternate Block .....	6-102
6.36 Retentive Set Reset Block .....	6-104
6.37 Control Display Manager .....	6-106
6.37.1 Operation Image: .....	6-107
6.37.2 To Set Display Manager: .....	6-108
6.38 Connect Block .....	6-114
7. Let's Make a Program .....	7-1
7.1 Option Settings .....	7-1
7.2 The Function Block Diagram .....	7-1
7.3 Input the Program .....	7-2
7.3.1 Adding Function Blocks by the Left to Right method (Section 4.2.1) .....	7-2
7.3.2 Scroll through the Function Blocks by Number (Section 4.6.1) ....	7-3
7.3.3 Use the Jump Command (Section 4.6.3) .....	7-3
7.3.4 Use the NewFB command .....	7-4
7.3.5 Connect the Function Blocks from Right to Left (Section 4.2.2) ..	7-4
7.4 Set up the Function Block Parameters (Section 4.5.1) .....	7-5
7.5 Exit the Function Block Diagram board .....	7-6
8. Appendix .....	8-1
8.1 Associated Manuals .....	8-1
8.2 System Keys .....	8-2
8.3 System Bits .....	8-2
8.4 Boolean Gates .....	8-3
8.5 PID Formulas .....	8-9

# 1. Introduction

The α2 Series Controllers provides supervisory control for use in the home, office, factory or wherever you need it. The α2 Series Controllers offers flexible I/O control for varied applications:

## Applications

The α2 Series is designed to be used for automatic applications including:

- Lighting, air-conditioning or watering control
- Opening and closing gates
- Security systems
- Domestic systems
- Temperature control

However, the α2 Series Controllers is not designed to be used in the following applications:

- Applications where high reliabilities such as nuclear power control, railway facilities, airline facilities, vehicles, combustion equipment and medical equipment are required.
- Applications in life critical situations

Please contact a Mitsubishi distributor for more information.

## 1.1 Special Features of the Controller

### 1 ) Display messages and Function Block data

The α2 Series Controller can display the state of operation and the status of an alarm on the LCD screen as a message. The α2 Series Controller allows the values of timers and counters to be changed while in RUN mode.

- Total characters on LCD display: 12 characters x 4 lines
- Display items: Message, values (current or set) of timers and counters, analog values, etc.

### 2 ) Program Input

The user can program directly from the front panel or use the windows based AL-PCS/WIN-E programming software Ver. 2.00 and upwards. Pictorial representations of data are used to connect function blocks in both methods. Please refer to the α Software Manual for details on AL-PCS/WIN-E.

### 3 ) Enhancement of clock function

The calendar timer function can switch inputs to time-dependent controls on a daily or weekly basis.

### 4 ) Analog input, 0-10V/0-500

The DC input type for the α2 Series accepts 0-10V signals with a digital range of 0-500 (50 divisions per volt).

### 5 ) High Speed Counter (max. 1kHz)

The α2 Series Controller can have two dedicated high speed counters when using AL2-4EX EI1 and EI2.

- 6 ) High current output  
The Relay outputs can handle 8A per common (COM) in the main units: AL2-10MR-\* (O01-6); AL2-14MR-\* (O01-6); AL2-24MR-D (O01-04). Transistor outputs are 1A/point in the extension module.
- 7 ) GSM Function (AL2-14MR-\*, AL2-24MR-\*)  
The α2 Series Controller uses GSM to send a short message to a mobile phone or a dedicated E-mail account via a standard service provider. By receiving a short message FB bit outputs or word output values can be changed.
- 8 ) Dedicated Protocol (AL2-14MR-\*, AL2-24MR-\*)  
The α2 Series Controllers introduces this concept allowing the user to monitor, modify and enter current and set values in Function Blocks from a personal computer.
- 9 ) Built-in EEPROM  
The built in EEPROM stores the user program non-volatile.
- 10 ) Supports 7 languages  
The system supports the following languages: English, German, French, Italian, Spanish, Swedish and Russian\*1.  
\*1 Ver.3.00 or later
- 11 ) LCD Screen  
Enhanced LCD screen size displays data more clearly and enables the α2 Series Controller to display bar graphs and other new data representations.
- 12 ) Increased Memory  
The CPU memory for the α2 Series Controller can store 5 kbyte of programming or a maximum of 200 function blocks.

This manual will describe front panel programming of the α2 Series Controllers, the powerful function block capabilities, and the functions of the front panel keys.

## 1.2 Model Name

The α2 Series Controllers can be identified using the following format:

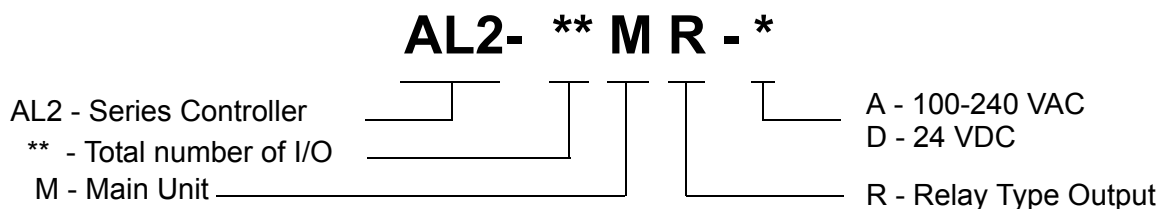

### 1.3 Version Up List

Table 1.1: History of α2 Series

Version	Description
V1.00	First product
V2.00	Supports the following points. <ul style="list-style-type: none"> <li>• AL2-2DA, AL2-2PT-ADP, AL2-2TC-ADP modules</li> <li>• New function blocks AO [Analog output] and PID [PID control]</li> <li>• DCF77 Radio clock</li> </ul>
V2.20	Supports the following points. <ul style="list-style-type: none"> <li>• New function blocks SMR[Short Message Receiving] and CD[Call Detect]</li> <li>• Enhanced User Program Protection</li> <li>• Enhanced Daylight Saving Time Setup</li> <li>• Enhanced Dedicated Protocol Communication</li> <li>• GSM SIM PIN</li> <li>• Modem Initialization String</li> </ul>
V3.00	Supports the following points. <ul style="list-style-type: none"> <li>• Hour Meter backs up by EEPROM (No.197 - 200)</li> <li>• Display Buffer Read by Dedicated Protocol</li> <li>• Russian language addition</li> </ul>

### 1.4 Applicable Programming Software

Table 1.2: Applicable Programming Software

α2 Version	Programming Software (AL-PCS/WIN-E) Version
V1.00	V2.00 or later
V2.00	V2.30 or later
V2.20	V2.40 or later
V3.00	V2.50 or later



**Note;**

- AL-PCS/WIN-E versions lower than V2.00, do not communicate with the α2 series.
- AL-PCS/WIN-E versions lower than V2.30, do not use the AL2-2DA, AL2-2PT-ADP or AL2-2TC-ADP.

# MEMO

## 2. Function Block Programming

The α2 Series Controller is programmed with a user-friendly method of combining special-purpose dedicated function blocks. The task is broken down into various stages which can be represented by a number of function blocks. Function Block Programming simplifies application representation but ensures complete process control. The program can be developed in very simple steps but even a complex task can be represented in this way. For ease of use, the function blocks have been preprogrammed to perform certain tasks yet offer flexibility to be tailored to individual requirements.

Figure 1.1: Principle of Function Block Programming

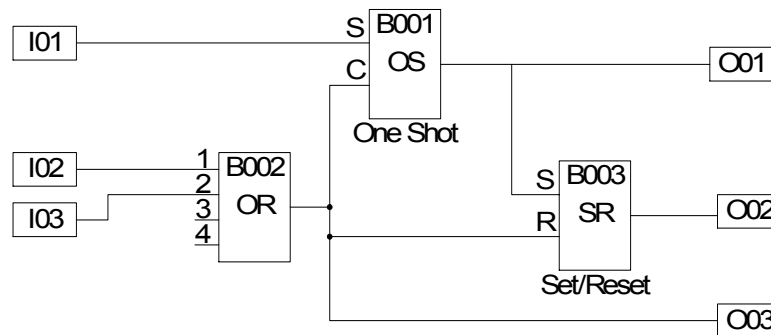

- I0n - Input n
- O0n - Output n
- OR - OR Boolean Function Block
- SR - Set/Reset Function Block
- OS - One Shot Function Block

The user can build a complex circuit in small, easy steps by starting at the input and working forward in a logical manner. The α2 will gather and process information and provide the necessary control for the application according to the system algorithm. Each function block provides specific control parameters, accessible by the user, to tailor each program for complete application suitability. The function blocks are connected together to form a circuit using the Function Block Diagram (FBD.)

### 2.1 Block Type and the FBD base

There are seven sets of items that can be used in the function block program: Inputs, Front Panel Keys, System Memory Bits, Logic Blocks, Function Blocks, User-defined Function Blocks and Outputs. A brief description of each follows.

### 2.1.1 Inputs

The α2 Series Controller will accept both digital (On/Off) and analog (mV value based) electrical information through the system Inputs. Please refer to the α2 Hardware Manual for electrical information, wiring diagrams and input specifications. Depending on the specific controller there are either 14 or 24 input version types of the α2 Series Controller. The Inputs are referenced to I01, I02, ..., I15.

Table 2.1: Input type for the AL2-10MR-\* Controller

Input	Input Number	Description
Signal	I01 - I06	Maximum of 6 Inputs are allocated for use.
Analog (AL2-10M*-D)	A01 - A06	Maximum of 6 Analog inputs are allocated for use on input I01 to I06.

Table 2.2: Input type for the AL2-14MR-\*, AL2-24MR-\* Controller

Input	Input Number	Description
Signal	I01 - I15	Maximum of 15 Inputs are allocated for use.
AS-i	E01 - E04	Maximum of 4 AS-interface inputs are allocated for use.
Analog (AL2-**M*-D)	A01 - A08	Maximum of 8 Analog inputs are allocated for use on input I01 to I08.
Extension	EI01 - EI04	Maximum of 4 Extension inputs are allocated for use.

### 2.1.2 Front Panel Keys

The front panel keys can enter data into the program memory, move through menus or programs, select programming options, or be used as extra inputs when the program is running. There are eight keys which are referenced as K01 - K08.

Table 2.3: Front panel keys for the α2 Series Controller

Key Name	Key number	Key Function
OK	K01	Used to enter menu options, confirm data entry, and manually force inputs ON/OFF in the monitor function.
ESC	K02	Used to cancel an operation, move to a higher level screen, or to move to a new menu.
“+”	K03	Used to connect (or “add”) function blocks, increase Direct Set input values or times, or move through programs or menus.
“-”	K04	Used to disconnect function blocks, decrease Direct Set values or times, or move through programs or menus.
(▲)	K05	Scroll up through menu options (menus, keys, FB, Inputs, Outputs, etc.)
(▼)	K06	Scroll down through menu options (menus, keys, FB, Inputs, Outputs, etc.)
(▶)	K07	Move to the right on the LCD display, FB program, or Jump command
(◀)	K08	Move to the left on the LCD display, FB program, or Jump command



If the front panel keys are used as auxiliary inputs on the FBD, their primary function, as front panel display navigators, will be disabled.



### 2.1.3 System Memory Bits

These System Memory Bits can provide predefined signals - Always On, Always Off, 0.5 second On, 0.5 second Off, or provide information about the Real Time Clock time or errors etc. There are 24 Memory bits that are referenced as M01, M02, ... M24.

Table 2.4: System Bits for the α2 Series Controller

System Bit	Description	AL2-10M	AL2-14M AL2-24M
M01	Always "ON".	✓	✓
M02	Always "OFF".	✓	✓
M03	Alternate - 0.5 seconds "ON", 0.5 seconds "OFF".	✓	✓
M04	"ON" when Real Time Clock data error occurs.	✓	✓
M05	"ON" when Summer time schedule is activated.	✓	✓
M06	"ON" when AS-interface communication Error occurs.	–	✓
M07	"ON" when communication Error caused by AS-interface power failure occurs.	–	✓
M08	Pulses "ON" when Stop mode turns to Run mode in the α2 Series.	✓	✓
M09	Pulses "OFF" when Stop mode turns to Run mode in the α2 Series.	✓	✓
M10	"ON" during DCF77 decoding	✓	✓
M11	Pulses "ON" when DCF77 finishes decoding without an error	✓	✓
M12	"ON" when CD (DCD) signal is turned ON (receiving CD signal from the modem.)	–	✓
M13	"ON" when it is possible to access the GSM network.	–	✓
M14	"ON" when the α2 series controller is accessed via GSM	–	✓
M15	"ON" when DCF77 finishes decoding with an error	✓	✓
M16	"ON" when external power for the 2DA board is on	–	✓
M17	"ON" when there is a sensor defect at I01	✓	✓
M18	"ON" when there is a sensor defect at I02	✓	✓
M19	"ON" when there is a sensor defect at I03	✓	✓
M20	"ON" when there is a sensor defect at I04	✓	✓
M21	"ON" when there is a sensor defect at I05	✓	✓
M22	"ON" when there is a sensor defect at I06	✓	✓
M23	"ON" when there is a sensor defect at I07	–	✓
M24	"ON" when there is a sensor defect at I08	–	✓

### 2.1.4 Function Blocks

Programming the α2 Series Controller is based upon the combination of different function blocks. They process the information received from the previously mentioned inputs and control the system Outputs. They can also provide input signals or information to other function blocks using word outputs pins. To make programming easier, the Function Blocks have all been preprogrammed. However, parameters within each function block dialog box can be set according to the intended application. There are 40 Function Blocks available, they are described in detail throughout Chapters 5 and 6.

### 2.1.5 Outputs

Table 2.5: Outputs for the AL2-10MR-\* Controller

Outputs	Description
O01 - 04	Signal output
N01	No
N02*1	ON: The back light is "OFF" in LCD. OFF: The back light is controlled by the "Light Time" setting in Menu.
N03*1	ON: The back light is "ON" in LCD. OFF: The back light is controlled by the "Light Time" setting in Menu.
N04	ON: The user screen is controlled by the setting of "Display Manager" with AL-PCS/ WIN-E. OFF: The user screen is controlled by user program.

Note: \*1 When both N02 and N03 are ON and hence the back light is "ON" because N03 is given the priority.

Table 2.6: Outputs for the AL2-14MR-\*, AL2-24MR-\* Controller

Outputs	Description
O01 - 09	Signal output
A01 - 04	AS-interface Output
EO1 - E04	Extension Output
N01	ON: Disconnected to AS-interface network OFF: Connect to AS-interface network
N02*1	ON: The back light is "OFF" in LCD. OFF: The back light is controlled by the "Light Time" setting in Menu.
N03*1	ON: The back light is "ON" in LCD. OFF: The back light is controlled by the "Light Time" setting in Menu.
N04	ON: The user screen is controlled by the setting of "Display Manager" with AL-PCS/ WIN-E. OFF: The user screen is controlled by user program.

Note: \*1 When both N02 and N03 are ON and hence the back light is "ON" because N03 is given the priority.

### 2.1.6 Function Block Diagram (FBD) base

The Function Block Diagram provides the base for which all programming actions for the α2 is performed. Both the α2 controller and the AL-PCS/WIN-E software use the FBD base. The FBD base contains a Title rectangle on the top, Input rectangles on the left and Output rectangles on the right. The FBD base is also known as FBD wiring area. All the components should be placed only within the FBD base rectangle except for the input and output signals which can be placed in the FBD wiring area or in the Input or Output rectangles.

## 2.2 Programming Methods

### 2.2.1 Direct Programming



Direct Programming uses the keys on the front panel to create the program and enter any required data values. The method for Direct Programming is explained in Chapter 4 of this manual.

### 2.2.2 AL-PCS/WIN-E Programming Software Ver. 2.50 and upwards

This windows based software allows the user to drag and drop the desired Function Block icons onto the FBD base and construct a program. The program is downloaded to the α2 controller via the AL-232CAB cable. The visual on-screen connections make the software easy to grasp for beginners and experienced users alike. The AL-PCS/WIN-E Programming Software is fully explained in the α Software Manual (JY992D74001).

Figure 2.1: AL-PCS/WIN-E Programming Software Ver. 2.50 and upwards

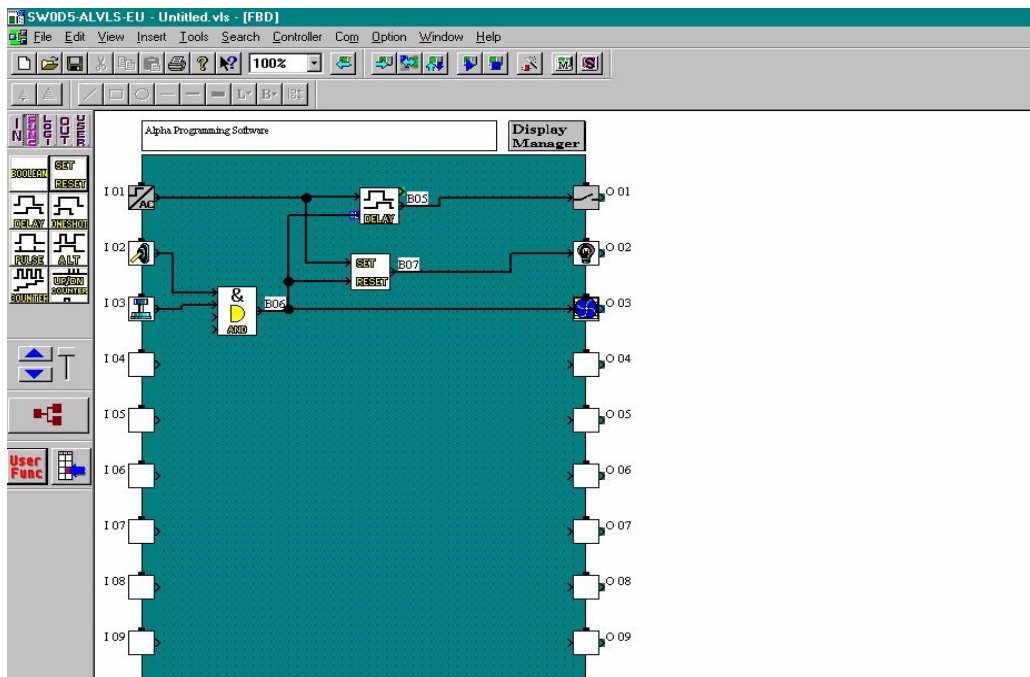

Note: Do not simultaneously program the α2 Series Controller from the direct programming keys and AL-PCS/WIN-E Ver. 2.00 methods as this may result in unexpected operation and possibly cause harm.

# MEMO

### **3. System Menu**

#### **3.1 Menu Options Instructions**

There are Systems Menus to help guide the user through the options available in the α2. The TopMenu has a Run Mode that is accessed while the α2 is in operation or a Stop Mode that is accessed when the α2 is idle.

The Edit Menu and the Function Block Edit Menu can be accessed when in either ProgEdit or Monitor. These menus can be used to create and/or change programs steps or values.

Use the “OK” key to enter a programming option or to enter data into memory. Set all the data on the screen before using the “OK” key to write the data to the system memory. If there are multiple data screens in an option, enter the required data and accept each screen with the “OK” key.

The “ESC” key will move the screen back to a higher menu option. It will cancel any data input that has not been accepted with the “OK” key.



**Note:**

Use the “ESC” key to exit the option to the higher menu; at times, it will be necessary to press the “ESC” key a number of times to move through multiple programming layers.

## **3.2 The Stop Mode**

### **3.2.1 Top Menu**

When the α2 is first turned On, the Input/Output Image Table will appear. Press the “OK” and “ESC” keys simultaneously to move to the TopMenu.

(If the TopMenu cannot be accessed the Menu Key has been set to “Not Use”),

- **Run:**  
Places the controller in Run mode.
- **Parameter:**  
Provides a simple method to edit Time Switches (TSm), Short Message Receive (SMRm) and Call Detect (CDm) from the Top Menu.
- **ProgEdit:**  
Allows program editing/creation on the display using the front panel keys. The current memory will be overwritten as changes are made to the program. Programs can be saved on an AL2-EEPROM-2 memory cassette or in the AL-PCS/WIN-E software Ver. 2.00 or later.
- **ClockSet:**  
Set the Real Time Clock or input a daily clock adjustment. The RadioClock function is also available here.
- **LANGUAGE:**  
Choose from 7 onscreen languages: English, German, French, Italian, Spanish, Swedish, or Russian\*1.
- **OTHERS...**

\*1 Ver. 3.00 or later

Figure 3.1: TopMenu in Stop Mode Operation

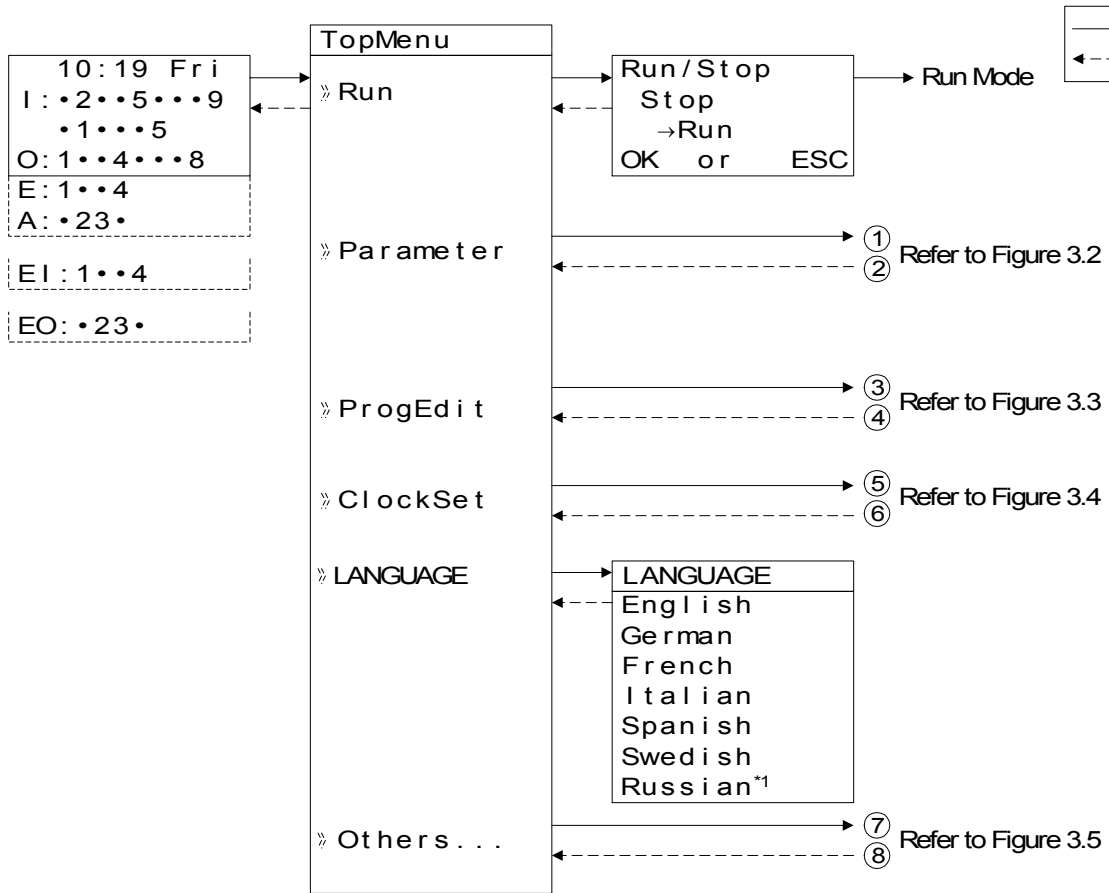

\*1 Ver. 3.00 or later

Figure 3.2: Parameter Menu in Run/Stop Mode Operation

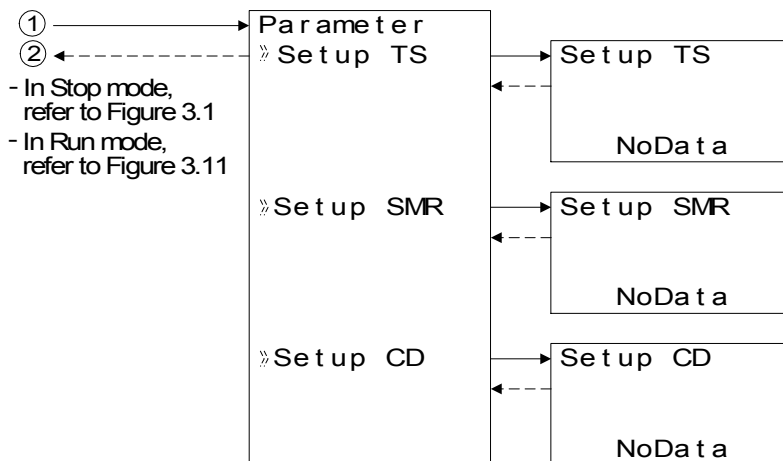

Figure 3.3: ProgEdit Menu in Stop Mode Operation

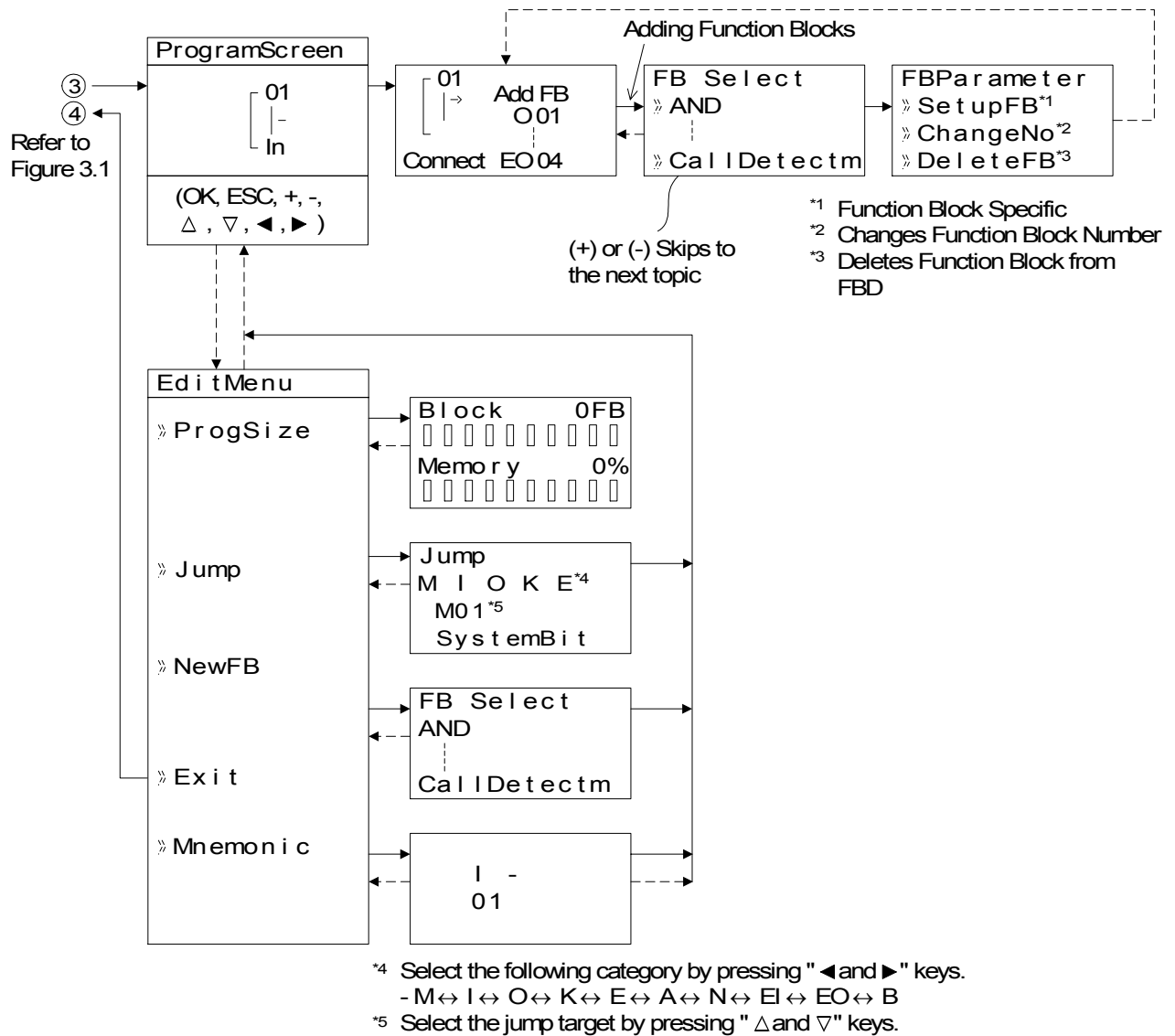
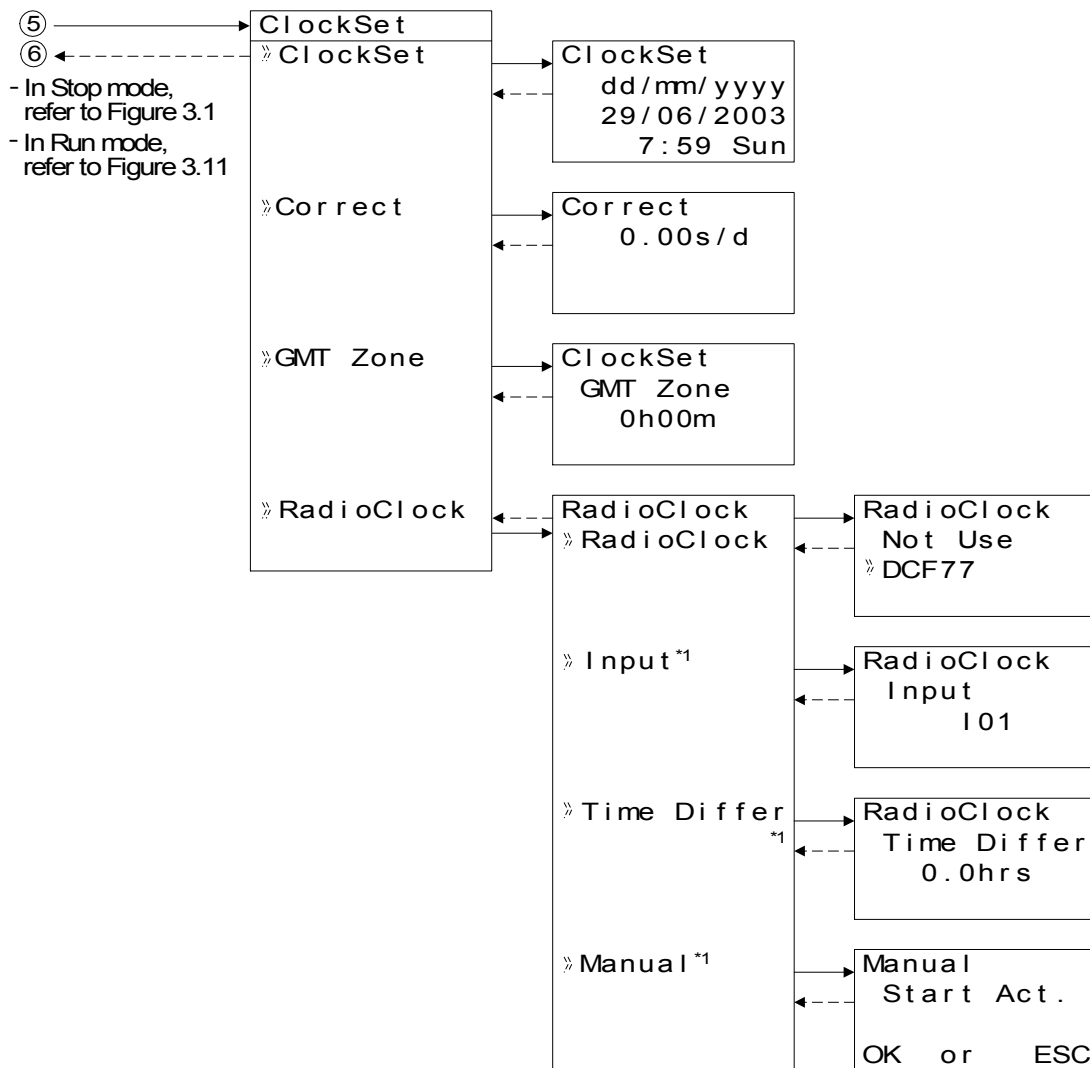



Figure 3.4: ClockSet Menu in Run/Stop Mode Operation



\*1 When DCF77 Radio Clock menu is not set, these items will not be displayed.



**Caution**

When setting the Real Time Clock or inputting a daily clock adjustment to the following menu functions, please change the mode to Stop.

- ClockSet in ClockSet Menu
- Correct in ClockSet Menu

### **3.2.2 The “Others...”**

- **Version:**  
Displays CPU Version of the α2 Series Controller.
- **Scan Time:**  
Monitor the Current, Maximum, or Minimum program scan times. Upon controller reset current, Maximum and Minimum values for scan times are reset to 0.
- **Password:**  
Restrict entry to the ProgEdit and Monitor mode with a four digit password.
- **DispPass:**  
Set up to three Passwords for Display function blocks.
- **Menu Key:**  
Two settings are possible, “Not Use” or “OK + ESC”. “Not Use” is designed so that unauthorized people cannot access the α2 Top Menu in Run mode. If the “OK + ESC” key setting is selected, simultaneously depress the “OK” and the “ESC” keys to access the Top Menu.
- **Summertime:**  
Choose the preferred daylight savings time: Cancel, Manual On, Date Type, UK type, US type, or EU type.
- **Serial Com:**  
Choose the type of communication to be used for the right hand side serial communication port - Not Use, Modem, GSM or Other Com.
- **Light Time:**  
Set the backlight off delay time.
- **Analog In:**  
Indicates the current modes (Normal, TC or PT100) of the Analog inputs and the menu item for changing the temperature scale (°C or °F) that the controller displays. Also contains the menu items for calibration and offset adjust.
- **ProgClear:**  
Completely clears the system memory including Password protected programs. Only the active memory is cleared, i.e. if a memory cassette is installed, the memory cassette program will be erased but the controller memory will be retained.
- **ProgTran. (only appears if a cassette is installed):**  
Verify, Cassette → (the cassette writes to the α2), Cassette ← (the cassette reads from the α2), and ProtectSW are the options available.

Figure 3.5: Others Menu in Stop Mode Operation

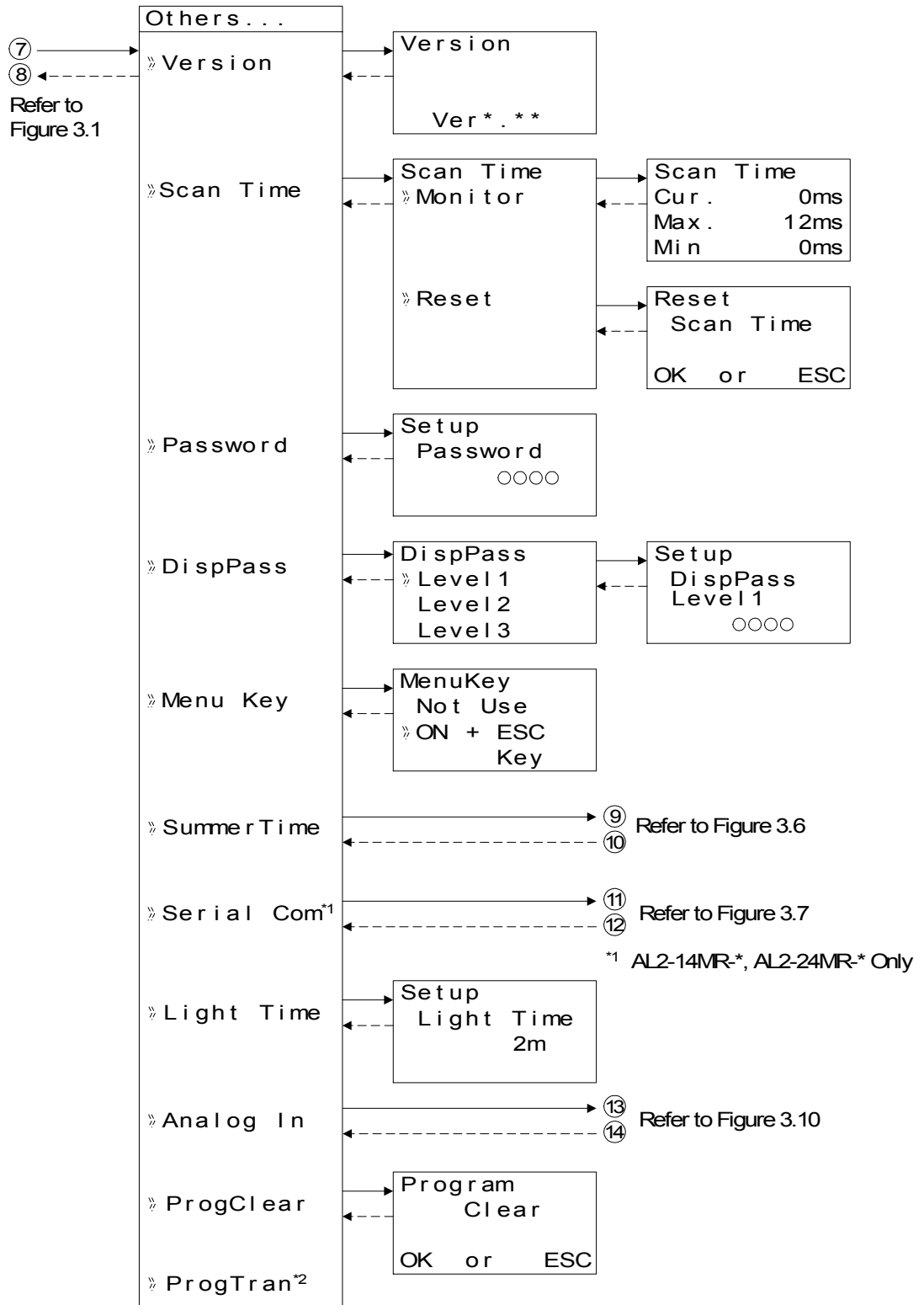

\*2 ProgTran menu is only displayed when connecting AL2-EEPROM-2 memory cassette.

Figure 3.6: Summer Time in Run/Stop Mode Operation

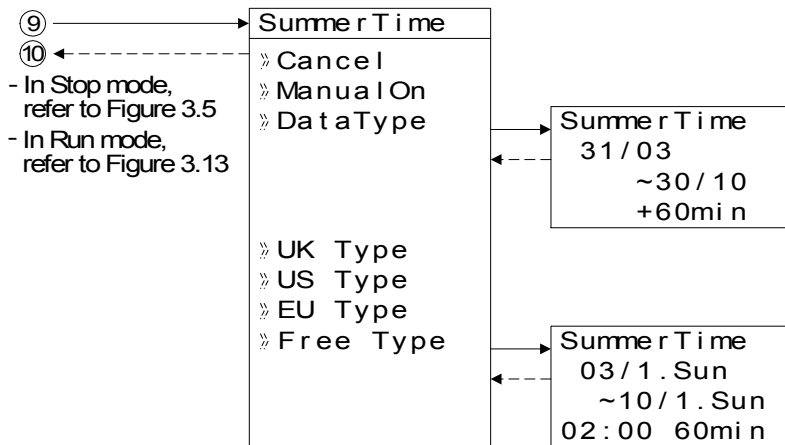

Figure 3.7: Serial Com in Run/Stop Mode Operation (AL2-14MR-\*, AL2-24MR-\* Only)

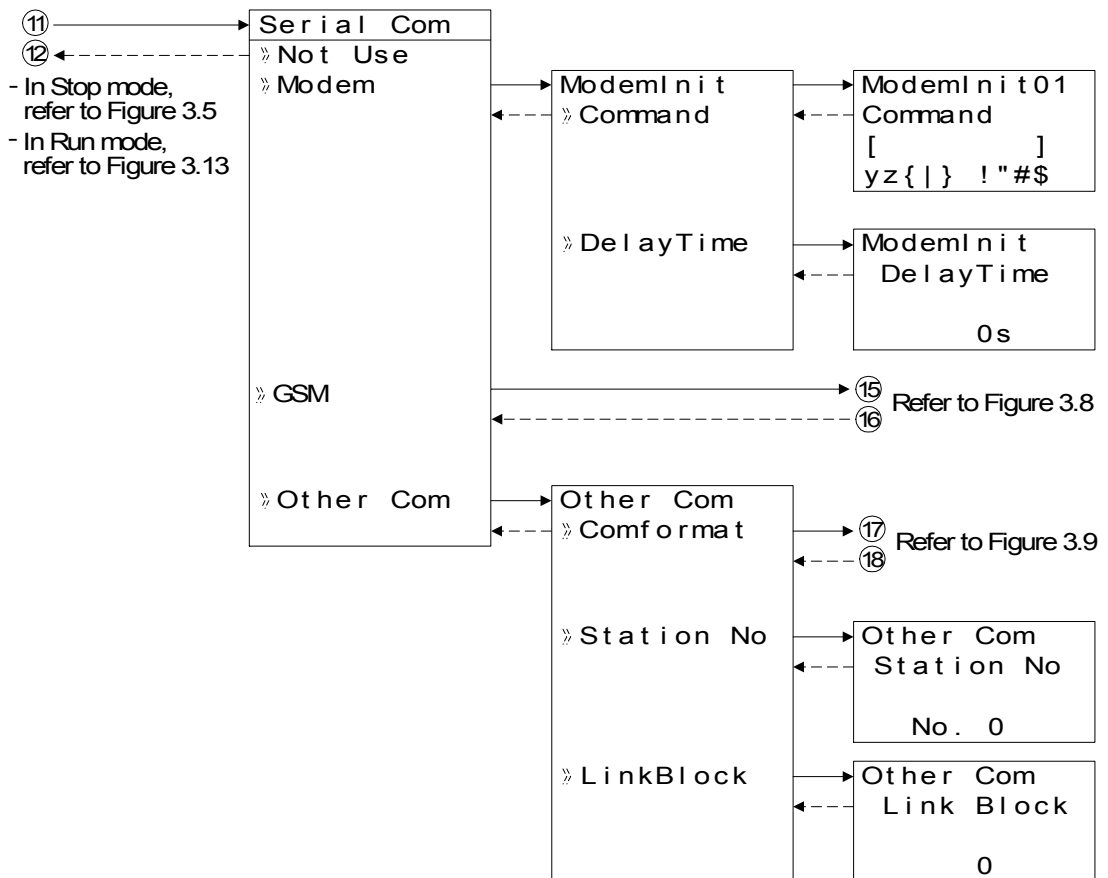

Figure 3.8: GSM Menu in Run/Stop Mode Operation

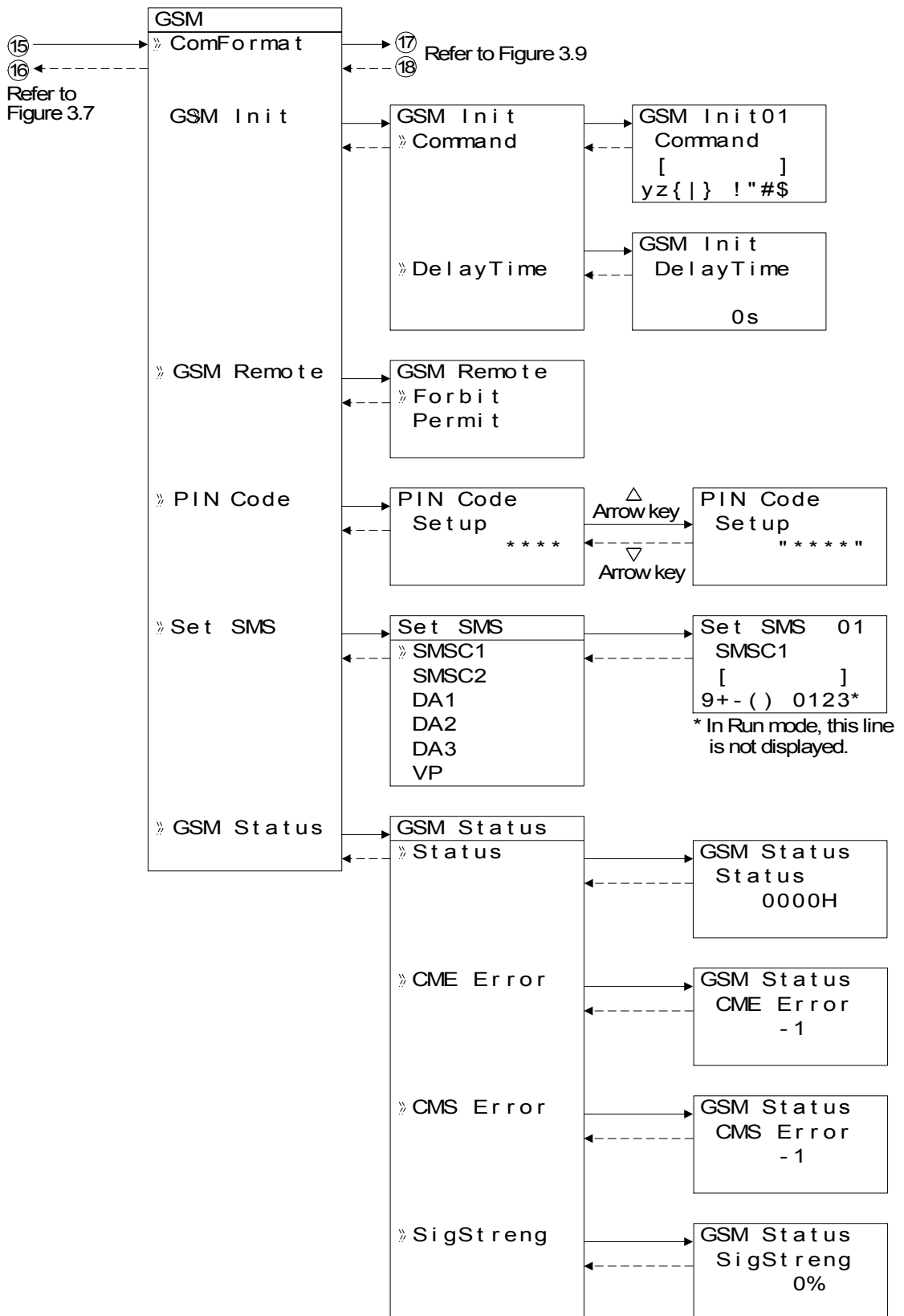

Figure 3.9: ComFormat in Run/Stop Mode Operation

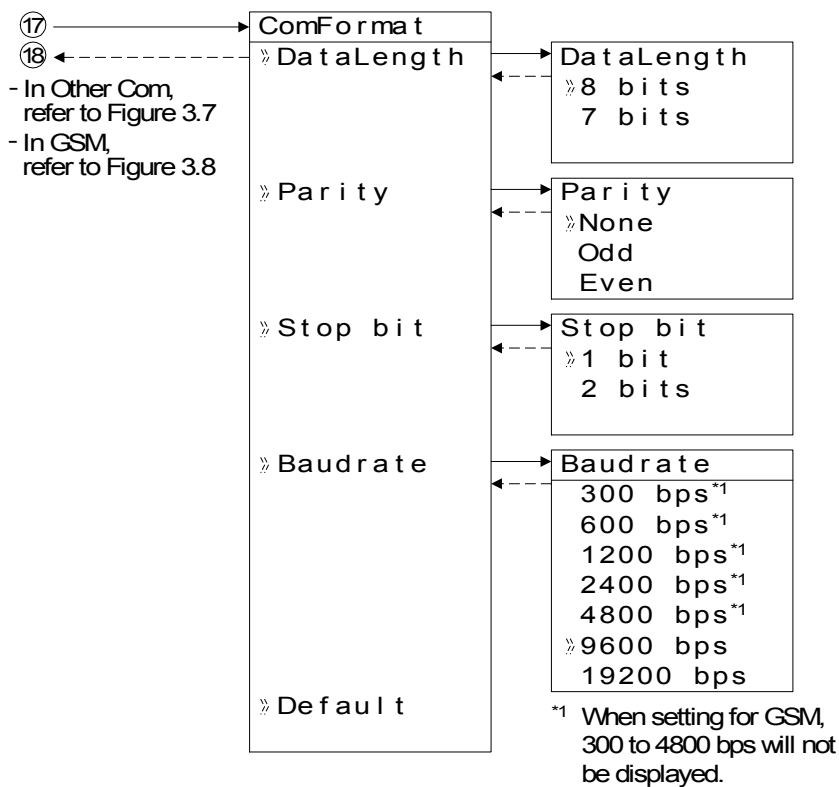
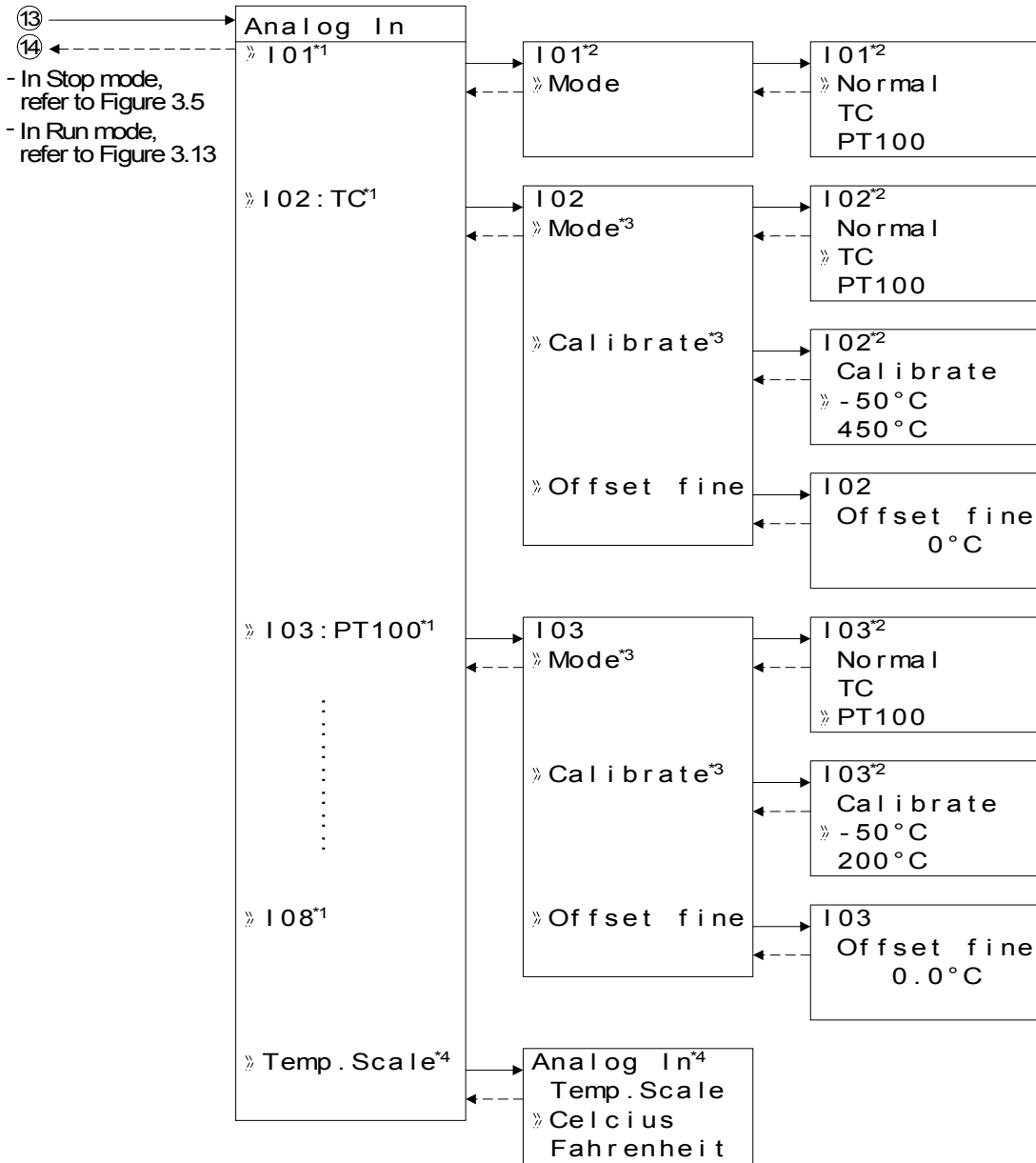

Figure 3.10: Analog Inputs Setup Menu in Run/Stop Mode Operation.



- \*1 This display example is set to I01-I08 as follows  
 I01, I04-I08: Normal setting (Default)  
 I02: TC setting  
 I03: PT100 setting
- \*2 In Run mode, this screen can not be displayed.
- \*3 In Run mode, these items can not be selected.
- \*4 In Run mode, this setting can not be changed.

### 3.3 The Run Mode Top Menu

When the α2 program is running, the LCD defaults to the Image Table screen. According to the Menu Key setting, proceed to the Stop Mode of the Top Menu by using the “OK” and the “ESC” keys or reset the controller by powering down.

- **Stop:**  
Takes the α2 out of Run mode.
- **Setup TS:**  
Provides a simple method to edit Time Switches from the Top Menu.
- **Monitor:**  
Monitor the program settings while in the Run mode and perform limited editing to FB parameters. The existing programming steps cannot be modified.
- **ClockSet:**  
Set the Real Time Clock, input a daily clock adjustment or set the RadioClock function.



**Caution**

When setting the Real Time Clock or inputting a daily clock adjustment to the following menu functions, please change the mode to Stop.

- ClockSet in ClockSet Menu
- Correct in ClockSet Menu

- **LANGUAGE:**  
Choose the on-screen language from English, German, French, Italian, Spanish, Swedish, or Russian\*1.
- **Others**

\*1 Ver. 3.00 or later



**TOP MENU is not Displayed in Run Mode**

The menu key should be operated to access the Top Menu. Push the keys “OK” and “ESC” at the same time. If the menu call key is not set, use either the programming software to the Stop mode or do the forced stop operation.



**Caution**

Perform the forced stop operation only after thoroughly checking that it is safe to do so. Damage to the machine or controller or a safety issue could arise if the forced ON/OFF is performed inappropriately. If proper precautions are not taken, damage to the equipment or machine failure may occur.

**Forced Stop Operation**

- 1) Turn the α2 series power supply off.
- 2) Turn the power ON again while pushing the “OK” and “ESC” keys simultaneously.  
The screen at right is displayed.

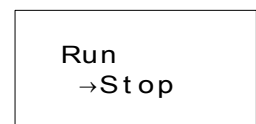

The option to place the controller in Stop mode will be available for approximately five seconds. Press the “OK” key to enter the Stop Mode. If no key is pressed, the controller will default back into the Run mode.

- 3) Press “ESC” key.  
The “Run Mode Top Menu” is displayed.



Figure 3.11: TopMenu in Run Mode Operation

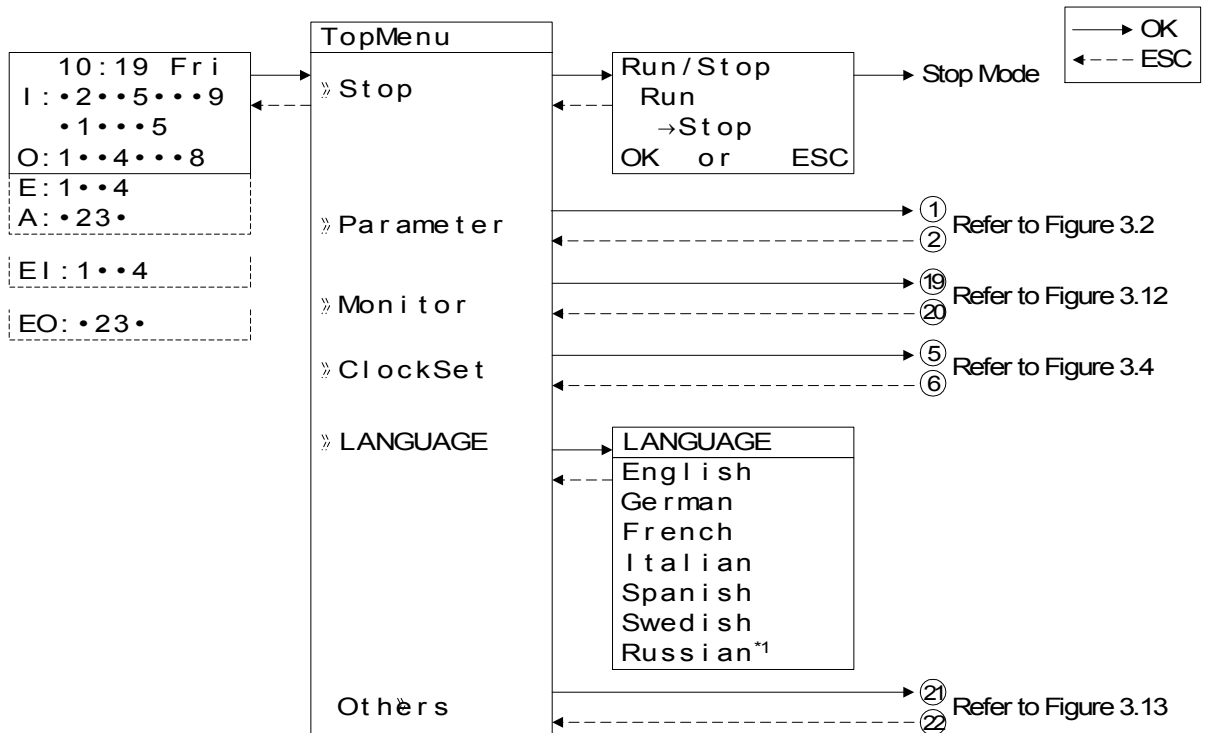

\*1 Ver. 3.00 or later

Figure 3.12: Monitor Screen in Run Mode Operation

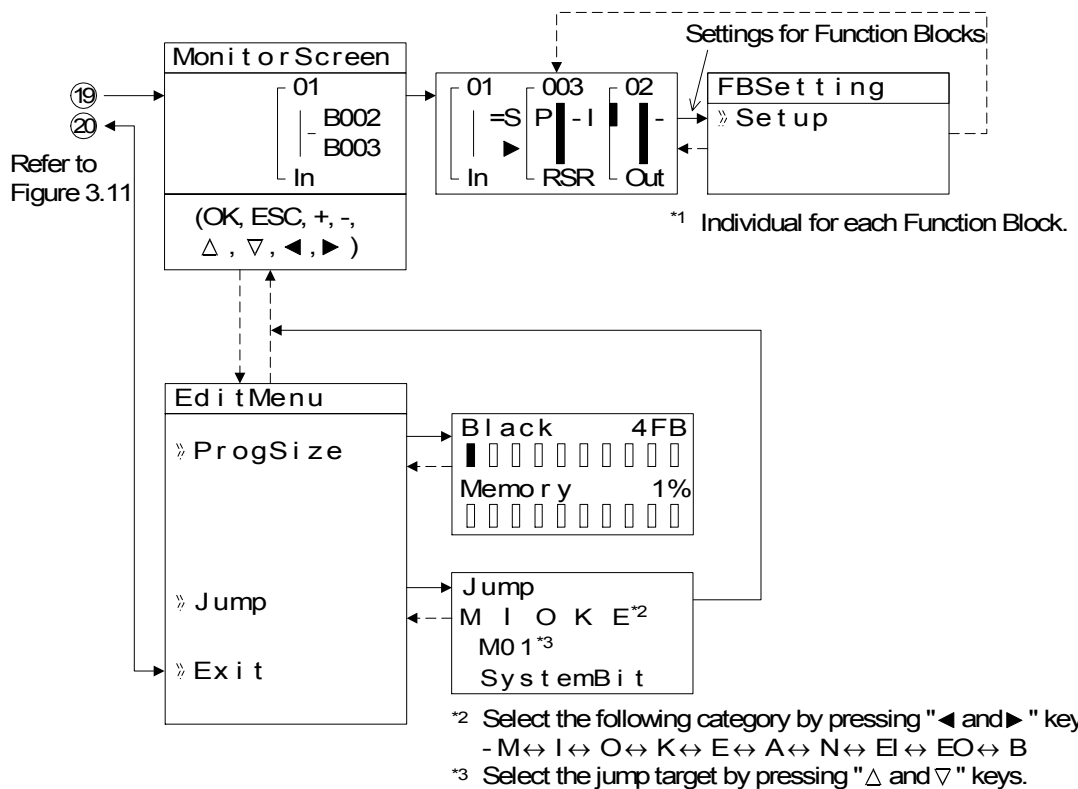
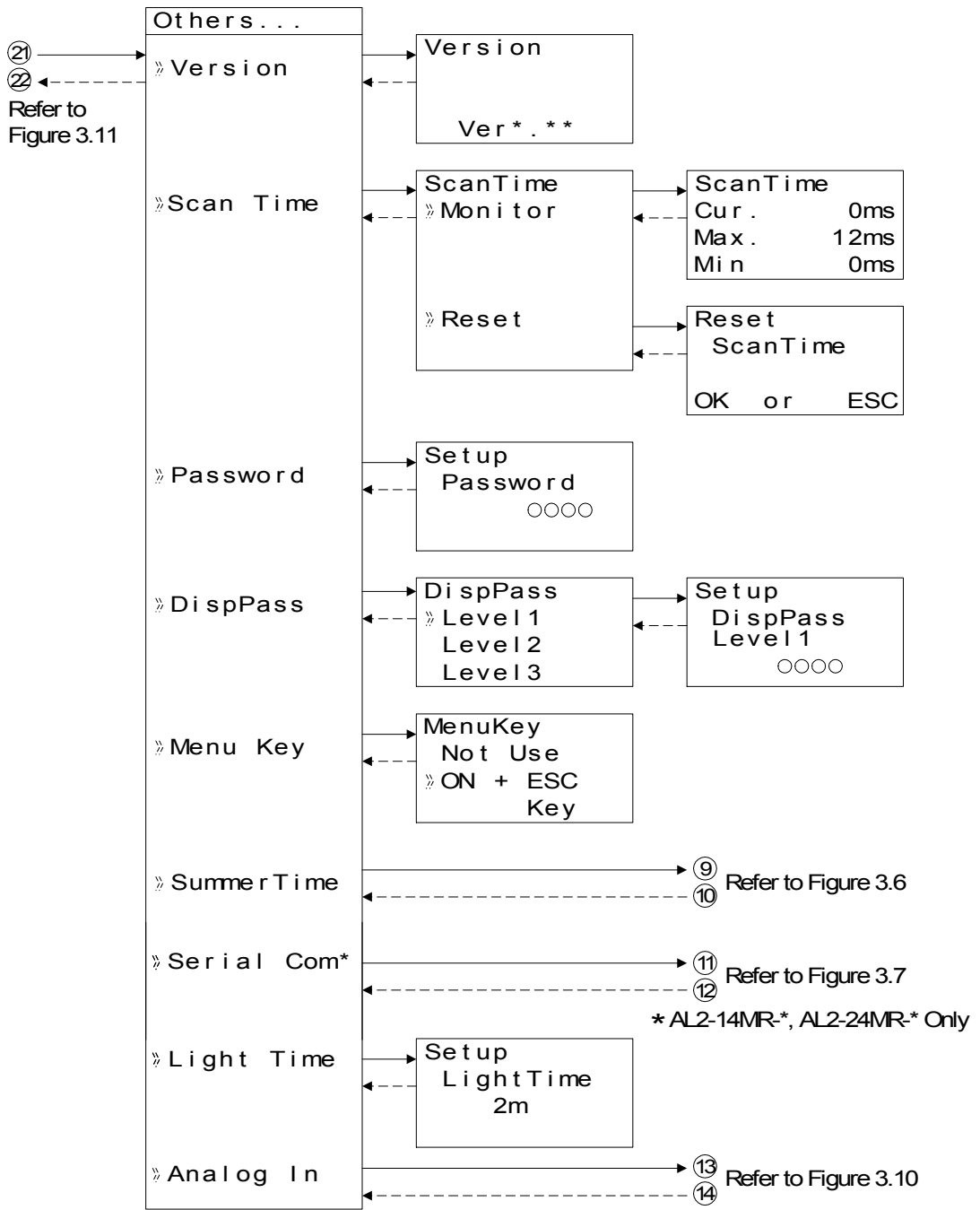

Figure 3.13: Others Menu in Run Mode Operation



### **3.4 The Edit Menu**

The Edit Menu can be entered when the α2 is in the ProgEdit or Monitor main programming screen. If entering options or connecting FBs, these procedures have to be finished or canceled before the Edit Menu can be entered. Press the “ESC” key at any place in the main programming screen to enter the Edit Menu.

- **ProgSize:**  
Shows the numbers of FBs used and percentage of program memory used.
- **Jump:**  
Leads to a screen that shows available places to go in the program. “M” - system bits; “I” - system Inputs; “O” - System Outputs; “K” - Keys (1-8); “E” - ASi Inputs; “A” - ASi Outputs; “N” - Control bits; “EI” - External Board inputs; “EO” - External Board outputs; and “B” - Function Blocks existing in the program. Choose the desired block with the arrow keys and press the “OK” key to jump to that spot in the program.
- **New FB:**  
Create a new Function Block from one of the available FBs.
- **Exit:** Exits to the Top Menu.
- **Mnemonic:**  
Gives a mnemonic display of the current programming rung. Enter the programming mode by pressing the “OK” key or return to the Edit Menu using the “ESC” key. (Not available in Monitor Mode).

### **3.5 The Function Block Edit Menu**

The Function Block Edit Menu can be entered only while in the ProgEdit or Monitor mode. Move to the Function Block to edit and press the “OK” key when the Function Block number is flashing.

- **Setup FB:**  
Set variables in the Function Blocks for your application. See Chapter 6 for more details on each Function Block’s Options. The logic functions in Chapter 5 do not have Setup Options.
- **Change No:** Change the Function Block Number
- **Delete FB:** Delete Selected Function Block

### **3.6 Option Screen Setup**

Various options have been provided for ease of use or for safety purposes. Please set as your needs require. All of the options in this section can be accessed from either the Run or the Stop Menu.

#### **3.6.1 ProgEdit**

Refer to chapter 4, Direct programming, for detailed instructions on programming the α2 Series Controller.

#### **3.6.2 Change the Language Setting**

- 1) Turn the α2 On.
- 2) Press the “OK” and “ESC” buttons simultaneously to go to the TopMenu or reset the controller.
- 3) Scroll to the “**LANGUAGE**” option and press the “OK” key. The TopMenu entry “LANGUAGE” is common for all languages.
- 4) Scroll to the desired language and press the “OK” key. The languages available are English, German, French, Italian, Spanish, Swedish, and Russian\*<sup>1</sup>.
- 5) Use the “ESC” key to exit to the Topmenu.

\*1 Ver. 3.00 or later

#### **3.6.3 ClockSET**

To set the Clock:

- 1) From the TopMenu, scroll to “**ClockSet**” and press the “OK” key.
- 2) From the options that appear, choose “**ClockSet**” and press the “OK” key.
- 3) Use the arrow keys to move to an area that needs to be changed.
- 4) Adjust with the “+” or “-” keys.
- 5) Repeat steps 3-4 until ALL changes have been completed.
- 6) Press the “OK” key to accept all the changes or the “ESC” to discards the changes.
- 7) Press the “ESC” key to return to the Top Menu.

To set the daily correction:

- 1) From the TopMenu, scroll to “**ClockSet**” and press the “OK” key.
- 2) From the options that appear, choose “**Correct**” and press the “OK” key.
- 3) Set the daily correction time with the “+” or “-” keys.
- 4) Press the “OK” key to accept the value and press the “ESC” key to return to the Top Menu.



#### **Caution**

When setting the Real Time Clock or inputting a daily clock adjustment to the following menu functions, please change the mode to Stop.

- ClockSet in ClockSet Menu
- Correct in ClockSet Menu



#### **Note:**

The date setting can be displayed as yyyy/mm/dd, dd/mm/yyyy, or mm/dd/yyyy by manipulating the “+” and “-” keys. The day of the week will update automatically as the date is changed.

### **3.6.4 RadioClock - DCF77 Decoding**

The RadioClock function enables the reception of time information broadcasted by radio signal on 77.5 kHz from Frankfurt Germany. Special hardware is required for this feature. Refer to the α2 Hardware Manual for more information. After configuring the hardware, follow the steps below to set the controller for DCF77 decoding:

- 1 ) From the TopMenu, scroll to **“ClockSet”** and press the “OK” key.
- 2 ) From the options that appear, scroll to **“RadioClock”** and press the “OK” key.
- 3 ) Only one option appears if RadioClock has not been activated. Scroll to **“RadioClock”** and press the “OK” key.
- 4 ) From the options that appear, scroll to **“DCF77”** and press the “OK” key. At this point, if the controller cannot detect a signal the message “No Signal!” will flash on the headline.
- 5 ) To select the correct analog input that carries the DCF77 time signal, scroll to **“Input No.”** and press the “OK” key. Initially **“Input No.”** will not be visible, it only appears as an option after the RadioClock function has been enabled.
- 6 ) Select the Analog Input number from I01 to I08 with the +,- keys and the “OK” key.
- 7 ) If necessary, adjust for the timezone difference between Frankfurt, Germany and the place of installation. This amount is added to (subtracted from) the received time. To do this, scroll to **“TimeDiffer”** and press the “OK” key.
- 8 ) Select the timezone difference in half hour increments using the +,- keys. Press “OK” to enter the timezone difference.
- 9 ) It is possible to manually start and stop the decoding of the time information. Scroll to **“Manual”** and press the “OK” key. Either **“Start Act.”** or **“Stop Act.”** will be displayed depending on the state of the controller at the time.



**Note:**

The **“Input No.”**, **“TimeDiffer”** and **“Manual”** selections will only be displayed when **“DCF77”** has been enabled from the **“RadioClock”** menu.



The error message **“No Signal!”** will flash on the headline if the controller does not receive the DCF77 signal when the input is setup for the RadioClock function. If there should be a signal in the installation area, check the setup and hardware for faults.



When in STOP mode and **“Start Act.”** is used to manually start DCF77 decoding, the user must check the state of M10 (decoding active flag) 30 minutes after starting the decoding. If M10 is off, DCF77 decoding finished without error. If M10 is still ON, there is a problem with either the wiring or the availability of the signal in the location of use (e.g. antenna problems). The user should check both possible causes.

### 3.6.5 SummerTime

The Summertime menu will display six choices when entered.

Cancel - Turns off the Summertime clock setting.

Manual On - Moves the clock one hour ahead immediately and will remain ON until cancelled.

Date Type - Set the On date, Off date, and Time adjustment.

UK Type - Last Sunday of March to the last Sunday of October.

US Type - First Sunday of April to the last Sunday of October.

EU Type - Last Sunday of March to the last Sunday of October.

Free Type - Set the On/Off date among each Sundays, Hour of time change, and Adjust time.

The time changes for the UK timezone take place at 1:00 AM in the Spring and 2:00 AM in the Autumn. Time changes in the US and EU setting take place at 2:00 AM in the Spring and 3:00 AM in the Autumn.

If the controller time has been adjusted for Summertime, an “s” will precede the hour number on the display screen.

#### Setting the controller for Summertime operation:

- 1) From the TopMenu, scroll to “Others...” and press the “OK” key.
- 2) From the options that appear, scroll to “Summertime” and press the “OK” key.
- 3) Scroll to the desired setting (see above for information on settings).
- 4) Press the “OK” key to accept the setting.
- 5) If the display time has been adjusted, an “s” will precede the hour number on the display screen. If the date is outside of the “summertime” range, no visible sign will appear.

Figure 3.14: Changeover Date and Time

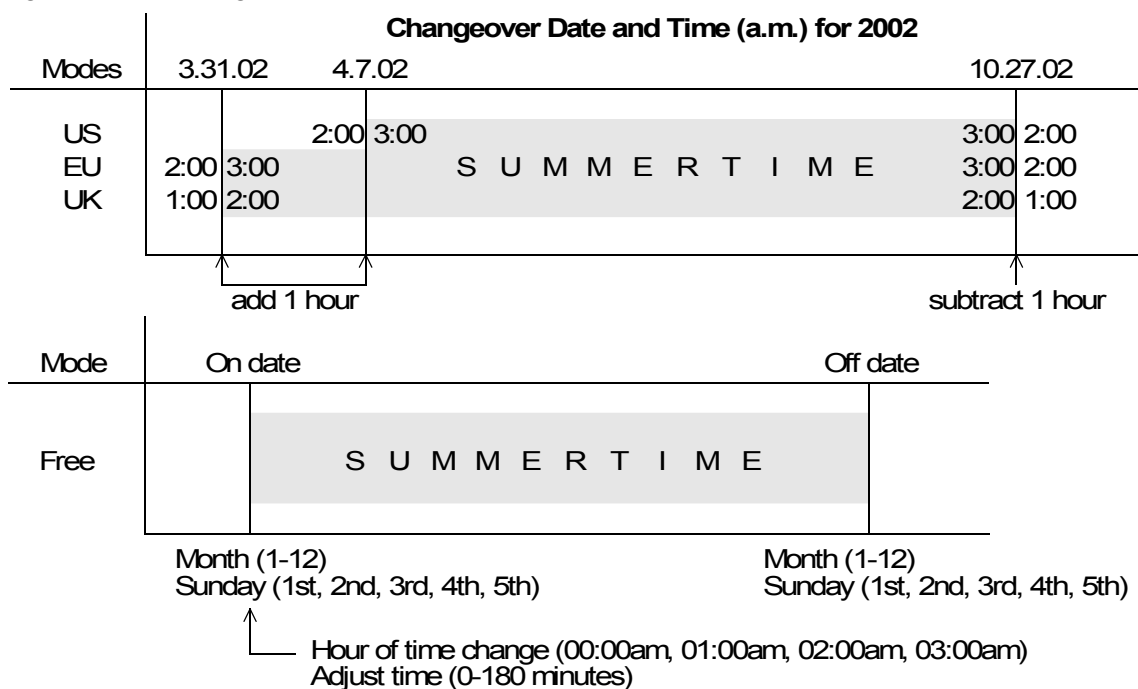

**Note:**

When Summertime is in effect, the clock should not be set to the changeover time. For example, the clock should not be set to 2:00 a.m. on March 7, 2002 when US Summertime is enabled. There will be an error in the displayed time.

### 3.6.6 DispPass

DispPass provides the α2 Series Controller with three distinct security levels, limiting the users' ability to make changes to program parameters (i.e. the SetPeriod parameter of the SpeedDetect FB). A non-authorized user will be able to navigate the display screen from field to field, but will not be able to make changes without, first, entering the appropriate password. There are three passwords that can be set from the front panel or the VLS software. Each password can control access to many different displayed parameters.

The security level for a displayed parameter must be assigned with the VLS software but, the actual password can be set, changed or removed with the front panel keys. The following is the step-by-step process for modifying password settings.

To set the Level 1, Level 2 or Level 3 Password:

- 1) From the TopMenu, scroll to **“Others...”** and press the **“OK”** key.
- 2) From the options that appear, scroll to **“DispPass”** and press the **“OK”** key.
- 3) Select **“Level 1”**, **“Level 2”** or **“Level 3”**
- 4) Enter the Password with the **+**, **-** and directional buttons.
- 5) Press **OK** to activate the password.

To remove the Level 1, Level 2 or Level 3 passwords:

- 1) From the TopMenu, scroll to **“Others...”** and press the **“OK”** key.
- 2) From the options that appear, scroll to **“DispPass”** and press the **“OK”** key.
- 3) Select a security level with a key icon by it.
- 4) Enter the appropriate level Password with the **+**, **-** and directional buttons.
- 5) Press **OK** to deactivate the password.

To change a password:

To change a password perform the **“To remove the Level 1, Level2 or Level 3 Passwords”** procedure then the **“To set the Level 1, Level 2 or Level 3 Passwords”** procedure from above.

The example window below shows how to assign a password to a function block parameter being displayed on the front panel. In this example, the SpeedDetect function block has been used.

- 1) Select the parameter that will be displayed, in this example, SetPeriod.
- 2) Select the security level.
- 3) Assign the password in the Password Dialog Box.

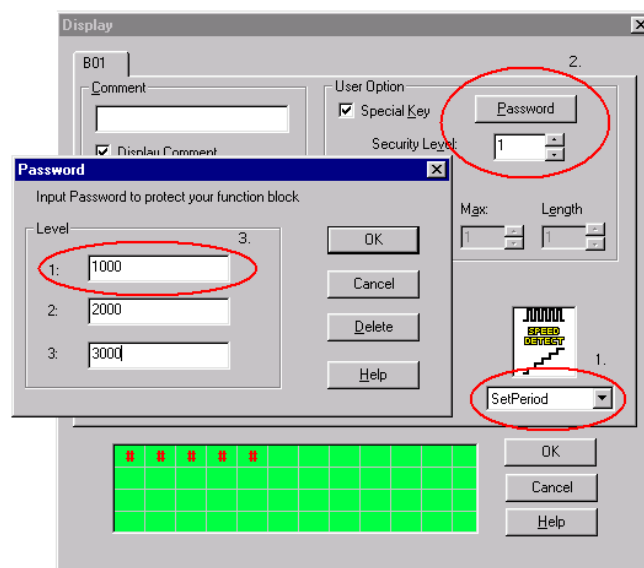

### **3.6.7 Password**

The password consists of four digits and will prohibit entry into the ProgEdit, Monitor, Disp Pass and Serial Com modes only. All other menu options can be accessed when a Password is used.

#### **To Enter a Password:**

- 1) Select **“Others...”** Menu Option.
- 2) Select **“Password”** from the “Others...” Menu Options
- 3) Use the “+” and “-” keys to enter the desired password.
- 4) Press the “OK” key to accept and activate the password.
- 5) A key symbol will now be displayed at the top of the α2 display.

#### **To Cancel a Password:**

- 1) Select the **“Others...”** Menu Option.
- 2) Select **“Password”** from the “Other” Menu Options. “Cancel Password” should appear on the top of the screen.
- 3) Use the “+” and “-” keys to enter the current password.
- 4) Press the “OK” key to accept and deactivate the password.
- 5) The key symbol will be removed from the α2 display.

Note 1: A Password protected program in an AL2-EEPROM-2 Cassette can be run from and be downloaded into the main body of the controller.

Note 2: A controller containing a Password protected program can accept or transfer programs to an AL2-EEPROM-2.

Note 3: The Password can also be set/deleted from the AL-PCS/WIN-E software or deleted by the “PROGCLEAR” command.

### **3.6.8 Enhanced User Program Protection (Version 2.20 or later)**

Besides the existing user program password protection two new kinds of user program protection are established.

- Program Read Protection
- Copy Program To Memory Cassette Protection

#### 1) Program Read Protection

The Program Read Protection prohibits any kind of read access to the user program in an α2 (Version 2.20 or later).

This protection can be set only in VLS by downloading a user program with a 5 digit user program password set, '1' as the first digit.(“1\*\*\*\*”:10000 to 19999)

When the protection is set, the program password can't be changed at α2 by soft key operation.

The program read protection is reset, when the controller content is erased (VLS or α2) or an unprotected user program (program read protection not set) is downloaded by VLS.

This protection doesn't work in older α2 (FW version 1.00 and 2.14), but it is also not reset in those controllers, thus it is inherited in case of copying by VLS or memory cassette to another α2.

When the program read protection is set, it's also not possible to upload a user program with an older version of VLS.

Copying the user program to a memory cassette is also prohibited, when the protection is set.





**Note:**

When the program read protection function is used and the password is forgotten, the program can't be recovered by any methods. So, please take care to handle the function.

The following table shows the possible and prohibited actions in case the Program Read Protection is set.

Action		Comment	
VLS	Program Download (VLS to α2)	✓	
	Program Upload (α2 to VLS)	-	
	Monitoring	✓	For monitoring the program must be exists in the PC that runs VLS for monitoring, thus the user program can be seen anyway.
	Switch RUN/STOP	✓	
	Program Parameter Change	✓	
	Controller Contents Clear	✓	
	Download New/Same User Program	✓	
	Reset Flag in α2 controller	-	
α2	Read Program Name	✓	
	Program Erase	✓	
	Programming by α2 Display and Soft Keys	-	Program can be read out (except display manager contents) by α2 display.
	Monitoring	-	Program can be read out (except display manager contents) by α2 display.
Others	Program Parameter Change	(✓)	As long a for program parameter change the monitoring display isn't used, the program parameter can be changed.
	Copy to memory cassette	-	
	Dedicated Communication	✓	

✓ : Action is possible , - : Action is not possible

2) Copy Program To Memory Cassette Protection

The Copy Program To Memory Cassette Protection prohibits copying of an α2 user program from main body memory to a memory cassette.

This flag doesn't work in older α2(FW version 1.00 and 2.14), but it is also not reset in those controllers, thus it is inherited in case of copying by VLS or memory cassette to another α2.

- Password  
0000 to 9999(Four digits)
- Program Read Protection  
10000 to 19999(Five digits)

Memory Cassette Protection

Password

Input Password to Protect your Program.

\*\*\*\*\*

Copy to Memory Cassette Protection

### **3.6.9 Serial Com**

The modem function capability of the α2 allows remote monitoring via a PC and program upload/download. The communication must take place using Visual Logic Software (VLS) and the communication must be initiated accordingly. (The modem connected to the α2 is initialized upon the α2 start-up. Dialing options from a command or specific conditions are not available).

**Command** - Enter the AT command for the modem to be connected to the controller. Reference the Modem User manual for details on that unit's AT command. Choose the first letter or symbol by using the (▲) and (▼) arrows. When the symbol is showing in the command line, use the (◀) and (▶) arrows to move to adjoining spaces. Enter up to 64 letters/symbols and accept the whole string with the "OK" key when finished inputting the data. (There is no need to accept each letter with the "OK" key).

**Delay** - The Delay function sets the length of time the α2 will wait after power on before setting the setup AT command to the modem. Choose a value of 0 - 10 seconds using the "+" or "-" keys. The modem connected to the Personal Computer with VLS software must be set ON prior to the α2 modem turning on.

The GSM function allows a SMS (Short Message Service) message to be sent to either a mobile telephone or an email account. The short message provides the remote user with the identical LCD screen's data. By receiving a short message by α2, SMR FB bit output or word output can be changed this remote switch commands carried out. Refer to the α2 Communication Manual for detailed explanation concerning GSM parameters.

The OtherCom function provides the user with an on-line programming feature using dedicated protocol. Refer to the α2 Communication Manual for detailed explanation concerning Dedicated Protocol parameters.

### **3.6.10 Memory cassette**

**The Memory Cassette EEPROM is the active memory whenever it is properly installed in the α2 controller. The controller must be powered down before installing/removing the memory cassette or an error will occur.**

#### **To Verify a Program:**

- 1 ) Install the AL2-EEPROM-2. Refer to the AL2-EEPROM-2 instruction manual for help.
- 2 ) Select **"Others..."** in the Top Menu.
- 3 ) Select **"ProgTran."**
- 4 ) Select **"Verify"**.
- 5 ) Choose "OK" to proceed or "ESC" to exit.
- 6 ) If the program is successfully verified, the work "Completed" will blink on screen.
- 7 ) If the programs are not the same, the words "Verify Error" will blink onscreen.

#### **To Transfer a Program from the Cassette to the α2:**

- 1 ) Install the AL2-EEPROM-2. Refer to the AL2-EEPROM-2 instruction manual for help.
- 2 ) Select **"Others..."** in the Top Menu.
- 3 ) Select **"ProgTran."**
- 4 ) Select **"Cassette→"**.
- 5 ) Choose "OK" to proceed or "ESC" to exit.
- 6 ) When the program is successfully transferred, "Completed" will blink on the display.

#### **To Transfer a Program from the α2 to the Cassette:**

- 1 ) Install the AL2-EEPROM-2. Refer to the AL2-EEPROM-2 instruction manual.
- 2 ) Select **"Others..."** in the Top Menu.
- 3 ) Select **"ProgTran."**
- 4 ) Select **"Cassette←"**.
- 5 ) Choose "OK" to proceed or "ESC" to exit.
- 6 ) When the program is successfully transferred, "Completed" will blink on the display.

#### **To apply the "ProtectSW" Feature:**

The "ProtectSW" will write protect the program in the memory cassette. The program cannot be edited nor erased when the feature is ON.

- 1 ) Install the AL2-EEPROM-2 per the instruction manual.
- 2 ) Select **"Others..."** in the Top Menu.
- 3 ) Select **"ProgTran."**
- 4 ) Select **"ProtectSW"**.
- 5 ) Choose "On" to activate the feature.

#### **To Remove the "ProtectSW" Feature:**

- 1 ) Install the AL2-EEPROM-2. Refer to the AL2-EEPROM-2 instruction manual.
- 2 ) Select **"Others..."** in the Top Menu.
- 3 ) Select **"ProgTran."**
- 4 ) Select **"ProtectSW"**.
- 5 ) Choose "Off" to de-activate the feature.

In case of an α2 version 2.20 controllers in VLS programming software the "Copy to Memory Cassette protection" can be set. If this option is set, the copy of a program from α2 version 2.20 controller to Memory cassette is prohibited.

### **3.6.11 Analog Inputs**

The Analog Inputs can be configured for three different modes: Normal, TC and PT100. Normal mode is used for ordinary analog signals. TC and PT100 modes should be used with the AL2-2TC-ADP and AL2-2PT-ADP modules respectively. For more information on these modules, refer to the *α2 Hardware Manuals* and the individual installation manuals. The following changes should be made in the Stop mode. Only the “OffsetFine” adjust works in both RUN and STOP modes.

#### **To Set/Change the modes of the Analog Inputs (Stop Mode only):**

- 1 ) Select “Others...” from the TopMenu while in Stop Mode.
- 2 ) Select “Analog In.”
- 3 ) Choose the appropriate input and press OK.
- 4 ) “Mode” will be the only option displayed if the analog input was previously set on “Normal.” Select “Mode” by pressing the OK button. Then, select the appropriate mode setting. “Calibrate” and “OffsetFine” should appear on the Analog Input settings menu.

#### **Offset Calibration of the PT 100 and TC inputs (Stop Mode only):**

- 1 ) Before beginning, follow the instructions on preparing the hardware for calibration in the *α2 Hardware Manual*, Chapter 12 for the PT100 input and Chapter 13 for the TC input.
- 2 ) Select “Others...” from the TopMenu while in Stop Mode.
- 3 ) After setting the mode to TC or PT100 (See the method for changing modes in the previous description.), select “Calibrate” from the Analog input settings menu.
- 4 ) Select -50°C and press OK. This completes the offset calibration procedure.

#### **Gain Calibration of the PT100 and TC inputs (Stop Mode only):**

- 1 ) Before beginning, follow the instructions on preparing the hardware for gain calibration in the *α2 Hardware Manual*, Chapter 12 for the PT100 input and Chapter 13 for the TC input.
- 2 ) Select “Others...” from the TopMenu while in Stop Mode.
- 3 ) After setting the mode to TC or PT100 (See the method for changing modes in the previous description.), select “Calibrate” from the Analog input settings menu.
- 4 ) Select 200°C for the PT100 input or 450°C for the TC input and press OK. This completes the gain calibration procedure.

#### **Fine Adjust for the Offset:**

- 1 ) Select “Others...” from the TopMenu either in Stop or Run Mode.
- 2 ) After setting the mode to TC or PT100, select “OffsetFine” from the Analog input settings menu.
- 3 ) “OffsetFine” can be adjusted while in Run or Stop Mode. Use the + and - buttons to select the appropriate offset value.



**Note:**

The fine adjust step size for the PT100 mode is 0.5°C and 1.0°C for the TC mode. The Fahrenheit step sizes are 0.9°F and 1.8°F respectively.

**To change the temperature scale setting (Stop Mode only):**

- 1 ) Select "Others..." from the TopMenu while in Stop Mode.
- 2 ) Select "Analog In."
- 3 ) Select "TempScale."
- 4 ) Select "Celsius" or "Fahrenheit."



**Note:**

In Run Mode, the temperature scale can be checked but cannot be changed.



**Note:**

System flags, M17 through M24, correspond to the 8 possible temperature input channels, I01 through I08. When the analog input is configured for TC or PT100 input, these system flags will detect a defect in the ADP module's operation. An input voltage of more than 11 volts will set the corresponding flag and indicates a sensor problem. An input voltage of 0 volts will also set the corresponding flag, but indicates a power failure at the ADP module.

### **3.7 LCD Displays**

There are a number of types of data and/or information that can be displayed on the LCD display besides the menus listed previously.

#### **3.7.1 Image Table**

The first LCD display to appear is the Input/Output image table and the Real Time Clock. The clock shows the current time as set by the user. The Summertime mode is shown by an "s" preceding the time if activated.

#### **3.7.2 LCD Function**

Display up to 12 different letters or characters on each of four lines. Options include character strings (design your own message), function block data, or analog data.

## **3.8 Block Items**

Each block item contains an individual diagram that shows the block number, available number of input pins, the output pin if applicable, and the block mnemonic. Connections between blocks can be viewed at the pin locations when connected blocks are shown individually on the LCD.

### **3.8.1 Input Blocks**

The Input Blocks consist of System Inputs (I01 - I15), Key Inputs (K01-K08), System Bits (M01-M24) or Link Inputs (E01 - E04). The input number is shown in the top right hand corner, the type of input in the lower right hand corner, and the output pin is shown on the far right of the block. Input Blocks provide information to the Function Blocks or Outputs.

### **3.8.2 Function Blocks**

The individual Function Blocks are described in detail in Chapters 5 and 6. Function Blocks can have 0 to 4 input pins shown on the left of the diagram and an output shown on the far right. Some function blocks have data that can be used for comparison purposes only or are used to display data onscreen. These blocks have no output pins. The number and block mnemonic are shown in the top right and bottom right locations respectively.

### **3.8.3 Output Blocks**

Output Blocks have one input and one output pin. They only have the capacity for one input signal through the input pin. The Output Block number and Mnemonic are shown in the top right and lower right hand corner of the diagram respectively.

### **3.8.4 Connected Blocks**

Blocks that are connected can be shown simultaneously onscreen. The block providing the output signal will be shown on the left of the screen. The input pin accepting the signal will flash. Any input pin that is already connected will be shown as a solid triangle.

## 4. Direct Programming

The α2 can be programmed using the front panel keys on the α2 series controller. The following sections will describe how to connect/disconnect function blocks, set program parameters, add Function Blocks, and move around within the program.

The ProgEdit mode in the Stop Menu has full programming capability. The Monitor mode in the Run Menu has the capability to manipulate Function Block values and settings but cannot edit, change, or delete the existing program.

### 4.1 Block Availability

The number of System Inputs and Outputs is determined by the type of controller being programmed. Configurations include 6 In/4 Out, 8 In/6 Out and 15 In/9 Out. Up to 200 Function Blocks can be used in a program or 5000 bytes of memory. The Function Blocks must be added in the course of programming. The 8 Keys and the 24 system M bits are automatically available for every program.

Inputs, Outputs, System Memory Bits, Extended Inputs, Extended Outputs, AS-i Outputs, Control Bits, and Keys do not count in the Function Block total.

### 4.2 Connecting Blocks



Any block that has an output pin can be connected to any block that has an (unused) input pin. System Inputs, Keys, and Memory M bits have output pins only.

Function Blocks and Outputs both contain input and output pins (the Display and TimeSwitch Blocks are exceptions). Blocks can be connected beginning with an output pin, from “left to right” on the display, or beginning with an input pin, from “right to left” on the display.

#### 4.2.1 To connect the blocks from the left (signal provider) block to right (signal receiver) block.

It is necessary to choose the block to provide the output (step 1), the block to accept the signal (step 2), and the pin with which to accept the signal (step 3).

- 1 ) Step 1: Select the block providing the data to be output and move to the right until the output pin is flashing. Press the “+” button to “add” a block.

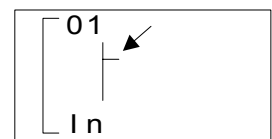

- 2 ) Step 2: Choices will appear on the right side of the screen that include System Outputs (if available), existing Function Blocks that have free input pins, and the option to add a new function block (AddFB, see section 4.4). Scroll to the preferred option and select using the “OK” key.

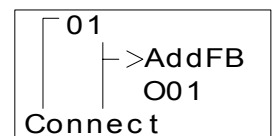

- 3 ) Step 3: The block accepting the signal will display as many of its input pins as possible (at times they will not all fit on-screen). Pins that have been used will show as filled triangles; pins that are open will show as ">" signs. A "Connect" prompt will appear on-screen, either above or below the left hand block. The current input choice will flash. Scroll to the desired pin and press the "OK" key to accept. The process is complete.

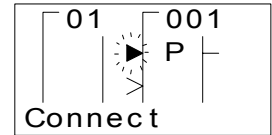

**4.2.2 To connect the blocks from the right (signal receiver) block to left (signal provider) block.**

It is necessary to choose the block input pin (Step 1), the signal provider (Step 2), and to accept the connection (Step 3).

- 1 ) Step 1: Select the block that will be receiving the signal and move left until an input pin is flashing. Scroll to the desired unused input pin (">"). Press the "+" key to begin the connection process.

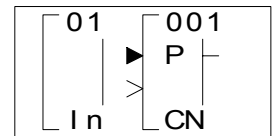

- 2 ) Step 2: Because output pins may have multiple connections, all the Keys, Function Blocks, System Inputs, Outputs will show on the left of the screen as well as an option to "AddFB". Scroll to the preferred option and Press the "OK" key.

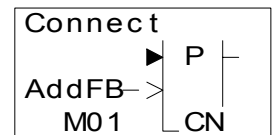

- 3 ) Step 3: The chosen connection will be flashing on-screen along with the "Connect" prompt. Press the "OK" key to accept.

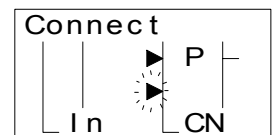

**4.3 Disconnect Two Blocks**

Blocks can be disconnected by implementing the following procedure. Move to the connection that is to be disconnected. Enter "-" as the disconnect command. A "Disconnect" prompt will appear on-screen. Press the "OK" key to accept the disconnect.



## 4.4 Methods to Create a Function Block

The two methods of creating a Function Block. The New FB option in the Edit Menu and AddFB option when connecting two blocks.

### 4.4.1 New FB



To use the New FB option, proceed to the Edit Menu (Chapter 3) using the “ESC” key. Scroll to the New FB option and press the “OK” key. Scroll to the desired Function Block and press the “OK” key to create a New FB. The block will appear on the Function Block Diagram board.

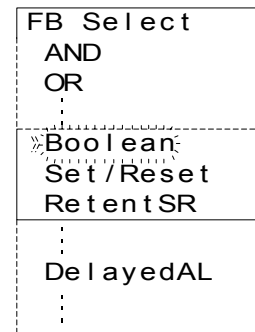

### 4.4.2 AddFB

When connecting a Function Block, scroll to the AddFB prompt and press the “OK” key. This invokes the Function Block list. Scroll to the desired Function Block and choose by pressing the “OK” key. The Function Block will be shown on the screen with the connecting block.

## 4.5 Function Block Editing

To enter the Function Block editing menu (Chapter 3), press the “OK” key when the Function Block number and name are flashing on the screen. Up to three options appear on-screen: Setup FB, Change No, and Delete FB. The Setup Function option is not valid for some Function blocks and so will not always appear and certain function blocks will also contain a Time unit option (refer to chapter 6 for function block specification).

### 4.5.1 Setup Function Block



Each Function Block has its own individual parameters outlined in Chapter 6. The Function Blocks might have multiple data screens that can be altered. As with other menu options, the “ESC” key will move the screen back to a higher menu option without changing the option parameters for that screen. If there are multiple data screens in an option, enter the required data and accept each screen using the “OK” key. Use the “ESC” key to exit the Function Block.

### 4.5.2 Change No. (of a Function Block)

Change the number of an existing Function Block with this screen. The current FB number is shown on-screen when the option is selected. Scroll up or down with the “+” or “-” keys to find an open FB number. Press the “OK” key to accept the new number.

### 4.5.3 Delete FB

This menu option will Delete the current Function Block. After the Delete FB is chosen, confirm the delete operation with “OK” or use the “ESC” key to cancel the function. All connections to the Function Block will be removed with the block.

## 4.6 Movement between Function Blocks

There are a number of ways to move from one item to another when in the ProgEdit or Monitor modes.

### 4.6.1 Movement Between Unconnected Blocks



Movement between System Inputs, System Outputs, Keys, and M bits can be accomplished with the “+” and “-” keys. When the block number is flashing on-screen, press the “+” key to scroll to the higher value of the same block type; e.g. move from I01 to I02 to I03...until the highest value is reached. The scroll will then proceed to the lowest value of the next block type. The same technique will work for the “-” key in the opposite direction.

Function Blocks can be scrolled through in the same manner, although only the Function Blocks are rotated through in this case.

### 4.6.2 Movement Between Connected Blocks

The Right arrow moves horizontally (to the right) along the path of connections between blocks. If an output pin is connected to multiple input pins, the current path will flash. The Up and Down arrows can be used to choose the desired path. The left arrow will move back along the path of the connections to the left.

### 4.6.3 The Jump Command

The “ESC” key can be used to enter the Edit Menu at anytime when a function block is displayed on the LCD screen. (The “ESC” key will cancel in-process commands first. Keep pressing the “ESC” key until the Edit Menu is displayed). Select the Jump Command. Choose any system Memory Bit, Input, Output, Key, AS-i Input, AS-i Output, Extended Input, Extended Output, or existing Function Block by using the front panel keys. Press “OK” to “Jump” to the chosen block in the programming mode.

Ed i t Menu
ProgSize
» Jump
New FB
Ex i t
Mnemon i c

## 4.7 Using Keys as Inputs

Connect the Keys for use as Manual Inputs by using the Jump command to access the desired key, by connecting a Function Block or Output as described in Chapter 3, or by scrolling through the blocks as described in section 4.6.1.

The programmed Key(s) will give an output signal for as long as the key is depressed.

### 4.8 The Monitor Mode

Function Block values and Output status can be manipulated from the Monitor option. When placed in the Run mode, the α2 defaults back to the I/O status screen. Press the “ESC and OK” keys together to enter the Top Menu and then enter Monitor. The program will now be displayed on-screen. Movement among the function blocks is the same as in the ProgEdit mode.

#### 4.8.1 Monitor/Update Function Block Values



Move to the function block to monitor and enter Setup FB. The Function Block Values can be updated and monitored. Changes to current values will be valid only while in the Monitor Mode. Changes to Set point data and the comparison values will be written to the system memory.

Type	Abbreviated Terms	Forcing Conditions
Input	I	1
	EI	1
	E	2
Output	O	2
	E0	2
	A	2
Key	K	3
System bit	M	3
Control bit	N	2
Function Block	B	3

- 1 ) It is possible to force ON/OFF, however, the status is decided by hardware control.
- 2 ) It is possible to force ON/OFF, however, the status is decided by programming control.
- 3 ) It is possible to force ON/OFF. Only some FB, however, the status is decided by programming control.

### 4.8.2 Forcing Outputs ON/OFF

Outputs can be forced ON/OFF if there is no direct conflict with the program. To force an Output On, proceed to the position where the Output name and number are flashing and press the “OK” key. A solid rectangle will appear underneath the block number to signify that the block is ON.

Input pins will have a smaller solid block next to their arrow to show that they are activated. In the block at right, the Delay output pins are ON, along with the input and output pins for the system Output O01.

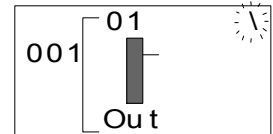

An example of a block that cannot be forced follows.

Ex. Output O01 is connected to System Bit M01. M01 is constantly ON, therefore Output O01 is constantly ON and cannot be forced OFF.

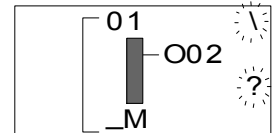

### 4.8.3 Add/Delete Function Blocks in the Monitor Mode

The user cannot Add or Delete Function Blocks while in the Monitor mode.

## 5. The Logic Function Blocks

Logic Function Blocks operate by reading whether signals are ON or OFF and then setting the status of their Outputs accordingly. There are six types of logic blocks available in the α2 Series - AND, OR, NAND, NOT, NOR, XOR. Analog signals cannot be processed by the Logic blocks. In this chapter, each Function Block has a description, a diagram of the Function Block as seen on the LCD Display, and a logic table to show how the Output is controlled by the input signals.

Table 5.1: Boolean Logic function blocks



Logic Block State	Logic Block Displayed	Description	Memory Use	Section Reference
AND		This function executes logical AND operation on given input signals. The input signals connected should be of bit input type only. 4 Bit input pins and 1 Bit output pin. If all the inputs are ON then the output is ON, otherwise output is OFF.	19 Byte	5.1
OR		This function executes logical OR operation on given input signals. The input signals connected should be of bit input type only. 4 Bit input pins and 1 Bit output pin. If all the inputs are OFF then output is OFF, otherwise output is ON.	19 Byte	5.2
NOT		This function executes logical NOT operation on given input signal. The input signal connected should be of bit input type only. 1 Bit input pin and 1 Bit output pin. Output is negation of Input given.	10 Byte	5.3
XOR		This function executes logical XOR operation on given input signals. The input signals connected should be of bit input type only. 2 Bit input pins and 1 Bit output pin. If both the inputs are either OFF or ON then output is OFF, otherwise output is ON	13 Byte	5.4
NAND		This function executes logical NAND operation on given input signals. The input signals connected should be of bit input type only. 4 Bit input pins and 1 Bit output pin. If all the inputs are ON then output is OFF, otherwise output is ON	19 Byte	5.5
NOR		This function executes logical NOR operation on given input signals. The input signals connected should be of bit input type only. 4 Bit input pins and 1 Bit output pin. If all the inputs are OFF then output is ON, otherwise output is OFF	19 Byte	5.6

The logic FB have no parameters.

### 5.1 The AND Block

The AND block comes ON when all the inputs are ON.  
 Any Input that is OFF will keep the Output turned OFF.  
 Unused inputs are considered to be ON.  
 If no Input pins are connected, the block output is OFF.

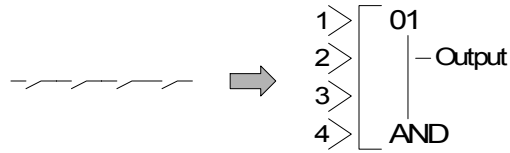
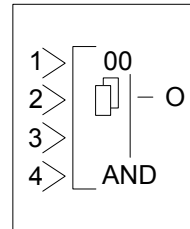

Table 5.2: AND Logic gate

Input 1	Input 2	Input 3	Input 4	Output
On	On	On	On	On
On	On	On	Off	Off
On	On	Off	On	Off
On	Off	On	On	Off
Off	On	On	On	Off
On	On	Off	Off	Off
On	Off	Off	On	Off
Off	Off	On	On	Off
Off	On	On	Off	Off
On	Off	On	Off	Off
Off	On	Off	On	Off
On	Off	Off	Off	Off
Off	On	Off	Off	Off
Off	Off	On	Off	Off
Off	Off	Off	On	Off
Off	Off	Off	Off	Off

## 5.2 The OR Block

The Output comes ON when any input is ON.

The Output remains OFF only if all the inputs are OFF.

Unused Inputs are considered to be OFF

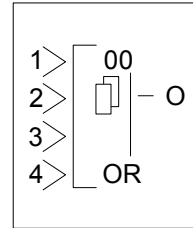
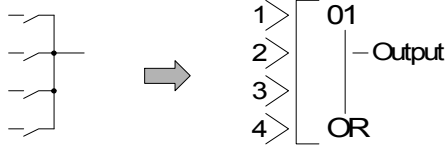

Table 5.3: OR Logic gate

Input 1	Input 2	Input 3	Input 4	Output
On	On	On	On	On
On	On	On	Off	On
On	On	Off	On	On
On	Off	On	On	On
Off	On	On	On	On
On	On	Off	Off	On
On	Off	On	Off	On
On	Off	Off	On	On
Off	On	On	Off	On
Off	On	Off	On	On
Off	Off	On	On	On
On	Off	Off	Off	On
Off	On	Off	Off	On
Off	Off	On	Off	On
Off	Off	Off	On	On
Off	Off	Off	Off	Off

### 5.3 The NOT Block

The NOT block takes a signal and inverts it - an Input that is ON has an Output that is OFF, and vice versa.  
 The Output comes ON when the input is OFF.  
 The Output is OFF when the input is ON.  
 If no Input pin is used, the block output is OFF.  
 The electrical circuit for a NOT block is the same as a Normally Closed input.

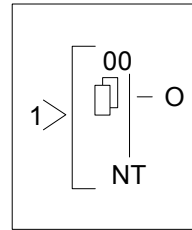

Table 5.4: NOT Logic gate

Input	Output
On	Off
Off	On

### 5.4 The XOR Block (Exclusive OR)

The Output comes ON when one input is ON and one is OFF. The Output remains OFF when both Inputs are equivalent (either both ON or both OFF).  
 Unused Inputs are considered to be OFF.

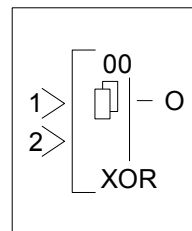

Table 5.5: XOR Logic gate

Input 1	Input 2	Output
On	On	Off
On	Off	On
Off	On	On
Off	Off	Off



### 5.5 The NAND Block (Not AND)

The Output comes ON if any or all inputs are OFF.

If every input is ON, the Output turns OFF.

Unused Inputs are considered to be ON.

If no Input pin is used, the block output is OFF.

(This is equivalent to an AND block followed by a NOT block)

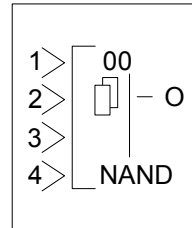
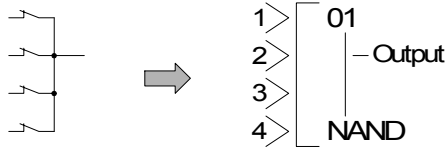

Table 5.6: NAND Logic gate

Input 1	Input 2	Input 3	Input 4	Output
On	On	On	On	Off
Off	Off	Off	Off	On
On	On	On	Off	On
On	On	Off	On	On
On	Off	On	On	On
Off	On	On	On	On
On	On	Off	Off	On
On	Off	On	Off	On
On	Off	Off	On	On
Off	On	On	Off	On
Off	On	Off	On	On
Off	Off	On	On	On
On	Off	Off	Off	On
Off	On	Off	Off	On
Off	Off	On	Off	On
Off	Off	Off	On	On

### 5.6 The NOR Block (Not OR)

The Output comes ON when all the inputs are OFF.  
 The Output remains OFF if any input is ON.  
 If no Input pin is used, the block output is OFF.  
 Unused Inputs are considered to be OFF  
 This block is equivalent to an OR block followed by a NOT block

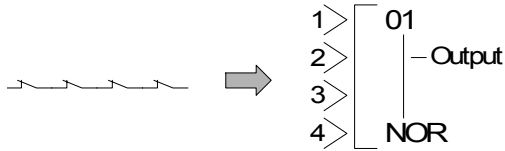
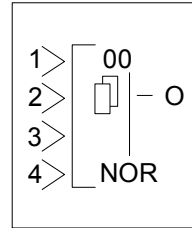

Table: 5.7: NOR Logic gate

Input 1	Input 2	Input 3	Input 4	Output
Off	Off	Off	Off	On
On	On	On	On	Off
On	On	On	Off	Off
On	On	Off	On	Off
On	Off	On	On	Off
Off	On	On	On	Off
On	On	Off	Off	Off
On	Off	On	Off	Off
On	Off	Off	On	Off
Off	On	On	Off	Off
Off	On	Off	On	Off
Off	Off	On	On	Off
On	Off	Off	Off	Off
Off	On	Off	Off	Off
Off	Off	On	Off	Off
Off	Off	Off	On	Off

## 6. Function Blocks

The α2 series controller is fundamentally based on function block programming. The blocks provide a wide range of possible operations and have been preprogrammed for ease of use. Some Function Blocks have parameters that can be tailored to meet individual requirements in the programs. Each function block will have a description of the Block's purpose, a diagram of how the Block will appear on-screen, and a description of the inputs, outputs, and available options.

**Table 6.1.1: Function Block List**

FB Name	FB Symbol	Description of Function Block	Memory Use	Section
Boolean [BL]		The Boolean Function Block uses Boolean algebra to control the ON/OFF state of an output. An operational expression consists of either the AND, OR, XOR or NOT form.	*1	6.3
Set/Reset [SR]		The Set/Reset Function Block either holds an output ON (set) or releases the output OFF (reset.) Priority can be given to either input pin if both inputs have been energised simultaneously. The default priority setting is dedicated to the reset input pin.	14 Byte	6.4
Pulse [PL]		The Pulse Function Block sends a single pulse to the output pin if the input pin receives either an "ON to OFF", "OFF to ON" or "ON to OFF And OFF to ON" input operation.	10 Byte	6.5
Alternate [AL]		The Alternate Function Block is used to reverse the ON and OFF state of the output as and when the input pin receives a signal. The output will be set ON when the input pin goes high and remain ON until the input receives the second rising edge.	13 Byte	6.6
Delay [DL]		The Delay Function Block provides an ON delay timer and an OFF delay timer. Time intervals for either situation can be set. The time unit can be set to 10ms, 100ms or 1s increments.	19 Byte	6.7
One Shot [OS]		The One Shot Function Block awaits a signal supplied to the input pin thereafter setting the output according to the specified time. The timing parameters control the state of the output (depending on the priority setting). The time unit can be set to 10ms, 100ms or 1s increments.	17 Byte	6.8
Flicker [FL]		The Flicker Function Block changes the ON and OFF state of the output according to a preset flicker time. The time unit can be set to 10ms, 100ms or 1s increments.	19 Byte	6.9

FB Name	FB Symbol	Description of Function Block	Memory Use	Section
Time Switch [TS]		The Time Switch Function Block uses a predefined time schedule to control the ON and OFF status of the output.	*2	6.10
Time Switch m [TSm]		The Time Switch maintenance Function Block uses a predefined time schedule to control the ON and OFF status of the output. The function block can be setup from the TopMenu "Parameter" via the front panel keys.	*2	6.10
Counter [CN]		The Counter Function Block increments the current value by one as and when the input pin receives a signal. When the current value reaches the set value the output is set ON. The counter current value is reset as and when the clear pin receives an input.	16 Byte	6.11
U/D Counter [UD]		The Up/Down Function block positively or negatively increments the counter until a set value is reached thereby setting the output ON. A preset signal can also equal the set value regardless of the current value for the function block and thereby setting the output ON.	22 Byte	6.12
Compare [CP]		The Compare Function Block monitors the current value of the input pin in relation to a preset expression. The expression consists of =,>,>=,<,<= or <>. If the compared value satisfies the expression subsequently the output pin is set on.	17 Byte	6.13
Analog Output		The Analog Output function takes a digital value input and delivers a corresponding analog voltage or current to a selected channel on the AL2-2DA module.	17 Byte	6.14
Offset Gain [OG]		The Offset Gain Function Block is based upon a linear function $Y=A/B*X+C$ to which the value obtained from an analog input (X:A01-A08) is set.	22Byte	6.15
Display [DP]		The Display Function Block is used as an interface between the user and the devices held within the controller. Current values, timer messages, user-defined messages can be read.	*4	6.16
Zone Compare [ZC]		The Zone Compare Function Block identifies whether the input value lies within a specified upper and lower limited zonal area and if so changes the status of the output accordingly.	20 Byte	6.17

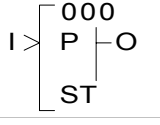
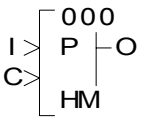
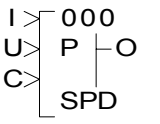
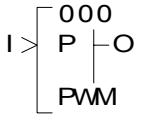
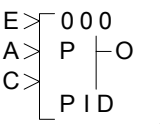
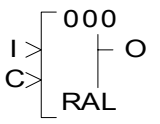
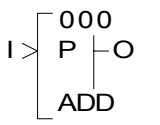
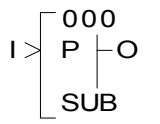
FB Name	FB Symbol	Description of Function Block	Memory Use	Section
Schmitt Trigger [ST]		The Schmitt Trigger Function Block compares an input value to preset high and low limits. The output is ON when the input value reaches the high limit and then falls below the lower limit. The function only processes the data when the function block is receiving an input signal.	19 Byte	6.18
Hour Meter [HM]		The Hour Meter Function Block holds the output status ON for a maximum of 32767 hours, 59 minutes and 59 seconds. If the input pin is turned OFF the elapsed time will hold its value until either the clear pin resets the time or the input pin is turned ON again.	19 Byte	6.19
Speed Detect [SPD]		The Speed Detect Function Block is used to count the incoming pulses max. 20Hz (with an extension module max. of 1kHz) for a set period of time. The upper and lower limits can be set from -32768 to +32767 and the Period interval's set range is 1 to 32767 in 10ms increments.	25 Byte	6.20
PWM [PWM]		The Pulse Width Modulation Function Block changes the output status according to a set period of time with a minimum of 100ms and a maximum of 3276700ms in increments of 100ms. The percentage duty for the function controls the amount of elapsed time before the output status is changed.	16 Byte	6.21
PID		The PID Function Block is the α2 implementation of PID, a control method used to obtain stable control over a system variable. It is equipped with an Auto-tuning function, which automatically adjusts the Function Block parameters for the specific application.	52 Byte	6.22
Retentive Alternate [RAL]		The Alternate Function Block is used to reverse the ON and OFF state of the output as and when the input pin receives a signal. The output will be set ON when the input pin goes high and remain ON until the input receives the second rising edge. When the power is turned OFF the function block will use the last alternation operation to control the output.	13 Byte	6.23
Addition [ADD]		The ADD Function Block is used to summate two input values	20 Byte	6.24
Subtraction [SUB]		The SUB Function Block is used to subtract two input values.	20 Byte	6.25

FB Name	FB Symbol	Description of Function Block	Memory Use	Section
Multiplication [MUL]		The MUL Function Block is used to multiply two input values.	20 Byte	6.26
Division [DIV]		The DIV Function Block is used to divide two input values.	20 Byte	6.27
Calculation [CAL]		The CAL Function Block is used to perform a calculation from the combination of different Arithmetic function blocks.	*3	6.28
Shift [SFT]		This Shift Function Block is used to transfer the Shift Input status just before the Input signal is set ON. It has a bit input pin, a shift input pin, a set input pin, a reset input pin and a bit output pin.	19 Byte	6.29
SMS [SMS]		The GSM SMS Function Block sends the LCD screen as a SMS message to either a mobile phone handset or an E-mail account for remote maintenance purposes.	*6	6.30
Short Message Receiving [SMR]		The Short Message Receive Function Block searches for the occurrence of a command in the SM. In case the command text is exactly included in the SM, outputs are changed.	*7	6.31
Short Message Receiving m [SMRm]		The Short Message Receive maintenance Function Block searches for the occurrence of a command in the SM. In case the command text is exactly included in the SM, outputs are changed. The function block can be setup from the TopMenu "Parameter" via the front panel keys.	*7	6.31
Call Detect [CD]		The Call Detect Function Block in case the numbers of digits of both phone numbers and the phone numbers itself are equal, the CD Function Block output is switched on.	30 Byte	6.32
Call Detect m [CDm]		The Call Detect Function Block in case the numbers of digits of both phone numbers and the phone numbers itself are equal, the CD Function Block output is switched on. The function block can be setup from the TopMenu "Parameter" via the front panel keys.	30 Byte	6.32

FB Name	FB Symbol	Description of Function Block	Memory Use	Section
Random One Shot [ROS]		The Random One Shot Function Block emits a random length single pulse to the output.	19 Byte	6.33
Delayed One Shot [DOS]		The Delayed One Shot Function Block emits a single pulse after a controlled delay to the output.	20 Byte	6.34
Delayed Alternate [DAL]		The Delayed Alternate Function Block alternates the status of the output with each pulse after a controlled delay.	16 Byte	6.35
Retentive Set/Reset [RSR]		The Set/Reset Function Block either holds an output ON (set) or releases the output OFF (reset.) Priority can be given to either input pin if both inputs have been energised. The default priority setting is dedicated to the reset input pin. When the power is turned OFF the function block will use the last set or reset operation to control the output.	14 Byte	6.36
Control Display [CDP]		The Control Display Function allows the user to control the LCD image screens. The function block can only be set in AL-PCS/WIN-E software for α2 Series Controllers. When control bit N04 is ON, it is possible to control the displayed User Screen.	*5	6.37
Connect [_B]		The Connect function block is an internal device used to show the memory used by input bits, system bits, AS-interface bits, and the operation keys. No function block appears on screen or is shown as being used in the "Memory Configuration Usage" dialog box. The purpose is only to calculate the memory that is used by the bits listed above.	10 Btyle	6.38
System Outputs		Control for external devices through relays and transistors.	10 Btyle	-

Note:

\*1 Number of bytes used =  $19 + 1 \times$  (Characters in equation)

\*2 Number of bytes used =  $8 + 4 \times$  (Number of time switches)

\*3 Number of bytes used =  $30 + 1 \times$  (Characters in equation)

\*4 Number of bytes used is decided by the displayed item.

Displayed Item		Number of bytes, α2 Series
Characters		$16 + 1 \times$ (Each character displayed)
Analog, FB value	Value	17
	Graph	23
Time, Date		14
Time Switch		17

\*5 Number of bytes used =  $32 + 3 \times$  (Number of screen)

\*6 Number of bytes used =  $12 + 1 \times$  (Characters in E-Mail address)

\*7 Number of bytes used =  $37 +$  (Number of characters of setup commands)



**Table 6.1.2: Handling of FB data in α2**

FB Name	EEPROM	RAM (hold for 20days)
Boolean	Setup	
Set/Reset	Setup	
Pulse	Setup	
Alternate	Setup	
Delay	Setup	
One Shot	Setup	
Flicker	Setup	
Time Switch	Setup	
Time Switch m	Setup	
Counter	Setup	Current counter value, Output status
U/D Counter	Setup	Current counter value, Output status
Compare	Setup	
Analog Output	Setup	
Offset Gain	Setup	
Display	Setup	
Zone Compare	Setup	
Schmitt Trigger	Setup	
Hour Meter	Setup Actual Time *1	Actual time
Speed Detect	Setup	
PWM	Setup	
PID	Setup	
Retentive Alternate	Setup	Output status
Addition	Setup	
Subtraction	Setup	
Multiplication	Setup	
Division	Setup	
Calculation	Setup	
Shift	Setup	Output status
SMS	Setup	
Short Message Receive	Setup	Word output value *2, Bit output status *2
Short Message Receive m	Setup	Word output value *2, Bit output status *2
Call Detect	Setup	Output status *2
Call Detect m	Setup	Output status *2
Random One Shot	Setup	
Delayed One Shot	Setup	
Delayed Alternate	Setup	
Retentive Set/Reset	Setup	Output status
Control Display	Setup	

\*1. From Version 3.00 or later:

The actual time of Hour Meter FB with FB number 197...200 is kept in EEPROM.

\*2. If configured in FB setup.

## 6.1 Definitions

DirectSet - Enter a value using the “+” and “-” keys.

Analog In - An analog input value from a System Input (A01, A02, A03,... A08).

FB Value - A value contained in a Function Block (T, t, N, n, Direct set, etc.)

Word Comparison - a 16 bit output value from a Function Block.

## 6.2 Abbreviations

**Table 6.2: Abbreviated terms used in describing function block**

Term	Description
I	Input pin for function block operation
1,2,3,4	Numbered Input pins for boolean logic type function blocks
O	Output pin for function block operation
S	Set pin for the function block
R	Reset pin for the function block
C	Clear pin for the function block
U	Increments a positive count to the Up/Down Counter Function Block
D	Increments a negative count to the Up/Down Counter Function Block
P	Preset signal input pin for the Up/Down Function Block
N	The count value set by the user, range: 0 - 32767
n	The actual count value. This value can be set to a one time offset value, range: 0 - 32767
T	<b>For Shift function block only.</b> Shift input pin
T	User specified Set Time Value, range: 0 - 3276.7sec
t	The elapsed time since the function set ON, range: 0 - 32767sec



Note: The following function block information, details specific explanation concerning front panel programming using the α2 Series Controller. However, it is assumed the user has read and understood Direct Programming Chapter 4. Thus, is capable of connecting function blocks together using the dedicated front panel keys. Hence, each function block provides step by step instructions for direct input having ignored the initial key presses detailed in Chapter 4.

### 6.3 Boolean block

The function block creates a logical operation using Boolean algebra consisting of AND, OR, XOR and NOT gates. It is possible to express the Logic functions in the form of an equation. Refer to Chapter 5 for detailed information concerning Boolean Logic operation.

**Table 6.3: Boolean Function Block**

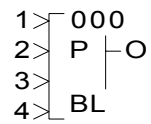
Function	Set Item	Description
	1,2,3,4	Numbered Input pins for boolean operation to control
	FB	User-defined logical boolean operation
	Output	The output is controlled directly from the result of the boolean operation involving the numbered input pins 1,2,3,4.

**Table 6.4: Boolean expressional data**

Item	Display	Description
AND	*	Intersection
OR	+	Disjunction
XOR	^	XOR
NOT	!	NOT
(	(	Left parenthesis
)	)	Right parenthesis
1	1	Signal connected to Input pin 1
2	2	Signal connected to Input pin 2
3	3	Signal connected to Input pin 3
4	4	Signal connected to Input pin 4
O	O	Output signal
=	=	Equal sign signal

#### 1) Boolean Operation

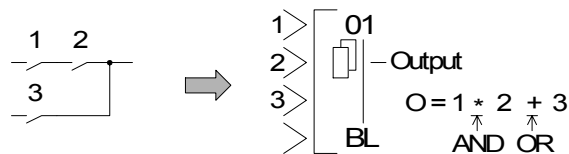

Setup of the Boolean Function Block directly from the α2 Series Controller

- 1 ) Allocate the input pin to be used for the function block.
- 2 ) Press the “OK” key with the cursor in the function block. The function block edit screen is displayed as shown.

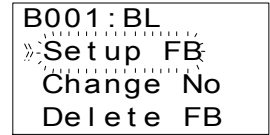

- 3 ) Select Setup FB using the “▲ and ▼” keys and press the “OK” key. The boolean function block edit screen is displayed as shown.

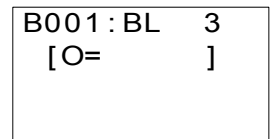

- 4 ) Enter the boolean expression via the “◀, ▶, ▲ and ▼ keys”. A boolean expression is displayed as shown.

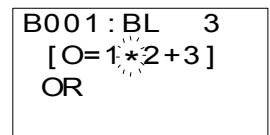

- 5 ) Press the “OK” key after entering the boolean expression.

## 6.4 Set/Reset Block

The function block will set or reset an output according to the input condition. When the SET input is energised, the Output is ON. When the RESET input is energised, the Output is OFF. When both inputs are energised simultaneously, the Output will follow the Priority Setting signal. A latched Output does not depend on the constant signal to retain its status.

**Set Priority** - When the Set input comes ON, the Output comes ON and remains ON until the Reset pin receives a signal. Once the Output is ON, the Set input signal can turn OFF without effecting the Output. If both the Set and Reset pins are ON, the Output is ON.

**Reset Priority** - The operation is the same as the Set Priority except that when both pins are ON, the Output is OFF.

**Table 6.5: Set/Rest Function Block**

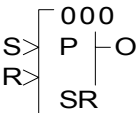
Function	Set Item	Description
	S	Set pin for the function block
	R	Reset pin for the function block
	FB	Allocates priority to either the set or reset function when both pins are ON
	Output	The output of the function block operates in either an ON or OFF state. 1) Set the output ON until the reset pin is ON. 2) Decides the status of the output depending which input pin has priority.

### 1) Operation of reset priority

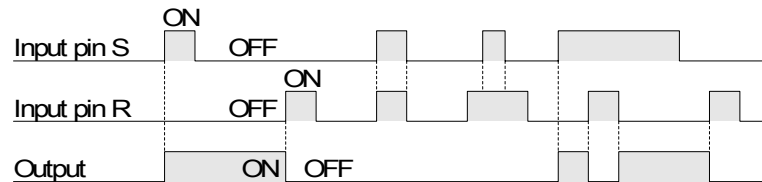

### 2) Operation of set priority

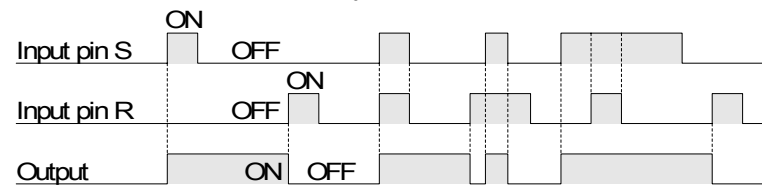

Setup of the Set/Reset Function Block directly from the α2 Series Controller

- 1 ) Allocate the set and reset pins for the function block.
- 2 ) Press the “OK” key with the cursor in the function block. The function block edit screen is displayed as shown.

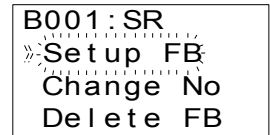

- 3 ) Select Setup FB using the “▲ and ▼” keys and press the “OK” key. The Set/Reset priority screen is displayed as shown.

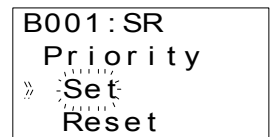

- 4 ) Select the Set or Reset priority using the “▲ and ▼” keys and press the “OK” key to return to the function block edit screen.

## 6.5 Pulse Block

The function block emits a single pulse at any of the following user defined times:

**Table 6.6: Pulse Function Block**

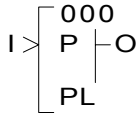
Function	Set Item	Description
	I	Input pin for pulse operation
	FB	Sends a single pulse depending on the function block conditional setup. 1) Rise Edge (From Off to On) 2) Fall Edge (From On to Off) 3) Both Edge (From Off to On and On to Off)
	Output	The function block sends a single pulse depending on the chosen pulse operation 1) Rise Edge (From Off to On) 2) Fall Edge (From On to Off) 3) Both Edge (From Off to On and On to Off)

### 1) Rise Edge (From Off to On) Operation

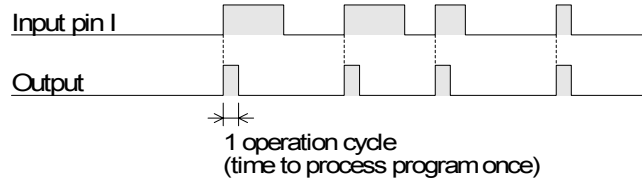

### 2) Fall Edge (From On to Off) Operation

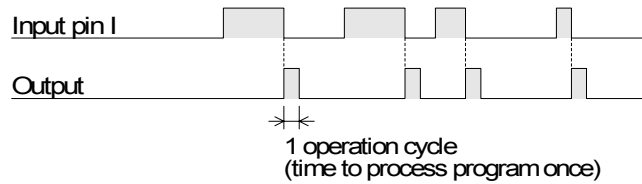

### 3) Both Edge (From Off to On and On to Off) Operation

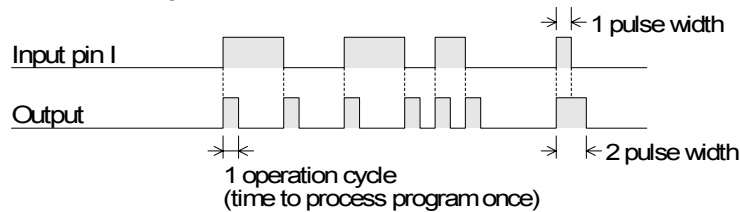

Setup of the Pulse Function Block directly from the α2 Series Controller

- 1 ) Allocate the input pin to be used for the function block.
- 2 ) Press the “OK” key with the cursor in the function block. The function block edit screen is displayed as shown.

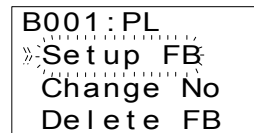

- 3 ) Select Setup FB using the “▲ and ▼” keys and press the “OK” key. Select using the “▲ and ▼” keys the initiation type for the pulse operation.

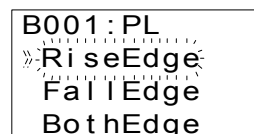

- 4 ) Press the “OK” key to return to the function block edit screen.



### 6.6 Alternate Block

The function block inflicts a reversal of the ON and OFF state of the output as and when the input is given to the input pin.

**Table 6.7: Alternate Function Block**

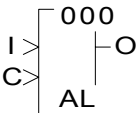
Function	Set Item	Description
	I	Input pin for alternation operation
	C	Clear input pin resets the state of the output regardless of the input given.
	FB	N/A
	Output	The output is affected in the following operation: 1) Reverse the ON/OFF state of the output whenever the input signal's ON/OFF operation to the input pin is turned ON (ON to OFF or OFF to ON) 2) The clear selection resets the output regardless of the input given.

1) Alternate Operation

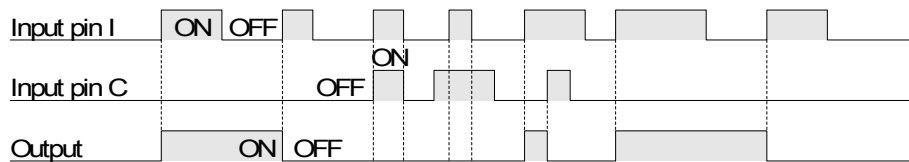

## 6.7 Delay Block

The function block delays the signal to an output for a set length of time. The On or Off delays can be set individually or in combination. Example: The On Delay Time is set to 5 seconds. The Delay Block Input signal comes ON; five seconds later the Delay Block Output will come ON. The Output signal stays ON as long as the Input signal is ON. The Output signal turns OFF at the same time the Input signal turns OFF. The Clear Input will turn the Output OFF and cancel the current operation. The Clear pin over-rides the Input pin if both signals are ON simultaneously.

The On Delay option will delay the Output from turning ON for a set time after the Input comes ON. The Off Delay will delay the Output from turning OFF for a set time after the Input has turned OFF.

**Table 6.8: Delay Timer Function Block**

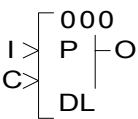
Function	Set Item	Description
	I	Input pin for delay timer operation
	C	Clear input pin resets the state of the output regardless of the input given.
	FB	Time units: 10ms, 100ms or 1s (*Note)
	Output	The following items are applicable for the delay function block: 1) The lag time setting for energising the output from a given input signal can be given a controlled delay time; The starting value has a range from 0s to 32767s 2) The lag time setting for deenergising the output from a given input signal can be given a controlled delay time; The starting value has a range from 0s to 32767s 3) If the clear signal of the input pin C is turned on while the delay function block is in operation consequentially the current value of the ON delay timer and OFF delay timer resets to "0." Thus, the output is turned OFF. 4) The following items are available for other function blocks: a) On Delay b) Current On Delay c) Off Delay d) Current Off Delay



Note: The ON/OFF delay time cannot be less than one scan time for the controller; otherwise, the Delay Function Block will not perform its assigned task for the time specified. Users can monitor the scan time from the α2 Series Controller. Scan time is dependent on the user-program; therefore, caution is needed as and when time units are selected.

### 1) Delayed Operation

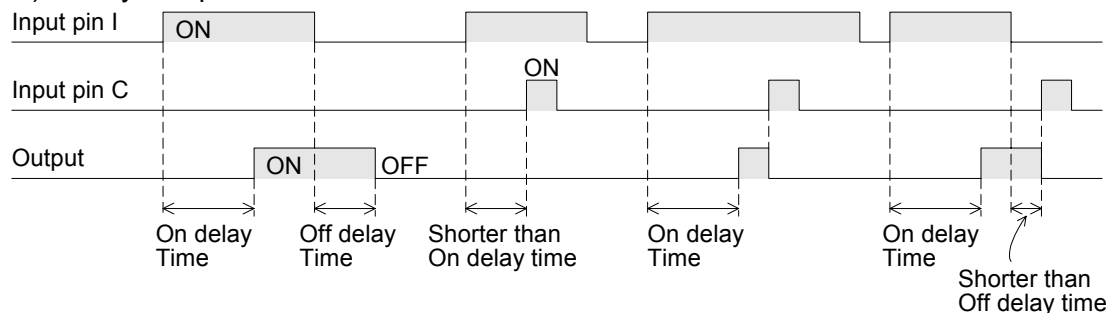

2 ) ON delay timer

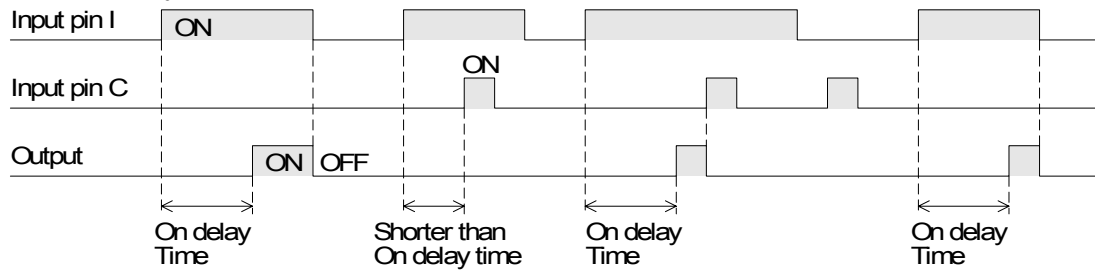

3 ) OFF delay timer

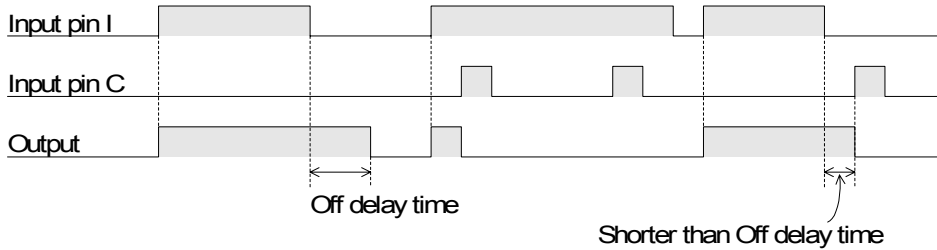

Setup of the Delay Function Block directly from the α2 Series Controller

- 1 ) Allocate the input pin to be used for the function block.
- 2 ) Press the “OK” key with the cursor in the function block. The function block edit screen is displayed as shown.

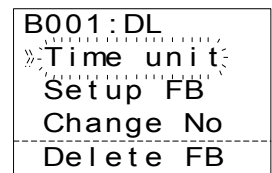

- 3 ) Press the “OK” key to set the Time unit for the delayed output.

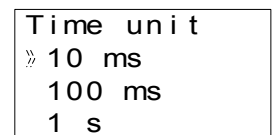

- 4 ) Press the “OK” key having selected the value for the delayed time unit and return to the function block edit screen. Using the “▲” and “▼” keys highlight the Setup FB and press the “OK” key. The screen displayed is shown.

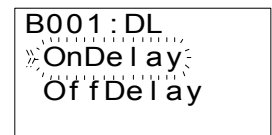

- 5 ) Select the On or Off Delay using the “▲” and “▼” Keys and press the “OK” key. The Delay time can be entered using the “+” or “-” keys.

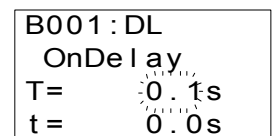

- 6 ) Press the “OK” key to accept the time figures and subsequently press the “ESC” key to return to the function block edit screen.

## 6.8 One Shot Block

The function block gives a single Output pulse for a controlled duration of time. If the Set Time is 0 seconds, the block will function like the Pulse block. The Reset Input returns the Output to the OFF condition and will override the Input pin.

Table 6.9: One Shot Function Block

Function	Set Item	Description
	I	Input pin for one shot operation
	C	Clear input pin resets the state of the output regardless of the input
	FB	Time units: 10ms, 100ms or 1s (*Note) The One Shot time T and t can be set using the chosen time units. A Time or Input priority can be set.
	Output	The following items are applicable for the one shot function block: 1) A period of 0s to 32767s for a single pulse output can be set. 2) The output is turned ON during the single shot time duration as and when the input pin receives a signal. 3) The output is cleared as and when the clear pin receives a signal. 4) The following items are available for other function blocks: a) One Shot b) Current One Shot



Note: The set time cannot be less than one scan time for the controller; otherwise, the One Shot Function Block will not perform its assigned task for the time specified. Users can monitor the scan time from the α2 Series Controller. Scan time is dependent on the user-program; therefore, caution is needed as and when time units are selected.

### One Shot Operation

#### 1) Time Priority

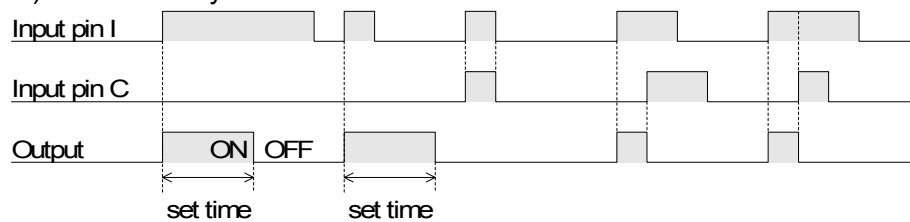

#### 2) Input priority

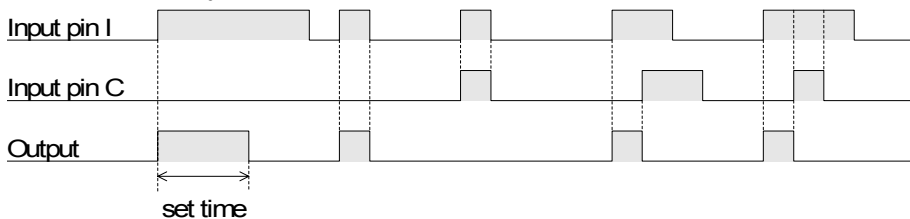

Setup of the One Shot Function Block directly from the α2 Series Controller

- 1 ) Allocate the input pin to be used for the function block.
- 2 ) Press the “OK” key with the cursor in the function block. The function block edit screen is displayed as shown.

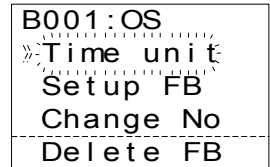

- 3 ) Press the “OK” key to set the Time unit for the delayed output.

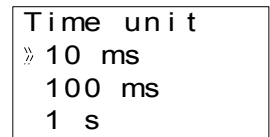

- 4 ) Press the “OK” key having selected the value for the one shot time unit and return to the function block edit screen. Using the “▲” and “▼” keys highlight the Setup FB and press the “OK” key. The screen displayed is shown.



- 5 ) Select the One Shot or Priority option using the “▲” and “▼” Keys and press the “OK” key. The One Shot time can be entered using the “+” or “-” keys.

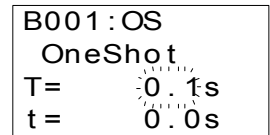

- 6 ) The Priority can be entered using the “▲” or “▼” keys.

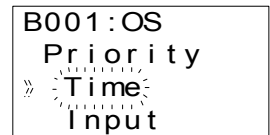

- 7 ) Press the “OK” key to accept the time figures and subsequently press the “ESC” key to return to the function block edit screen.

## 6.9 Flicker Block

The function block provides a method to give a patterned ON/OFF Output signal. The user can set independent ON and OFF times for the Output. The output pattern can be dependent on an input signal, or can be performed for a preset cycle time or number of repetitions.

**Table 6.10: Flicker Function Block**

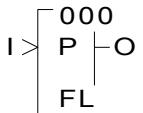
Function	Set Item	Description
	I	Input pin for flicker operation
	FB	The following three set items exist: 1) The applicable range for the turning the output ON is 0s to 32767s Time intervals are 10ms, 100ms or 1s (*Note) 2) The applicable range for the turning the output OFF is 0s to 32767s Time intervals are 10ms, 100ms or 1s (*Note) 3) Blinking operation a) Cycles count (frequency assigned operation) maximum number of cycles to be set is 32767 b) Time count maximum 32767 c) Continuous control
	Output	The control operations provides an ON/OFF state for the output. 1) The output state directly reflects the ON and OFF condition of the input signal at the input pin. 2) The following items are available for other function blocks: a) On Flicker b) Current On Flicker c) Off Flicker d) Current Off Flicker e) Cycle or Time f) Current Cycle or Time



Note: The set time cannot be less than one scan time for the controller; otherwise, the Flicker Function Block will not perform its assigned task for the time specified. Users can monitor the scan time from the α2 Series Controller. Scan time is dependent on the user-program; therefore, caution is needed as and when time units are selected.

### Flicker Operation

#### 1) Continuous control action

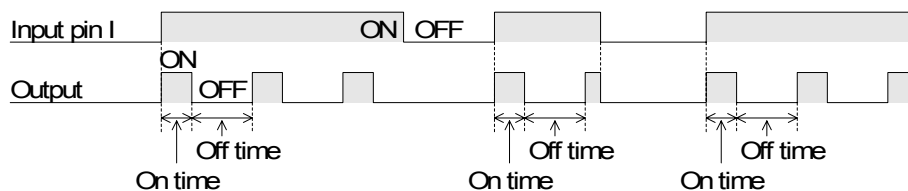

#### 2) Frequency control action

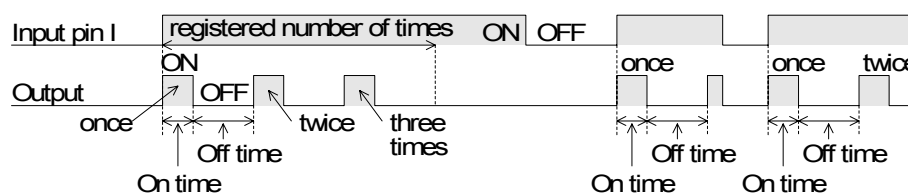

3 ) Time control action

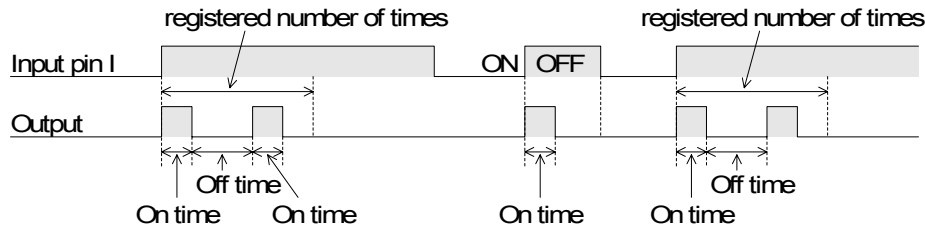

Setup of the Flicker Function Block directly from the α2 Series Controller

- 1 ) Allocate the input pin to be used for the function block.
- 2 ) Press the “OK” key with the cursor in the function block. The function block edit screen is displayed as shown.

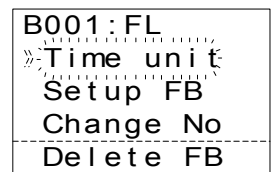

- 3 ) Press the “OK” key to set the Time unit for the delayed output.

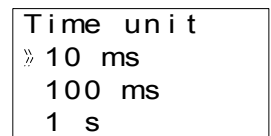

- 4 ) Press the “OK” key having selected the value for the flicker time unit and return to the function block edit screen. Using the “▲” and “▼” keys highlight the Setup FB and press the “OK” key. The screen displayed is shown.

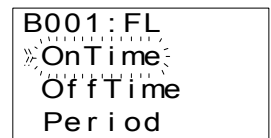

- 5 ) Select the On Time, Off Time or Period option using the “▲” and “▼” Keys and press the “OK” key. The On Time can be entered using the “+” or “-” keys.

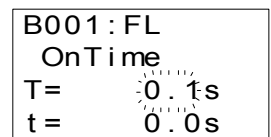

- 6 ) The OffTime can be entered using the “+” or “-” keys.

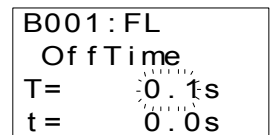

- 7 ) The Period can be entered using the “▲” and “▼” Keys.

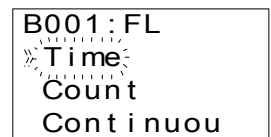

- 8 ) Using the “▲” and “▼” keys highlight the Time option and press the “OK” key. The Time can be entered using the “+” or “-” keys.

```
B001 : FL
Time
T= 0.0s
t= 0.0s
```

- 9 ) The Count can be entered using the “+” or “-” keys.

```
B001 : FL
Count
N= 0
n= 0
```

- 10 ) Press the “OK” key to accept the time values and subsequently press the “ESC” key to return to the function block edit screen.



## 6.10 TimeSW Block

The real time clock within the TimeSW block can be programmed for date or weekly schedule operation. Up to 50 time settings can be programmed into each Function Block and up to 200 function blocks can be used in any program. The total memory for a α2 program is 5000 bytes; the number of time switches available will be limited by the program memory. Switch setting numbers must be created with the NewData option. To input or update the data, scroll to the desired time switch, press the “OK” key, and use the EditData function.

The difference between TS and TSm is allowable maintenance (m) from the TopMenu “Parameter” in the α2 controller for direct programming.

**Table 6.11: Time Switch Function Block**

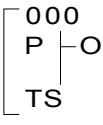
Function	Set Item	Description
	FB	A function block can register 50 set schedules or less. The function capacity for a controller is 200 blocks. The real-time clock functionality is restricted by the 5000 byte memory capacity for the controller.
	Output	1) The ON and OFF status of the output is controlled by the scheduled calendar. 2) The date assignment is given priority if both date and week assignments occur on the same scheduled day. 3) The largest schedule number is given priority when more than one time switch function block occurs on the same day.

### 6.10.1 Setting the First Time Switch

Enter the Function Block Setup Screen and the message “No Setting Data” will appear. Press the “OK” key to enter the NewData Screen. The New Data screen lets you choose between using a calendar type of setting (Date) or a repetitive type of setting (Weekly). Each TimeSW Block can mix Date and Weekly time switches indiscriminately.

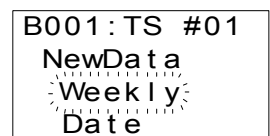

After choosing the type of time switch, a screen will appear with a time switch number flashing in the top right corner. This screen is used to select the time switch to edit by using the “+” or “-” keys. The only time switch available to begin is TS #01. Press the “OK” key to display the option screen shown at right.

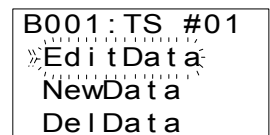

**EditData** - Edit the data for the time switch number shown in the top line.

**NewData** - Add a new time switch. Time switch numbers will increment from the highest current number.

**DelData** - Deletes a time switch. Higher numbered time switches will decrement.

Choose EditData and enter data as described in the following sections:

### 6.10.2 For the Date operation:



The Date calendar screen is shown at the right. The setting options include the year/month/day, hour (0-23), minute, and the Output ON or OFF action.

```

B001: TS #02
      Thu
01/01/1998
00:00→off

```

The example shows a time switch that will turn ON on August 3rd, 2002 at 9:00 AM (Note - 9:00 PM is designated on the 24 hour clock as 21:00). The day of the week is automatically updated when the date is changed.

```

B001: TS #02
      Fri
03/08/2002
09:00→on

```

A Monthly mode is also available to the user for direct per month setting. The user can set an ON or OFF condition for a specified date of the month. The time switch can also be programmed to perform on a yearly basis. Reduce the year to below 1998; the numbers signifying the year will display as "\*" and the day of the week message will appear as "Yearly". The operation will perform each year on the specified date.

### 6.10.3 For the Weekly Operation:



The Weekly Calendar is shown at right. The setting options include week of the month (0-5), day of the week, hour (0-23), minute and Output ON/OFF status. Use the left, right, up, and down buttons to move to different locations on the LCD display.

```

B001: TS #01
-----
-----
00:00→off

```

The example screen shown at the right shows that the Output will turn ON at the following times:

```

B001: TS #01
1-34-
-M-W-S
11:20→on

```

The first week of the month on Monday, Wednesday, and Saturday at 11:20 AM.  
The third week of the month on Monday, Wednesday, and Saturday at 11:20 AM.  
The fourth week of the month on Monday, Wednesday, and Saturday at 11:20 AM.

### 6.10.4 To Enter New Time Switches

Enter the Function Block Setup Menu. Enter OK until the screen at right appears. Scroll down and enter NewData. Choose either the Weekly or the Date type of switch. The TimeSwitch has been created. Please see section 6.8.5 for instructions on how to enter the data.

```

B001: TS #01
»EditData
NewData
DeIData

```

### 6.10.5 To Edit Time Switches

Enter the Function Block Setup Menu. The currently selected time switch number will be flashing in the top right hand corner. Use the “+” or “-” key to go to the time switch desired to edit and press the “OK” key. Alternately, when the Edit Data screen appears, use the “+” or “-” keys to change the time switch number.

```
B001 : TS #02
          Thu
01 / 01 / 1998
00 : 00 → o f f
```

Choose the EditData option to view the selected time switch data.  
Update data as required and accept with the “OK” key.

### 6.10.6 To Delete Time Switch Data

Enter the Function Block Setup Menu. The currently selected time switch number will be flashing in the top right hand corner. Use the “+” or “-” key to go to the time switch to be deleted and press the “OK” key. Choose DelData at the bottom of the screen and accept with “OK”.

```
B001 : TS #03
EditData
NewData
De l D a t a
```

### 6.11 Counter Block

The function block counts input pulses and turns the Output ON when a preset limit is reached. The counter counts up only to a maximum value of 32767 and increments on the rising pulse. Normal inputs count to a maximum of 20Hz, however, with an extension module attached inputs EI1 or EI2 can count to a maximum of 1KHz.

**Table 6.12: Counter Function Block**

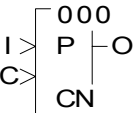
Function	Set Item	Description
	I	Input pin for one shot operation
	C	Clear input pin resets the state of the output regardless of the input given if reset has been given priority.
	FB	The counter function block can be incremented to a maximum of 32767 counts.
	Output	1) When the current incremental value reaches the set value of the counter function block the status of the output is ON. 2) The clear signal will reset the value of the counter to 0 3) One incremental count is only registered if the input pin locates a rising edge. 4) The following items are available for other function blocks: a) Count b) Current Count

**Counter Operation**

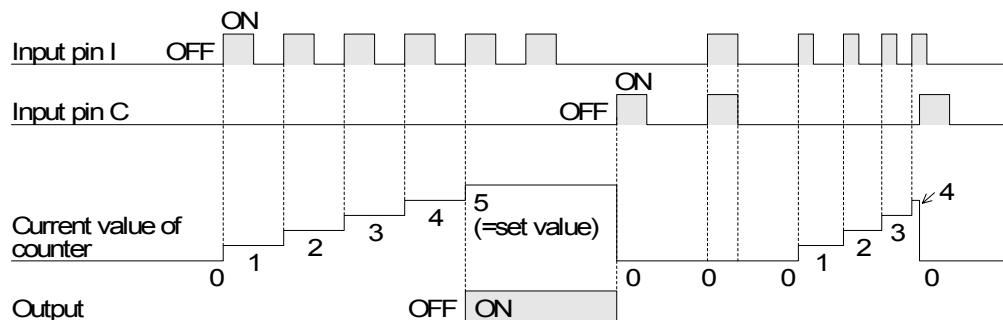

**Setup of the Counter Function Block directly from the α2 Series Controller**

- 1) Allocate the input pin to be used for the function block.
- 2) Press the “OK” key with the cursor in the function block. The function block edit screen is displayed as shown

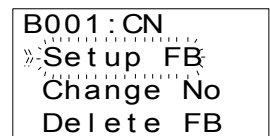

- 3) Press the “OK” Key and enter the counter function block settings using the “+, -, ▲ and ▼” keys.

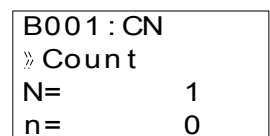

- 4) Press the “OK” Key and return to the function block edit screen.

### 6.12 Up/Down Counter Block

The function block counts upwards and downwards and will turn the Output ON at the Preset (or greater) value. The values are updated on the rising edge. Input pulses are counted to a maximum of 20Hz.

Table 6.13: The Counter Function Block

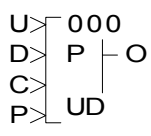
Function	Set Item	Description
	U	Increments a positive count to the up/down counter function block
	D	Increments a negative count to the up/down counter function block
	C	Clear pin for the function block
	P	Preset signal input pin for the up/down function block
	FB	The set value of the function block can be selected from the following three sources: 1) DirectSet (Constant value): setting range -32768 to +32767 with an initial value 0 2) Analog In (Analog Input) : setting range A01 to A08 with an initial input A01 3) FB Value: output value from a function block
Output	1) Increments a positive count if a signal is received from pin U. 2) Increments a negative count if a signal is received from pin D. 3) If pin U and pin D receive a signal simultaneously the current count will not change. 4) The ON status of the output is set from the current value equaling or exceeding the set value. 5) The current value becomes the set value if the preset pin P is ON; the status of the output becomes ON. 6) The following item is available for other function blocks: a) Current value b) Setting value	

1) Counter Operation of input pin U, input pin D, current value and output

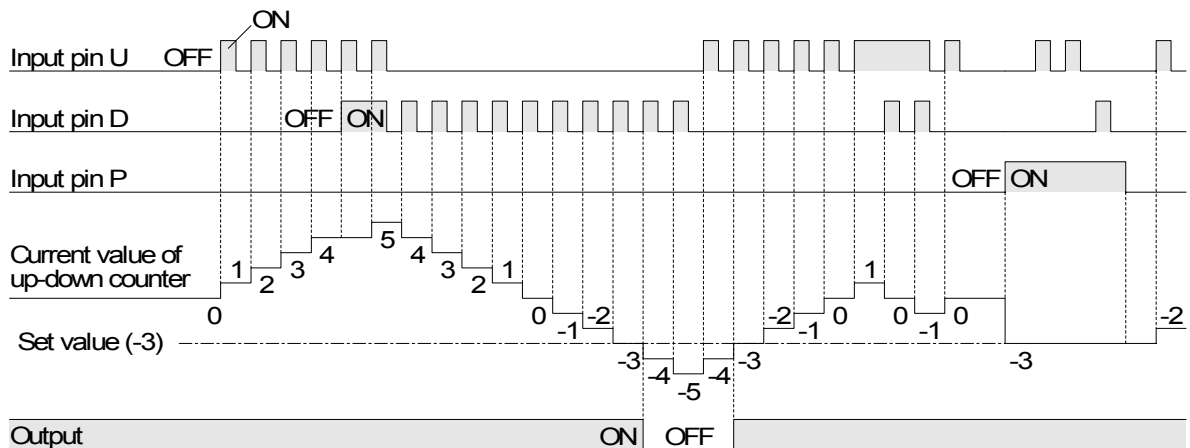

2 ) Counter Operation of input pin U, input pin D, input C, input pin P, current value and output

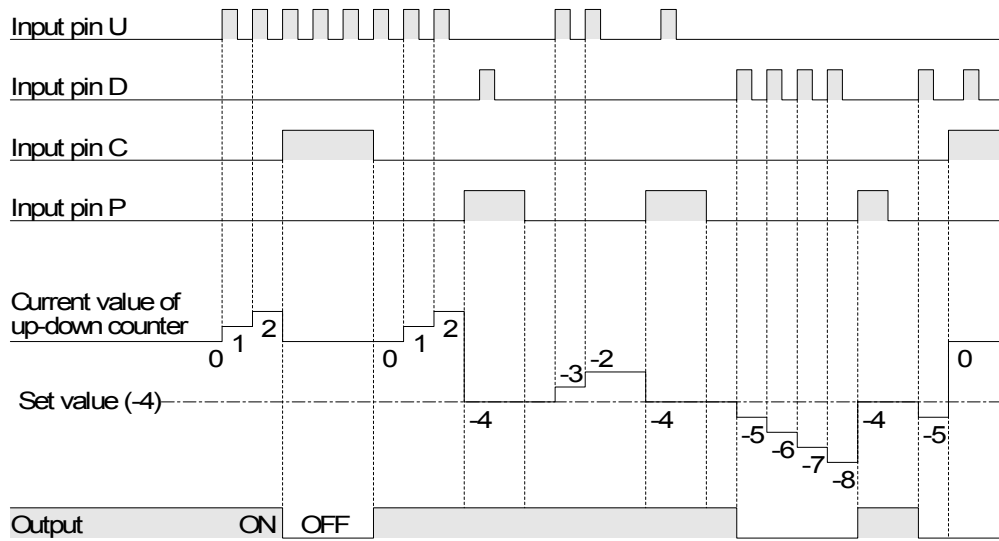

Setup of the Up/Down Counter Function Block directly from the α2 Series Controller

- 1 ) Allocate the input pin to be used for the function block.
- 2 ) Press the “OK” key with the cursor in the function block. The function block edit screen is displayed as shown.

```
B001:UD
»:Setup FB
Change No
Delete FB
```

- 3 ) Press the “OK” Key and enter the Up/Down counter function block settings using the “+, -, ▲ and ▼” keys. The DirectSet of the count settings can be entered.

```
B001:UD
»:DirectSet
N= 0
n= 0
```

- 4 ) Press the “OK” Key and an Analog In function block value can be entered.

```
B001:UD
»:DirectSet
Analog In
FB Value
```

- 5 ) Press the “OK” key and using the “ESC” key return to the function block edit screen.

### 6.13 Compare Block

The function block compares value 1 (V1) with value 2 (V2) using an operational based instruction based upon the following conditions: =, >, >=, <, <= or <>. If current values satisfy the operational expression then the output status is ON.

**Table 6.14: Compare Function Block**

Function	Set Item	Description
	I	Input pin for compare operation
	FB	The following three set items exist: 1) Compare Value 1 (V1): a) DirectSet (Constant value): setting range -32768 to +32767 with an initial value 0 b) Analog In (Analog Input) : setting range A01 to A08 with an initial input A01 c) FB Value: output value from a function block 2) Operational Expression: =, >, >=, <, <=, <> 3) Compare Value 2 (V2): a) DirectSet (Constant value): setting range -32768 to +32767 with an initial value 0 b) Analog In (Analog Input) : setting range A01 to A08 with an initial input A01 c) FB Value: output value from a function block
	Output	If Compare value 1 (V1) and Compare value 2 (V2) satisfies the operational expression the status of the output is ON.

Setup of the Compare Function Block directly from the α2 Series Controller

- 1) Allocate the input pin to be used for the function block.
- 2) Press the “OK” key with the cursor in the function block. The function block edit screen is displayed as shown.

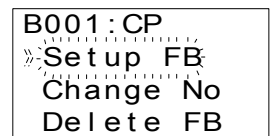

- 3) Press the “OK” Key and enter the function block settings using the “◀ and ▶” keys.

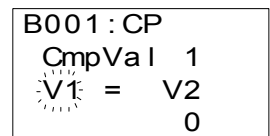

- 4) Pressing the “OK” key invokes the menu that lists the function block input data type.

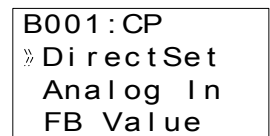

5 ) Press the “OK” Key and a Direct Set value can be entered..

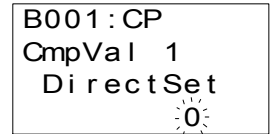

6 ) Or press the “ESC” key to return to the function block data input type menu, select the Analog In selection and press the “OK” key

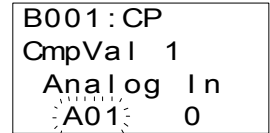

7 ) Or press the “ESC” key to return to the function block data input type menu, select the FB Value selection and press the “OK” key.

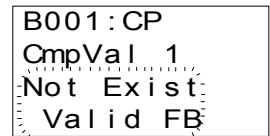

8 ) Using either the “OK” key or the “ESC” key depending on the acceptance of the setting. Press the “OK” key when the Condition is highlighted. Thus, selecting the correct comparator from the range.

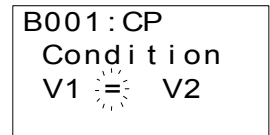

9 ) Having set the V1, condition and V2 simultaneously use the “ESC” key to return to the function block edit screen.



### 6.14 Analog Output

The digital value on the word input pin is converted to a corresponding output voltage or current on the specified channel on the AL2-2DA module. One of two output modes can be selected, voltage or current output. In voltage output mode, digital values from 0 to 4000 are mapped onto analog values from 0 to 10 volts. In the current output mode, digital values from 0 to 2000 are converted to a range of 4 to 20 mA. If a digital value less than the lower limit of 0 is input on the word input pin, the analog output will default to the lower limit of the analog range (0 V or 4mA) for the specified output mode. If a digital value greater than the upper limit is input, the analog output will default to the upper limit of the analog range (10V or 20mA) for the specified output mode. The acceptable data types for the word input pin are constants, analog inputs or FB output values. When more than one Analog Output FB is configured to use the same channel, all FBs will be executed if their enable pins are active. The FB that is executed last in the program will control the operation of the AL2-2DA board. The user cannot know which FB will be executed last due to lack of knowledge of the controller’s processing algorithms. Care should be taken to avoid situations in which two or more analog output function blocks may conflict.

**Table 6.15: Analog Output Function Block**

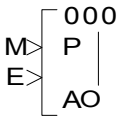
Function	Set Item	Description
	I	The digital value to be converted is entered on this word input pin.
	M	Output Mode. If OFF voltage mode is selected, if ON current mode is selected. If not connected voltage mode is selected (default).
	E	D/A conversion is only effective when Enable is ON. An unconnected enable input defaults to ON.
	FB	The following two set item exist: 1) Digital word input to be converted by D/A conversion. Source can be a constant, an analog input or the WORD output of a FB. 2) Select which channel (channel 1 or 2) to use on the 2DA board.
	Output	1) Bit Output pin. When converting digital to analog, this pin is ON.

#### Output Characteristics

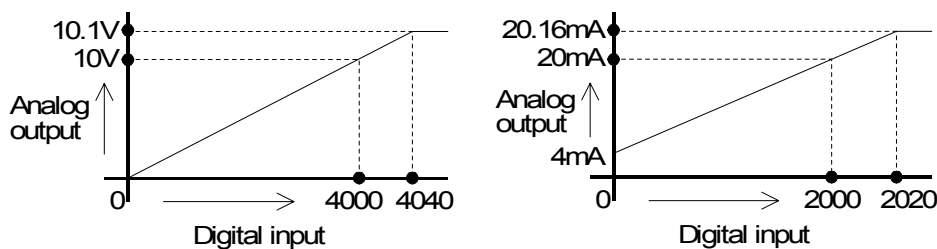

Set up of the Analog Output Function Block directly from the α2 Series Controller

- 1) Allocate the input pin to be used for the function block.

2 ) Press the “OK” key with the cursor in the function block. The function block edit screen is displayed as shown

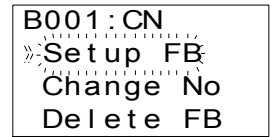

3 ) Highlight “Setup FB” and press “OK”.



4 ) Highlight “InputVal” and press “OK”.

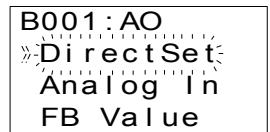

5 ) If a constant output voltage is required, highlight “DirectSet” and press “OK.” If not, skip to step 7.

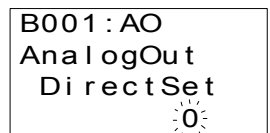

6 ) Enter a Direct Set value using the “+ and -” keys and press the “OK” key to accept the value. Skip to Step 11.



7 ) If an analog input will be used, highlight “AnalogIn” and press “OK.” If not, skip to step 9.

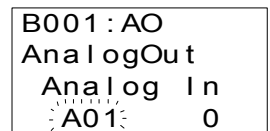

8 ) Select the appropriate analog input and press “OK. Skip to Step 11.”

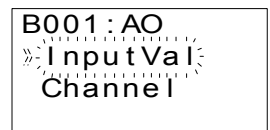

9 ) If an FB word output will be used as the input value for the Analog Output FB, highlight “FB Value” and press “OK.” If not, skip to step 11.

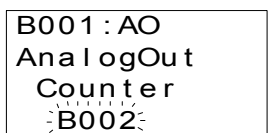

10 )Select the appropriate FB output and press “OK using the “+” and “-” keys. After selecting the appropriate function block, select the FB value to be used. The controller will return to the “Setup FB” menu.”



11 ) Under the “Setup FB” menu, highlight “Channel” and press “OK.”

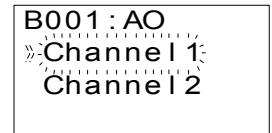

12 )Select “Channel 1” or “Channel 2” and press “OK”

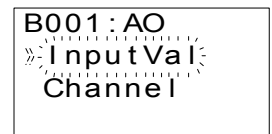

13 )After setting up the function block, use the “ESC” key to return to the function block edit screen.

### 6.15 OFFSET Block

The function block is used to adjust an Analog Input value according to the following linear expression:  $Y=A/B*X+C$  from which the values obtained through the analog input channels X:A01-A08 are set.

**Table 6.16: Offset Gain Function Block**

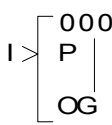
Function	Set Item	Description
	I	Input pin for Offset Gain operation
	FB	1) Setting the operational expression for the linear $Y=A/B*X+C$ function a) Y = Output value b) A = Gain numerator value set range: -32768 to +32767 c) B = Gain denominator value set range:-32768 to +32767 d) X = Analog input value from source A01 to A08 e) C = Offset value set range:-32768 to +32767  2) Setting the upper and lower clamp values (limit values) a) H = Upper Limit set range:-32768 to +32767 b) L = Lower Limit set range:-32768 to +32767
	Output	The function block only calculates data.  1) Data output: a) The resultant of the linear operation is rounded up or down when the values are within the clamp (limit) values. b) No signal from the input equates to the function block holding the previous value obtained from the linear operation.  2) The following items are available for other function blocks: a) Gain Analog value

Operation of Offset Gain relationship

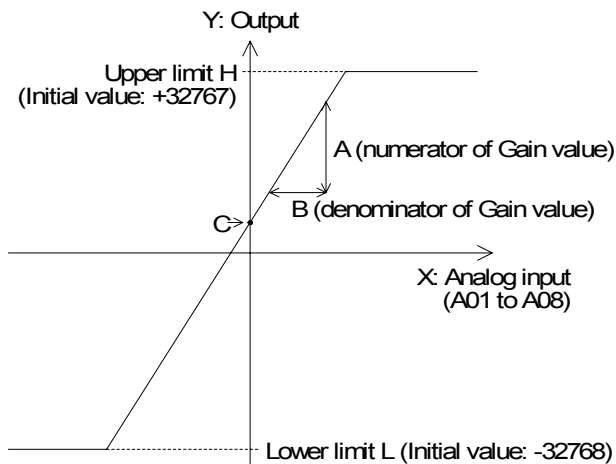

Setup of the Offset Gain Function Block directly from the α2 Series Controller

- 1 ) Allocate the input pin to be used for the function block.
- 2 ) Press the “OK” key with the cursor in the function block. The function block edit screen is displayed as shown.

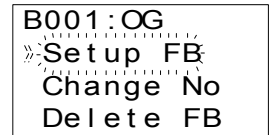

- 3 ) Press the “OK” Key and enter the function block settings using the “▲ and ▼” keys. The parameters A, B, X, C, Low limit and High limit have to be specified for the linear expression to operate correctly..

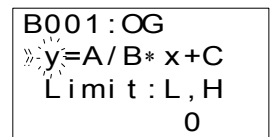

- 4 ) Using the “◀ and ▶” arrows highlight A and press the “OK” key. A Direct Set using the “+ and -” keys can be entered, subsequently press the “OK” key to accept the Direct Set value. (Repeat operation for B)

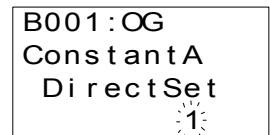

- 5 ) Highlight X using the “◀ and ▶” keys and press the “OK” key to set the Analog In channel.

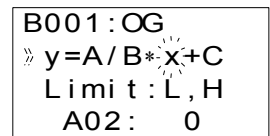

- 6 ) The Analog In channel can be selected using the “+ and -” keys, subsequently press the “OK” key to accept the channel.

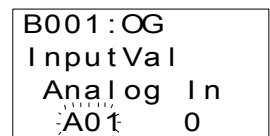

- 7 ) Highlight C using the “◀ and ▶” keys and press the “OK” key to set the constant value.

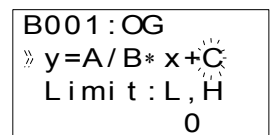

- 8 ) A Direct Set using the “+ and -” keys can be entered, subsequently press the “OK” key to accept the Direct Set value.

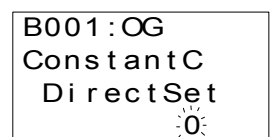

9 ) Using the “▲ and ▼” arrows highlight the high and low limit values.

```

B001:OG
y=A/B*x+C
» Limit:L,H
-32768
    
```

10 ) Press the “OK” and a Directset of the Low limit can be entered using the “+ and -” keys.

```

B001:OG
LimitLow
DirectSet
-32767
    
```

11 ) Press the “OK” key to accept the value and use the “◀ and ▶” arrows to highlight the high limit value. Press the “OK” key and a directset value can be entered using the “+ and -” keys.

```

B001:OG
LimitHigh
DirectSet
32767
    
```

12 ) Press the “ESC” key until the FBd is displayed.

## 6.16 Display Block

The function block displays the specified information from the connected function block. Allows information to be displayed on the LCD screen. The Position line sets the starting point for the data or message to be displayed. There are 12 columns and 4 rows that can be utilised.

**Table 6.17: Display Function Block**

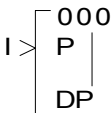
Function	Set Item	Description
	I	Input pin for Display operation
	FB	<p>1) The data is positioned using an X,Y plot</p> <ul style="list-style-type: none"> <li>a) X axis : setting range:1-12</li> <li>b) Y axis : setting range:1-4</li> <li>c) Length : setting range:1-12</li> </ul> <p>The following Data items can be viewed using the display function block:</p> <ul style="list-style-type: none"> <li>1) Strings - number of characters in a string must not exceed 63                             <ul style="list-style-type: none"> <li>a) Fixed</li> <li>b) Flicker : setting range: 1-255 *100ms Period</li> <li>c) Scroll : setting range: 0-255 *100ms Interval</li> </ul> </li> <li>2) Analog In                             <ul style="list-style-type: none"> <li>a) Value</li> <li>b) Graph : Minimum : -32768 to 32767 Maximum : -32768 to 32767 Length : 1 to 12</li> </ul> </li> <li>3) Function Block Value</li> <li>4) Time Switch Data</li> <li>5) Date : mm/dd/yyyy</li> <li>6) Time : hh:mm</li> </ul>

### 6.16.1 Displaying Data Onscreen

Character strings (letters, numbers, symbols), Analog values, Function Block values, the current time and date can be viewed on the screen. If two Display blocks contain the same positioning data, the data from the Function Block with the highest number will be displayed.

Character strings that run over the available number of spaces on a line will show on the next line down. Function Block values, analog values, date, and time will not be displayed on the next line. Function Block and analog values will be automatically updated on the screen as they change.

When entering character strings, choose the desired character with the “▲ or ▼” keys. Move to the left or right with the arrow keys. Accept the data with the “OK” key after all the data has been entered.

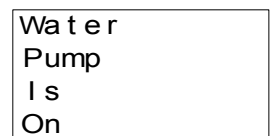

The display shows On-screen only when the input is activated.

### 6.16.2 Editing Data Onscreen

Values in Function Blocks, time, and date can be changed using the front panel keys. During the function block setup, when the type of data to be shown onscreen is chosen - i.e. Function Block, Date, or Time - type the “+” key to place the Display Block in the front panel edit mode. An “e” will appear when the “+” is depressed. When the program is in Run, depressing any key (that is not used elsewhere in the program) will cause one set of data onscreen to flash. If multiple entries can be edited, use the arrow keys to choose the data to change.

To edit the time or date, press “OK” key when the appropriate data is flashing. Edit as required and accept with the “OK” key. To edit the function block values, proceed to the value to be adjusted as described above. Use the “+” and “-” keys to adjust the value onscreen and in memory. To exit to the Top Menu, press the “ESC” and “OK” keys simultaneously. The Display edit mode can be removed from the program by entering the “-” key in the function block setup when the “e” is flashing. The “e” will disappear when the “-” key is pressed.

Setup of the Display Function Block directly from the α2 Series Controller

- 1 ) Allocate the input or word pin to be used for the function block.
- 2 ) Press the “OK” key with the cursor in the function block. The function block edit screen is displayed as shown.

```

B001:DP
» Setup FB
Change No
Delete FB

```

- 3 ) Press the “OK” Key and enter the function block settings using the “▲ and ▼” keys. The position element and type of data is required.

```

B001:DP
» Pos ( 1 , 1 )
NoData

```

- 4 ) Press the “OK” key having highlighted Pos( 1,1) and a X and Y interger can be entered using the “+” and “-” keys. The X and Y values represent the location coordinates for the displayed data. Press the “OK” key to accept the coordinate values..

```

B001:DP
Position
» X = 12
Y = 1

```

- 5 ) Using the “▲ and ▼” arrows highlight NoData. Press the “OK” key when ready.

```

B001:DP
» Strings
Analog In
FB Value
-----
TS Data
Date
Time

```



- 6 ) Highlight the Strings option using the “▲ and ▼” arrows and press the “OK” key to accept. Either a Flicker or Scroll option can be selected to represent the string. If neither is elected then a fixed position is indirectly chosen..

```
B001 : DP
Pos ( 12 , 1 )
» Flicker
Scroll
```

- 7 ) Press the “OK” key when either the Flicker or Scroll option is required. Set the Length (L) and the Time (T) of the string using the “+ and -” keys.

```
B001 : DP
Pos ( 12 , 1 )
L=      1
T=      0.0s
```

- 8 ) Press the “OK” key to enter the character string for the Display Function Block. A combination of “▲ and ▼” and the “◀ and ▶” arrows is needed to enter the entire string. Press the “OK” key to accept. .

```
B001 : DP
Pos ( 12 , 1 )
[ ■ ]
öùûü■! " # $
```

- 9 ) If Analog In data is required to be displayed press the “OK” when Analog In is highlighted in step 5. The following screen will be displayed. If an alternate Analog channel is being used, press the “+ and -” keys to select the correct channel..

```
B001 : DP
» Pos ( 12 , 1 )
Analog In
A01 : 0
```

- 10 ) Press the “OK” key with A01 channel is flashing and either a value or graph can be viewed for incoming analog data. Press the “OK” key for value and return to the previous screen , otherwise, highlight graph using the “▲ and ▼” and similarly press the “OK” key to set the graphical parameters.

```
B001 : DP
Analog In
» Value
Graph
```

- 11 ) The graph option allows graphical representation of data in the form of a horizontal bargraph, therefore, three parameters need to be entered to define the limitations. The Length (LEN) value of the bargraph can be entered using the “+ and -” keys. Use the “▲ and ▼” to highlight the MAX and MIN options accordingly. The Maximum (MAX) and Minimum (MIN) values can be entered using the “+ and -” keys. Refer to Table 6.16 for range settings for each parameter.

```
B001 : DP
LEN=      1
MAX=      0
MIN=      0
```

- 12 ) If a Function Block Value is required to be displayed press the “OK” when FB Value is highlighted in step 5.

```
B001 : DP
FB Select
Not Exist
Valid FB
```

13 )If a Time Switch is required to be displayed press the “OK” when TS Data is highlighted in step 5.

```
B001 : DP
TS Select
TimeSWm
B001
```

14 )If Date is required to be displayed press the “OK” when Date is highlighted in step 5.

```
B001 : DP
Pos ( 12 , 1 )
» Date
02 / 14 / 2002
```

15 )If a Time is required to be displayed press the “OK” when Time is highlighted in step 5.

```
B001 : DP
Pos ( 12 , 1 )
» Time
20 : 45
```

16 )Press the “ESC” key and return to the FBd for further programming.

### 6.17 Zone Compare Block

This function checks whether a value is within a specified range. There are three values - the Low Limit (L), Input Value (I), and High Limit (H). These values can be Set Directly, be Analog Inputs, or by Function Block values. The Output can be given a Set or Reset priority.

Set Priority - The Output turns ON when the Input Value is equal to or between the High and Low Limits.

Reset Priority - The Output turns ON when the Input Value is outside the High and Low Limits.

**Table 6.18: Zone Compare Function Block**

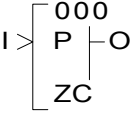
Function	Set Item	Description
	I	Input pin for zone compare operation
	FB	The following conditions apply to the function block: 1) Low (compare value L) a) DirectSet (Constant value): setting range -32768 to +32767 with an initial value 0 b) Analog In (Analog Input) : setting range A01 to A08 with an initial input A01 c) FB Value: output value from a function block 2) Input (input value I) a) DirectSet (Constant value): setting range -32768 to +32767 with an initial value 0 b) Analog In (Analog Input) : setting range A01 to A08 with an initial input A01 c) FB Value: output value from a function block 3) High (compare value H) a) DirectSet (Constant value): setting range -32768 to +32767 with an initial value 0 b) Analog In (Analog Input) : setting range A01 to A08 with an initial input A01 c) FB Value: output value from a function block
	Output	Output status: 1) ON in the zone The value from the input pin is compared with the preset high and low values and sets the output ON when the zonal compare condition is satisfied. Otherwise the output is OFF. 2) OFF in the zone The value from the input pin is compared with the preset high and low values and sets the output OFF when the zonal compare condition is satisfied. Otherwise the output is ON.

Setup of the Zone Compare Function Block directly from the α2 Series Controller

- 1 ) Allocate the input pin to be used for the function block.
- 2 ) Press the “OK” key with the cursor in the function block. The function block edit screen is displayed as shown.

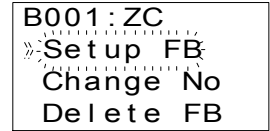

- 3 ) Press the “OK” Key and enter the function block settings using the “◀ and ▶” keys.

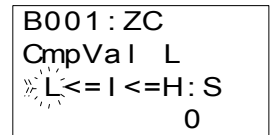

- 4 ) Pressing the “OK” invokes the input data type menu..

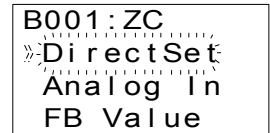

- 5 ) Press the “OK” Key and a DirectSet value can be entered.



- 6 ) Press the “OK” Key and an Analog Input in can be entered.

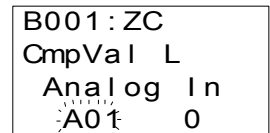

- 7 ) Press the “OK” key and data from another function block can be entered.

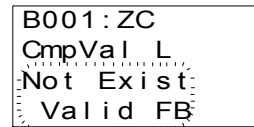

- 8 ) Having set the L and H condition using the same procedure and specified the Set or Reset while in zone compare area use the “ESC” key to return to the function block edit screen.

### 6.18 Schmitt Trigger Block

The Schmitt Trigger is used to compare an Input value against a specified high and low limits thus turn the Output ON/OFF when certain conditions are met. There are three values that must be set - the Input Value, the Low Limit and the High Limit. All three values can be either DirectSet, Analog In, or Function Block values. When the High Limit value is larger than the Low Limit value, the output will turn ON when the High Limit value is reached or exceeded. The Output will turn Off when the Input value is equal to or less than the Low Limit. (The Output does not turn OFF when the Input Value falls below the High Limit), eg. an air conditioner is set to turn ON when the air temperature reaches 23°C and turn OFF when the temperature reaches 18°C. The air conditioner is not constantly turning ON and OFF over slight temperature fluctuations.

When the High Limit value is less than the Low Limit value, the Output ON/OFF pattern is reversed. When the Input Value is greater than or equal to the Low Limit Value, the Output turns OFF. When the Input Value is equal to or less than the High Limit value, the Output comes ON. The input pin must be ON for the Function Block to register a new value from a Function Block or Analog Input. Therefore, the input pin must be ON for the status of the Output to change. The input pin does not have to be ON for the Output to be ON.

**Table 6.19: Schmitt Trigger Function Block**

Function	Set Item	Description
	I	Input pin for Schmitt Trigger operation
	FB	The following conditions apply to the function block: 1) Low (compare value L) a) DirectSet (Constant value): setting range -32768 to +32767 with an initial value 0 b) Analog In (Analog Input) : setting range A01 to A08 with an initial input A01 c) FB Value: output value from a function block 2) Input (input value I) a) DirectSet (Constant value): setting range -32768 to +32767 with an initial value 0 b) Analog In (Analog Input) : setting range A01 to A08 with an initial input A01 c) FB Value: output value from a function block 3) High (compare value H) a) DirectSet (Constant value): setting range -32768 to +32767 with an initial value 0 b) Analog In (Analog Input) : setting range A01 to A08 with an initial input A01 c) FB Value: output value from a function block The compare instruction is only performed if the input signal is ON.
	Output	Output Status: refer to the operation time charts for schmitt trigger condition.

1 ) High Value > Low Value

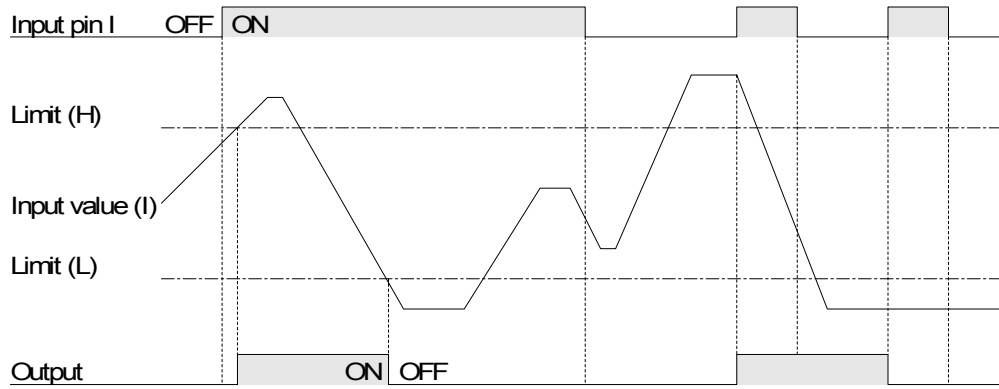

2 ) Low value > High value

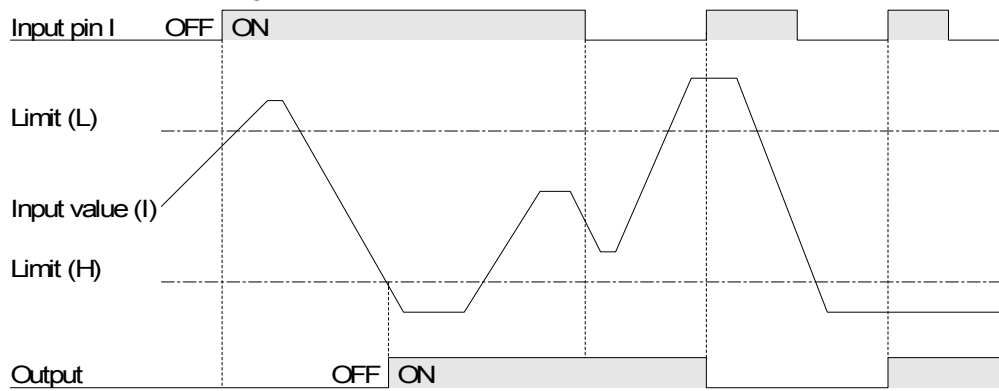

3 ) High value = Low Value

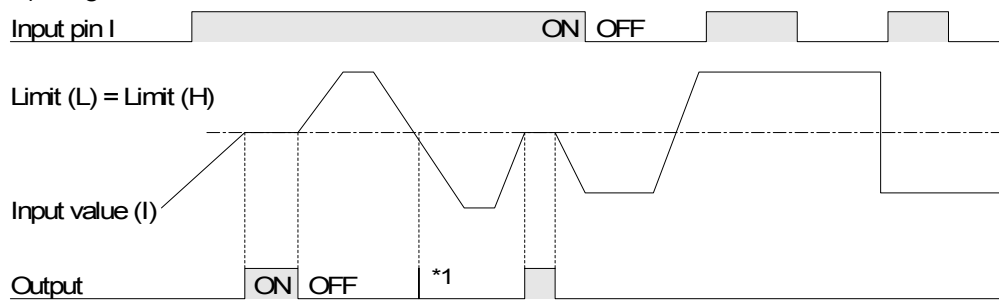

Note: \*1For Analog or FB value inputs, the lower and upper limits are not equal.

Setup of the Schmitt Trigger Function Block directly from the α2 Series Controller

- 1 ) Allocate the input pin to be used for the function block.
- 2 ) Press the “OK” key with the cursor in the function block. The function block edit screen is displayed as shown.

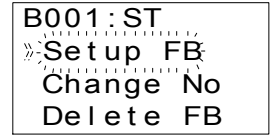

- 3 ) Press the “OK” Key and enter the function block settings using the “▲ and ▼” keys.

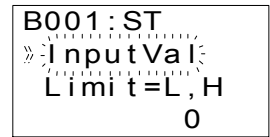

- 4 ) Press the “OK” key with the InputVal highlighted and the user can enter a the appropriate Input Val data from either a DirectSet, Analog In or other FB Values.

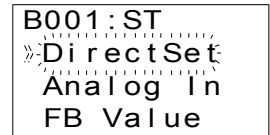

- 5 ) The Low and High limit can be given Input Val data from either a DirectSet, Analog In or other FB Values. Press the “ESC” key to return the edit screen for the function block and the user can change the low or high limits either by DirectSet, Analog In or FB Value.

### 6.19 Hour Meter Block

The Hour Meter is used to track the amount of time that a device has been in operation. This can be very useful for preventative maintenance schedules or for performing feasibility studies. The timing starts at the receipt of an Input signal and retains the accumulated time through system shutdowns or power failures. When the Set Time value is reached, the block Output will turn ON. The Hour Meter will continue recording time after the Output time is reached. A signal to the Clear pin will reset the current time value to zero.

**In the case of Ver. 3.00 or later**

The actual values of Hour Meter FBs (197-200) are saved to EEPROM.



The EEPROM can be written up to 10,000 times.

**Table 6.20: Hour Meter Function Block**

Function	Set Item	Description
	I	Input pin for hour meter operation
	C	Clear pin for function block
	FB	1) Time units are either hh:mm or mm:ss 2) Time setting range: a) 0-32767 hours with an initial value 0 b) 0 - 59 minutes with an initial value 0 c) 0 - 59 seconds with an initial value 0
	Output	1) The output is turned ON after the set time has elapsed. 2) The function block retains the previous value if there is no signal from the input pin and restarts with this value when the input is given a signal again. 3) The current time value is reset if the clear pin receives a signal. 4) The following items are available for other function blocks: a) In hh:mm setting <ul style="list-style-type: none"> <li>• Set Hour</li> <li>• Current Hour</li> <li>• Set Minute</li> <li>• Current Minute</li> </ul> b) In mm:ss setting <ul style="list-style-type: none"> <li>• Set Minute</li> <li>• Current Minute</li> <li>• Set Second</li> <li>• Current Second</li> </ul>



Hour operation time chart

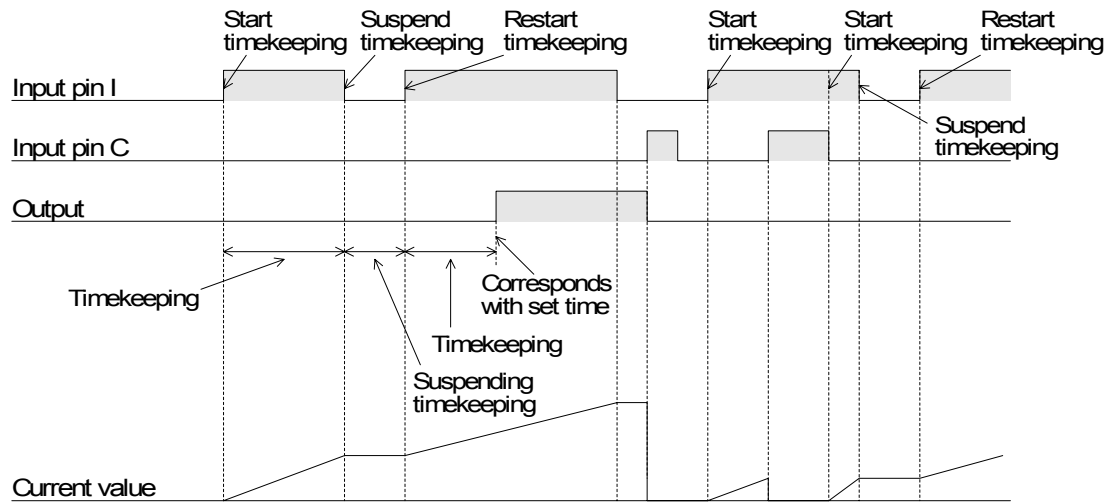

Setup of the Hour Meter Function Block directly from the α2 Series Controller

- 1) Allocate the input pin to be used for the function block.
- 2) Press the “OK” key with the cursor in the function block. The function block edit screen is displayed as shown.

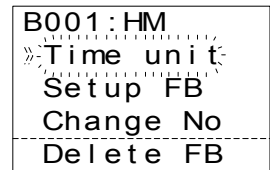

- 3) Press the “OK” key to set the Time unit for the delayed output.

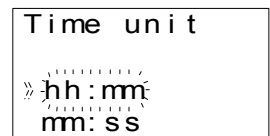

- 4) Press the “OK” key having selected the correct time unit and return to the function block edit screen. Using the “▲” and “▼” keys highlight the Setup FB and press the “OK” key.

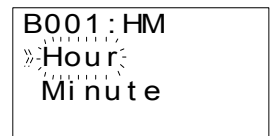

- 5) Press the “OK” key with Hour highlighted and using the “▲”, “▼”, “+” and “-” Keys enter the total hour time for the specified block.

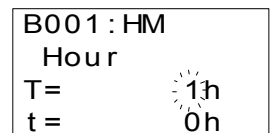

- 6) Press the “OK” key with Minute highlighted and using the “▲”, “▼”, “+” and “-” Keys enter the total minute time for the specified block.

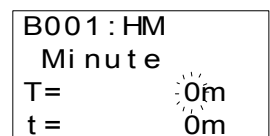

## 6.20 Speed Detect Block

The function block measures the signal input frequency for a set user defined period of time. The frequency is constantly compared to a preset high and low threshold values and the output is set ON if the conditions are satisfied. The speed detect function block is used to count incoming pulses, however, for normal inputs without the AL2-4EX expansion module connected the incoming pulses are restricted to 20Hz. The AL2-4EX, with inputs EI1 or EI2, expansion module allows for 1KHz incoming pulses to be measured.

**Table 6.21: Speed Detect Function Block**

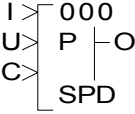
Function	Set Item	Description
	I	Input pin for speed detect function block
	U	Count incoming signal
	C	Clear pin for function block
	FB	<p>The function block counts incoming pulses when the input is ON. When the input signal is OFF, the actions to count the pulses of the counter input and compare the speed with upper and lower threshold limit will stop.</p> <p>1) Speed and output values will not be cleared unless the clear pin receives a signal to reset the counter.</p> <p>2) Upper limit &gt; Lower limit: The output signal will be OFF when the speed output value is equal to or less than the lower limit value. If the speed output value is equal to or larger than the upper limit value the output status will be ON. Otherwise the output signal does not change.</p> <p>3) Lower limit &gt; Upper limit The output signal will be OFF when the speed output value is equal to or larger than the lower limit value. If the speed output value is equal to or less than the upper limit value the output status will be ON. Otherwise the output signal does not change.</p> <p>4) Lower limit = Higher limit The output status is ON if the Speed Output = Lower limit = Upper limit. Otherwise the output signal is OFF.</p> <p>5) Function Block data: a) Period setting value: 1 to 32767</p>
Output	<p>Output status: refer to the speed detect time charts for output status.</p> <p>1) The following items are available for other function blocks: a) Set Period b) Current Period</p>	



Note: The Speed Detect function (SPD) block can use only 1 high speed frequency (Max. 1kHz) in any one program. Subsequent SPD function blocks can only use a maximum of 20Hz for high speeding counting.

1) Upper limit > Lower limit

Normal input max. 20Hz

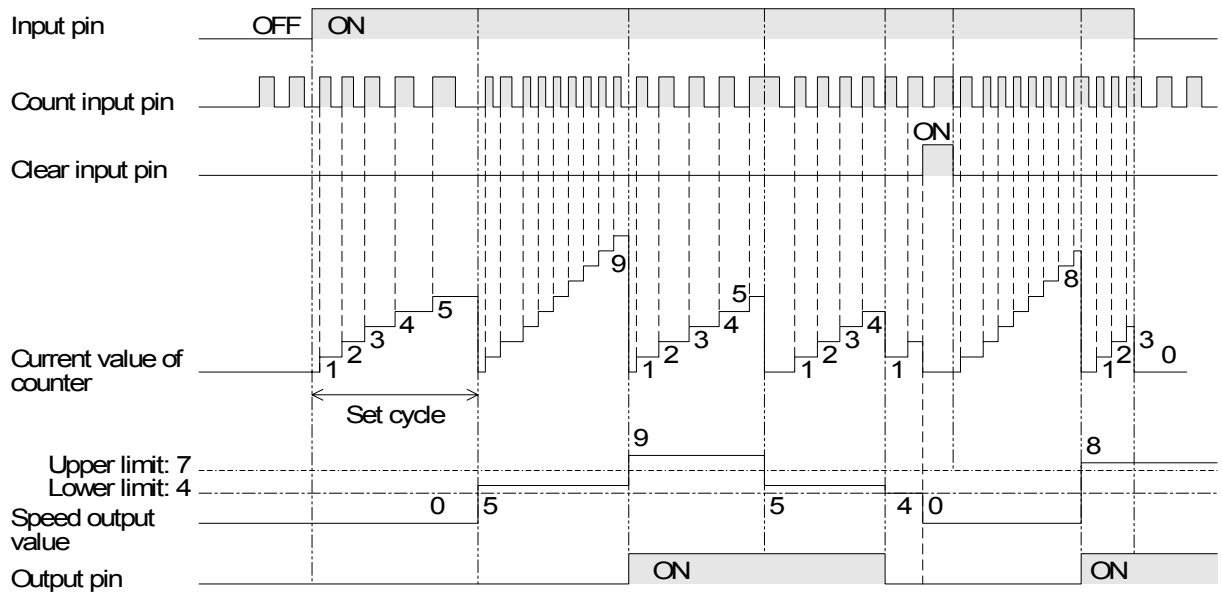

Interrupt input terminal for AL2-4EX max.1kHz

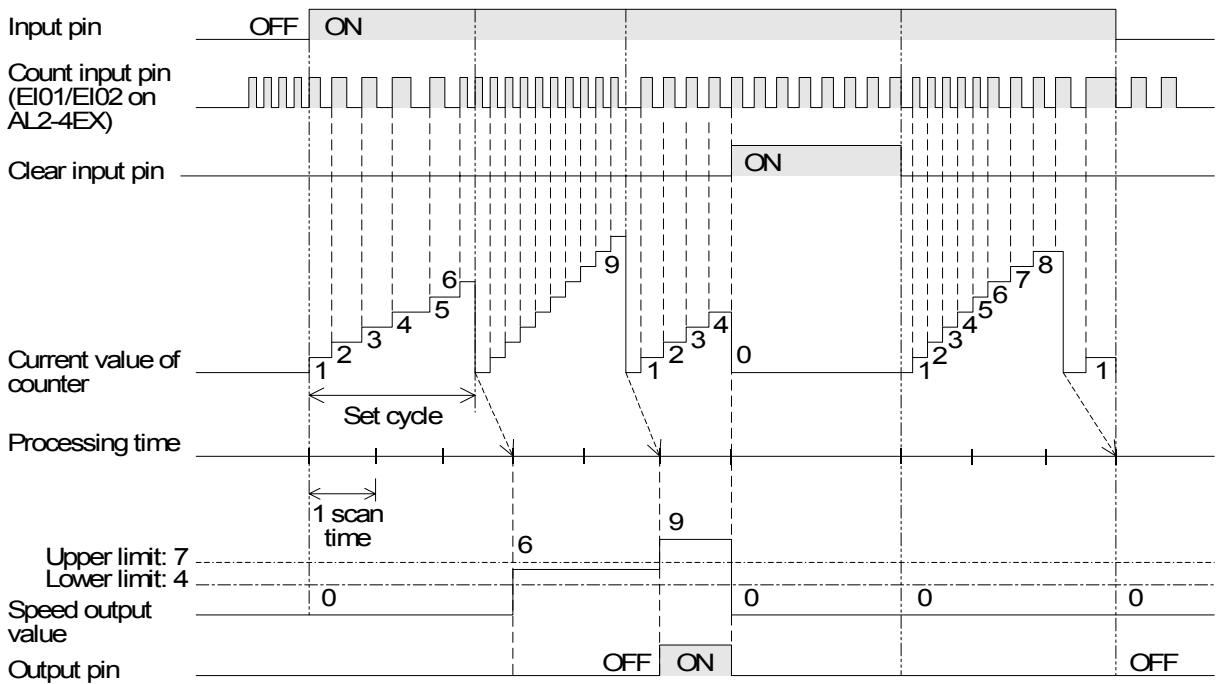

2 ) Upper limit < Lower limit

Normal input max. 20Hz

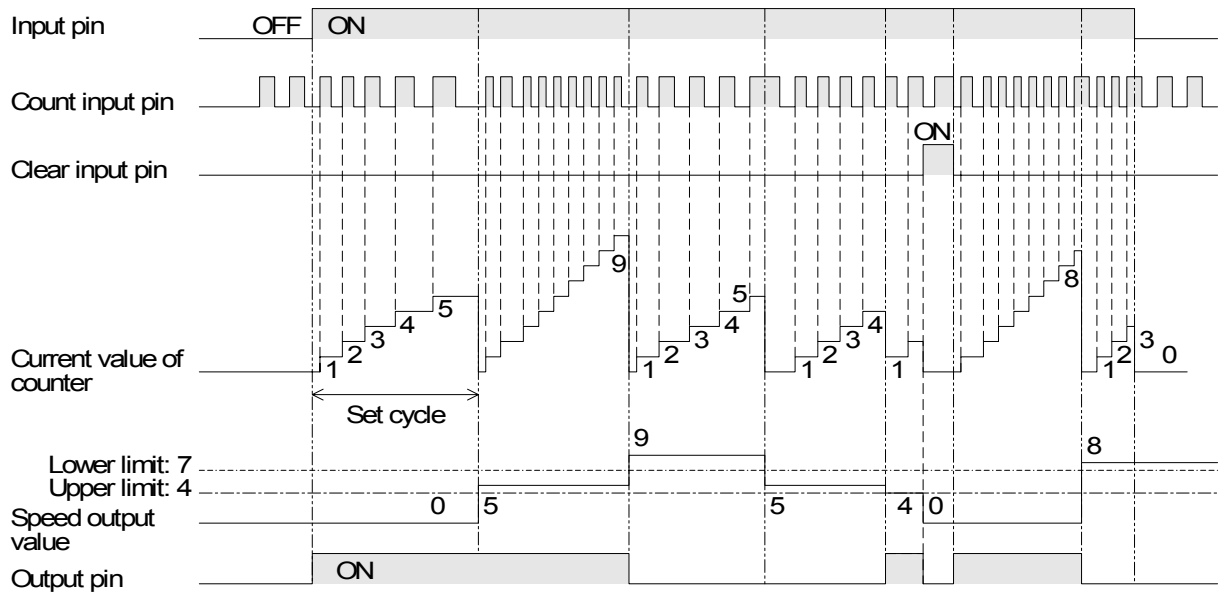

Interrupt input terminal for AL2-4EX max. 1KHz

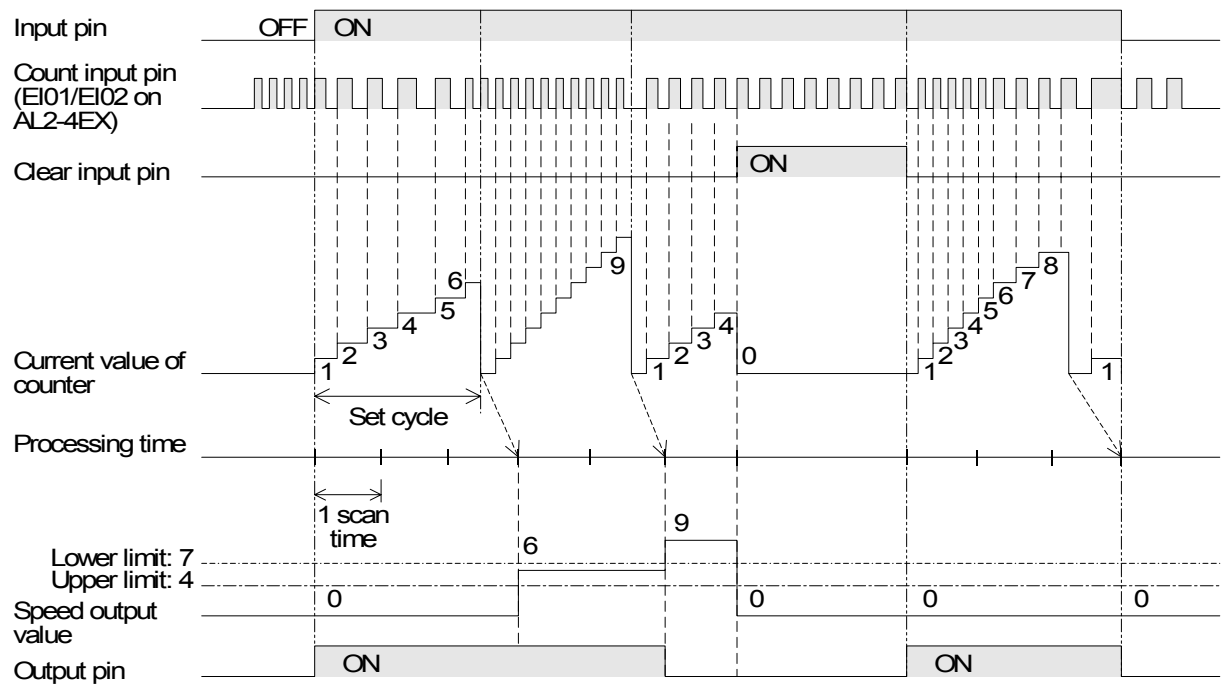

3 ) Upper limit = Lower limit

Normal input max. 20Hz

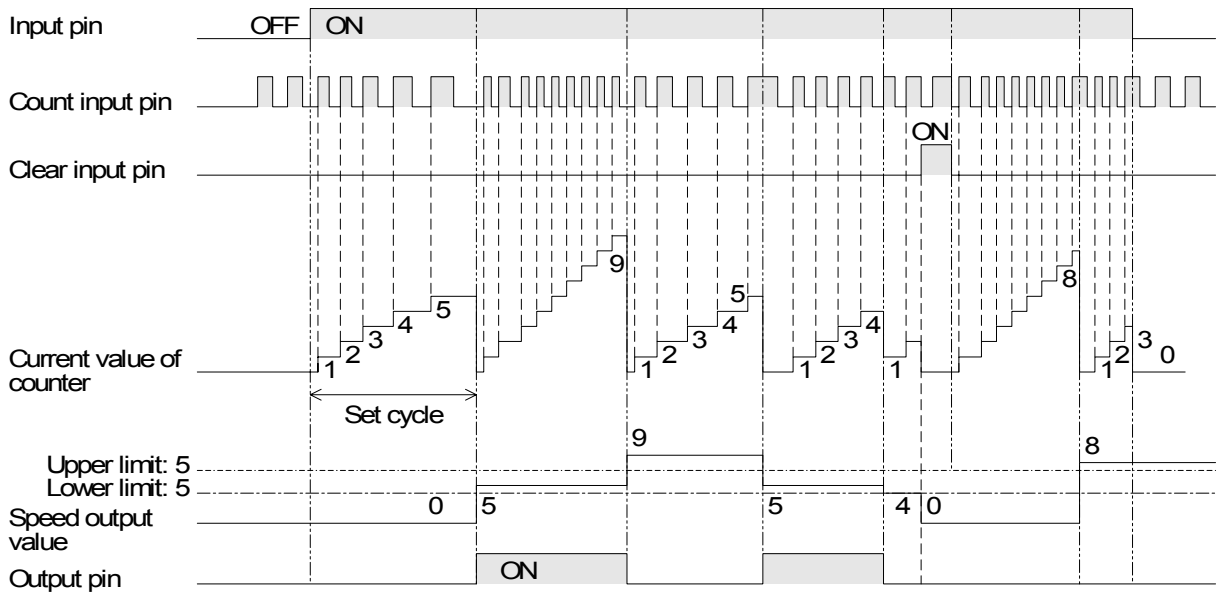

Interrupt input terminal for AL2-4EX max 1KHz

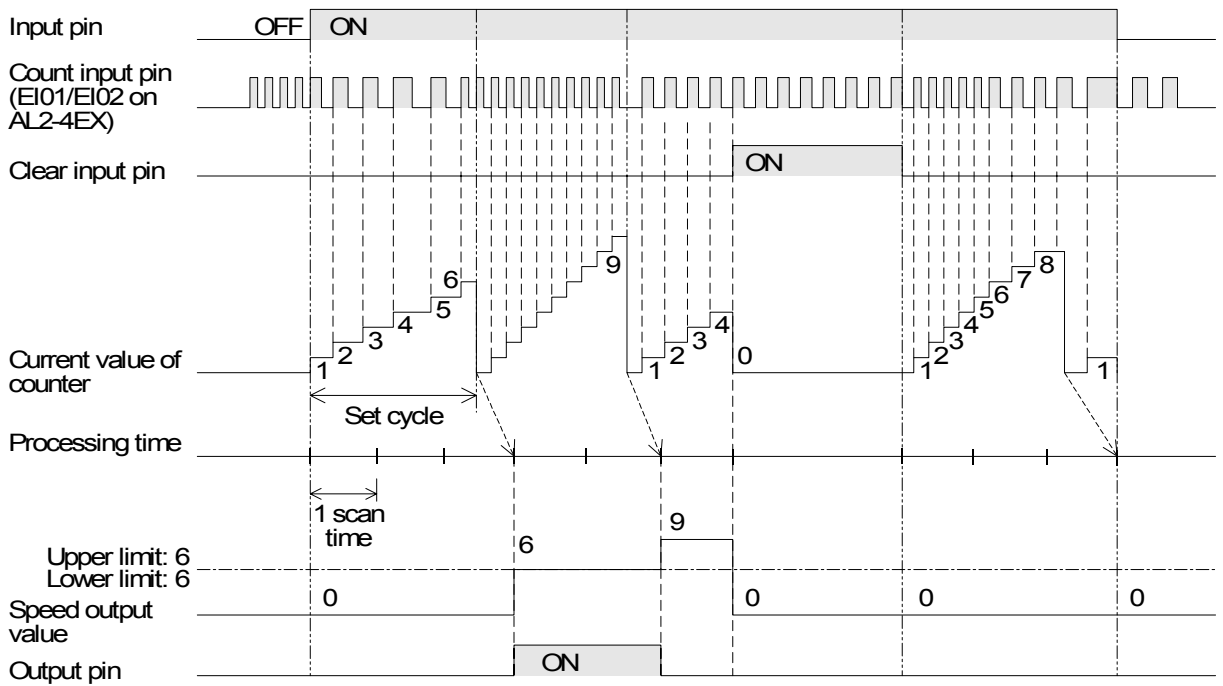

Setup of the Speed Detect Function Block directly from the α2 Series Controller

- 1 ) Allocate the input pin to be used for the function block.
- 2 ) Press the “OK” key with the cursor in the function block.  
The function block edit screen is displayed as shown.

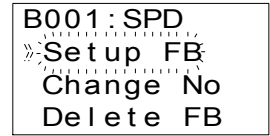

- 3 ) Press the “OK” Key and enter the function block settings using the “▲ and ▼” keys.

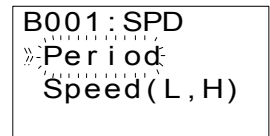

- 4 ) Press the “OK” key with Period highlighted and the user can enter a T and t value using the “▲, ▼, + and -” keys.

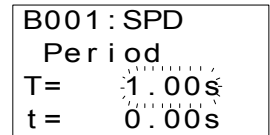

- 5 ) Press the “OK” key to return to the function block settings screen. Highlight the Speed(L,H) option using the “▲ and ▼” keys. The limits can be set by highlighting L or H and pressing the “OK” key. A Directset value, Analog In or FB value can be entered.

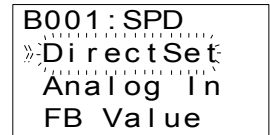

- 6 ) Press the “ESC” key until the user returns to the function block diagram.

## 6.21 Pulse Width Modulation

The function block emits a continuous pulse train output when an input is given at a preset duty cycle.

**Table 6.22: Pulse Width Modulation**

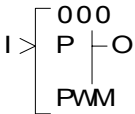
Function	Set Item	Description
 <p>The diagram shows a function block with an input 'I' and an output 'O'. The block is labeled 'P' and 'Pulse Width Modulation'.</p>	I	Input pin for the pulse width modulation function block
	FB	1) The PWM function operates concurrently with the input pin status set ON. 2) The width of the pulse is dominated by the duty and value of the period. 3) Duty (setting range:0-100%) a) DirectSet (Constant value): setting range 0 to 100 with an initial value 0 b) Analog In (Analog Input) : setting range A01 to A08 with an initial input A01 c) FB Value: output value from a function block 4) The period is restricted to a setting range: 1 to 32767 x 100ms (*Note)
	Output	The function block is used to control the width of the output pulse based on a specified period of time and duty. 1) The bit output pin is set on for the length of the duty specified. 2) The following items are available for other function blocks: a) Set Period b) Current Period



**Note:**

The ON/OFF time cannot be less than one scan time for the controller; otherwise, the PWM Function Block will not perform its assigned task for the time specified. Users can monitor the scan time from the α2 Series Controller. Scan time is dependent on the user-program; therefore, caution is needed as and when time units are selected.

1) PWM operation time chart.

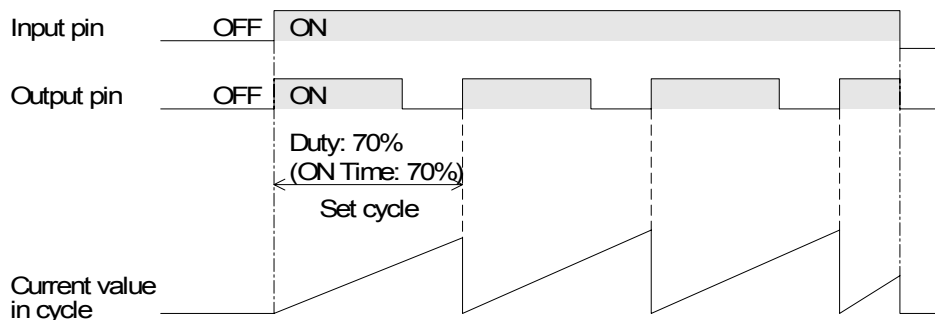

**Note:**

10ms step for minimum resolution.

Setup of the Pulse Width Modulation Function Block directly from the α2 Series Controller

- 1 ) Allocate the input pin to be used for the function block.
- 2 ) Press the “OK” key with the cursor in the function block. The function block edit screen is displayed as shown.

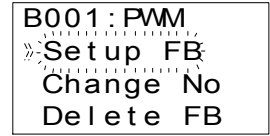

- 3 ) Press the “OK” Key and enter the function block settings using the “▲ and ▼” keys.

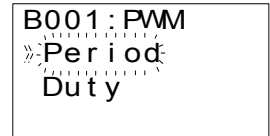

- 4 ) Press the “OK” key with Period highlighted and the user can enter a T and t value using the “▲, ▼, + and -” keys.

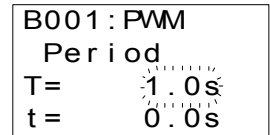

- 5 ) Press the “OK” key to return to the function block settings screen. Highlight the Duty option using the “▲ and ▼” keys. The Duty can be entered by pressing the “OK” key. A Directset value, Analog In or FB value can be entered.

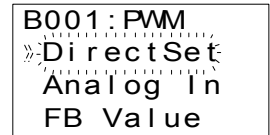

Press the “ESC” key until the user returns to the function block diagram.



## 6.22 PID Block

The PID Function Block contains the α2 implementation of PID, a control method used to obtain stable control over a system variable. The chapter describes, in detail, the necessary parameter adjustments for using the PID Function Block properly. A simpler alternative is to run the Auto-tuning function, which automatically adjusts the parameters for the specific system. The following terms will be used throughout this chapter, Process Value (PV), Set Value (SV) and Manipulated Value (MV). The PV is the current measured value of the system parameter that PID is controlling. SV is the desired value of the parameter being controlled and MV is the output of the PID Function Block used to drive the PV to the SV. Up to 20 PID Function Blocks may be used in a program.

**Table 6.23: PID Block**

Function	Set Item	Description
	E	Enable pin for the PID Block. The Error output is reset when the pin goes OFF. If left unconnected, the function block will always be enabled.
	A	Starts Auto-tuning on the transition from OFF to ON. If the pin is unconnected it is considered OFF.
	C	Clears all output signals and stops Auto-tuning, when turned ON. If left unconnected, the pin is considered to be OFF.
	SV	The word input pin for the set value. If left unconnected a set value of 0 is used in the control calculations.
	PV	The word input pin for the process value. If left unconnected a process value of 0 is used in the control calculations.
	FB	Refer to the Timing Diagrams and Parameter Settings below.
	Output	1) AT RUNNING turns on when auto-tuning is in operation. 2) The following outputs are available for other function blocks: a) MV (Manipulation Value) b) ERROR CODE

### PID Function Block Operation - Timing Diagrams

1) PID Operation when Auto-tuning has finished normally.

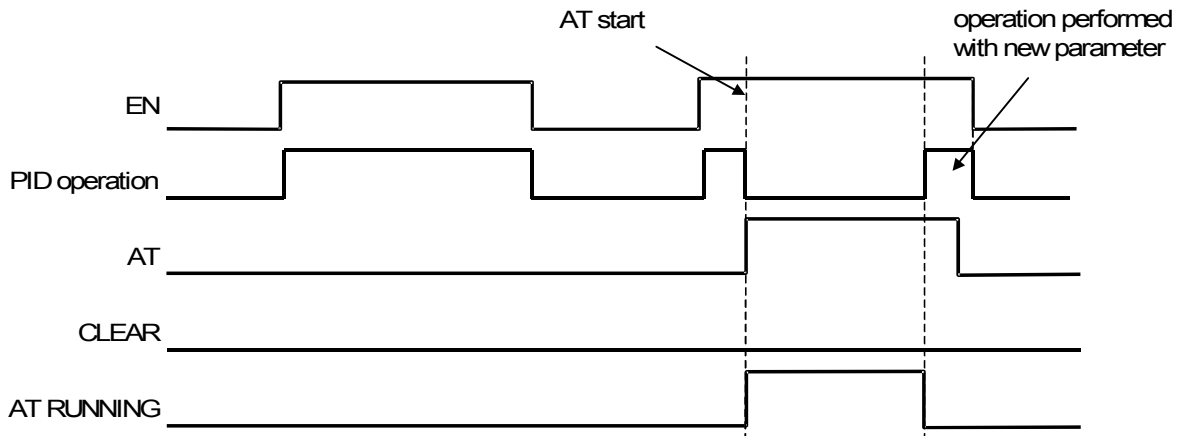

2) PID Operation when Auto-tuning was interrupted

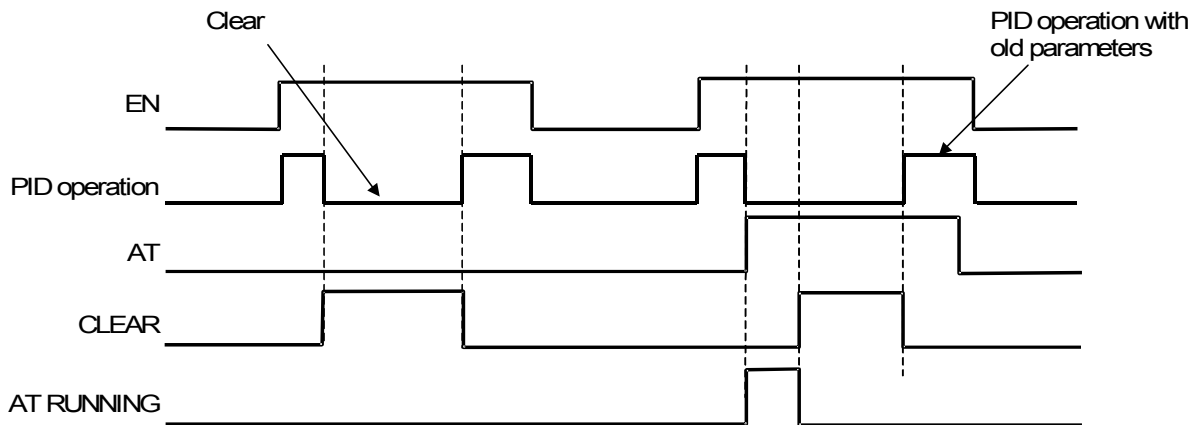

3) Error Occurance

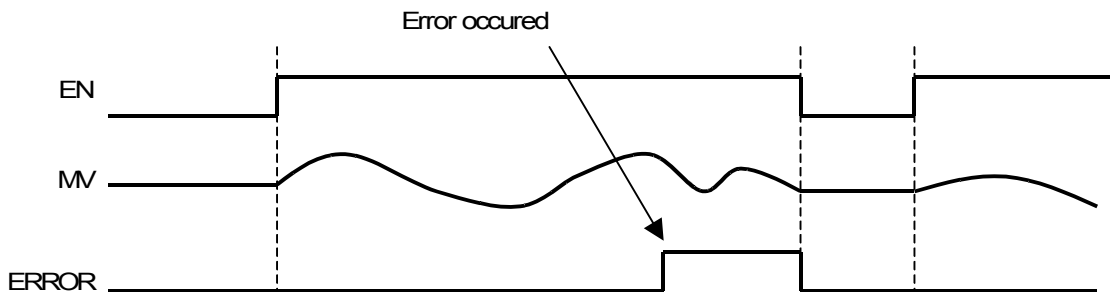

6.22.1 Parameter List and PID Details.

Table 6.24: List of the PID Parameters,

Parameter	Parameter Description	Range	Default	Unit
SV	Set Value	-32768 - 32767	0	
PV	Process Value	-32768 - 32767	0	
MV	Manipulated Value	0 - 4000	0	
TS	Sampling time	1 - 32767	50	10 ms
KP	Proportional gain	1 - 32767	75	0.1% <sup>1</sup>
				0.01% <sup>2</sup>
TI	Integration time	0 - 32767	40	100 ms
KD	Derivative gain	0 - 100	50	%
TD	Derivative time	0 - 32767	100	10 ms
α <sub>f</sub>	Noise filter	0 - 99	50	%
ULV	Output upper limit value (ULV)	LLV - 4000	4000	
LLV	Output lower limit value (LLV)	0 - ULV	0	
AT Bias	Auto-tuning Bias	-32768 - 32767	0	
Direction	Direction of operation	forward or reverse	reverse	
Control Response	Control response parameter	fast, normal, slow	normal	
PID control after AT	PID control after auto-tuning completes	P, PI, PID	PID	

1. Units of 0.1% are used for analog inputs, FB word outputs, and temperature inputs using a Celsius scale.

2. Units of 0.01% are used for temperature inputs using a Fahrenheit scale.

**Table 6.25: PID Equations**

Filtered Process Value	$PV_{fn} = PV_n + \alpha_f (PV_{fn-1} - PV_n)$
Filtered Set Value	$SV_{fn} = \frac{1}{T_S + \beta T_I} (T_S SV_n + \alpha \beta T_I (SV_n - SV_{n-1}) + \beta T_I SV_{fn-1})$
Deflection (Error Value)	$EV_n = PV_{fn} - SV_{fn}$
Integration Value	$I_n = \frac{T_S}{T_I} EV_n$
Derivative Value	$D_n = \frac{T_D}{T_S + K_D T_D} (PV_{fn} - 2PV_{fn-1} + PV_{fn-2} + K_D D_{n-1})$
Control Value Change in Forward Operation	$\Delta MV_n = K_P ((EV_n - EV_{n-1}) + I_n + D_n)$
Control Value Change in Reverse Operation	$\Delta MV_n = -K_P ((EV_n - EV_{n-1}) + I_n + D_n)$
Manipulation Value	$MV_n = \sum \Delta MV_n$

**Table 6.26: List of Additional Variables used in the PID equations**

Variable	Description
EV <sub>n</sub>	Deflection for current sample
EV <sub>n-1</sub>	Deflection of previous sample
I <sub>n</sub>	Integration Value for current sample
K <sub>D</sub>	Derivative Gain
K <sub>P</sub>	Proportional Gain
MV <sub>n</sub>	Output Value for current sample (Manipulated Value)
PV <sub>fn</sub>	Measured Value (filtered) for current sample
PV <sub>fn-1</sub>	Measured Value (filtered) for previous sample
PV <sub>fn-2</sub>	Measured Value (filtered) for two samples ago
PV <sub>n</sub>	Measured Value for current sample
SV <sub>fn</sub>	Set Value (filtered) for current sample
SV <sub>fn-1</sub>	Set Value (filtered) for previous sample
SV <sub>n</sub>	Set Value for current sample
SV <sub>n-1</sub>	Set Value for previous sample
T <sub>D</sub>	Derivative Time

**Table 6.26: List of Additional Variables used in the PID equations**

Variable	Description
$T_I$	Integration Time
$T_S$	Sample Time
$\Delta MV_n$	Change in Manipulated Value for the current sample
$\alpha$	Proportional gain coefficient (See Control Response)
$\alpha_f$	Input value filter coefficient
$\beta$	Integration time coefficient (See Control Response)

### 6.22.2 Setting the Input Values, SV and PV

**Set Value, SV.** SV is the target value for the system parameter under PID control. The SV pin on the Function Block accepts a constant, a value from an analog/temperature input or a word output from another Function Block. This value can be changed during PID operation. A change during Auto-tuning has no effect.

**Process Value, PV.** The PV is the current measured value of the system parameter under PID control. The PID Function Block output drives the PV toward the SV when PID control is operating correctly. The PV field should contain the appropriate signal from the system under PID control.

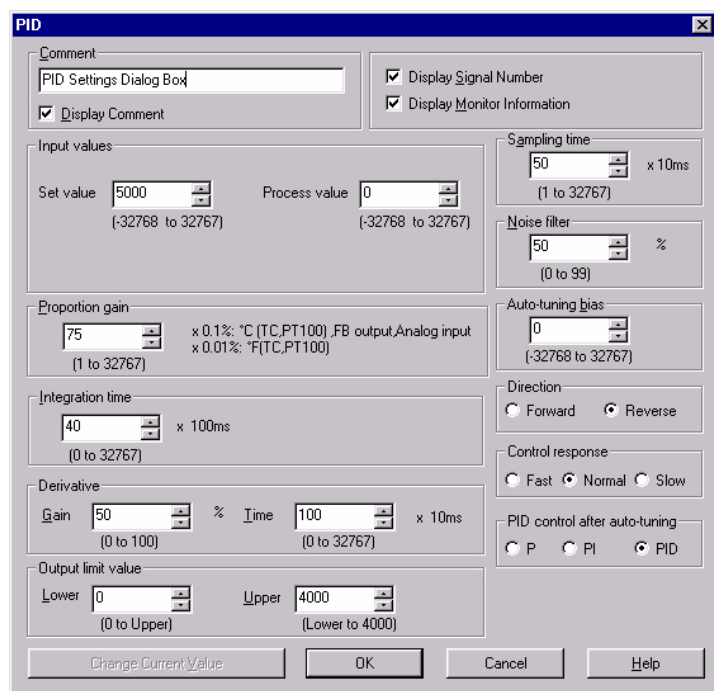

### 6.22.3 Setting the Function Block Parameters

**Proportional Gain,  $K_P$ .**  $K_P$  scales the magnitude of the MV. If only proportional control (P-control without I- or D-control) is used, the Manipulated Value is purely dependent on the change in deflection. (Deflection is the difference between the current state and the desired state, also known as error value.) If PI- or PID-control is used, then the MV will depend on other factors as well as deflection. The change in deflection between two adjacent sample points is essentially a measure of how fast the Process Value is moving toward the SV. It is not simply the difference between the current state,  $PV_{nf}$  and the desired state,  $SV_{nf}$ . The  $K_P$  parameter can be set manually or automatically with the Auto-tuning function. The default value for  $K_P$  is 75 with a possible setting range of 1 to 32767. The units of  $K_P$  depend on the type of word data that is used. See the table below for the units. A small  $K_P$  causes the PV to rise slowly, to stabilize slowly and to overshoot less. See section 6.22.5 for more information on the formulas used for determining the system parameters during Auto-tuning.



**Note:**

Other PID systems may calculate proportional control based on the magnitude of the current deflection only.

**Table 6.27: Units for  $K_P$**

Units	Type of Word data	Default Value	Range
0.1%	· Analog input · Function Block word output · Temperature input using the Celsius scale.	7.5%	0.1% to 3276.7%
0.01%	· Temperature input using the Fahrenheit scale	0.75%	0.01% to 327.67%

**Figure 6.22a. Characteristic response for different  $K_P$  parameters**

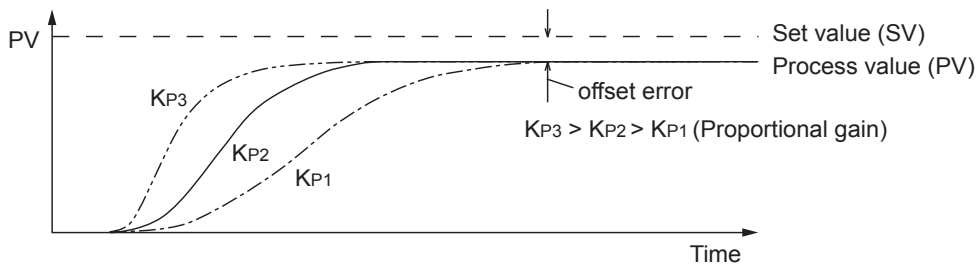

**Integration Time,  $T_I$ .** A common problem with P-control is that it tends to stabilize the PV at a value not equal to the SV (this is called an offset error). With PI-control, a temporal integration factor is added to deal with this problem. The idea behind PI-control is to ramp up the effect of P-control, if an offset error persists over time. The  $T_I$  parameter can be set manually or automatically with the Auto-tuning function. The default value for  $T_I$  is 40 (4 seconds) but can be set to any value within the range of 1 to 32767 (in 100ms units). When a small value for  $T_I$  is set, the PV will reach the SV within a relatively short amount of time with greater searching (e.g. more overshoot and more undershoot) for the SV.



**Note:**

Setting zero for this variable disables the integration effect.

**Figure 6.22b. Characteristic response for different  $T_I$  parameters**

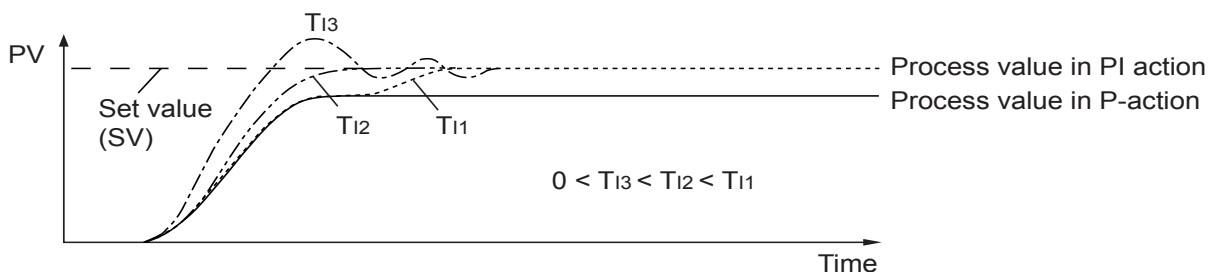

**Derivative Time and Derivative Gain,  $T_D$  and  $K_D$ .** D-control acts together with the proportional part of PID-control. For changes in the PV, the Derivative component will supplement the P-control depending on the rate of change of the PV. Derivative Control initially outputs a large corrective action which dissipates rapidly over time. The outcome is that the PV reaches the SV more quickly and does not fluctuate as much as with PI-control. There are two ways to adjust the Derivative control of the PID Function Block, Derivative Time ( $T_D$ ) and Derivative Gain ( $K_D$ ).  $T_D$  can be set manually or automatically with the Auto-tuning function. The default value for  $T_D$  is 100 (1 second) but can be set to any value within the range of 1 to 32767 (in 10ms units). For small values of  $T_D$ , D-control will have a small effect. For large values, there will be a short stabilization time with some searching (overshoot and undershoot) for the SV. The second parameter,  $K_D$ , cannot be set by the Auto-Tuning function and should be adjusted manually. The default value for  $K_D$  is 50% but can be set to any value within the range of 0 to 100%. Increasing  $K_D$  will make the D-control more responsive (shorter stabilization time) to sharp changes in PV.

**Figure 6.22c. Characteristic response for different  $T_D$  parameters**

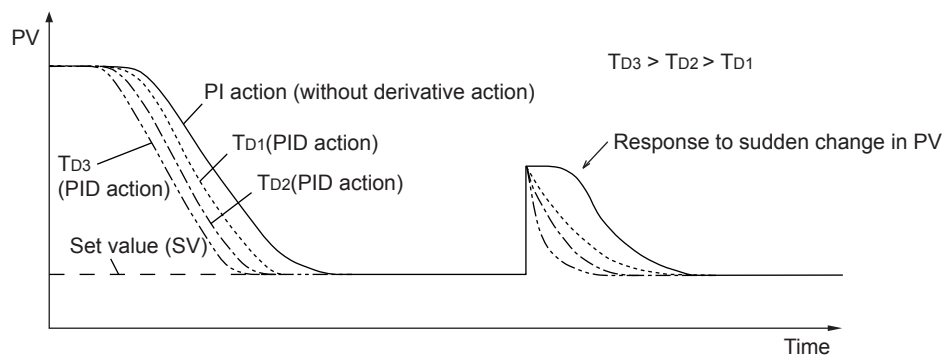

**Sampling Time,  $T_S$ .**  $T_S$  is the period of time between two measurements of the PV. Values for  $T_S$  range from 1 to 32,767 (in 10ms units). The default value for  $T_S$  is 50 (500 ms).

**Noise Filter,  $\alpha_f$ .** The  $\alpha_f$  coefficient determines the level at which the PID Function Block ignores noise from the input sensors on the input signal, PV. The coefficient can be adjusted to a value ranging from 0 to 99%. Setting  $\alpha_f$  to 0% disables the filter and passes the raw PV ( $PV_n = PV_{nf}$ ) to the PID calculations. The default value for  $\alpha_f$  is 50%.

**Auto-tuning Bias, AT Bias.** This value is an offset applied to the SV during Auto-tuning. The SV, plus the AT bias, is the threshold during Auto-tuning where the output is switched from on to off. During the Auto-tuning calibrations, the MV will be turned OFF when the PV passes the “SV plus AT bias” point and not the usual SV point (without AT bias). Refer to the Auto-tuning section for more details. The allowable range for the AT bias is -32768 to 32767. The default value for AT bias is 0.



**Note:**

In some cases, a physical limitation may make it undesirable for PV to exceed SV too greatly. This feature is useful in those applications that require that the PV stay below (or above) the actual SV. AT-Bias allows the user to offset the SV to a point where overshooting and undershooting may occur without undesirable results.

**Direction.** The direction of the system refers to the response of the PV as the MV is applied. If an MV is applied and the response of the PV is in the positive direction, the system is said to be a “Reverse” type system. Whereas, if a the PV responds in the negative direction then the system is a “Direct” type of system. The default setting for Direction is “Reverse.”

**Control Response.** When changes in the SV are necessary, the user can select whether the changes from the initial SV to the final SV should be immediate or gradual. There are three options for speed at which SV changes: slow, normal and fast. With immediate, or fast, response, the controller tends to overshoot its target. With Normal Response there is less overshoot. And, finally, with Slow Response, there should be no overshoot at all.

**Table 6.28: Coefficient Values for Different Response Times**

Response	$\alpha$	$\beta$
FAST	100%	100%
NORMAL	40%	135%
SLOW	0%	100%



**Note:**

In certain systems, changing this parameter will have no effect on the response behavior of the controller.

**PID Control after Auto-tuning. P, PI, PID.** The controller can be setup to run in one of three modes: P-control, PI-control or PID-control. The desired control type will only become effective after auto-tuning has completed. The choice of control type should be made depending on the application. For example, if P-control is a sufficient control method for the application, then the more resource-intensive I- and D-control can be switched off to shorten the scan time.

**Changing the MV Current Value.** This function is only available in the VLS Programming Language. Click “Change Current Value” to force the MV to another value. This function is useful when manually fine tuning the PID parameters.

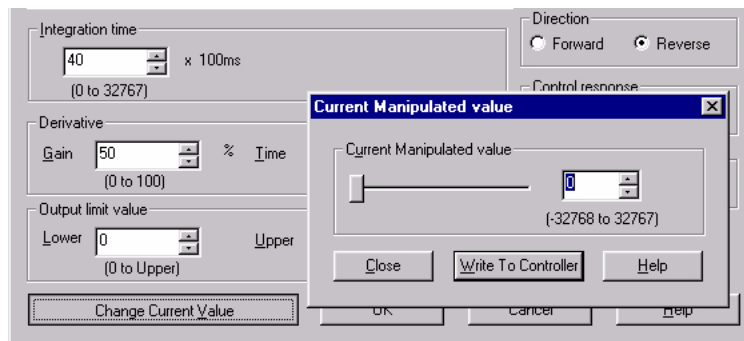

**6.22.4 Limiting the Manipulated Value**

The PID function block dialog box contains an area for setting upper (ULV) and lower limits (LLV) for the output, or the MV. Possible LLVs range from 0 to the ULV and possible ULVs range from the LLV to 4000.

**Figure 6.22d. MV with Upper and Lower Limits**

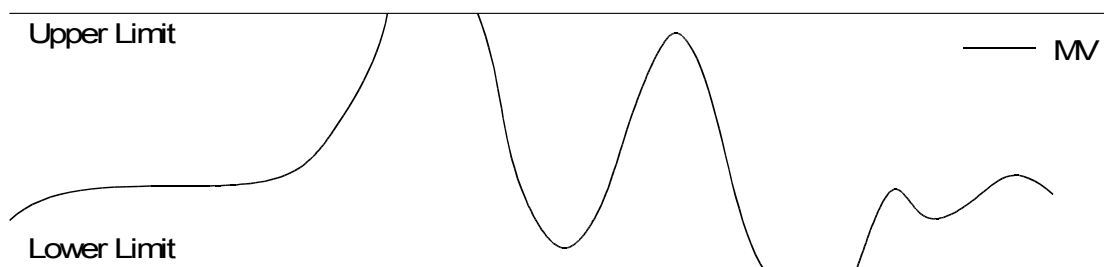

### 6.22.5 Setting $K_P$ , $T_I$ , and $T_D$ with Auto-tuning

Auto-tuning can automatically calculate and set the  $K_P$ ,  $T_I$ , and  $T_D$  control parameters, eliminating the need for the user to set them manually. Auto-tuning measures and uses the characteristic responses of the system to determine the parameter settings for the PID function block. See the Timing Diagrams above for correct usage.

The output, or MV, is driven to its upper limit value until the PV reaches the SV (plus the AT bias, if there is one), then it is driven to zero until the PV reaches the SV again. This is repeated several times.

**Figure 6.22e. Auto-tuning for Direction type, Reverse (default).**

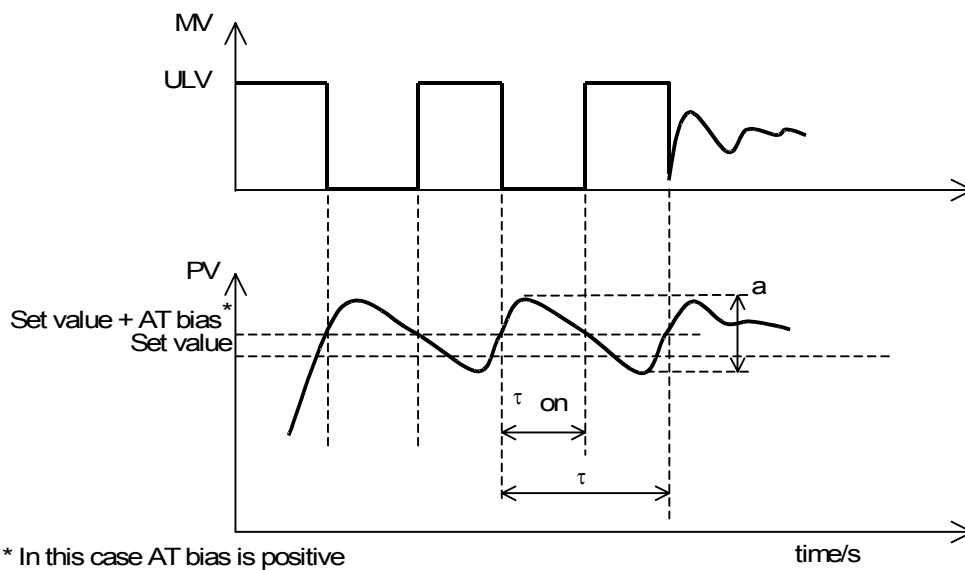

**Figure 6.22f. Auto-tuning for Direction type, Direct.**

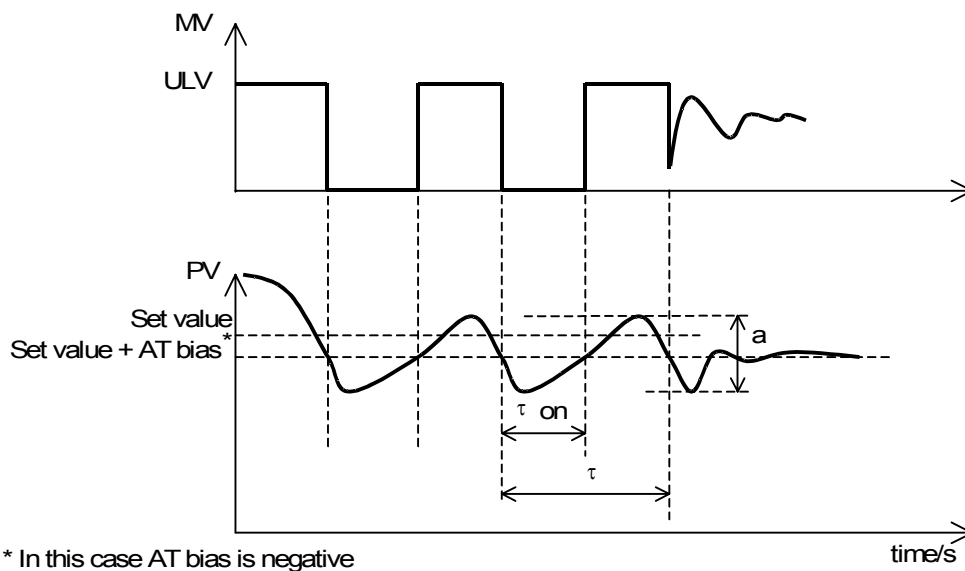

The figures above indicate the behavior of the MV and the PV for a Reverse Direction example system and a Direct Direction example system. During Auto-tuning, the MV is driven to its upper limit value and to its lower limit value periodically and the response of the PV is monitored. The controller then calculates the parameters,  $K_P$ ,  $T_I$ , and  $T_D$ , from the behavior of the PV over time.



The controller then records the way that the PV behaves and derives the correct parameter using the Ziegler and Nichols formulas below. See Figures 6.22e and 6.22f for the definitions of  $a$ ,  $\tau$  and  $\tau_{on}$ .

**Table 6.29: The Ziegler and Nichols formulas**

	<b>P</b>	<b>PI</b>	<b>PID</b>	<b>Unit</b>
Proportional gain $K_p$	$\frac{1}{a}$	$\frac{0.9}{a}$	$\frac{1.2}{a}$	1
Integration time $T_i$	0	$33\tau_{on} \left(1 - \frac{\tau_{on}}{\tau}\right)$	$20\tau_{on} \left(1 - \frac{\tau_{on}}{\tau}\right)$	100 ms
Derivate time $T_D$	0	0	$50\tau_{on} \left(1 - \frac{\tau_{on}}{\tau}\right)$	10 ms

See figures 6.22e and 6.22f for the definitions of  $a$ ,  $\tau$  and  $\tau_{on}$ .

Consequently, if the system is moderately linear, the Auto-tuned parameters will be sufficient to control the PV if the SV is changed. Auto-tuning will not need to be performed again.

The following parameters should be adjusted before starting the Auto-tuning:

- Direction of operation (to ensure that MV drives PV in the correct direction)
- Set Value (Changes during Auto-tuning are not effective.)
- Sample Time (Must be larger than the maximum system scan time!)
- Noise filter
- Desired control characteristic after Auto-tuning (P-, PI- or PID-control)
- Output Upper and Lower limit values
- AT bias

The following parameters may also be set before Auto-tuning, but they do not influence the process:

- Derivative gain
- Control Response type (fast, normal, slow)



Note concerning the VLS Programming Language: Upon the completion of Auto-Tuning, the program in the controller will be updated with the new PID parameters. If VLS was monitoring the controller before the Auto-Tuning function was started, monitoring will STOP, a message box will appear and VLS will return to the Editing mode. The updated program must be uploaded to the PC to begin monitoring again.

### 6.22.6 PID Troubleshooting

For some systems, the Parameter values derived from the Auto-tuning process will be less than optimal. If Auto-Tuning derives such parameter values, the user should refer to the descriptions above for each relevant parameter ( $K_P$ ,  $T_I$ , and  $T_D$ ) or see the following guide to adjust these parameters.

Response when  $K_P$  is decreased:

The PV rises slowly, stabilizes slowly with no overshoot.

Response when  $T_I$  is increased:

The PV stabilizes slowly with less searching (overshoot and undershoot) for the SV.

Response when  $T_D$  is increased:

The PV stabilizes quickly. There is more searching (overshoot and undershoot) for the SV.

### 6.22.7 Error Codes

Error Codes are reported by the PID Function Block via the string output pin. The error code byte consists of 8 error flags, but only the lower 6 bits are functional. An error code value of zero means there is no error.

**Table 6.30:**

Bit	Content	State of processing
b0	Sampling time < (system) scan time	PID operation continued
b1	Filtered PV change overflow ( $\Delta PV_{fn} < -21692$ or $\Delta PV_{fn} > 21692$ )*1	
b2	Deflection overflow ( $EV < -32768$ or $EV > 32767$ )	
b3	Integration result overflow (out of range: [-32768, 32767])	
b4	Derivative overflow (out of range: [-32768, 32767])	
b5*2	Internal error during auto-tuning operation	AT ends

\*1. This is the maximum change in PV when the input filter is 0%. In the case of a higher input filter, the maximum change in PV can be higher.

\*2. Bit 5 of the error code is set when the calculated PID parameters are out of range. Bit 5 is not set when AT is stopped by the user.

#### Setup of the PID Function Block directly from the α2 Series Controller

- 1) Allocate the input PV pin to be used for the function block.
- 2) Press the “OK” key with the cursor in the function block. The function block edit screen is displayed as shown.



- 3) Press the “OK” button to setup the parameters for the PID function block.

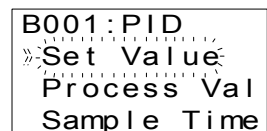

- 4 ) Highlight SetValue and select it using the “OK” button. Choose from DirectSet, Analog In, or FB Value for the Set Value of the PID function block.

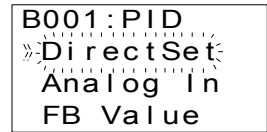

- 5 ) After selecting the appropriate constant, analog input or word output, press the “OK” button to return to the function block settings menu.

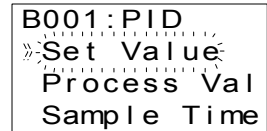

- 6 ) Highlight and select Process Val using the “OK” button. Choose from DirectSet, Analog In or FB Value for the Process Value of the PID function block.

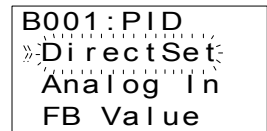

- 7 ) After selecting the appropriate constant, analog input or word output, press the “OK” button to return to the function block settings menu.

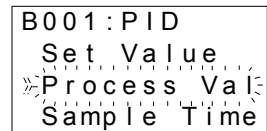

- 8 ) Highlight Sample Time using the up and down keys.

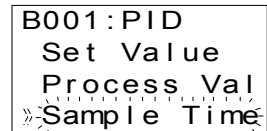

- 9 ) Press the “OK” button and enter a value using the “+” and “-” buttons.

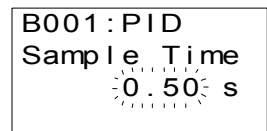

- 10 ) Press the “OK” button to return to the function block settings menu. Highlight  $K_P$  using the “▲ and ▼” button.

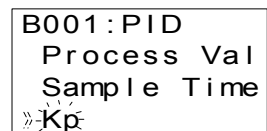

- 11 ) Press the “OK” button and enter a  $K_P$  value using the “+” and “-” buttons.

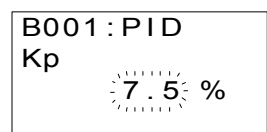

12 )Press the “OK” button to return to the function block settings menu. Highlight  $T_i$  using the “▲ and ▼” button.

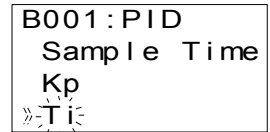

13 )Press the “OK” button and enter a  $T_i$  value using the “+” and “-” buttons.

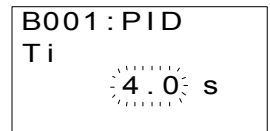

14 )Press the “OK” button to return to the function block settings menu. Highlight  $T_d$  using the “▲ and ▼” button.

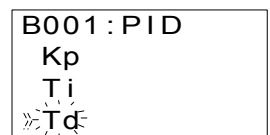

15 )Press the “OK” button and enter a  $T_d$  value using the “+” and “-” buttons.

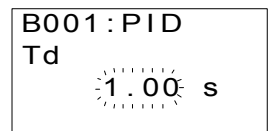

16 )Press the “OK” button to return to the function block settings menu. Highlight  $K_d$  using the “▲ and ▼” button.

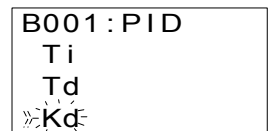

17 )Press the “OK” button and enter a  $K_d$  value using the “+” and “-” buttons.

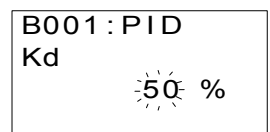

18 )Press the “OK” button to return to the function block settings menu. Highlight NoiseFilter using the “▲ and ▼” button.

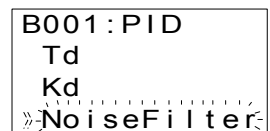

19 )Press the “OK” button and enter a NoiseFilter value using the “+” and “-” buttons.

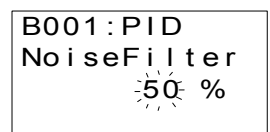

20 )Press the “OK” button to return to the function block settings menu. Highlight Upper Limit using the “▲ and ▼” button.

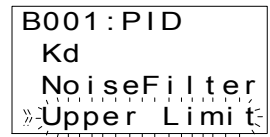

21 )Press the “OK” button and enter an Upper Limit value using the “+” and “-” buttons.

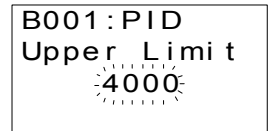

22 )Press the “OK” button to return to the function block settings menu. Highlight Lower Limit using the “▲ and ▼” button.

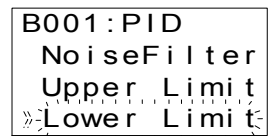

23 )Press the “OK” button and enter a Lower Limit value using the “+” and “-” buttons.

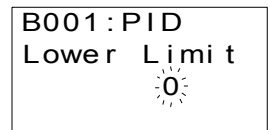

24 )Press the “OK” button to return to the function block settings menu. Highlight AT Bias using the “▲ and ▼” button.

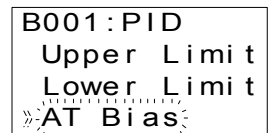

25 )Press the “OK” button and enter an AT Bias value using the “+” and “-” buttons. Press the “OK” button.

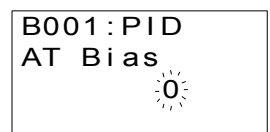

26 )Highlight Response from the function block settings menu.

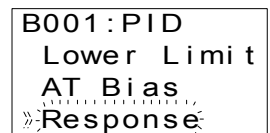

27 )Press the “OK” button to select Response. Select the type of PID response that will be used. The choices are Normal, Fast and Slow.

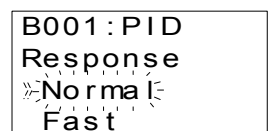

28 )Press the “OK” button to return to the function block settings menu. Highlight Direction to choose the direction of operation for the PID function block.

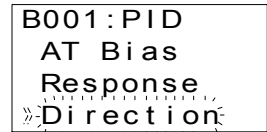

29 )Press the “OK” button to choose from Forward or Reverse operation.

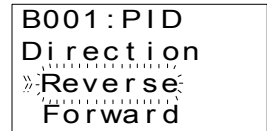

30 )Highlight AT Result to select the type of control to be employed after auto-tuning finishes. .

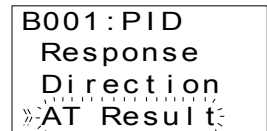

31 )Press the “OK” button and highlight the desired control type from the list: P-, PI- or PID-control.

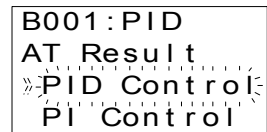

32 )Press “OK” to return to the function block settings menu.

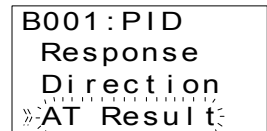

33 )Press “ESC” twice to return to the FBd.

### 6.23 Retentive Alternate Block

This block is equivalent to the Alternate Function block described in section 6.4 but includes a the retention function. When the retention function is ON, the Retentive Alternation (RAL) output will act as a latched output and remember the ON/OFF settings in the case of a power failure. Every time the input pin receives a signal the ALT Output changes its ON/OFF status. The Output alternates turning ON and OFF.

A Clear input signal over-rides the input signal and turns the Output OFF.

**Table 6.31: Retentive Alternate Function Block**

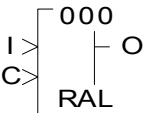
Function	Set Item	Description
	I	Input pin for retentive alternate function block
	C	Clear input pin resets the state of the output regardless of the input given
	FB	Retentive alternation of the output status
	Output	The output is affected in the following operation: 1) Reverse the ON/OFF state of the output whenever the input signal's ON/OFF operation to the input pin is turned ON (ON to OFF or OFF to ON) 2) The clear selection resets the output regardless of the input given. 3) Remember Output Signal after a Power Cut

Retentive Alternation time chart

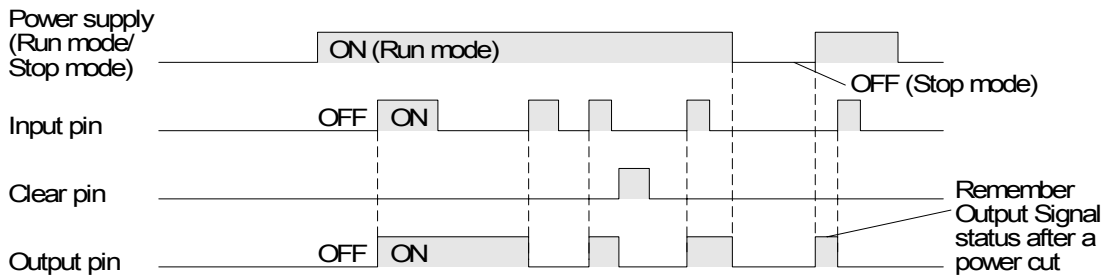

### 6.24 Addition Block

The function block is used to summate inputs A and B hence produce the resultant Y.

**Table 6.32: Addition Function Block**

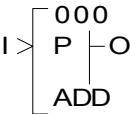
Function	Set Item	Description
	I	Input pin for addition function block
	FB	This function block operates the expression $Y=A+B$ . The set value of A and B can be selected from the following three sources: 1) DirectSet (Constant value) : setting range -32768 to +32767 with an initial value 0 2) Analog In (Analog Input) : setting range A01 to A08 with an initial input A01 3) FB Value: output value from a function block
	Output	1) Word Output When the input pin is ON, $Y=A+B$ is executed and the word output will be given the result. When the input pin is OFF the expression is not executed and the Y value will retain the last result. 2) Bit Output - Operation result $Y < -32768$ : Output pin turned ON and the operation result Y will be set to -32768 - Operation result $Y > 32767$ : Output pin turned ON and the operation result Y will be set to 32767

Setup of the Addition Function Block directly from the α2 Series Controller

- 1) Allocate the input pin to be used for the function block.
- 2) Press the “OK” key with the cursor in the function block. The function block edit screen is displayed as shown.

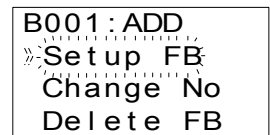

- 3) Press the “OK” Key and enter the function block settings using the “▲ and ▼” keys. The Addition operation  $Y=A+B$  must be specified.

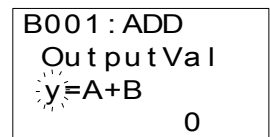

- 4) Using the “◀ and ▶” keys highlight Constant A and press the “OK” key to enter either a Directset, Analog In or FB Value.

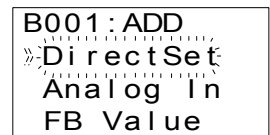

- 5) Repeat step 4 for Constant B and return to the FBd using the “ESC” key.



### 6.25 Subtraction Block

The function block is used to subtract inputs B from A hence produce the resultant Y.

**Table 6.33: Subtraction Function Block**

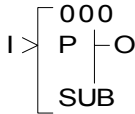
Function	Set Item	Description
	I	Input pin for subtraction function block
	FB	This function block operates the expression $Y=A-B$ . The set value of A and B can be selected from the following three sources: 1) DirectSet (Constant value) : setting range -32768 to +32767 with an initial value 0 2) Analog In (Analog Input) : setting range A01 to A08 with an initial input A01 3) FB Value: output value from a function block
	Output	1) Word Output When the input pin is ON, $Y=A-B$ is executed and the word output will be given the result. When the input pin is OFF the expression is not executed and the Y value will retain the last result. 2) Bit Output - Operation result $Y<-32768$ : Output pin turned ON and the operation result Y will be set to -32768 - Operation result $Y>32767$ : Output pin turned ON and the operation result Y will be set to 32767

Setup of the Subtraction Function Block directly from the α2 Series Controller

- 1) Allocate the input pin to be used for the function block.
- 2) Press the “OK” key with the cursor in the function block. The function block edit screen is displayed as shown.

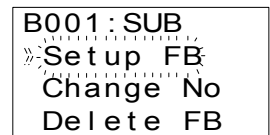

- 3) Press the “OK” Key and enter the function block settings using the “▲ and ▼” keys. The Subtraction operation  $y=A-B$  must be specified.

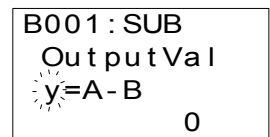

- 4) Using the “◀ and ▶” keys highlight Constant A and press the “OK” key to enter either a Directset, Analog In or FB Value.

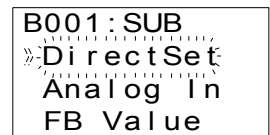

- 5) Repeat step 4 for Constant B and return to the FBd using the “ESC” key.

## 6.26 Multiplication Block

The function block is used to multiply inputs A and B hence produce the resultant Y.

**Table 6.34: Multiplication Function Block**

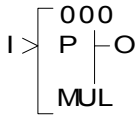
Function	Set Item	Description
	I	Input pin for multiplication function block
	FB	This function block operates the expression $Y=A*B$ . The set value of A and B can be selected from the following three sources: 1) DirectSet (Constant value) : setting range -32768 to +32767 with an initial value 0 2) Analog In (Analog Input) : setting range A01 to A08 with an initial input A01 3) FB Value: output value from a function block
	Output	1) Word Output When the input pin is ON, $Y=A*B$ is executed and the word output will be given the result. When the input pin is OFF the expression is not executed and the Y value will retain the last result. 2) Bit Output - Operation result $Y < -32768$ : Output pin turned ON and the operation result Y will be set to -32768 - Operation result $Y > 32767$ : Output pin turned ON and the operation result Y will be set to 32767

Setup of the Multiplication Function Block directly from the α2 Series Controller

- 1) Allocate the input pin to be used for the function block.
- 2) Press the “OK” key with the cursor in the function block. The function block edit screen is displayed as shown.

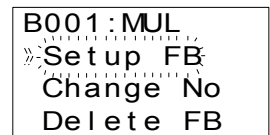

- 3) Press the “OK” Key and enter the function block settings using the “▲ and ▼” keys. The Multiplication operation  $y=A*B$  must be specified.

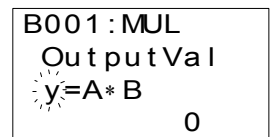

- 4) Using the “◀ and ▶” keys highlight Constant A and press the “OK” key to enter either a Directset, Analog In or FB Value.

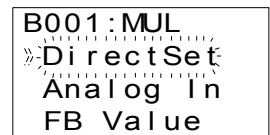

- 5) Repeat step 4 for Constant B and return to the FBd using the “ESC” key.

### 6.27 Division Block

The function block is used to divide inputs A and B hence produce the quotient Q and remainder R.

**Table 6.35: Division Function Block**

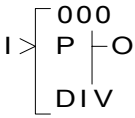
Function	Set Item	Description
	I	Input pin for division function block
	FB	This function block operates the expression $Q=A/B, R=A\%B$ The set value of A and B can be selected from the following three sources: 1) DirectSet (Constant value): setting range -32768 to +32767 with an initial value 0 2) Analog In (Analog Input) : setting range A01 to A08 with an initial input A01 3) FB Value: output value from a function block
	Output	1) Word Output When the input pin is ON, $Q=A/B, R=A\%B$ and the word output will be given the result. When the input pin is OFF the expression is not executed and the Q and R values will retain the last result. 2) Bit Output - Input value (B) = 0: Output pin is turned ON and the quotient Q and R will reset to 0. - Quotient (Q) > 32767: Output pin is turned ON and the quotient Q will be set to 32767.

Setup of the Division Function Block directly from the α2 Series Controller

- 1) Allocate the input pin to be used for the function block.
- 2) Press the “OK” key with the cursor in the function block. The function block edit screen is displayed as shown.

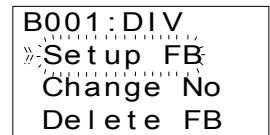

- 3) Press the “OK” Key and enter the function block settings using the “▲ and ▼” keys. The Division operation  $Q=A/B$  must be specified.

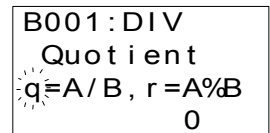

- 4) Using the “◀ and ▶” keys highlight Constant A and press the “OK” key to enter either a Directset, Analog In or FB Value.

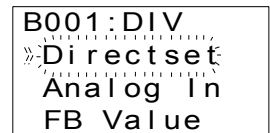

- 5) Repeat step 4 for Constant B and return to the FBd using the “ESC” key.

### 6.28 Calculation Block

The function block creates an expression using up to four input word data (A, B, C and D) using five operators (+, -, \*, /, %) and outputs the calculation result to Y. A maximum of 64 terms can be included in the calculation expression. Nesting using parenthesis is available up to 6 times.

**Table 6.36: Calculation Function Block**

Function	Set Item	Description
	I	Input pin for multiplication function block
	FB	<p>This function block creates an expression using up to 4 input words (A, B, C, D), 5 operators (+, -, *, /, %) and outputs the calculation result to Y. A maximum of 64 terms can be included in the calculation expression. Nesting using parenthesis is available up to a maximum of 6 levels.</p> <p>Input values A, B, C, and D set the following values:</p> <ol style="list-style-type: none"> <li>1) DirectSet (Constant value): setting range -32768 to +32767 with an initial value 0</li> <li>2) Analog In (Analog Input) : setting range A01 to A08 with an initial input A01</li> <li>3) FB Value: output value from a function block</li> </ol>
	Output	<p>1) Word Output (Y) When the input pin is ON, the word output will be given the calculation result. When the input pin is OFF the expression is not executed and the word output values will retain the last result.</p> <p>2) Bit Output</p> <ul style="list-style-type: none"> <li>- If there is an error in the formula, output pin is ON.</li> <li>- If the operation process value exceeds the range of -32768 to 32767, output pin is ON.</li> </ul>

**Table 6.37: Calculation Function Block terms**

Term	Description
Y	Operation result
A, B, C and D	Input value
+	Calculation sign for addition
-	Calculation sign for subtraction
*	Calculation sign for multiplication
/	Calculation sign to request the Quotient
%	Calculation sign to request the remainder

Setup of the Calculation Function Block directly from the α2 Series Controller

- 1 ) Allocate the input pin to be used for the function block.
- 2 ) Press the “OK” key with the cursor in the function block.  
The function block edit screen is displayed as shown.

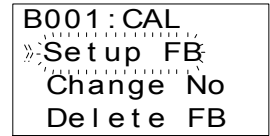

- 3 ) Press the “OK” Key and enter the function block settings using the “▲ and ▼” keys. The Calculate operation [y= ] must be specified.

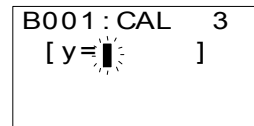

- 4 ) While the cursor is flashing, use the “▲ and ▼” keys to select the appropriate character or constant for your intended calculation. The following items are offered: A, B, C, D, +, -, \*, /, %, ( or )

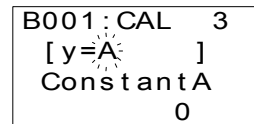

- 5 ) DirectSet values, Analog In or FB Value can all be entered for each constant.

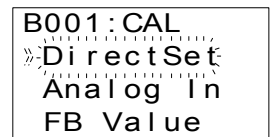

- 6 ) Return to the FBd using the “ESC” key.

### 6.29 Shift Block

The function block uses a shift control signal (T) to map the current ON/OFF state of the input pin (I) to the output pin. The operation of this FB is similar to the behavior of a D flip-flop. The function block can set or reset the status of the output with the input pins, Set (S) and Reset (R). The Shift Function block retains the state of the output pin after power has been reset.

**Table 6.38: Shift Function Block**

Function	Set Item	Description
	I	Input pin for bit to be shifted
	T	Shift control pin
	S	Set pin to manually set the output
	R	Reset pin to manually reset the output
	FB	This FB transfers the ON/OFF state of the bit input pin (I) to the output at the rising edge of the shift control pin (T). There are no function block settings for this block.
	Output	<ol style="list-style-type: none"> <li>1) The output will turn ON or OFF at the rising edge of the shift control pin (T) depending on the ON/OFF state of the bit input pin (I).</li> <li>2) The output will go ON if Set (S) pin is turned ON.</li> <li>3) The output will go OFF if the Reset (R) pin is turned ON.</li> <li>4) If both the Set and Reset signals are turned ON simultaneously, the Set operation will take precedence over the Reset operation. The Set operation has high priority (i.e. Set &gt; Reset &gt; Shift).</li> </ol> <p>Note: The output will not be affected if a change in the input pin status took place between two rising edges. See the timing diagram below.</p>

#### 1) Shift Operation Timing Diagram

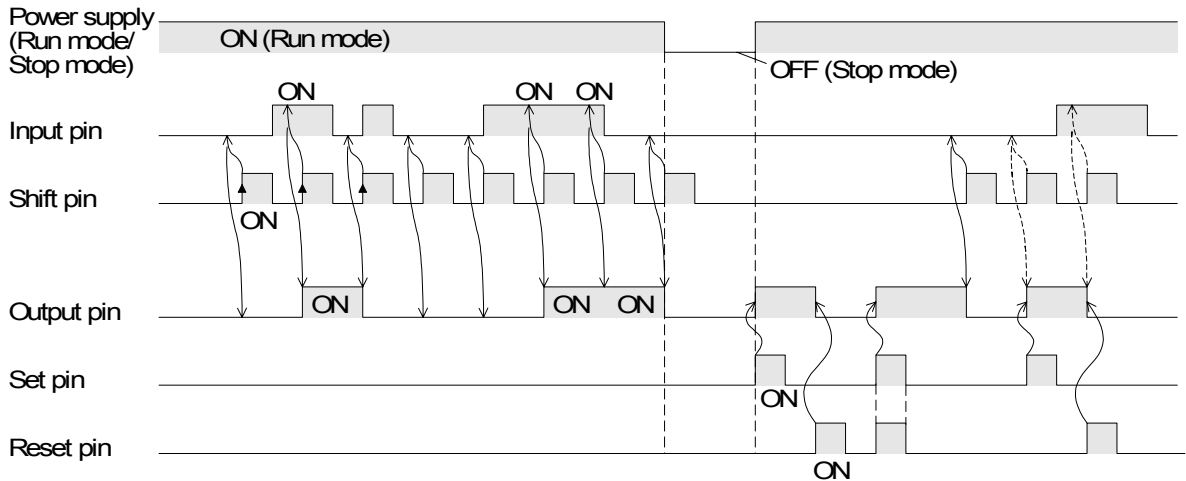

2 ) 3-Bit Shift Operation

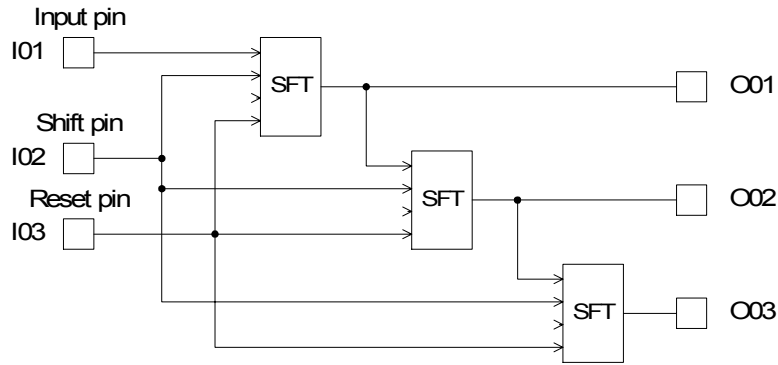

3-Bit Shift Operation Timing Diagram

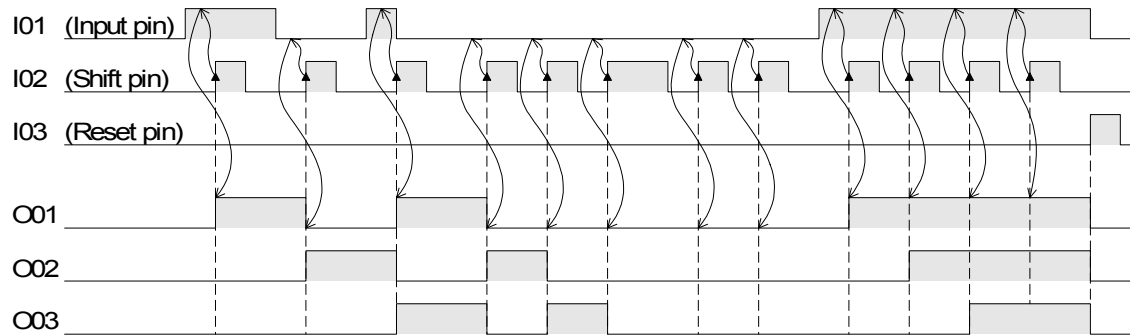

3 ) 3-Bit Shift Operation 2

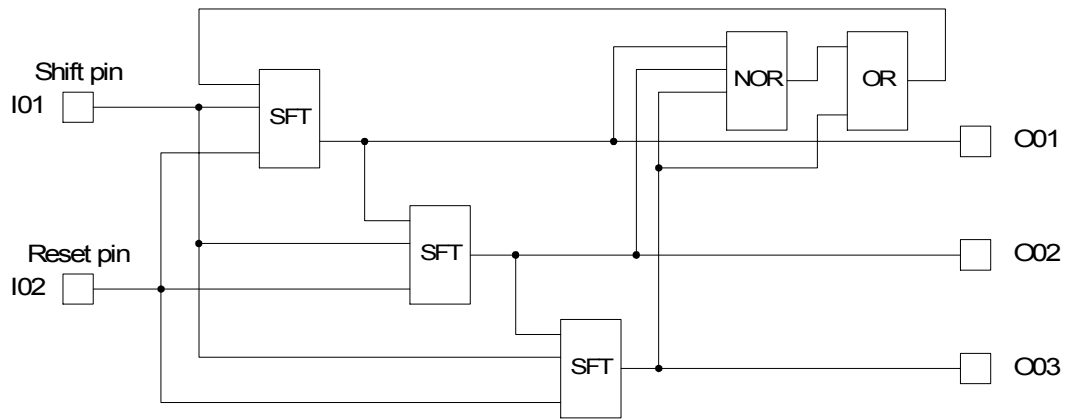

3-Bit Shift Operation 2 Timing Diagram

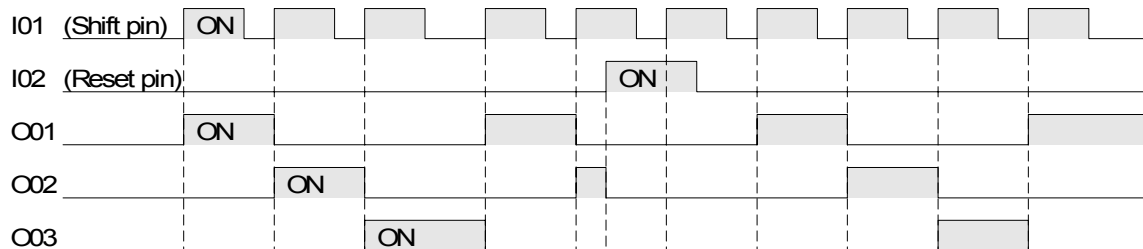

### 6.30 GSM/SMS Block

The GSM/SMS function block, when used with a GSM modem, provides SMS (Short Message Service) communication between the α2 Series Controller and a mobile device or computer. Pin code. Gateway and Mobile access information from an SMS Service Provider is necessary to use the SMS function properly. The GSM/SMS function block can also be used to provide remote access from a computer running VLS software to the remote α2 Series Controller. Using the remote access option disables SMS capabilities.

**Table 6.39: GMS Function Block**

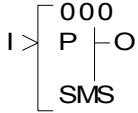
Function	Set Item	Description
	I	Bit input pin for GSM/SMS function block operation
	FB	<p><b>Refer to the Communication Manual for detailed explanations concerning the GSM functionality of the α2 Series controllers.</b></p> <ol style="list-style-type: none"> <li>1) Detects the ON/OFF status of an input and subsequently sends the SMS (Short Message Service) to the predefined user destination.</li> <li>2) The SMS message will continue to send regardless of the input switching OFF.</li> <li>3) The input will be ignored if it turns on during:                             <ol style="list-style-type: none"> <li>a) an SMS transmission</li> <li>b) the waiting period.</li> </ol> </li> <li>4) Communication failure (e.g. busy line) will tell the SMS function block to retry three times in a period of two minutes.</li> <li>5) If the message was not sent after the third retry, the output status will switch to ON and an error message will be generated through the word pin of the function block.</li> <li>6) The user may experience incorrect validity period timings. Please check with your Service Provider.</li> <li>7) If both the Mobile (SMSC1) and Gateway (SMSC2) numbers are entered, the α2 controller will automatically choose the correct path number for the SMS in conjunction with the destination chosen. The destination being either to a mobile phone (SMSC1) or an email address (SMSC2).</li> </ol>
	Output	<ol style="list-style-type: none"> <li>1) The output status will set ON when the GSM/SMS block:                             <ol style="list-style-type: none"> <li>a) succeeds in sending an SMS message</li> <li>b) fails at sending an SMS message after three retries.</li> </ol> </li> <li>2) If more than one SMS function block exists in the program, an FIFO (First In First Out) sequence is performed.</li> <li>3) The following items are available for other function blocks:                             <ol style="list-style-type: none"> <li>a) SMS message sent/SMS failed to be sent after 3 attempts</li> <li>b) Current Status (See 6.29.3 - Word Output)</li> </ol> </li> </ol>



**Note:**

Transmission of UCS2 encoded short messages to an email account is not necessarily supported for a SMS Gateway. In the event no support by the SMS Gateway, UCS2 encoded short messages cannot be sent to an email account and a fax machine. Please contact the used GSM network provider.



1 ) SMS Operation Timing Diagram

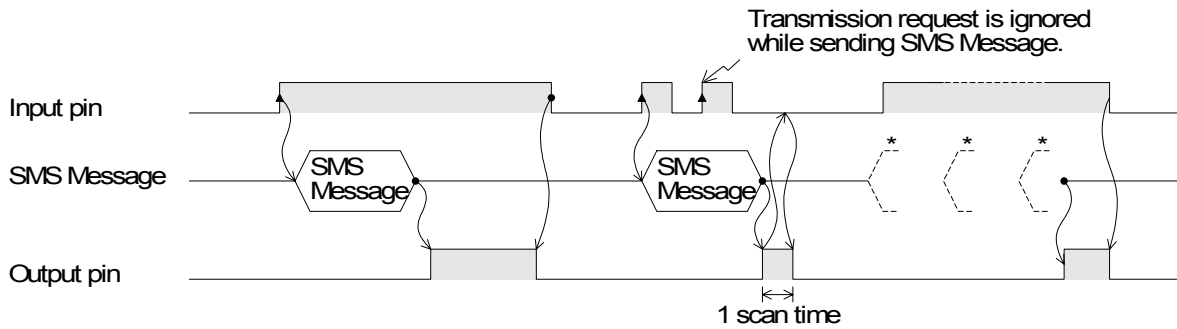

\*Communication failure will tell the GSM/SMS FB to retry three times in two minutes.

2 ) Sample VLS Program: SMS - Retry Sending Data

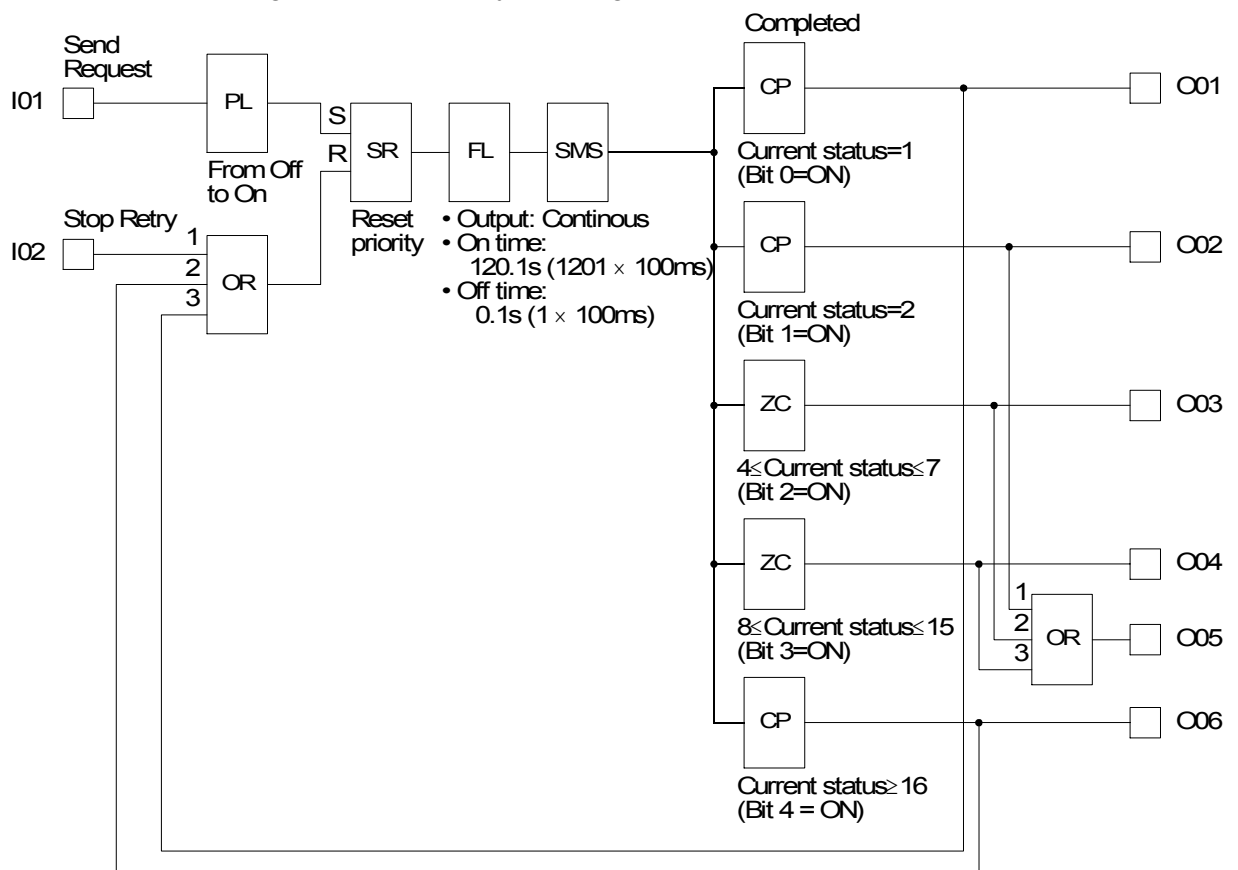

The GSM Function block will send the SMS packet when the input pin is activated. To input or edit the GSM/SMS parameters, double click on the GSM/SMS icon to open the Short Message Service dialog box in AL-PCS/WIN-E. When two or more Function Blocks are trying to send a message at the same time, the one to connect first will send its SMS message or attempt to send its message three times. The other GSM/SMS FB(s) will be placed in "Wait" status. All the FBs will send their messages in turn.

### 6.30.1 Input Signal

The α2 controller will send the SMS message to the chosen destination when the input pin is activated. The operation will continue until the message is sent or the retries have been completed even if the Input pin is turned OFF during the process. When the Input turns ON and then resets during the send operation or when the FB is in "Wait" status, all further Input ON signals are ignored until the Output pin has been reset.

### 6.30.2 Output Signal

The Output signal comes ON when the SMS message has been successfully sent or the final retry has taken place. If the Input signal that began the operation remains ON, the Output will remain ON. If the Input signal turns OFF during the send operation, the Output signal will remain ON for one program scan after the send operation is complete and then turn OFF. After the initial Input signal has turned OFF, all other input signals are ignored until the Output has been reset.

### 6.30.3 Word Output

Check the status of the transmission by checking the Output Word data when connected to a Display FB.

**Table 6.40: Output Word Value**

Bit	Description
b0	Transmission is Complete
b1	Transmission or retry in Progress
b2	Transmission is in "Wait" status *1
b3	Transmission Failed
b4	Transmission did not occur because of SMS Parameter Error
b5 - b15	Reserved, will always be 0

\*1 The most common "Wait" status conditions are when 1) another GSM FB is transmitting a message, 2) the GSM modem has not been initialized, or 3) Remote Access by the VLS software is taking place. After the Output is turned OFF, the Word output status will also be reset to 0.



Note: The Word Value will be displayed in hexadecimal format but the Table is given in binary form. If b2 is On, for example, the Output Word will display a value of 00x4 (hex). It is possible that more than one bit will be ON simultaneously.

### 6.30.4 Short Message Service (SMS)

The GSM/SMS Function Block sends the SMS message to the address chosen in the Short Message Service dialog box. Each GSM/SMS FB can only send a message to one address.

### 6.30.5 Comment/Signal Number

Input a comment to label the function block. The comment will be shown onscreen only if the “Display Comment” box is checked. Similarly, the Function Block number will only be shown onscreen if the “Display Signal Number” box is checked.

**GSM SMS (Short Message Service)**

Comment:

Display Comment

Display Signal Number

Setting

SMS Service Center

For Mobile:

For E-mail:

Valid Period:

Destination

Use	Name	Phone Number
<input checked="" type="radio"/>	Telekom	3465
<input type="radio"/>	Justin	345456788967
<input type="radio"/>	Ken	73639887569

E-mail:

OK Cancel Help

### 6.30.6 Setting

This box will open the SMS Setting Dialog box. The information for the destination locations is entered in the SMS Setting dialog box but the final destination is chosen in the Destination area described below.

### 6.30.7 Destination

The Destination telephone numbers and e-mail Gateway parameters are shown. Choose the desired destination phone number or Gateway setting for the specific GSM/SMS Function Block. The choice of a mobile phone number will complete the selection process. If the Gateway setting is chosen, the destination e-mail address must be entered in the “E-mail” box. Every GSM/SMS FB can have a different e-mail address. Press the “OK” button to accept the settings.

### 6.30.8 SMS Setting Dialog Box

The SMS Setting Dialog box is accessed from the Short Message Service (SMS) dialog box in any GSM/SMS Function Block by clicking the Setting button on the example window above. The SMS Setting dialog box is not specific to a single Function Block. The parameters entered here apply to all Function Blocks. The parameter settings are the data required by the SMS service provider to set up the final destination points. Messages can be sent to 1) three telephone numbers or 2) two telephone numbers and one Gateway number. The same Gateway can be used for multiple e-mail addresses so that the only limit on e-mails is the α2 controller memory. Each GSM/SMS Function Block can service a single e-mail address. E-mail access codes from the SMS service provider are required to send SMS e-mails.

### 6.30.9 SMS Service Center

Input the number given by the SMS Service Provider for Mobile and Gateway access. It is possible that the same number will be used for both applications. Please verify with the Service Provider whether the International code is needed at the beginning of the phone number.

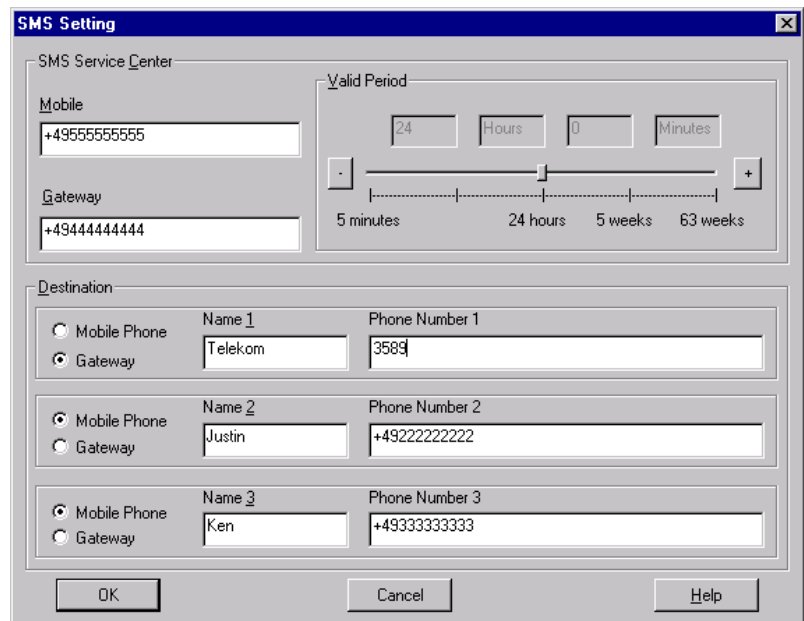

### 6.30.10 Valid Period

This is the requested period for the message to exist on the Service Provider’s Server. This parameter is ultimately under the control of the Service Provider who might change the time period according to their company policy. The time can be set from a minimum of five minutes to a maximum of 63 weeks.

### 6.30.11 Destination

Click the Mobile Phone option to input data for a mobile phone. Use the “Name #” as an optional memo area. Enter the Destination phone number in the “Phone Number #” box. Please verify with the Service Provider whether the International code is needed at the beginning of the phone number. Click the Gateway option to input data in order to send an e-mail. Use the “Name #” as an optional memo area. Enter the e-mail access code from the Service Provider in the “Phone Number #” box.

***These destination numbers will be valid for all SMS function blocks. E-mails can be sent to as many addresses as the α2 memory allows. SMS messages can be sent to a maximum of three telephone numbers.***

### 6.30.12 Error Messages

The Status of the GSM communication can be checked in the right hand side of the Diagnosis of Controller (Controller ⇨ Diagnosis of Controller) dialog box. This dialog box cannot be accessed while the controller is running.

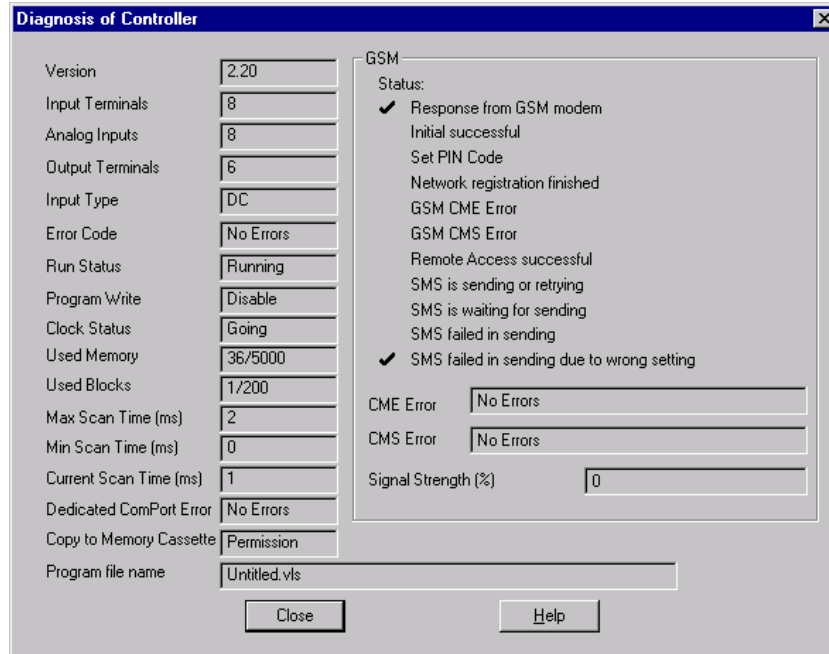

The CME and CMS Error boxes give information to the functioning of Mobile Equipment (ME), please refer to the GSM modem manual for more details.

#### Modem Settings/Front Panel Keys

The settings required to send SMS packets via a GSM modem or to set up the α2 controller for remote access can be accomplished with the front panel keys. It is possible to perform remote operations with a standard modem but it is not possible to send SMS packets.

The numerous parameters and options for using the GSM modem can be set using the front panel keys. However, the procedure is much easier to perform with the AL-PCS/WIN-E software than with the front panel display and buttons.

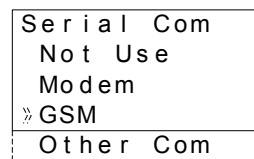

To begin the process from the Top Menu, scroll down to “Others/Serial Com/GSM” and view the options shown at right.

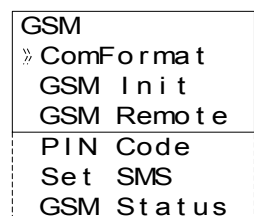

#### ComFormat (Communication Format)

Upon entering the GSM option, the ComFormat dialog will be the first option. The ComFormat allows the user to set the communication settings for Data Length, Parity, Stop Bit, and Baudrate.

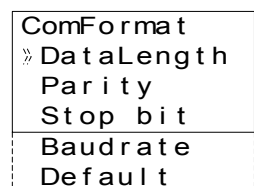

Scroll to the setting to be adjusted.

Data Length

Select a Data length of 7 or 8 bits.

```

DataLength
» 8 bits
  7 bits

```

Parity

Select from three options for Parity - None, Odd or Even.

```

Parity
» None
  Odd
  Even

```

Stop Bits

Choose the number of stop bits - 1 bit or 2 bits.

```

Stop bit
» 1bit
  2bits

```

Baud Rate

Select the baud rate - 9600 or 19200 bps.

```

Baudrate
» 9600 bps
  19200 bps

```

Default

The controller can be returned to the default communication settings - DataLength = 8 bits; Parity = None; Stop Bits = 1; and Baud Rate = 9600 bps - by pressing the "OK" when the pointer is on the Default option.

GSM Init Command (GSM Initialization Command)

The GSM modem must have an initialization command string. After choosing the "GSM Init" option, the Command and Delay Time settings will appear.

```

GSM Init
» Command
  DelayTime

```

Command Setting

Choose "Command" to enter the AT command. Details for the AT command should be included in the literature for the modem. Enter the string by choosing the correct characters with the "▲" and "▼" arrows. When a desired letter is shown onscreen, move to the right by pressing the "▶" key. The character will remain in the previous cursor space. Do not press the "OK" key until the command has been entered in its entirety. Move to the left for editing purposes with the "◀" key.

```

GSM Init01
  Command
  [ A      ]
  <=>?@ABCDE

```

Delay Time

The Delay Time Setting will delay the transmission of the initialization command while the modem completes its power up. Use the "+" key to increment the value and the "-" to decrement the value within the range of 0 - 10 seconds. Enter the value by pressing the "OK" key.

```

GSM Init
  DelayTime
    0s

```

GSM Remote Command

Remote access from a computer running the VLS software is allowed when "Permit" is chosen.

SMS packets cannot be sent under the "Permit" setting but can be sent when "Forbid" is used.

```

GSM Remote
» Forbid
  Permi t

```

Enter the PIN Code

It is necessary to enter a PIN code received from the Service Provider when the α2 controller is used to send SMS packets. Use the “+” and “-” keys to choose the digits of the code and the “▶” and “◀” keys to move to adjoining digits. SIM PIN setup [“\*\*\*\*”] or [\*\*\*\*] can be activated and deactivated by the cursor △ and cursor ▽ soft key. (Version 2.20 or later) All the numbers must be set to an integer value or a PIN Code Error will be received. Press the “OK” or “ESC” keys to return to the PIN Code entry display. Finish entering all integer values into all four digits and press the “OK” key to enter the code.

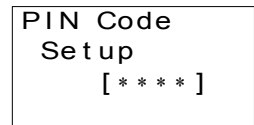

Cancel the PIN Code

To Cancel an existing PIN code, enter the PIN Code option and confirm with the “OK” key the intent to Cancel the code. The PIN Code does not have to be entered in order to Cancel the code. Use the “ESC” key to return to the GSM menu.

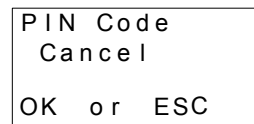

Set SMS (Short Message Service) Parameters

The SMS menu is used to set the telephone numbers for the Service Provider, the destination numbers for cellular phones, the access code for e-mail messages, and the Validity Period of the messages.

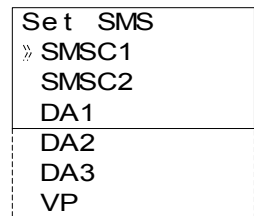

The SMS Service Provider Mobile Access Number (SMSC1)

The SMSC1 is the number used to access the Service Provider section for mobile phones. Choose the digits and symbols using the “▲” and “▼” keys. After the digit is set, move to the left or right with the “▶” and “◀” keys. Do not press the “OK” key until the command has been entered in its entirety.

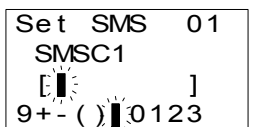

The SMS Service Provider Gateway Access Number (SMSC2)

The SMSC2 is the number used to access the E-mail gateway telephone number of the SMS Service Provider. Choose the digits and symbols using the “▲” and “▼” keys. After the digit is set, move to the left or right with the “▶” and “◀” keys. Do not press the “OK” key until the command has been entered in its entirety. This number may be the same as used in SMSC1.

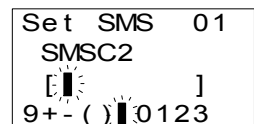

Destination Address (DA1, DA2, DA3)

Enter the destination mobile telephone number or the Service Provider e-mail gateway code on this screen. Choose the digits and symbols using the “▲” and “▼” keys. After the digit is set, move to the left or right with the “▶” and “◀” keys. Do not press the “OK” key until the command has been entered in its entirety.

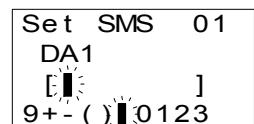

Three destination mobile telephone numbers can be entered, one in each DA address. Alternately, two mobile phone numbers and one e-mail gateway access code can be entered. Only one e-mail access code needs to be entered and then multiple e-mail addresses can be input, one each per GSM/SMS Function Block.

**Validity Period**

The Validity Period is a request to the SMS Service Provider to keep the message on their Server for a length of time. Each Service Provider may have their own policies on the allowable time messages can be kept. Please check with your local Service Provider to obtain these details. Use the “+” and “-” keys to change the value within the range of 5 minutes to 63 weeks.

```
Set SMS
VP
 24.0hrs
```

**GSM Status**

Check the status of the GSM communication in the following categories.

```
GSM Status
» Status
CME Error
CMS Error
SigStreng
```

Check the Status of the GSM modem settings and SMS message transmissions through the table below.

```
GSM Status
Status
0000H
```

**Table 6.41: GSM Modem Status**

Bit	Status	On (1)	Off (0)
b0	Error in Connecting to GSM Modem.	Yes	No
b1	GSM Initialization Command Normal.	Yes	No
b2	PIN Code is Setup in the Controller.	Yes	No
b3	Network Registration.	Registered	Not Registered
b4	GSM CME Error.	Yes	No
b5	GSM CSM Error.	Yes	No
b6	Remote Access In Progress. *1	Yes	No
b7	SMR Receive Time out	Yes	No
b8-11	Reserved	Reserved = 0	
b12	SMS Message Contents.	Message	No Message
b13	SMS Transmission Standby State. Transmitting/Off (1/0)	Transmitting	Off
b14	SMS Transmission Failed 3 Times. Yes/No (1/0)	Yes	No
b15	SMS Transmission not sent due to incorrect SMS Function Block Setting.	Yes	No



Note: \*1This bit is not linked to the Remote Access Setting which only enables remote access. This bit checks if Remote Access is currently in progress.



**CME Error**

This CME Error status gives information to the functioning of Mobile Equipment (ME), please refer to the GSM modem manual for more details.

GSM Status  
CME Error  
- 1

**Table 6.42: Mobile Equipment Error Codes**

Value	Description	Value	Description
-1	No Error	17	SIM PIN2 Required
0	Phone Failure	18	SIM PUK2 Required
1	No Connection to Phone	20	Memory Full
2	Phone-Adaptor Link Reserved	21	Invalid Index
3	Operation Not Allowed	22	Not Found
4	Operation Not Supported	23	Memory Full
5	PH-SIM PIN Required	24	Text String Too Long
10	SIM Failure	25	Invalid Characters in Text String
11	SIM PIN Required	26	Dial String Too Long
12	SIM PUK Required	27	Invalid Characters in Dial String
13	SIM Failure	30	No Network Service
14	SIM Busy	31	Network Timeout
15	SIM Wrong	100	Unknown
16	Incorrect Password	...256	All other values below 256 are reserved.

**CMS Error**

This value gives error information relevant to the Mobile Equipment (ME) or Network, please refer to the GSM modem manual for more details.

GSM Status  
CMS Error  
- 1

**Table 6.43: Mobile Equipment and Network Error Codes**

Value	Description	Value	Description
-1	No Error	315	SIM Wrong
0 - 127	GSM 04.11 Annex E-2 Values	316	SIM PUK Required
128 - 256	GSM 03.40 Subclause 9.2.3.22 values	317	SIM PIN2 Required
300	ME Failure	318	SIM PUK2 Required
301	SMS Service of ME reserved	320	Memory Failure
302	Operation Not Allowed	321	Invalid Memory Index
303	Operation Not Supported	322	Memory Full
304	Invalid PDU Mode Parameter	330	SMSC Address Unknown
305	Invalid Text Mode Parameter	331	No Network Service
310	SIM not Inserted	332	Network Timeout
311	SIM PIN Required	340	No +CNMA acknowledgment expected
312	PH-SIM PIN Required	500	Unknown Error
313	SIM Failure	... 511	Unused Values in the range from 256 to 511 are Reserved.
314	SIM Busy	512 (+)	Manufacturer Specific

Signal Strength (SigStreng)

Check the signal strength of the GSM modem signal. Generally good operation is possible with a signal strength of 10% or more.

```
GSM Status
SigStreng
0%
```

**Table 6.44: Signal Strength Reference Table**

Value %	Receiving Level
0	-113 dBm or less
1	-111 dBm
2 - 30	-109 to -53 dBm
31	-51 dBm or greater
99	Not known

### 6.31 Short Message Receiving Block

A GSM short message (SM) can be sent from a cell phone, a normal phone (with SM functionality) or PC to a GSM modem that is connected to an α2 controller.

α2 controller detects the delivery of SM by the modem and downloads the SM from the modem.

The Short Message Receive FB (SMR FB) searches for the occurrence of a command in the SM. The command is given as text string in the FB parameter. In case the command text is exactly included in the SM, outputs are changed.

A command can consist of max. 32 characters. A received short message can contain up to 160 characters (7 bit) or 70 characters (UFT-16, 16bit).

The difference between SMR and SMRm is allowable maintenance (m) from the TopMenu "Parameter" in the α2 controller for direct programming.

**Table 6.45: SMR Function Block**

Function	Set Item	Description
	E	Bit input pin for the function block operation
	FB	<p><b>Refer to the Communication Manual for detailed explanations concerning the GSM functionality of the α2 Series controllers.</b></p> <p>1) Cmnd String(Cmmand String) In case of Word output mode, only one command text can be setup. In case of Bit output mode, a command text for switching bit output ON and a command text for switching bit output OFF can be setup.</p> <p>2)SM Age(Short Massage age) Setup maximum age of received short message. a) 5 to 720minutes(Unit:5minutes) b) 12.5 to 24Hours(Unit:30minutes) c) 2 to 30day(Unit:1day) d) 5 to 63week(Unit:1week)</p> <p>3) Phone Number Setup short message senders phone number. By setting the phone number in FB parameter, only the Short Message Entity(SME) with the setup phone number can manipulate a SMR FB. Up to 28 characters,including "+ , - * 0 1 2 3 4 5 6 7 8 9 ".</p> <p>4) Password Setup authentication password (4 digit code). The password is common for all SMR FB and stored in Programm Parameter area.</p> <p>5) Acknowledge If this parameter is set and the FB output was manipulated by SM, a acknowledge message is send back to the sender.</p> <p>6) Retention If this flag is set, the SMR FB keeps it's output states at the time of controller power down.</p> <p>7) Upper Limit (Word output mode) In case the transmitted value is bigger than the max. value, max. value becomes active. Max. Value can be [(min.value + 1)...32767].</p> <p>8) Lower Limit (Word output mode) In case the transmitted value is smaller than the min. value, min. value becomes active. Min. Value can be [-32768...(max. value - 1)]</p>

Function	Set Item	Description
	R	Reset pin for the function block
	Output	<p>The SMR FB can be operated in one of two different modes.</p> <p>1) Bit output.</p> <ul style="list-style-type: none"> <li>a) The output is set ON, when the switch ON command is found in the received short message.</li> <li>b) The output is set OFF, when the switch OFF command is found in the short message.</li> <li>c) When R ON, the bit output is reset (OFF). R takes priority over E. When E is OFF the bit output value is hold.</li> </ul> <p>2) Word output.</p> <ul style="list-style-type: none"> <li>a) Word output for transferred values. The output is set to the transmitted value, when the set word output command is found and the value after "=" is valid.</li> <li>b) When R is ON, the word output is set to zero. When E is OFF, the word output is hold. R takes priority over E.</li> </ul>

1) Asterix Character in phone number

The asterix character '\*' can be used to terminate phone number or can be stand-alone. It takes place for any combination of numbers. Using the '\*', one SMR FB can switch for a group of phone numbers.

**Table 6.46: Phone numbers and Outputs**

FB number	Caller's phone number	FB Output
+49 21 02 12 34 56 7	+49 21 02 12 34 56 7	changed
+49 21 02 12 34 56 7	+49 21 02 12 34 56 8	no change
+49 21 02 12 34 56 7	+49 21 02 12 34	no change
+49 21 02 12 34 56 7	+49 21 02 12 34 56 78	no change
+49 21 02 12 34 56 7*	+49 21 02 12 34 56 7	no change
+49 21 02 12 34 56	+49 21 02 12 34 56 7	no change
+49 21 02 12 34 56 *	+49 21 02 12 34 56 7	changed
+49 21 02 12 3*	+49 21 02 12 34 56 7	changed
+49 21 02 12 3*	+49 21 02 12 34 56 8	changed
+49 21 02 12 3*	+49 21 02 12 34 56 78	changed
*	Any phone number	changed
+	Any international phone number	changed

### 3 ) Sample VLS Program: Switch an irrigation system by SM

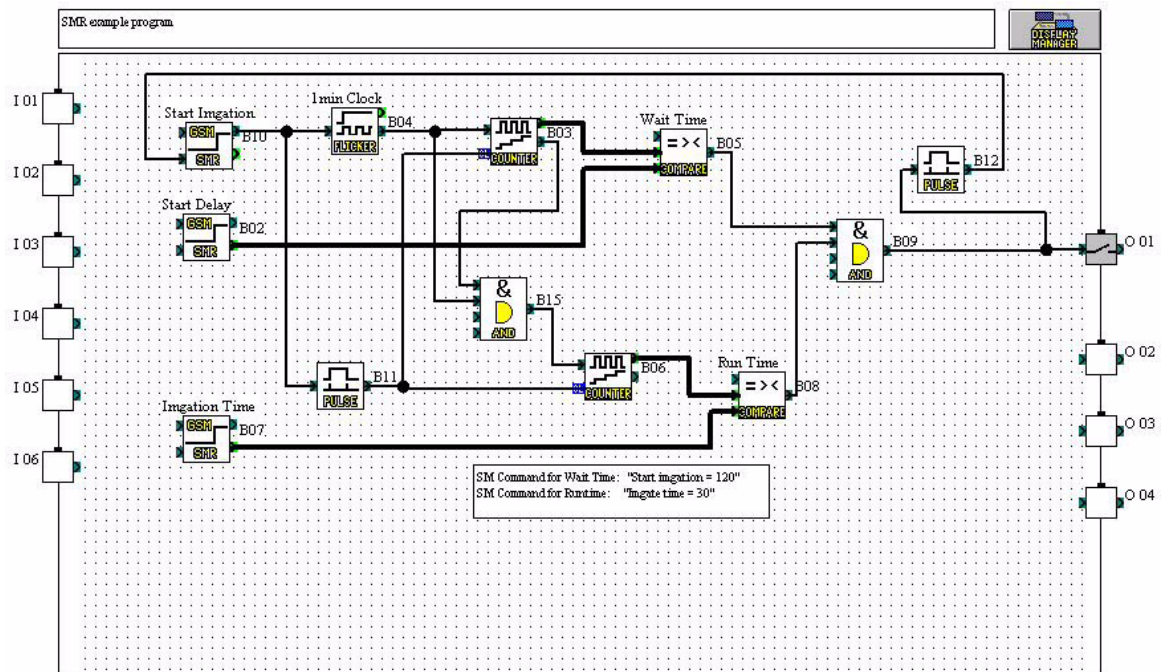

A system for plant irrigation can be switched ON and OFF by short message (B10). The start of irrigation can be delayed. The delay time (in minutes) is transferred by short message. Also the duration of irrigation can be set by short message.

#### 6.31.1 Authentication and Security

Security of manipulation of a user program by SMR FB is given by the following items.

##### 1) Password

A 4 digit numerical code can be set as an additional security level. This code must be located from the first character of the short message, followed by the command delimiter '!'. The code is set in the program parameter, thus valid for all SMR FB in a user program. Setting of a password is optional.

##### 2) Originators Phone Number

The received SM carries the phone number of the sending short message entity (SME). By setting the phone number in FB parameter, only the SME with the setup phone number can manipulate a SMR FB.

##### 3) Command Text

Because the command text can be freely chosen by the customer it is possible to use irregular command words that are only known by one person (like a computer password).

### 6.31.2 SM Commands

The commands included in a short message can be either for switching the bit output of a FB or setting the value output.

#### Bit Output Mode / Word Output Mode

In bit output mode two commands texts can be set, one command text (cmd1) to switch the bit output ON, and an optional command text (cmd2) to switch the bit output OFF.

In word output mode, the command text (cmd3) can be set as FB parameter.

Each command can consist of up to 32 characters.

In the transmitted SM the cmd3 must be followed by the equal character ('=') and a value, e.g. cmd3=100.

The value can be positive and negative ('-') and must be in the range -32768...32767. Space characters or the delimiter character can follow the value.

Mode	Description	FB parameter	SM text
Bit Output	cmd1 for switch output ON cmd2 for switch output OFF	cmd1 cmd2	cmd1 cmd2
Word Output	cmd3	cmd3	cmd3=value

In case the '=' character is not followed by the '-' or the '+' character or a number, the command is invalid. Multi commands can be transmitted in one short message, but not more than 10. All commands have to be separated by the delimiter '.' (dot). Blank characters directly before and after the delimiter are disregarded. A terminating delimiter character is not needed.

In case a short message contains more than one command for one FB, e.g. switch bit output ON and switch bit output OFF, the first command in the short message becomes active. In case of setting the same command text for bit output ON and bit output OFF command and including this command in a short message, the bit output is switched ON.

The following characters can be used to build a command.

**Table 6.47.1: Command Characters (Former than Ver. 3.00)**

Group	Code	Character
1	GSM 7 bit default alphabet plus extension table	<space>! " # \$ % & ' ( ) * + , - / 0 1 2 3 4 5 6 7 8 9 : ; < = > ? @ A B C D E F G H I J K L M N O P Q R S T U V W X Y Z [ \ ] ^ _ a b c d e f g h i j k l m n o p q r s t u v w x y z {   } Ä Å Æ Ç Ñ Ö Ü à á â ã ä å æ è é ê ñ ò ó ü
2	Unicode 16bit	` á â ç ê ë ì í î ï ó ô ú û

**Table 6.47.2: Command Characters (Ver. 3.00 or later)**

Group	Code	Character
1	GSM 7 bit default alphabet plus extension table	<space>! " # \$ % & ' ( ) * + , - / 0 1 2 3 4 5 6 7 8 9 : ; < = > ? @ A B C D E F G H I J K L M N O P Q R S T U V W X Y Z [ \ ] ^ _ a b c d e f g h i j k l m n o p q r s t u v w x y z {   } Ä Å Æ Ç Ñ Ö Ü à á â ã ä å æ è é ê ñ ò ó ü Û Ü Ý Þ ÿ
2	Unicode 16bit	° » À Á Â Ã Ä Å Æ Ç È É Ê Ë Ì Í Î Ï Ñ Ò Ó Ô Õ Ö Ù Ú Û Ü Ý Þ à á â ã ç è é ê ì í î ï ò ó ô õ ö ù ú Б Г Д Е Ж З И Й Л П У Ф Ц Ч Ш Щ Ъ Ы Ь Э Ю Я б в г д е ж з и й к л м н о п с т у ф ц ч ш щ ъ ы ь э ю я

Example of received SM

Example: 1443.Heater ON. Light on .switch xmastree. water = 1233 . CntDown=-23.

This SM contains

- the password 1443
- the command "Heater ON" (FB bit output ON or OFF, depending on FB setup)
- the command "Light on" (FB bit output ON or OFF, depending on FB setup)
- the command "switch xmastree" (FB bit output ON or OFF, depending on FB setup)
- the command "water=1233", which sets the word output of a SMR FB to the value 1233
- the command "CntDown=-23", which sets the word output of a SMR FB to the value -23

6.31.3 Report Short Message Handling

For use of the report short message function, the phone number of the Short Message Service Center must be setup in the program. This can be done by α2 programming or by VLS is the GSM SMS FB setup.

Acknowledge messages

Condition	Transmitted Short Message
α2 in Run Mode, all commands of SM successfully processed	"OK"
α2 in Run Mode, some commands in SM were erroneous.	"Error"
α2 in Run Mode, Sender of SM has no authorization	"No access"
α2 in Run Mode, Password Protection Set, Password invalid or not Set	"No access"

For sending of report short messages, the Short Message Service Center (SMSC) must be setup by using the GSM SMS FB.

Receive Time Out

After sending the short message read command (AT+CMGR) to the modem, α2 waits for 1s for receiving the short message. In case the modem doesn't transmit the received short message to α2 within this time, α2 sets the bit b7 in the GSM status word. This bit can only be checked by α2 GSM Status display. Once set, it can be reset by Cursor Down Key operation.

### 6.31.4 SMR (Short Message Receiving) Setting Dialog Box

The “Short Message Receiving” dialog box is used to set the parameter and SM Commands.

Refer to the Communication Manual for detailed explanations concerning the “Short Message Receiving” dialog box setting of the α2 Series controllers.

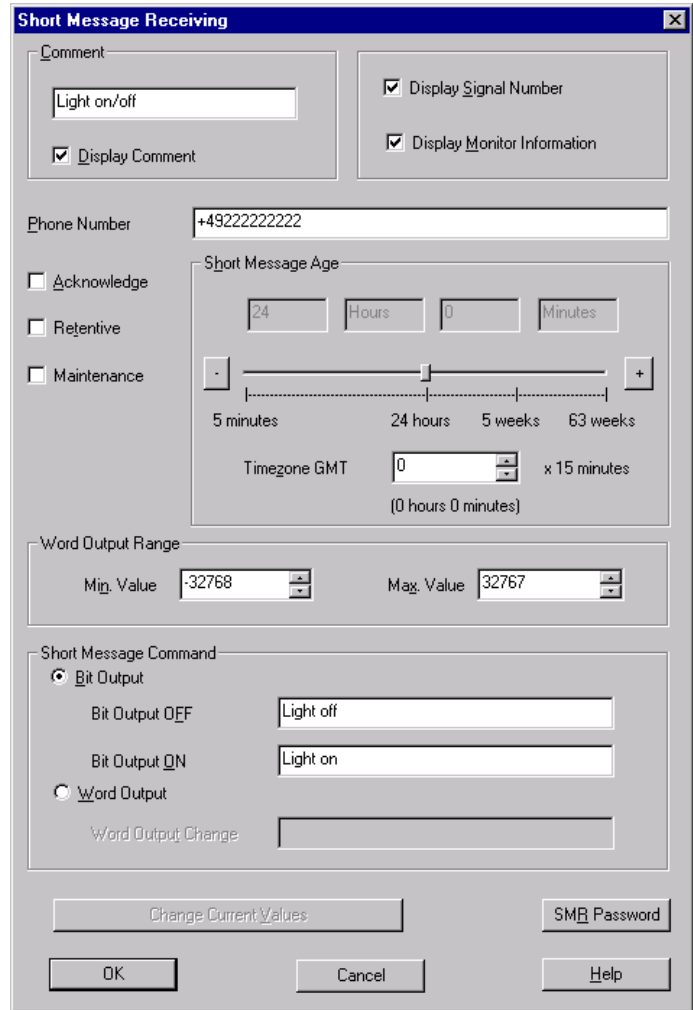



### 6.32 Call Detect Block

In case a GSM modem or an analog modem that supports Calling Line Identification Presentation (CLIP) is called, the number of the calling partner is sent by the modem by the AT notification "+CLIP" attached to the RING notification. α2 extracts the callers's number after a given number of RING notifications.

In case the numbers of digits of both phone numbers and the phone numbers itself are equal, the CD FB output is switched on.

The difference between CD and CDm is allowable maintenance (m) from the TopMenu "Parameter" in the α2 controller for direct programming.

**Table 6.48: CD Function Block**

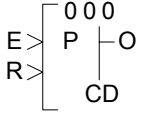
Function	Set Item	Description
	E	Bit input pin for the function block operation
	FB	1) Retention If this flag is set, the CD FB keeps it's output state at the time of controller power down.  2) Phone Number Setup short message senders phone number. By setting the phone number in FB parameter, only the SME with the setup phone number can manipulate a SMR FB. Up to 28 characters,including "+ , - * 0 1 2 3 4 5 6 7 8 9 ".  3) Number of RING Setup number of RING before call detection(Program Parameter, common for all CD FBs) Range:1 to 20
	R	Reset pin for the function block
	Output	The output is set ON, when the caller's number is equal to the stored phone number and E is ON. The output state is hold, when E is OFF, and it is reset (set OFF), when R input is ON.

#### 1) Asterix Character in phone number

The asterix character '\*' can be used to terminate phone number or can be stand-alone.

It takes place for any combination of numbers. Using the '\*', one CD FB can switch for a group of phone numbers.

**Table 6.49: Phone numbers and Outputs**

FB number	Caller's phone number	FB Output
+49 21 02 12 34 56 7	+49 21 02 12 34 56 7	Switched ON
+49 21 02 12 34 56 7	+49 21 02 12 34 56 8	no change
+49 21 02 12 34 56 7	+49 21 02 12 34	no change
+49 21 02 12 34 56 7	+49 21 02 12 34 56 78	no change
+49 21 02 12 34 56 7*	+49 21 02 12 34 56 7	no change
+49 21 02 12 34 56	+49 21 02 12 34 56 7	no change
+49 21 02 12 34 56 *	+49 21 02 12 34 56 7	Switched ON
+49 21 02 12 3*	+49 21 02 12 34 56 7	Switched ON
+49 21 02 12 3*	+49 21 02 12 34 56 8	Switched ON
+49 21 02 12 3*	+49 21 02 12 34 56 78	Switched ON
*	Any phone number	Switched ON
+*	Any international phone number	Switched ON

The phone number detection is inactive for 15 seconds after the last RING. A new incoming call within this guard time has no effect.

4 ) Sample VLS Program: Open roller shutter by phone call

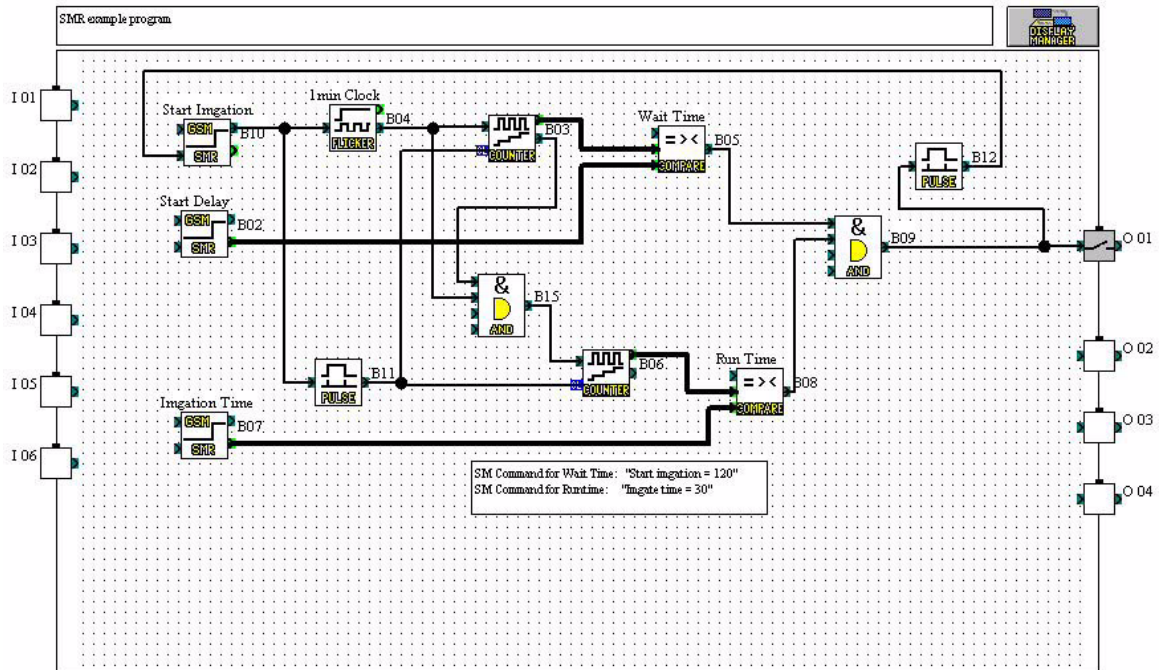

6.32.1 Number of RING

The number of RING before detection can be setup in FB parameter. It is common for all CD FB. The number of RING is the number of RING notifications, the modem sends to α2, not the number of RING a person hears at the telephone’s earphone.

α2 doesn’t answer the incoming call by Call Detection, so no connection is established.

For remote maintenance the connected modem has to be configured for automatic call answer by AT command ATSO like in older versions (V1.00 or 2.14). In case the setup number of RING before automatically call answer is set to a lower number than the number of RING before call detection, the Call Detect FB detects the phone number after the number of RING before automatically call answer.

ACK messages can be realized by using SMS FB together with CD FB.

Table 6.50: Action when the modem is called

Setup	Action when the modem is called
X = Y	When number of RING reached X, the CD FB detects the phone number and the modem answers the call.
X < Y	When number of RING reached X, the CD FB detects the phone number. Unless the number of RING doesn't exceed Y, the modem doesn't answers the call.
X > Y	When number of RING reached Y, the modem answers the call. Even if X is bigger than Y, the CD FB detects the phone number.

X: Number of RING before Call Detect

Y: Number of RING before the modem automatically answers an incoming call



The Call Detect FB operates only by an simple handing failure. So, install some safety device according to system.

### 6.33 Random One Shot Block

This Function Block is equivalent to the One Shot function block except that the new block has only randomly generated pulse time. An Upper and Lower Time Limit value can be set in increments of 10 ms (0.00 to 327.67 seconds), 100 ms (00.0 to 3276.7 seconds), and 1 second (0 to 32767 seconds) for the random number generation. If the Input signal turns Off during the pulse interval, the Output is Reset along with the pulse time.

**Table 6.51: Random One Shot function block**

Function	Set Item	Description
	I	Input pin for the random one shot function block
	C	Clear pin for the random one shot function block
	FB	1) A random one shot time is generated between the upper and lower threshold values. 2) The random value only occurs in correlation to the ON status of the input. 3) The clear signal input reset the output, random one shot value and current time. 4) If the Upper threshold is equal to or larger than the lower threshold, the random one shot time is set in the range lower threshold to upper threshold. 5) If the Upper threshold is less than the lower threshold, the random one shot time is set in the range 0 to upper threshold or lower threshold to 32767. 6) If the lower threshold = Upper threshold, the random one shot is equal to the upper threshold = lower threshold. 7) Time units: 10ms, 100ms or 1s (*Note)
	Output	1) The following items are available for other function blocks: a) Random One Shot value b) Current One Shot value



**Note:**

The set time cannot be less than one scan time for the controller; otherwise, the Random One Shot Function Block will not perform its assigned task for the time specified. Users can monitor the scan time from the α2 Series Controller. Scan time is dependent on the user-program; therefore, caution is needed as and when time units are selected.

Setup of the Random One Shot Function Block directly from the α2 Series Controller

- 1) Allocate the input pin to be used for the function block.
- 2) Press the “OK” key with the cursor in the function block.  
The function block edit screen is displayed as shown.

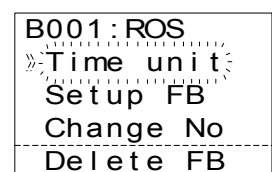

- 3) Press the “OK” key to set the Time unit for the random delayed output. Choose either a 10ms, 100ms or 1s time interval using the “▲ and ▼” keys to highlight the option and press the “OK” key when ready.

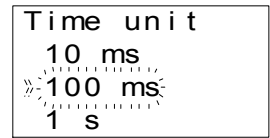

- 4) Return to the function block edit screen. Using the “▲ and ▼” keys highlight the Setup FB and press the “OK” key.

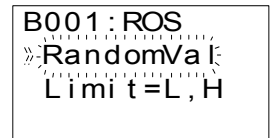

- 5) A RandomVal in conjunction with the specified time units allocated earlier can be entered from pressing the “OK” key having highlighted the RandomVal option using the “▲ and ▼” keys. Press the “▼” key hence highlighting the 0s time value and use the “+ or -” keys to enter a time value. Press the “OK” key to accept and return to the function block setting screen.

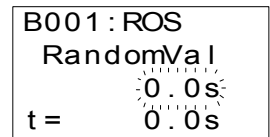

- 6) Highlight the Limit:L,H option and press the “OK” key. A high and low limit can be set for the Random One Shot function block. Using the “▲, ▼, + and -” keys enter values for the high and low limits in accordance with the time intervals specified earlier.

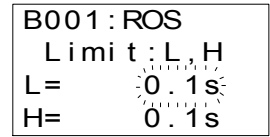

- 7) Press the “OK” key to accept the High and Low limit subsequently. Use the “ESC” key to return to the FBd.

### 6.34 Delayed One Shot Block

This block is equivalent to a combination of the Delay and the One Shot function block. Set an ON delay for the rising pulse of the Input signal or an OFF delay for the falling pulse. This FB will process the ON delay time before turning the Output ON for the OneShot pulse time and/or delay the Output resetting until the OFF delay time has processed.

**Table 6.52: Delayed One Shot Function Block**

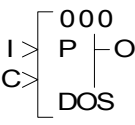
Function	Set Item	Description
	I	Input pin for the delayed one shot function block
	C	Clear pin for the delayed one shot function block
	FB	1) Delay Time a) OFF to ON b) ON to OFF  2) Delay Time range: 0 to 32767  3) One Shot Time range: 0 to 32767  4) Time units: 10ms, 100ms or 1s (*Note)  5) When the Clear signal is set ON, the current Delay Time, current One Shot Time will be cleared. The Output will reset OFF.
	Output	The following items are available for another function block: 1) Word Output a) Delay b) Current Delay c) One Shot d) Current One Shot



**Note:**

The set time cannot be less than one scan time for the controller; otherwise, the Delayed One Shot Function Block will not perform its assigned task for the time specified. Users can monitor the scan time from the α2 Series Controller. Scan time is dependent on the user-program; therefore, caution is needed as and when time units are selected.

1) Delayed One-Shot (Delay starts when OFF to ON)

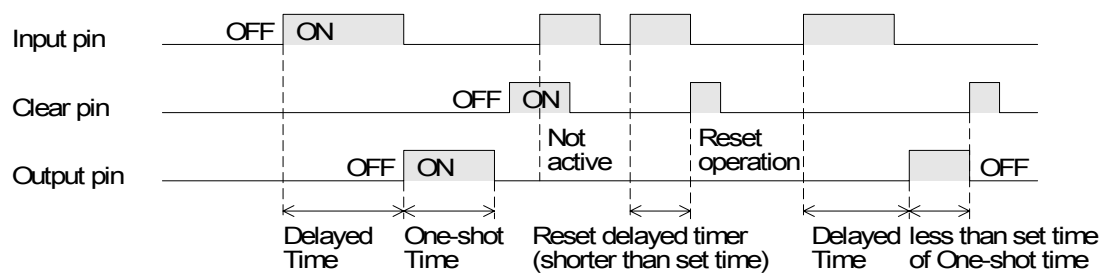

2 ) Delayed One-Shot (Delay starts when ON to OFF.)

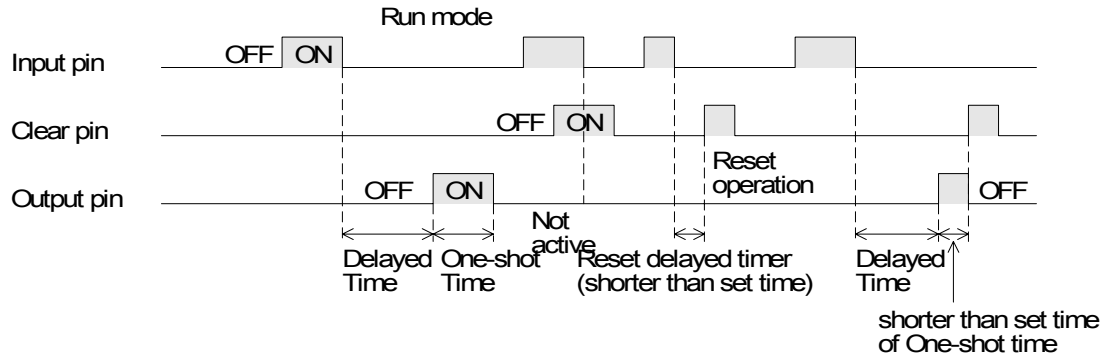

3 ) Delayed One Shot sample program

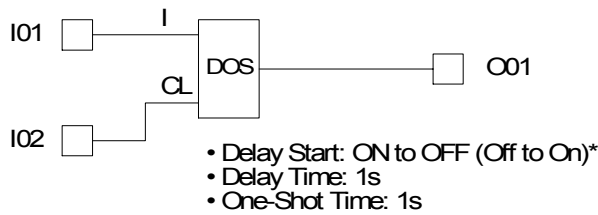

4 ) Delayed One Shot comparison sample program

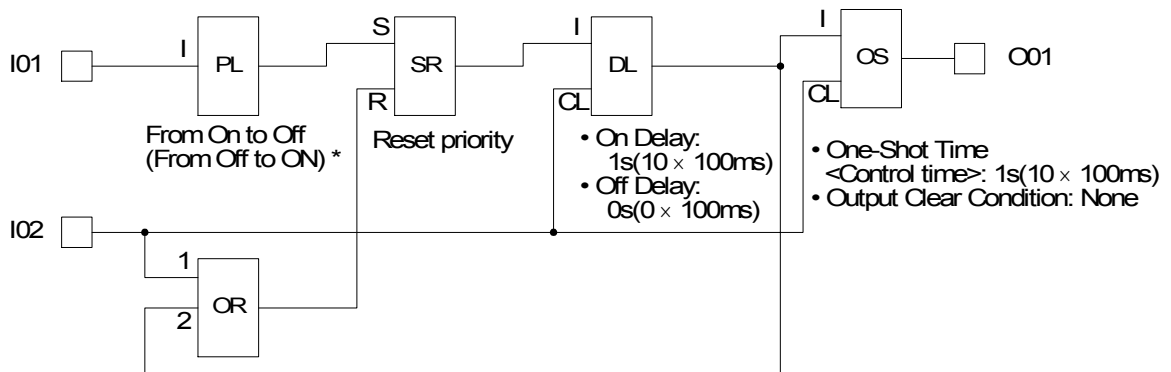

Setup of the Delayed One Shot Function Block directly from the α2 Series Controller

- 1 ) Allocate the input pin to be used for the function block.
- 2 ) Press the “OK” key with the cursor in the function block. The function block edit screen is displayed as shown.

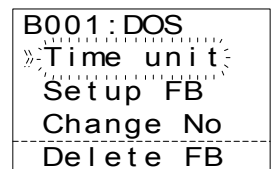

- 3 ) Press the “OK” key to set the Time unit for the random delayed output. Choose either a 10ms, 100ms or 1s time interval using the “▲ and ▼” keys to highlight the option and press the “OK” key when ready.

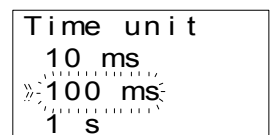

- 4 ) Return to the function block edit screen. Using the “Up and Down” keys to highlight the Setup FB and press the “OK” key.

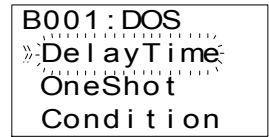

- 5 ) Highlight DelayTime from the list of options and press the “OK” key. The Delay Time can be entered using the “▲, ▼, + and -” keys.

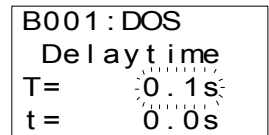

- 6 ) Highlight OneShot from the list of options and press the “OK” key to enter times. The One Shot Time can be entered using the “▲, ▼, + and -” keys.

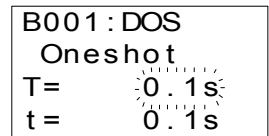

- 7 ) Highlight Condition from the list of options and press the “OK” key to enter either a RiseEdge or a FallEdge for the Delayed One Shot Operation.

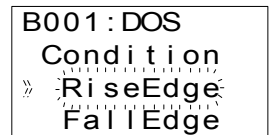

- 8 ) Press the “OK” key to accept and use the “ESC” key to return to the FBd.

### 6.35 Delayed Alternate Block

The function block is used to generate a delayed alternate pulse to the output pin of the function block.

**Table 6.53: Delayed Alternate Function Block**

Function	Set Item	Description
	I	Input pin for delayed alternate function block
	C	Clear pin for delayed alternate function block
	FB	1) Time units: 10ms, 100ms or 1s (*Note) 2) Delay Time range: 0 to 32767
	Output	The following items are available for another function block: 1) Word Output a) Delay set value b) Current value of delay time 2) Bit output a) The delay action occurs after the function block sees the rising edge of the input signal. b) After the specified Delay time, the Output signal changes state c) When the Clear Input signal sets ON, the Current Delay Time is cleared and the Output signal will reset OFF.



Note: The delay time cannot be less than one scan time for the controller; otherwise, the Delayed Alternate Function Block will not perform its assigned task for the time specified. Users can monitor the scan time from the α2 Series Controller. Scan time is dependent on the user-program; therefore, caution is needed as and when time units are selected.

#### 1) Delayed Alternate Operation

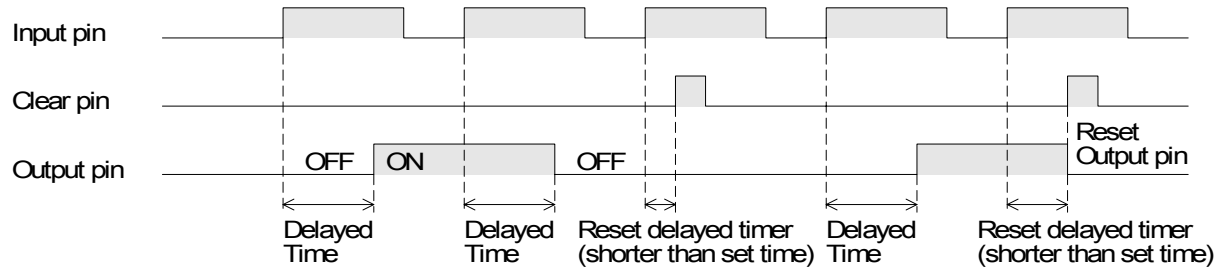

#### 2) Delayed Alternate sample program

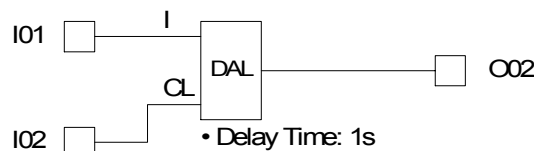

#### 3) Delayed Alternate comparison sample program

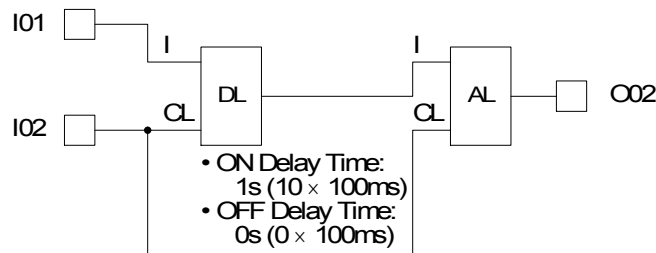



Setup of the Delayed Alternate Function Block directly from the α2 Series Controller

- 1 ) Allocate the input pin to be used for the function block.
- 2 ) Press the “OK” key with the cursor in the function block. The function block edit screen is displayed as shown.

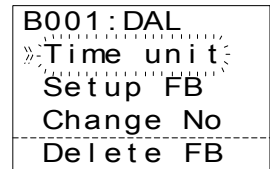

- 3 ) Press the “OK” key to set the Time unit for the delayed alternate output. Choose either a 10ms, 100ms or 1s time interval using the “▲ and ▼” keys to highlight the option and press the “OK” key when ready.

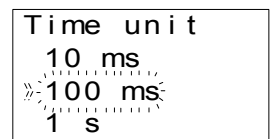

- 4 ) Return to the function block edit screen. Using the “▲ and ▼” keys highlight the Setup FB and press the “OK” key.

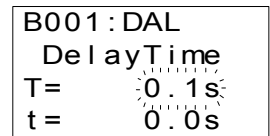

- 5 ) Press the “OK” to accept subsequently use the “ESC” key to return to the FBd.

### 6.36 Retentive Set Reset Block

The function block operates is identical in operational procedure as the Set/ Reset function block, however, a retentive option has been provided for the user to hold the state of the output after the power has been turned OFF.

**Table 6.54: Retentive Set Reset Function Block**

Function	Set Item	Description
	S	Indicates the input is a set pin
	R	Indicates the input is a reset pin
	FB	1) Priority a) Set b) Reset
	Output	The output of the function block operates in either an ON or OFF state. 1) Set the output ON until the reset pin is ON. 2) Decides the status of the output depending which input pin has priority. 3) Remember Output Signal status after a power cut.

1) Retentive Set Reset operation with reset priority

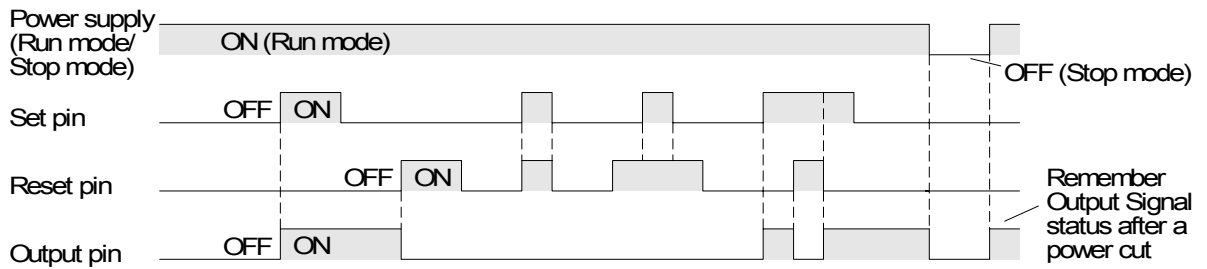

2) Retentive Set Reset operation with set priority

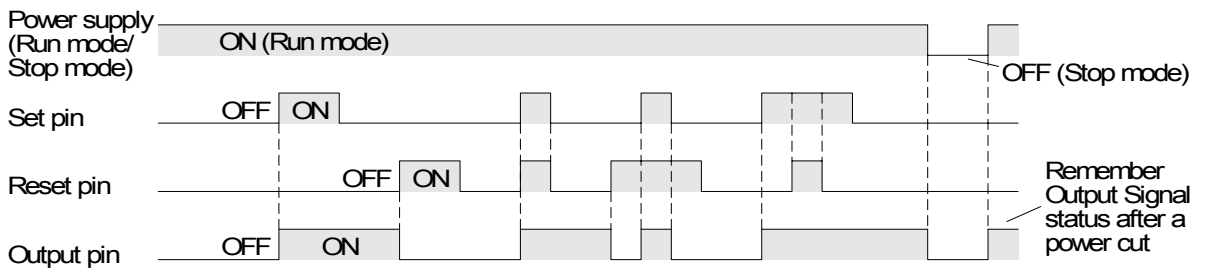

Setup of the Retentive Set/Reset Function Block directly from the α2 Series Controller

- 1 ) Allocate the input pin to be used for the function block.
- 2 ) Press the “OK” key with the cursor in the function block. The function block edit screen is displayed as shown.

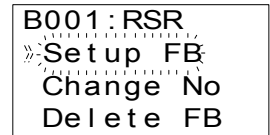

- 3 ) The function block operates on a Set or Reset priority. Select the priority using the “▲” and “▼” keys and subsequently press the “OK” key.



- 4 ) Press the “OK” key and use the “ESC” key to return to the FBd.

### 6.37 Control Display Manager

Display Manager controls the sequence of user screens to be displayed according to the signal that specifies each user screens. When N04 has been turned ON, Display Manager becomes effective. The user screen set with Display Manager is displayed on the α2 series. The displayed user screen can be composed up to 10 Display function blocks. However, the Display Manager can only be set using a combination of an α2 Series Controller and the AL-PCS/WIN-E Ver. 2.00. The Control Display Manager cannot be programmed using the controller alone..

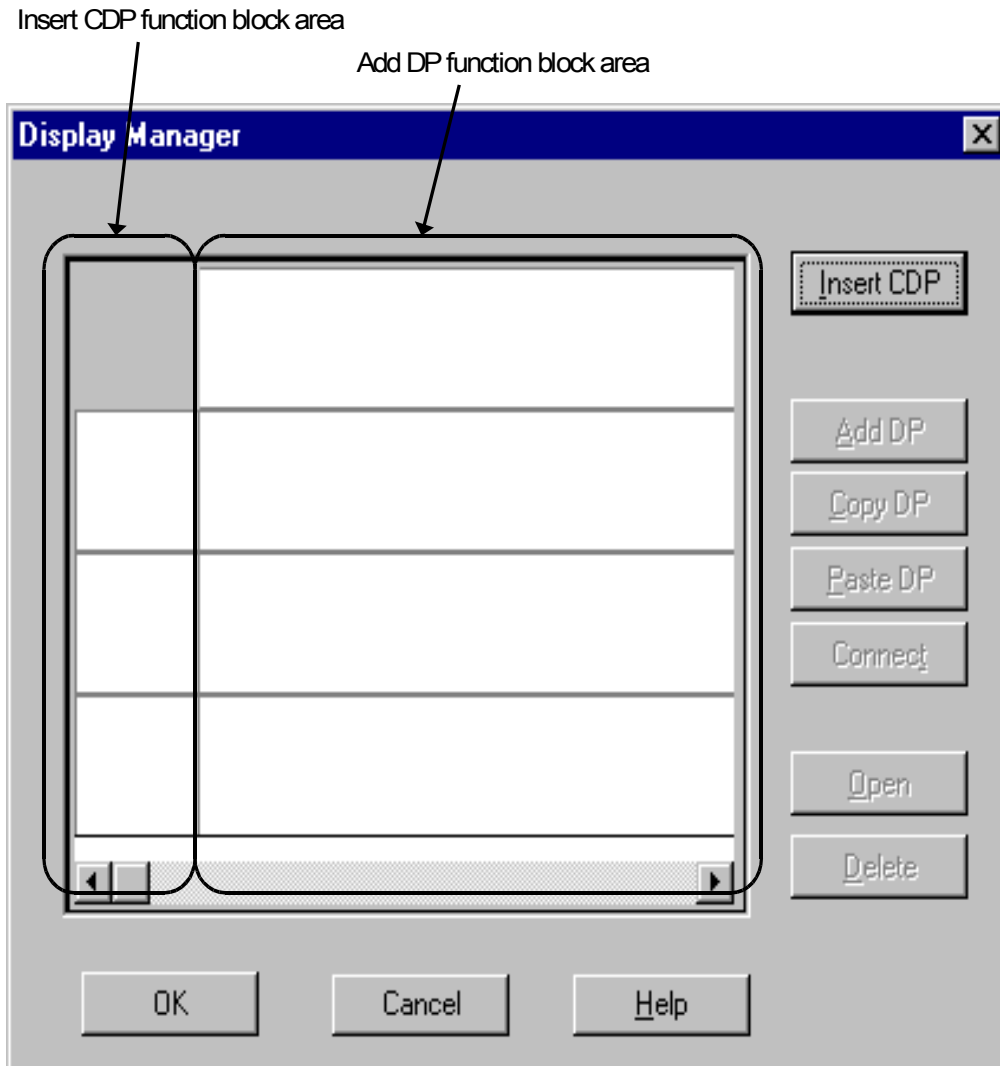

6.37.1 Operation Image:

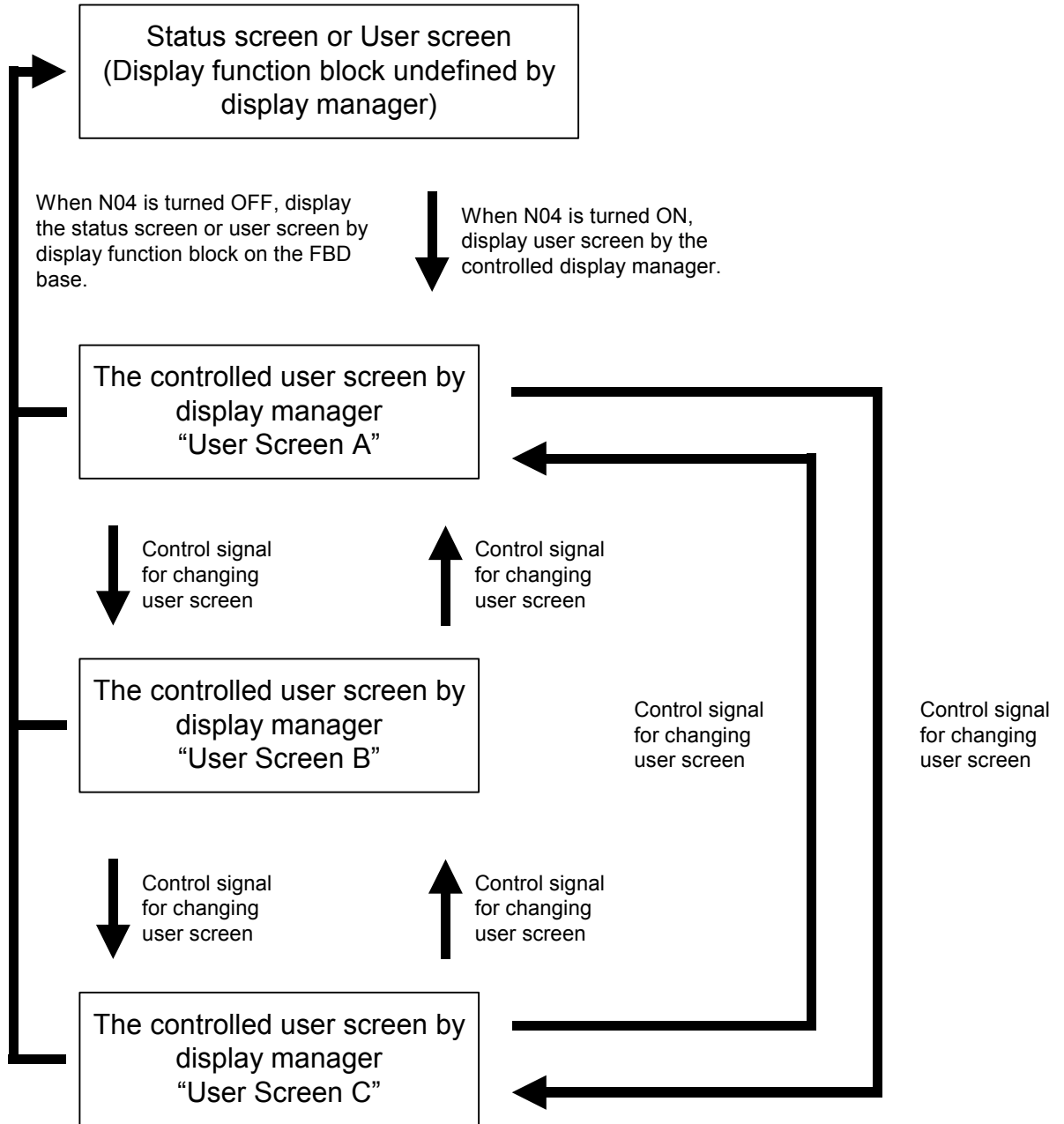

### 6.37.2 To Set Display Manager:

- 1) Double click the “Display Manager” button on the FBD base window.

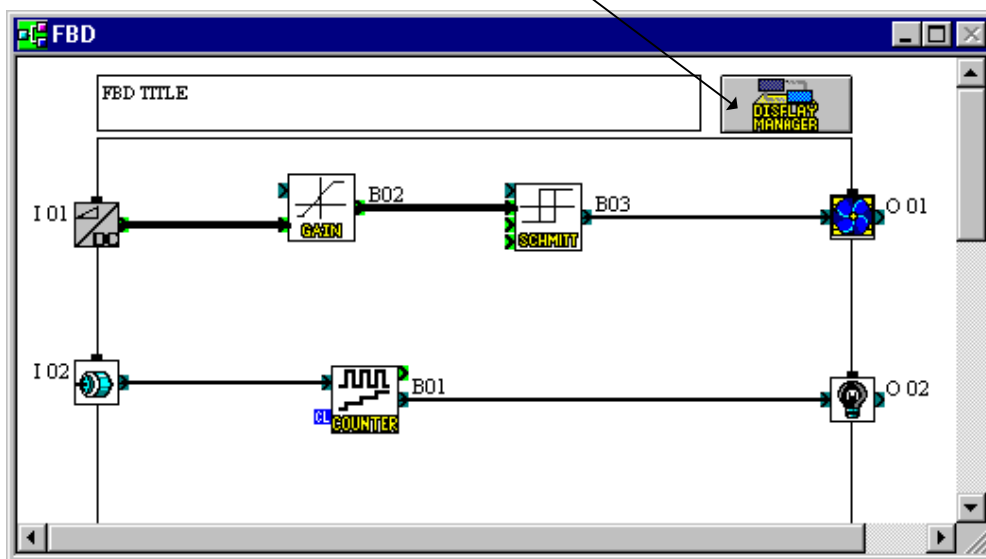

- 2) Click the “Insert CDP” button to Insert CDP function block for the control user screen function

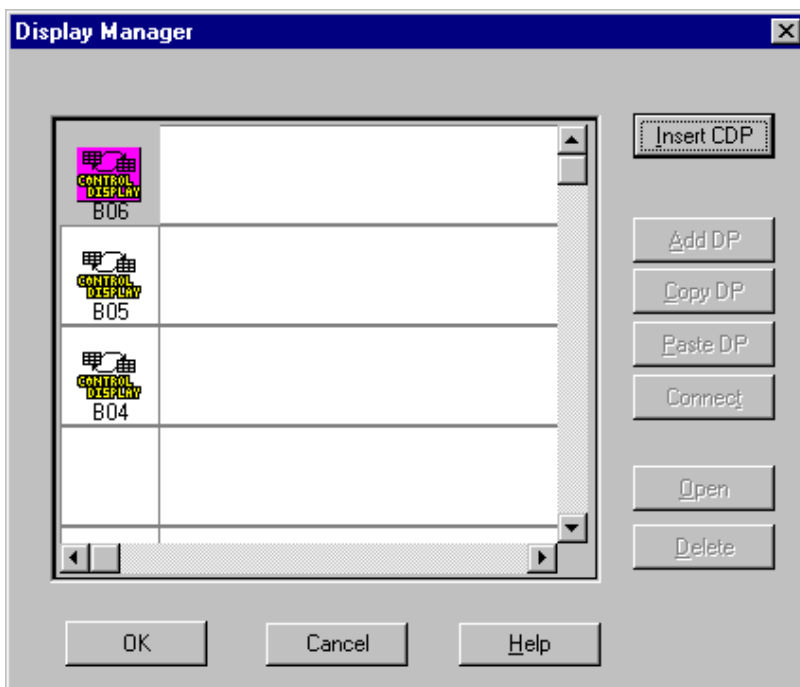

- 3) Choose the “CDP (Control Display Function)” icon to add a DP (Display function block) for each user screen.

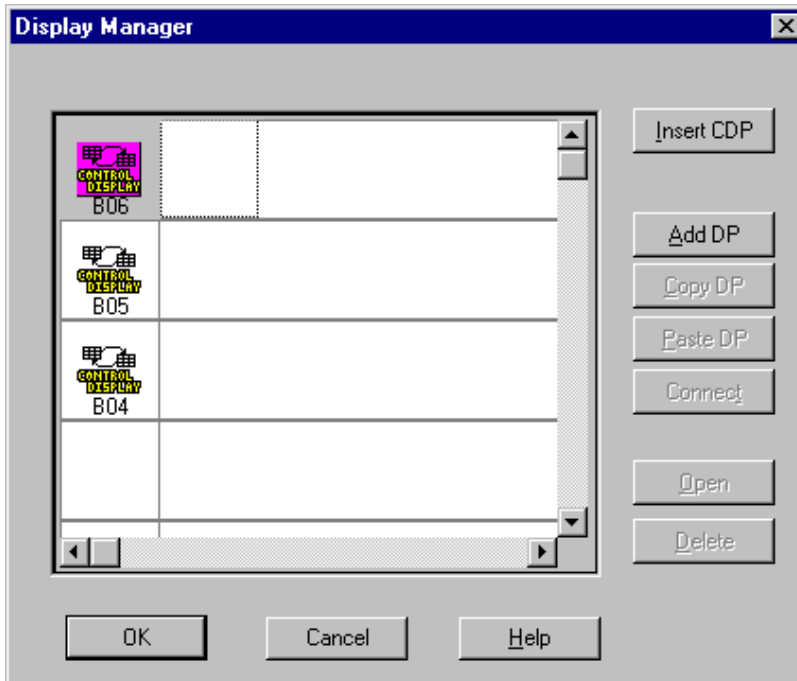

- 4) Click the “Add DP” button to add DP function block(s) for the CDP function block. It is possible to add a maximum of 10 DPs into 1 CDP.

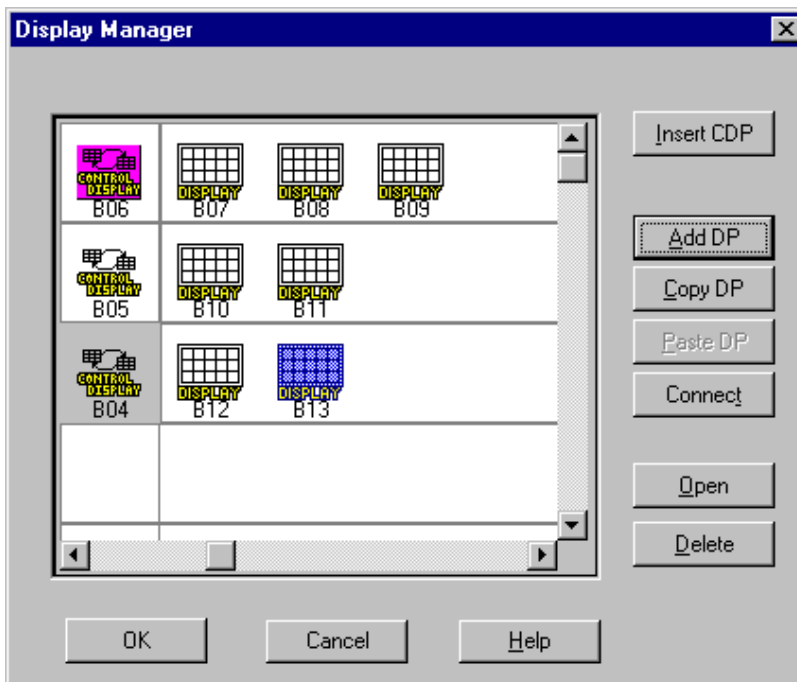

- 5) Choose the “Display” icon for indication FB (Function Block) or Analog value, and click “Connect” button.  
When not displaying them, please go to step 7).

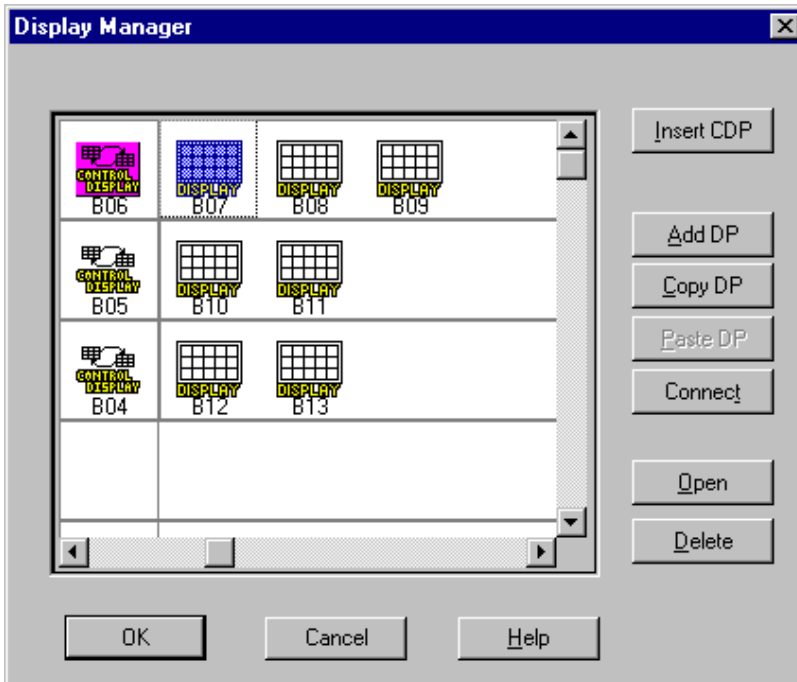

- 6) Click the “Connect” button to display the FB value or the Analog Input value
- **Free:** Displays the Text, Date or Time. (Default setting)
  - **FB Word Output:** Displays FB value. Choose function blocks from list.
  - **Analog Input:** Displays Analog Input value. Choose Analog Input port.
- When completing connection, click the "OK" button.

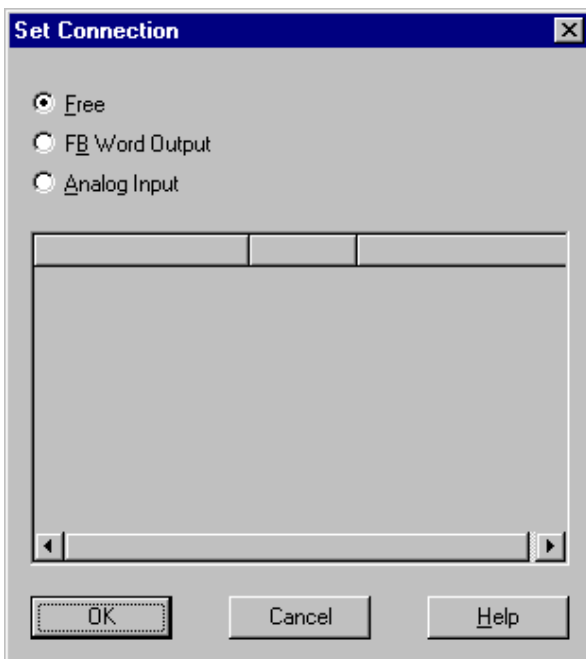



- 7) Double-click the “Display” icon or click the “Open” button to set parameters. Further information about parameters of the Display function block can be found in the programming manual and “Help” on the AL-PCS/WIN-E.  
On completion of the parameter settings, click the “OK” button.

**Choosing “Free” on step 6)**

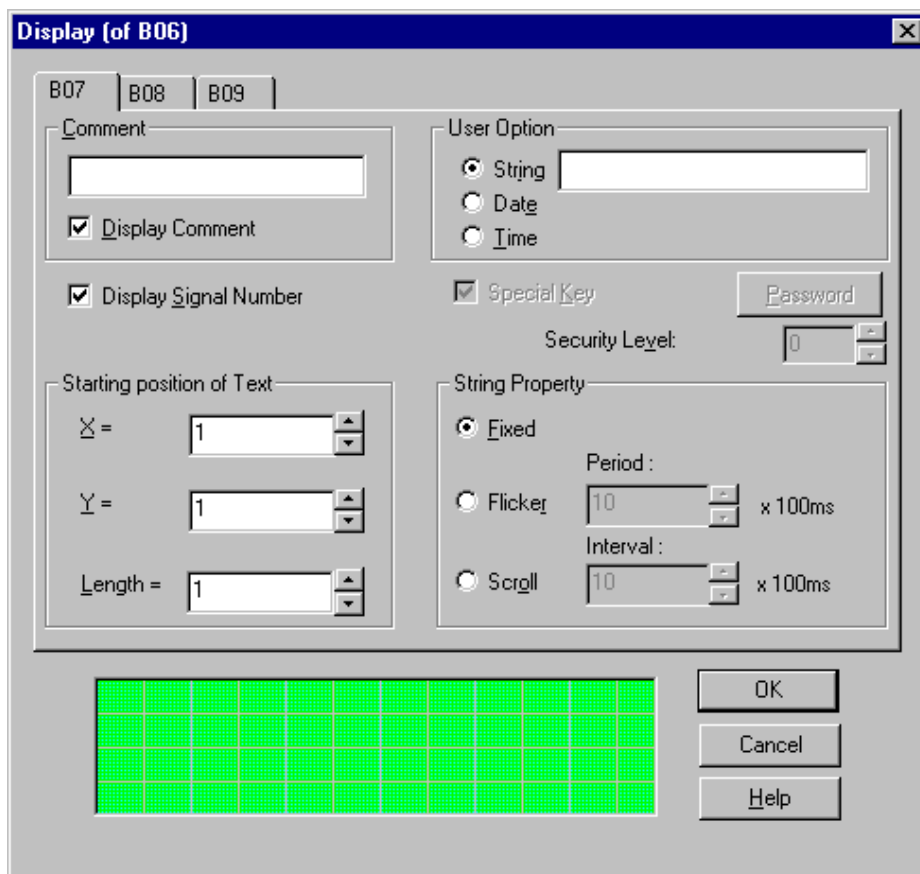

Choosing “FB Word Output” on step 6)

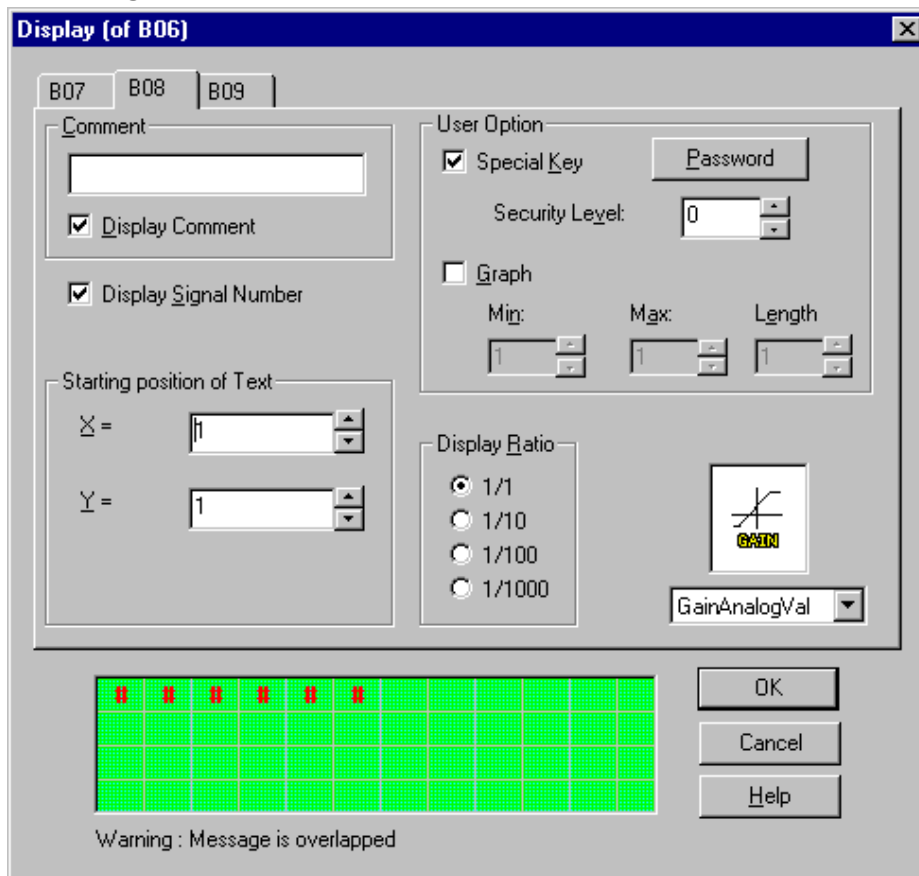

Choosing “Analog Input” on step 6)

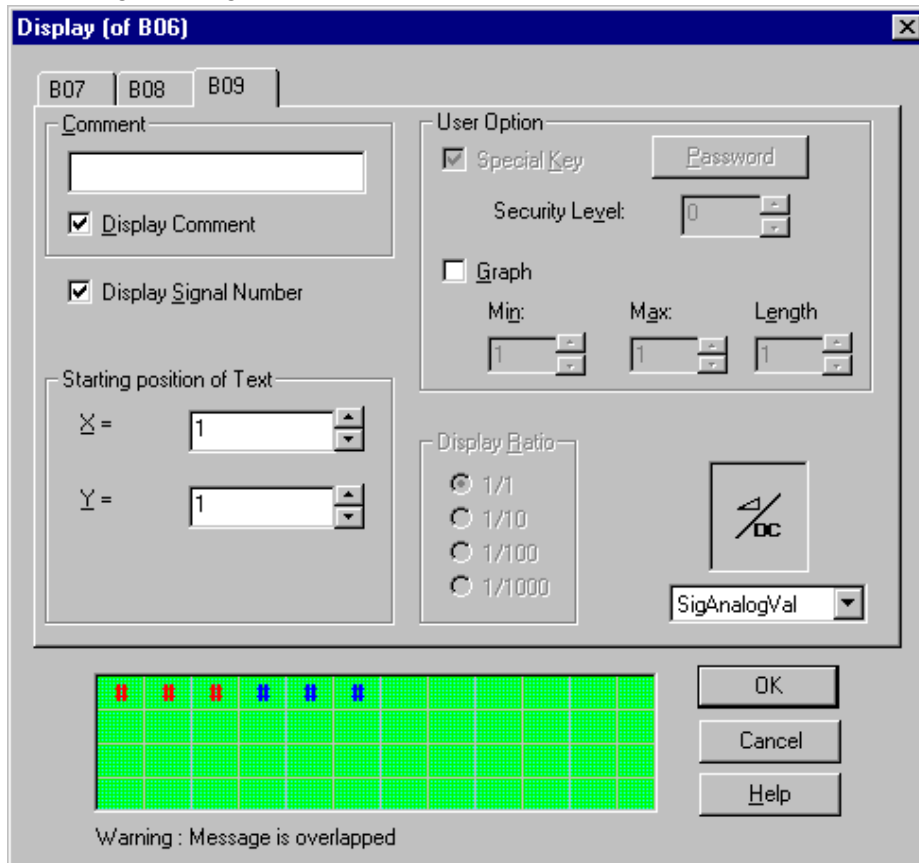

8) Double-click the “CDP” icon or click the “Open” button to set parameter.

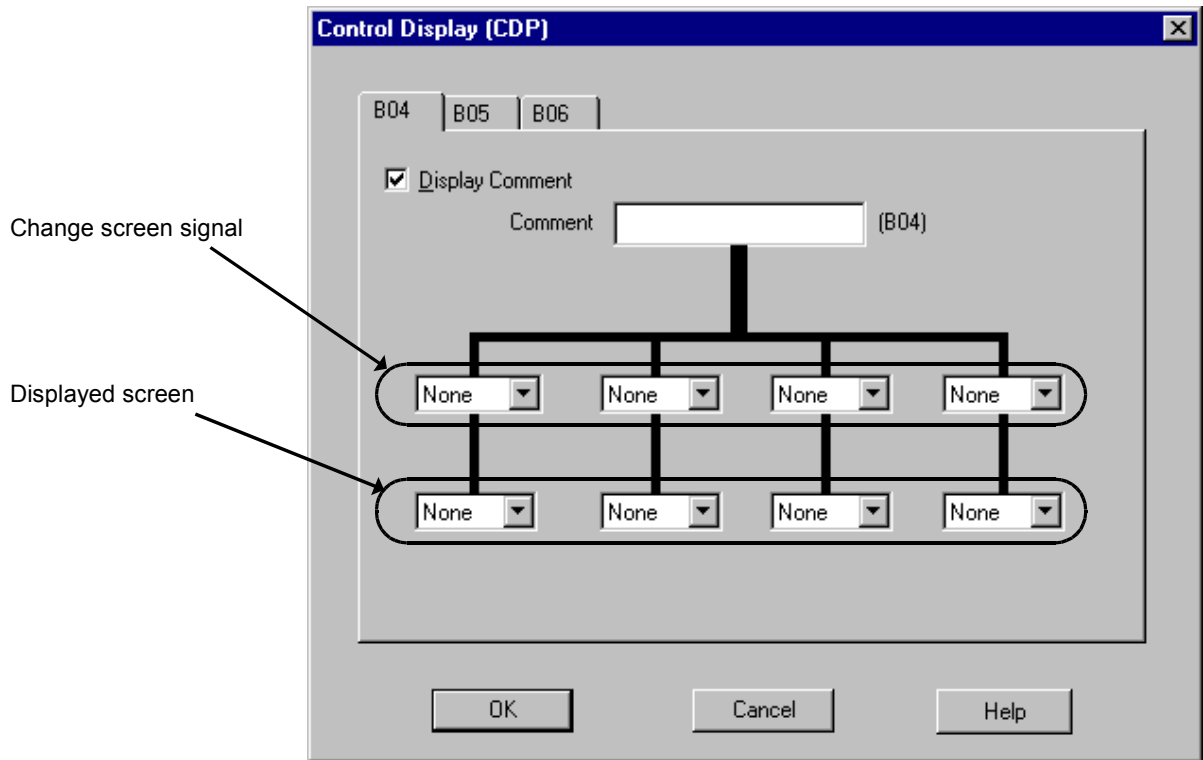

9) Select the signal for changing user screens from the pull-down menu options.

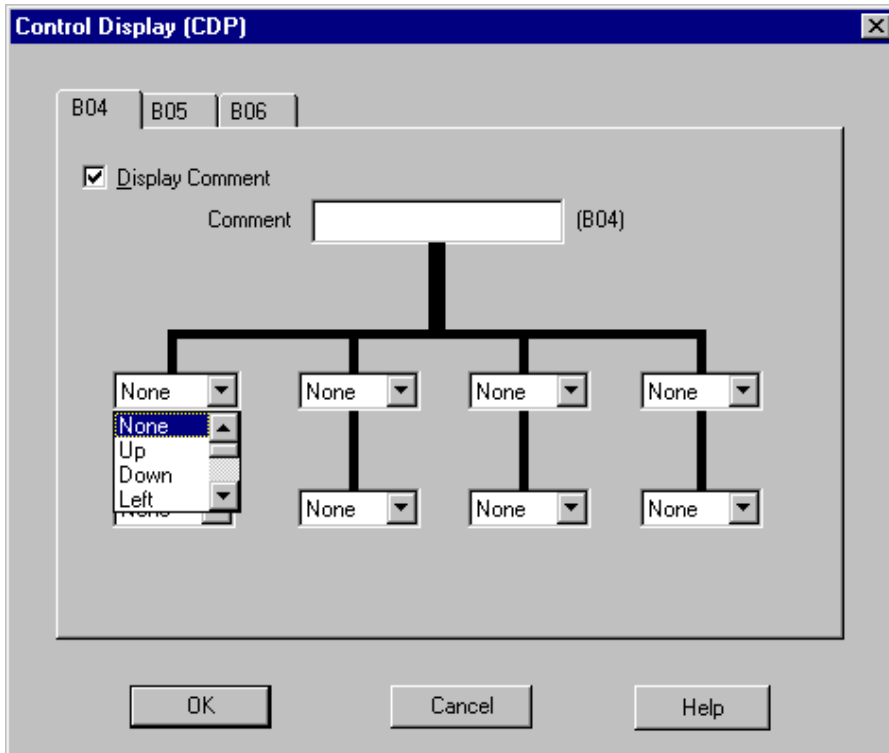

- 10) Select the next displayed user screen from the pull-down menu options. When completing the control key setting, click the "OK" button.

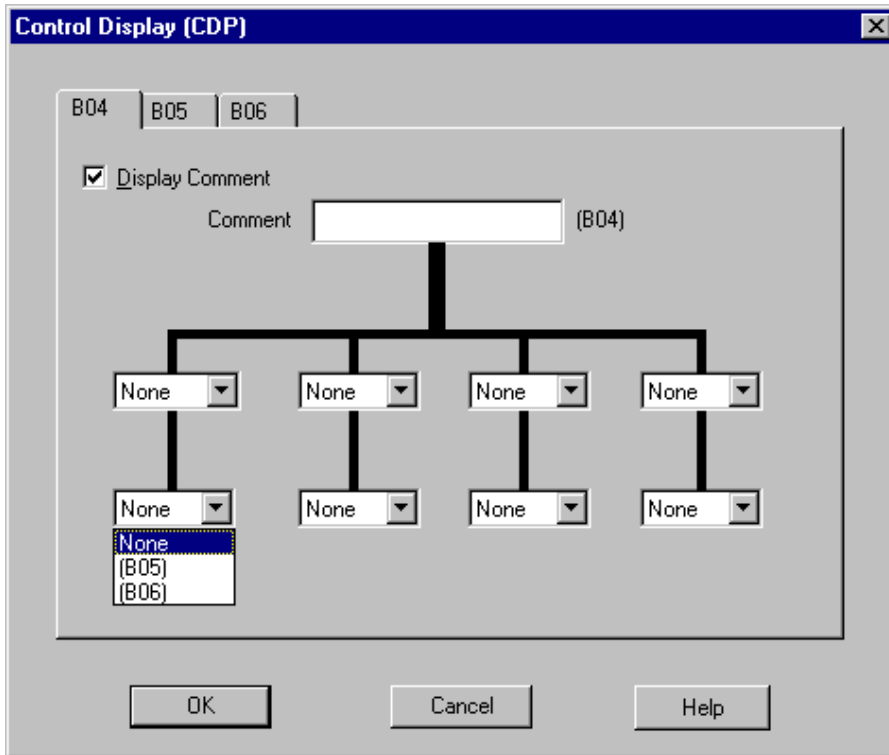

- 11) When completing the control key's setting, click the "OK" button.

### 6.38 Connect Block

The Connect function block is an internal device used to show the memory used by input bits, system bits, AS-interface bits, and the operation keys. No function block appears on screen or shows as being used in the "Memory Configuration Usage" dialog box, the purpose is only to calculate the memory that is used by the bits listed above.

**Table 6.55: Connect Function Block**

Function	Set Item	Description
	I	Input pin for the Connect Function Block.
	Output	<p>The output ON/OFF status is controlled by the condition of the input signal.</p> <p>1) The output signal will be high if the input signal is ON. The output signal will be low if the input signal is OFF.</p> <p>2) If the input pin is disconnected the ON/OFF status of the output can be controlled from AL-PCS/WIN-E installed onto a personal computer.</p>

## 7. Let's Make a Program

Let's create a sample program from beginning to end. Power up the α2 and press any key to go the TopMenu.

### 7.1 Option Settings

Before starting to program, we can set any desired options from the following list.

Refer to Chapter 3 for option settings

- Language
- Real Time Clock Set
- Others...: Password, Dispass, Summertime Clock, Menu Key, Light Time and Serial Communication

For the program below, none of the above options need be set. Use the ProgClear to erase the current memory contents with "OK". To confirm the memory erase, press "OK" again.

### 7.2 The Function Block Diagram

The system Inputs I01, I02, and I03 are shown on the left of the diagram and the system Outputs O01, O02, and O03 are shown on the right. The function blocks are numbered in the order that they are added to the program.

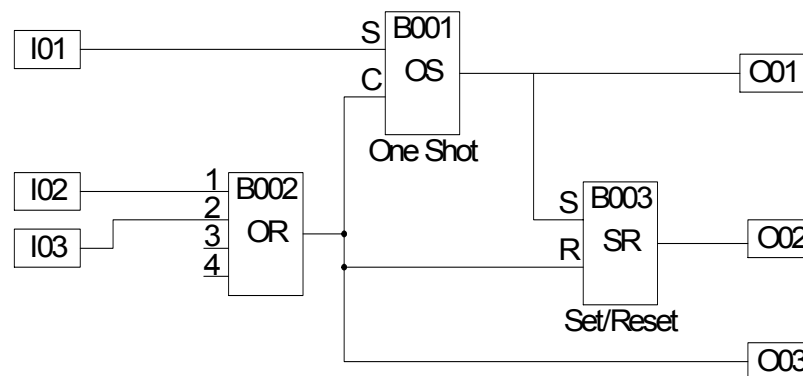

The input pins are shown on the left side of the FB and the output pins are shown on the right side of the blocks. Note that each input pin can receive only one signal but the output pins can provide signals to multiple sources.

### 7.3 Input the Program

The options are set and the Function Block diagram is finished. It is time to start inputting the program. From the TopMenu enter ProgEdit to begin programming using the front keys as described in Chapter 4 Direct Programming.

If during the course of the programming you wish to begin again, use the "ESC" key to enter the Edit Menu. Use the Exit option to go back to the TopMenu. Erase the memory using ProgClear and begin again.

#### 7.3.1 Adding Function Blocks by the Left to Right method (Section 4.2.1)

The first block that is shown will be the Input Block I01 with the Input number 01 flashing. Press the "+" or "-" keys to scroll through the available programming blocks including Outputs, M bits, Keys, and the Inputs. Return to I01. Press the (▶) arrow key. The output pin should now be flashing.

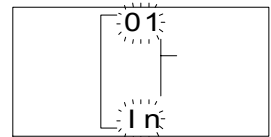

Press "+" to attach a function block to Input I01. The options available to connect to the Input block will be shown on the right hand side of the screen. Use the (▲) and (▼) arrows to move to the option to select, AddFB. Enter "OK".

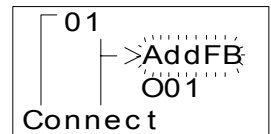

The FB select menu containing all 35 Function Blocks (including logic blocks) will appear (picture). Again, use the (▲) and (▼) arrows to scroll to the desired Function Block, in this case the One Shot (OS) Function Block. Use the "OK" button to accept.



The OS block has two input pins, the Input Pin on top and the Clear Pin beneath. Use the (▲) and (▼) arrows to choose the desired pin, in this case the Input pin. Confirm using the "OK" button.

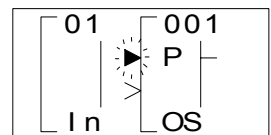

Use the (▶) arrow twice to move right until the OS output pin is flashing (picture). Enter the "+" key to add a block. There is no need to enter the AddFB mode because O01 will appear on the list of blocks to add. Use the (▲) and (▼) arrows to scroll to O01, accept with the "OK" key, and then confirm with the "OK" key.

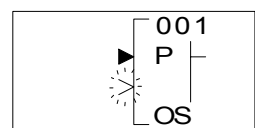

### 7.3.2 Scroll through the Function Blocks by Number (Section 4.6.1)

When the Output has been connected, move one space to the right so that the Output number "01" is flashing. Use the "+" key to scroll through to Input I02. (You will scroll through the Outputs, Keys, M bits, and finally get to the Inputs).

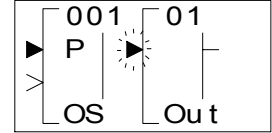

Move to the right one space so that the output pin is flashing. Connect I02 to the OR block, (the same procedure as connecting I01 to the One Shot Block). The input pins for the OR Block are equivalent so that any input pin can be chosen. [The key sequence for the OR Block addition is "OK", scroll to AddFB, "OK", scroll to OR, OK, OK].

Move right until the OR output pin is flashing. Connect Output O03 in the same manner that O01 was added. [The key sequence will be "OK", scroll to O03, OK, OK].

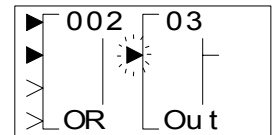

With the OR output pin still flashing (see diagram at right), press the "+" key again. The output pin of the OR block can be connected to another location.

Scroll to "B01OS" and press "OK". The OR block and the OS block can now be connected through the Clear pin (picture). Since the OS Input pin on top has already been filled, there can be no further connection to that pin.

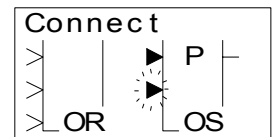

Press "OK" to accept the connection to the "C", or Clear pin. They are now connected together.

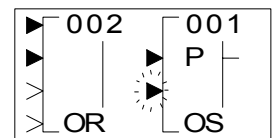

### 7.3.3 Use the Jump Command (Section 4.6.3)

Press the ESC key to enter the Edit Menu. Choose the Jump option. Use the (◀) key to move to the I column. Use the "+" key to move to I03 and accept with the OK key. Input I03 should now be shown on the LCD.



Connect to the OR block [(▶), "+", scroll to B02OR (it should not be necessary to move in this case), "OK", "OK"].

### 7.3.4 Use the NewFB command

Use the "ESC" key to enter the Edit Menu again. On this occasion enter the New FB option. Scroll to the Set/Reset FB and select with the "OK" button. The SR diagram should now appear on the LCD.

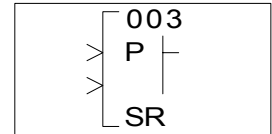

### 7.3.5 Connect the Function Blocks from Right to Left (Section 4.2.2)

Move to the left until one of the two input pins is flashing. The top pin is the Set pin which will be connected to the OS block. The Reset pin on bottom will be connected to the OR block. Move to the Set pin and press the "+" key; the available blocks to add will be shown on the left of the screen. Scroll down through the choices until B01OS is shown (picture). Use the "OK" to choose the block, then the "OK" key again to confirm the choice.

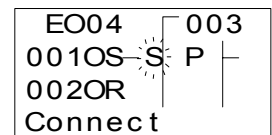

Use the (▼) arrow to move down to the Reset pin. Connect the OR block using the same procedure. ["+", scroll (▼) to B02OR, "OK", "OK"]

Move to the SR output pin and connect Output O02 using the Left to Right method of connecting blocks. [(▶), (▶), "+", scroll to O02, "OK", "OK"].

Move back to the left one space. The following diagram should now be showing on the LCD.

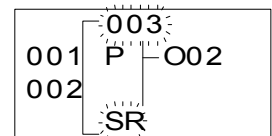



### 7.4 Set up the Function Block Parameters (Section 4.5.1)

The options for the Function Blocks now need to be Set.

Move left until the SR Function Block number (03) is flashing. Press the "OK" to enter the FB Edit Menu and press "OK" again to enter the Setup FB option. Choose the Reset option and enter the data into program memory with the "OK" button.



This is the only option in the SR Function Block. Use the "ESC" key to return to the Function Block Diagram board.

The OR Block, like all the Logic Blocks, does not have any parameters that can or need to be set.

Proceed to the One Shot Function Block. Use either the Jump command, trace the path through the Set pin, or simply press the "+" key to scroll through the Function Blocks. When the One Shot Function Block number (01) is flashing, press the "OK" key once to enter the FB Edit Menu.

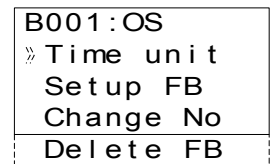

Select the Time unit option from the menu using the "OK" button. The One Shot Function Block allows for three different time increment settings: 10ms, 100ms or 1s.

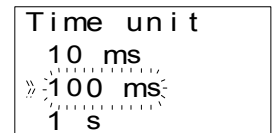

Select the 100ms time increment using the "OK" button. The controller will return to the FB Edit Menu. Select the Setup FB option from the Edit Menu. There are two option screens to be set.

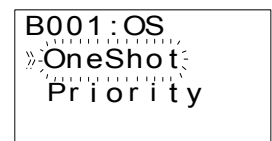

Enter the OneShot option screen using the "OK" button. The One Shot screen has two timers that can be set. The "T" timer is the Set Time for the One Shot block Output signal. The t timer is the elapsed time or actual time the OneShot has been ON. If a value is input for t, the first time the One Shot block is activated it will begin timing from the input value.

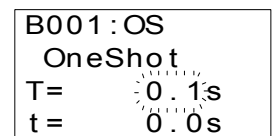

Use the “+” button to enter a value of 20.0 seconds in the T timer. Move down to the t timer and enter the value of 5.0 seconds. The “OK” button will accept the data for the entire screen. If the “OK” button is pressed before all the data on the screen is input, re-enter the screen and input the data. Data can be changed or edited in the same manner.

```
B001:OS
OneShot
T= 20.0s
t= 0.0s
```

Press the “OK” button to accept the values above. Move down to the Priority option and press the “OK” button. The Priority can be set for either Time or Input.

```
B001:OS
Priority
»Time«
Input
```

Move to the Time option and press the “OK” button. All the screen data has now been set. Return to the FBD using the “ESC” button. See Chapter 6 for details on the One Shot FB.

### 7.5 Exit the Function Block Diagram board

The programming is complete. To exit the FBD, press the “ESC” key to bring up the Edit Menu. Scroll to the Exit option and press “OK” to move to the Stop Mode TopMenu.

## 8. Appendix

### 8.1 Associated Manuals

	Manual Name	Manual No.	Description
⊙	α2 Hardware Manual	JY992D97901	This manual contains hardware explanations of wiring, installation and specification, etc. regarding the α2 Series Controller.
○	α Software Manual <English only>	JY992D74001	This manual contains explanations of operation regarding AL-PCS/WIN-E Programming Software.
○	α2 Series Communication User's Manual <English only>	JY992D97701	This manual contains setup explanations for messaging, diagnostics, bit assignments, etc. for communication using the α2 Series Controller.
□	α2 Series Installation Manual	JY992D97501	This manual contains hardware explanations for installation regarding the α2 Series Controller.
□	AL2-4EX, AL2-4EX-A2, AL2-4EYR, AL2-4EYT Installation Manual	JY992D97401	This manual contains hardware explanations for installation regarding the AL2-4EX, AL2-4EX-A2, AL2-4EYR and AL2-4EYT extension modules.
□	AL2-EEPROM-2 Hardware Manual	JY992D96801	This manual contains hardware explanations for installation regarding the AL2-EEPROM-2.
□	AL-232CAB Hardware Manual	JY992D76001	This manual contains hardware explanations for installation regarding the AL-232CAB.
□	AL2-GSM-CAB Hardware Manual	JY992D97201	This manual contains hardware explanations for installation regarding the AL2-GSM-CAB.
□	AL2-2DA Installation Manual	JY997D09301	This manual contains installation explanations for the AL2-2DA.
□	AL2-2PT-ADP Installation Manual	JY997D09401	This manual contains installation explanations for the AL2-2PT-ADP.
□	AL2-2TC-ADP Installation Manual	JY997D09501	This manual contains installation explanations for the AL2-2TC-ADP.
□	AL-ASI-BD, AL2-ASI-BD Hardware Manual	JY992D81401 JY992D81402	This manual contains hardware explanations for wiring, installation and specification, etc. regarding the AL-ASI-BD and AL2-ASI-BD.

⊙ Refer to these manuals.

○ Refer to this manual if necessary.

□ Refer to the content of these manuals if necessary though it is included in α2 Hardware Manual.

## 8.2 System Keys

Key Name	Key number	Key Function
OK	K01	Used to enter menu options, confirm data entry, and manually force inputs ON/OFF in the monitor function.
ESC	K02	Used to cancel an operation, move to a higher level screen, or to move to a new menu.
“+”	K03	Used to connect (or “add”) function blocks, increase Direct Set input values or times, or move through programs or menus.
“-”	K04	Used to disconnect function blocks, decrease Direct Set values or times, or move through programs or menus.
(▲)	K05	Scroll up through menu options (menus, keys, FB, Inputs, Outputs, etc.)
(▼)	K06	Scroll down through menu options (menus, keys, FB, Inputs, Outputs, etc.)
(▶)	K07	Move to the right on the LCD display, FB program, or Jump command
(◀)	K08	Move to the left on the LCD display, FB program, or Jump command

## 8.3 System Bits

System Bit	Description
M01	Always “ON”.
M02	Always “OFF”.
M03	Alternate - 0.5 seconds “ON”, 0.5 seconds “OFF”.
M04	“ON” when Real Time Clock data error occurs.
M05	“ON” when Summer time schedule is activated.
M06	“ON” when AS-interface communication Error occurs.
M07	“ON” when communication Error caused by AS-interface power failure occurs.
M08	Pulses “ON” when Stop mode turns to Run mode in the α2 Series.
M09	Pulses “OFF” when Stop mode turns to Run mode in the α2 Series.
M10	“ON” during DCF77 decoding
M11	Pulses “ON” when DCF77 finishes decoding without an error
M12	“ON” when CD (DCD) signal is turned ON (receiving CD signal from the modem.)
M13	“ON” when it is possible to access the GSM network.
M14	“ON” when the α2 series controller is accessed via GSM
M15	“ON” when DCF77 finishes decoding with an error
M16	“ON” when external power for the 2DA board is on
M17	“ON” when there is a sensor defect at I01
M18	“ON” when there is a sensor defect at I02
M19	“ON” when there is a sensor defect at I03
M20	“ON” when there is a sensor defect at I04
M21	“ON” when there is a sensor defect at I05
M22	“ON” when there is a sensor defect at I06
M23	“ON” when there is a sensor defect at I07
M24	“ON” when there is a sensor defect at I08

### 8.4 Boolean Gates

Logic Block State	Logic Block Displayed	Description	Memory Use	Section Reference
AND	<p>The diagram shows a logic block with four input pins labeled 1, 2, 3, and 4. The output pin is labeled 'O'. The block is labeled 'AND' at the bottom. A small '00' is shown above the block.</p>	This function executes logical AND operation on given input signals. The input signals connected should be of bit input type only. 4 Bit input pins and 1 Bit output pin. If all the inputs are ON then the output is ON, otherwise output is OFF.	19 Byte	5.1
OR	<p>The diagram shows a logic block with four input pins labeled 1, 2, 3, and 4. The output pin is labeled 'O'. The block is labeled 'OR' at the bottom. A small '00' is shown above the block.</p>	This function executes logical OR operation on given input signals. The input signals connected should be of bit input type only. 4 Bit input pins and 1 Bit output pin. If all the inputs are OFF then output is OFF, otherwise output is ON.	19 Byte	5.2
NOT	<p>The diagram shows a logic block with one input pin labeled 1 and one output pin labeled 'O'. The block is labeled 'NT' at the bottom. A small '00' is shown above the block.</p>	This function executes logical NOT operation on given input signal. The input signal connected should be of bit input type only. 1 Bit input pin and 1 Bit output pin. Output is negation of Input given.	10 Byte	5.3
XOR	<p>The diagram shows a logic block with two input pins labeled 1 and 2, and one output pin labeled 'O'. The block is labeled 'XOR' at the bottom. A small '00' is shown above the block.</p>	This function executes logical XOR operation on given input signals. The input signals connected should be of bit input type only. 2 Bit input pins and 1 Bit output pin. If both the inputs are either OFF or ON then output is OFF, otherwise output is ON.	13 Byte	5.4
NAND	<p>The diagram shows a logic block with four input pins labeled 1, 2, 3, and 4. The output pin is labeled 'O'. The block is labeled 'NAND' at the bottom. A small '00' is shown above the block.</p>	This function executes logical NAND operation on given input signals. The input signals connected should be of bit input type only. 4 Bit input pins and 1 Bit output pin. If all the inputs are ON then output is OFF, otherwise output is ON.	19 Byte	5.5
NOR	<p>The diagram shows a logic block with four input pins labeled 1, 2, 3, and 4. The output pin is labeled 'O'. The block is labeled 'NOR' at the bottom. A small '00' is shown above the block.</p>	This function executes logical NOR operation on given input signals. The input signals connected should be of bit input type only. 4 Bit input pins and 1 Bit output pin. If all the inputs are OFF then output is ON, otherwise output is OFF.	19 Byte	5.6

## Function Blocks

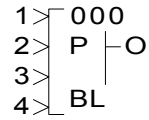
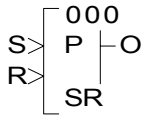
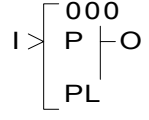
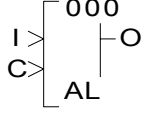
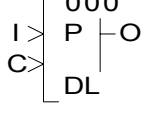
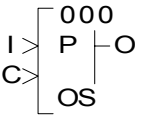
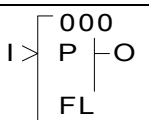
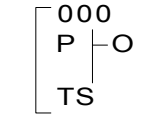
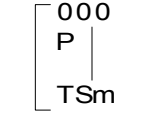
FB Name	FB Symbol	Description of Function Block	Memory Use	Section
Boolean [BL]		The Boolean Function Block uses Boolean algebra to control the ON/OFF state of an output. An operational expression consists of either the AND, OR, XOR or NOT form.	*1	6.3
Set/Reset [SR]		The Set/Reset Function Block either holds an output ON (set) or releases the output OFF (reset.) Priority can be given to either input pin if both inputs have been energised simultaneously. The default priority setting is dedicated to the reset input pin.	14 Byte	6.4
Pulse [PL]		The Pulse Function Block sends a single pulse to the output pin if the input pin receives either an "ON to OFF", "OFF to ON" or "ON to OFF And OFF to ON" input operation.	10 Byte	6.5
Alternate [AL]		The Alternate Function Block is used to reverse the ON and OFF state of the output as and when the input pin receives a signal. The output will be set ON when the input pin goes high and remain ON until the input receives the second rising edge.	13 Byte	6.6
Delay [DL]		The Delay Function Block provides an ON delay timer and an OFF delay timer. Time intervals for either situation can be set. The time unit can be set to 10ms, 100ms or 1s increments.	19 Byte	6.7
One Shot [OS]		The One Shot Function Block awaits a signal supplied to the input pin thereafter setting the output according to the specified time. The timing parameters control the state of the output (depending on the priority setting). The time unit can be set to 10ms, 100ms or 1s increments.	17 Byte	6.8
Flicker [FL]		The Flicker Function Block changes the ON and OFF state of the output according to a preset flicker time. The time unit can be set to 10ms, 100ms or 1s increments.	19 Byte	6.9
Time Switch [TS]		The Time Switch Function Block uses a predefined time schedule to control the ON and OFF status of the output.	*2	6.10
Time Switch m [TSm]		The Time Switch maintenance Function Block uses a predefined time schedule to control the ON and OFF status of the output. The function block can be setup from the TopMenu "Parameter" via the front panel keys.	*2	6.10

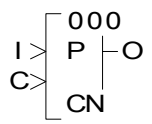
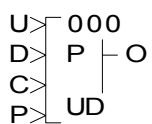
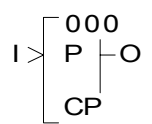
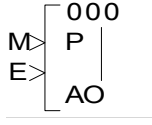
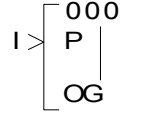
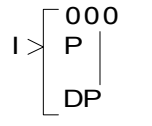
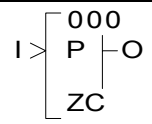
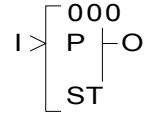
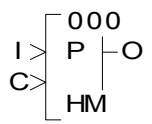
FB Name	FB Symbol	Description of Function Block	Memory Use	Section
Counter [CN]		The Counter Function Block increments the current value by one as and when the input pin receives a signal. When the current value reaches the set value the output is set ON. The counter current value is reset as and when the clear pin receives an input.	16 Byte	6.11
U/D Counter [UD]		The Up/Down Function block positively or negatively increments the counter until a set value is reached thereby setting the output ON. A preset signal can also equal the set value regardless of the current value for the function block and thereby setting the output ON.	22 Byte	6.12
Compare [CP]		The Compare Function Block monitors the current value of the input pin in relation to a preset expression. The expression consists of =,>,>=,<,<= or <>. If the compared value satisfies the expression subsequently the output pin is set on.	17 Byte	6.13
Analog Output [AO]		The Analog Output function takes a digital value input and delivers a corresponding analog voltage or current to a selected channel on the AL2-2DA module.	17 Byte	6.14
Offset Gain [OG]		The Offset Gain Function Block is based upon a linear function $Y=A/B*X+C$ to which the value obtained from an analog input (X:A01-A08) is set.	22Byte	6.15
Display [DP]		The Display Function Block is used as an interface between the user and the devices held within the controller. Current values, timer messages, user-defined messages can be read.	*4	6.16
Zone Compare [ZC]		The Zone Compare Function Block identifies whether the input value lies within a specified upper and lower limited zonal area and if so changes the status of the output accordingly.	20 Byte	6.17
Schmitt Trigger [ST]		The Schmitt Trigger Function Block compares an input value to preset high and low limits. The output is ON when the input value reaches the high limit and then falls below the lower limit. The function only processes the data when the function block is receiving an input signal.	19 Byte	6.18
Hour Meter [HM]		The Hour Meter Function Block holds the output status ON for a maximum of 32767 hours, 59 minutes and 59 seconds. If the input pin is turned OFF the elapsed time will hold its value until either the clear pin resets the time or the input pin is turned ON again.	19 Byte	6.19

FB Name	FB Symbol	Description of Function Block	Memory Use	Section
Speed Detect [SPD]	<p>The symbol shows three input lines labeled I, U, and C on the left. A vertical line labeled P is connected to the top input line. A vertical line labeled O is connected to the middle input line. A vertical line labeled SPD is connected to the bottom input line.</p>	The Speed Detect Function Block is used to count the incoming pulses max. 20Hz (with an extension module max. of 1kHz) for a set period of time. The upper and lower limits can be set from -32768 to +32767 and the Period interval's set range is 1 to 32767 in 10ms increments.	25 Byte	6.20
PWM [PWM]	<p>The symbol shows one input line labeled I on the left. A vertical line labeled P is connected to the input line. A vertical line labeled O is connected to the output line. A vertical line labeled PWM is connected to the output line.</p>	The Pulse Width Modulation Function Block changes the output status according to a set period of time with a minimum of 100ms and a maximum of 3276700ms in increments of 100ms. The percentage duty for the function controls the amount of elapsed time before the output status is changed.	16 Byte	6.21
PID	<p>The symbol shows three input lines labeled E, A, and C on the left. A vertical line labeled P is connected to the top input line. A vertical line labeled O is connected to the middle input line. A vertical line labeled PID is connected to the bottom input line.</p>	The PID Function Block is the α2 implementation of PID, a control method used to obtain stable control over a system variable. It is equipped with an Auto-tuning function, which automatically adjusts the Function Block parameters for the specific application.	52 Byte	6.22
Retentive Alternate [RAL]	<p>The symbol shows two input lines labeled I and C on the left. A vertical line labeled O is connected to the top input line. A vertical line labeled RAL is connected to the bottom input line.</p>	The Alternate Function Block is used to reverse the ON and OFF state of the output as and when the input pin receives a signal. The output will be set ON when the input pin goes high and remain ON until the input receives the second rising edge. When the power is turned OFF the function block will use the last alternation operation to control the output.	13 Byte	6.23
Addition [ADD]	<p>The symbol shows one input line labeled I on the left. A vertical line labeled P is connected to the input line. A vertical line labeled O is connected to the output line. A vertical line labeled ADD is connected to the output line.</p>	The ADD Function Block is used to summate two input values	20 Byte	6.24
Subtraction [SUB]	<p>The symbol shows one input line labeled I on the left. A vertical line labeled P is connected to the input line. A vertical line labeled O is connected to the output line. A vertical line labeled SUB is connected to the output line.</p>	The SUB Function Block is used to subtract two input values.	20 Byte	6.25
Multiplication [MUL]	<p>The symbol shows one input line labeled I on the left. A vertical line labeled P is connected to the input line. A vertical line labeled O is connected to the output line. A vertical line labeled MUL is connected to the output line.</p>	The MUL Function Block is used to multiply two input values.	20 Byte	6.26
Division [DIV]	<p>The symbol shows one input line labeled I on the left. A vertical line labeled P is connected to the input line. A vertical line labeled O is connected to the output line. A vertical line labeled DIV is connected to the output line.</p>	The DIV Function Block is used to divide two input values.	20 Byte	6.27
Calculation [CAL]	<p>The symbol shows one input line labeled I on the left. A vertical line labeled P is connected to the input line. A vertical line labeled O is connected to the output line. A vertical line labeled CAL is connected to the output line.</p>	The CAL Function Block is used to perform a calculation from the combination of different Arithmetic function blocks.	*3	6.28



FB Name	FB Symbol	Description of Function Block	Memory Use	Section
Shift [SFT]		This Shift Function Block is used to transfer the Shift Input status just before the Input signal is set ON. It has a bit input pin, a shift input pin, a set input pin, a reset input pin and a bit output pin.	19 Byte	6.29
SMS [SMS]		The GSM SMS Function Block sends the LCD screen as a SMS message to either a mobile phone handset or an E-mail account for remote maintenance purposes.	*6	6.30
Short Message Receiving [SMR]		The Short Message Receive Function Block searches for the occurrence of a command in the SM. In case the command text is exactly included in the SM, outputs are changed.	*7	6.31
Short Message Receiving m [SMRm]		The Short Message Receive maintenance Function Block searches for the occurrence of a command in the SM. In case the command text is exactly included in the SM, outputs are changed. The function block can be setup from the TopMenu "Parameter" via the front panel keys.	*7	6.31
Call Detect [CD]		The Call Detect Function Block in case the numbers of digits of both phone numbers and the phone numbers itself are equal, the CD Function Block output is switched on.	30 Byte	6.32
Call Detect m [CDm]		The Call Detect Function Block in case the numbers of digits of both phone numbers and the phone numbers itself are equal, the CD Function Block output is switched on. The function block can be setup from the TopMenu "Parameter" via the front panel keys.	30 Byte	6.32
Random One Shot [ROS]		The Random One Shot Function Block emits a random length single pulse to the output.	19 Byte	6.33
Delayed One Shot [DOS]		The Delayed One Shot Function Block emits a single pulse after a controlled delay to the output.	20 Byte	6.34
Delayed Alternate [DAL]		The Delayed Alternate Function Block alternates the status of the output with each pulse after a controlled delay.	16 Byte	6.35
Retentive Set/Reset [RSR]		The Set/Reset Function Block either holds an output ON (set) or releases the output OFF (reset.) Priority can be given to either input pin if both inputs have been energised. The default priority setting is dedicated to the reset input pin. When the power is turned OFF the function block will use the last set or reset operation to control the output.	14 Byte	6.36

FB Name	FB Symbol	Description of Function Block	Memory Use	Section
Control Display [CDP]		The Control Display Function allows the user to control the LCD image screens. The function block can only be set in AL-PCS/WIN-E software for α2 Series Controllers. When control bit N04 is ON, it is possible to control the displayed User Screen.	*5	6.37
Connect [_B]		The Connect function block is an internal device used to show the memory used by input bits, system bits, AS-interface bits, and the operation keys. No function block appears on screen or is shown as being used in the "Memory Configuration Usage" dialog box. The purpose is only to calculate the memory that is used by the bits listed above.	10 Btye	6.38
System Outputs		Control for external devices through relays and transistors.	10 Btye	-

Note:

- 1 ) Number of bytes used = 19 + 1 \* (Characters in equation)
- 2 ) Number of bytes used = 8 + 4 \* (Number of time switches)
- 3 ) Number of bytes used = 30 + 1 \* (Characters in equation)
- 4 ) Number of bytes used is decided by the displayed item.

Displayed Item		Number of bytes, α2 Series
Characters		16 + 1 × (Each character displayed)
Analog, FB value	Value	17
	Graph	23
Time, Date		14
Time Switch		17

- 5 ) Number of bytes used = 32 + 3 \* (Number of screen)
- 6 ) Number of bytes used = 12 + 1 \* (Characters in E-Mail address)
- 7 ) Number of bytes used = 37 + (Number of characters of setup commands)

## 8.5 PID Formulas

**Table 8.1: PID Equations**

Filtered Process Value	$PV_{fn} = PV_n + \alpha_f (PV_{fn-1} - PV_n)$
Filtered Set Value	$SV_{fn} = \frac{1}{T_S + \beta T_I} (T_S SV_n + \alpha \beta T_I (SV_n - SV_{n-1}) + \beta T_I SV_{fn-1})$
Deflection (Error Value)	$EV_n = PV_{fn} - SV_{fn}$
Integration Value	$I_n = \frac{T_S}{T_I} EV_n$
Derivative Value	$D_n = \frac{T_D}{T_S + K_D T_D} (PV_{fn} - 2PV_{fn-1} + PV_{fn-2} + K_D D_{n-1})$
Control Value Change in Forward Operation	$\Delta MV_n = K_P ((EV_n - EV_{n-1}) + I_n + D_n)$
Control Value Change in Reverse Operation	$\Delta MV_n = -K_P ((EV_n - EV_{n-1}) + I_n + D_n)$
Manipulation Value	$MV_n = \sum \Delta MV_n$

**Table 8.2: List of Additional Variables used in the PID equations**

Variable	Description
$EV_n$	Deflection for current sample
$EV_{n-1}$	Deflection of previous sample
$I_n$	Intergration Value for current sample
$K_D$	Derviative Gain
$K_P$	Proportional Gain
$MV_n$	Output Value for current sample (Manipulated Value)
$PV_{fn}$	Measured Value (filtered) for current sample
$PV_{fn-1}$	Measured Value (filtered) for previous sample
$PV_{fn-2}$	Measured Value (filtered) for two samples ago
$PV_n$	Measured Value for current sample
$SV_{fn}$	Set Value (filtered) for current sample
$SV_{fn-1}$	Set Value (filtered) for previous sample
$SV_n$	Set Value for current sample
$SV_{n-1}$	Set Value for previous sample
$T_D$	Dervative Time
$T_I$	Integration Time
$T_S$	Sample Time
$\Delta MV_n$	Change in Manipulated Value for the current sample
$\alpha$	Proportional gain coefficient (See Control Response)
$\alpha_f$	Input value filter coefficient
$\beta$	Integration time coefficient (See Control Response)

**Table 8.3: Coeffiecient Values for Different Response Times**

Operation	$\alpha$	$\beta$
FAST	100%	100%
NORMAL	40%	135%
SLOW	0%	100%



# **mitsubishi electric corporation**

HEAD OFFICE : TOKYO BUILDING, 2-7-3 MARUNOUCHI, CHIYODA-KU, TOKYO 100-8310, JAPAN

---

JY992D97101G  
(MEE)

Effective April 2015  
Specifications are subject to change without notice.