

# **EMC Installation Guidelines**

**FR-A700**

**FR-A701**

**FR-F700**

**FR-E700**

**FR-D700**

**MITSUBISHI**

In this EMC Installation Guidelines, handling and precautions for compliance with the EC EMC Directive are explained. Incorrect handling might cause an unexpected fault. Before using an inverter, always read this EMC Instruction Guidelines carefully to use the equipment to its optimum performance.

This section is specifically about safety matters

Do not attempt to install, operate, maintain or inspect the inverter until you have read through the EMC Instruction Guidelines and appended documents carefully and can use the equipment correctly. Do not use this product until you have a full knowledge of the equipment, safety information and instructions.

In this EMC Installation Guidelines, the safety instruction levels are classified into "WARNING" and "CAUTION".



Incorrect handling may cause hazardous conditions, resulting in death or severe injury.



Incorrect handling may cause hazardous conditions, resulting in medium or slight injury, or may cause only material damage.

The CAUTION level may even lead to a serious consequence according to conditions. Both instruction levels must be followed because these are important to personal safety.

 CAUTION LARGE LEAKAGE CURRENT

When an EMC filter is used, leakage current flows through the EMC filter.

Ground (earth) the EMC filter before connecting the power supply to prevent an electric shock.

General instruction

Many of the diagrams and drawings in this guideline show the inverter without a cover or partially open for explanation. Never operate the inverter in this manner. The cover must be always reinstalled, and the instruction in this guideline must be followed when operating the inverter.

# Contents

1. Introduction .....	1-1
2. Compliance to the EMC Directive of the inverter .....	2-1
3. EMC measures .....	3-1
3. 1 Basics of the EMC measures.....	3-1
3. 2 Precaution for inverter mounting to the enclosure .....	3-2
3. 3 Precaution for wiring .....	3-4
3. 4 Others precautions.....	3-8
4. EMC measure options .....	4-1
4.1 EMC Directive compliant EMC filter .....	4-1
4.2 Other precautions .....	4-4
4.3 List of the EMC Directive compliant filters and their applicable inverters .....	4-7
5. EMC data .....	5-1
FR-A720.....	5-1
FR-A740.....	5-9
FR-A741.....	5-21
FR-F720.....	5-28
FR-F740.....	5-36
FR-E720.....	5-48
FR-E740.....	5-55
FR-E720S .....	5-61
FR-D720 .....	5-65
FR-D740 .....	5-70
FR-D720S .....	5-76

# 1. Introduction

This EMC Guidelines offers information on the Electromagnetic Compatibility (EMC) measures when using the Mitsubishi inverters. The following subjects are explained in this guideline.

How we interpret the EMC Directive for the use of inverters is explained in Chapter 2.

The EMC measures for using a Mitsubishi inverter is explained in Chapter 3 in detail. It includes explanations regarding enclosure specification, grounding (earthing), wiring and installation in the enclosure.

Model names and specifications of the EMC measure options, which are explained in Chapter 3, are explained in Chapter 4.

The EMC data collected by Mitsubishi is explained in Chapter 5.

Follow this EMC Guidelines when similar explanation regarding EMC measures exists in an Inverter Instruction Manual.

## ●List of applicable inverters

FR-A700 series	FR-A720
	FR-A740
FR-A701 series	FR-A741
FR-F700 series	FR-F720
	FR-F740
FR-E700 series	FR-E720
	FR-E740
	FR-E720S
FR-D700 series	FR-D720
	FR-D740
	FR-D720S

## 2. Compliance to the EMC Directive of the inverter

A general-purpose inverter is not designed to operate by itself, but is a component designed to be installed in a control enclosure in combination with other devices to operate a machine or equipment.

Many organizations including the European Committee of Manufacturers of Electrical Machines and Power Electronics (CEMEP) interpreted that components were not directly subject to the EMC Directive under the EMC Directive (89/336/EEC).

However, under the amended EMC Directive (2004/108/EC), components are required to conform with the EMC Directive.

Mitsubishi performs assessment on major models for the conformity with the EMC Directive under the conditions described in this guideline and declares that the models conform with the EMC Directive (2004/108/EC). Mitsubishi cannot, however, declare the conformity of an inverter in your operating conditions. EMC changes by the enclosure structure that contains the inverter, compatibility with other embedded electronic devices, wiring, and placement. For this reason, ensure that the entire machine or the system conforms with the EMC Directive.

Installation methods and EMC measure options are recommended in this guideline so that the machine or the system that is containing an inverter can conform with the EMC Directive easier. (To comply with the EMC Directive in the environment described in Chapter 5, the installation method and the EMC measure option, which are explained in Chapter 5, must be used.)

### <Supplementary information>

#### ● EC Directives and CE marking

The EC Directives are issued by the Council of the European Union to standardize different national regulations of the EU Member States and to facilitate free movement of the equipment whose safety is ensured. CE marking (affixation of the CE marking) is required to distribute the products subject to the EC Directives in the EU territory.

When the manufacturer or his authorized representative does not comply with these requirements, (1) a fine, (2) withdrawal from the market, and (3) prohibition of the free movement of the product are imposed.

#### ● EMC Directive (89/336/EEC)

The EMC Directive is one of the EC Directives. The EMC Directive requires products not to generate excessive electromagnetic disturbance to outside (emission or electromagnetic interference) and to have immunity to the external electromagnetic disturbance from outside (immunity or electromagnetic susceptibility). The applicable products are required to bear CE marking.

Affixation of the CE marking on the products, which conform with the EMC Directive, has been required since January 1, 1996. It was repealed on July 20, 2007, and it will be prohibited to market a product in compliant with the provisions of this EMC Directive after July 20, 2009.

●EMC Directive (2004/108/EC)

The new Directive was issued on December 15, 2004 by reviewing the provisions in the EMC Directive (89/336/EEC) issued on May 3, 1998. The new Directive has been effective since July 20, 2007. Main changes from the EMC Directive (89/336/EEC) are the following.

- (1) Defining the applicable scope (exclusion of fixed installation)
- (2) Simplifying the method to declare conformity (Self-declaration due to the discontinuation of declaration through the Competent Body.)
- (3) Reinforcing the submission of traceability information
- (4) Obligating the production of technical documentation
- (5) Reinforcing the market monitoring

●European Standards (EN)

To affix CE marking on a product as defined in the EC Directives, the product must conform with the applicable regulation of the European Standards, and appropriate measures must be taken to ensure the safety of the product.

The European Standards was constituted to remove trade barriers for the people, goods, capital and service in Europe, which had received increased interest since the EC market integration in 1992. European Standards are harmonized standards that tries to standardize different standards, codes and assessment system.

The following European Standard applies to the EMC Directive for the adjustable speed electrical power drive system including an inverter.

EN61800-3:EMC requirements and specific test methods

Mitsubishi inverter is capable of conforming with the Second environment/Restricted distribution of above standard by practicing the EMC measures stated on the following pages. (Refer to page 1-1 for the applicable inverters.)

## ● Declaration of conformity and technical documentation

### Declaration of conformity

To affix CE marking on a product, the "technical documentation," which states that the product conforms with the EMC Directive, is required. In most cases, the manufacturer, which declares the conformity, is not required to submit the declaration to a third party, and only required to hold the declaration. However, when discontinuing production of a product, the manufacturer or the authorized representative in the EU must hold the declaration of conformity and the technical documentation for at least ten years after the date the product was last manufactured.

### Technical documentation

The manufacturer or the authorized representative in the EU of the applied product is required to draw up technical documentation stating that the product is being produced with conformance and to hold the technical documentation. In this technical documentation, EMC assessment data and condition as well as the technical explanation for the EMC are included. The technical documentation must be updated so that it can be submitted to the EU authorities when requested.

### 3. EMC measures

#### 3.1 Basics of the EMC measures

EMC (Electromagnetic compatibility) means both emissions and immunity as shown below.

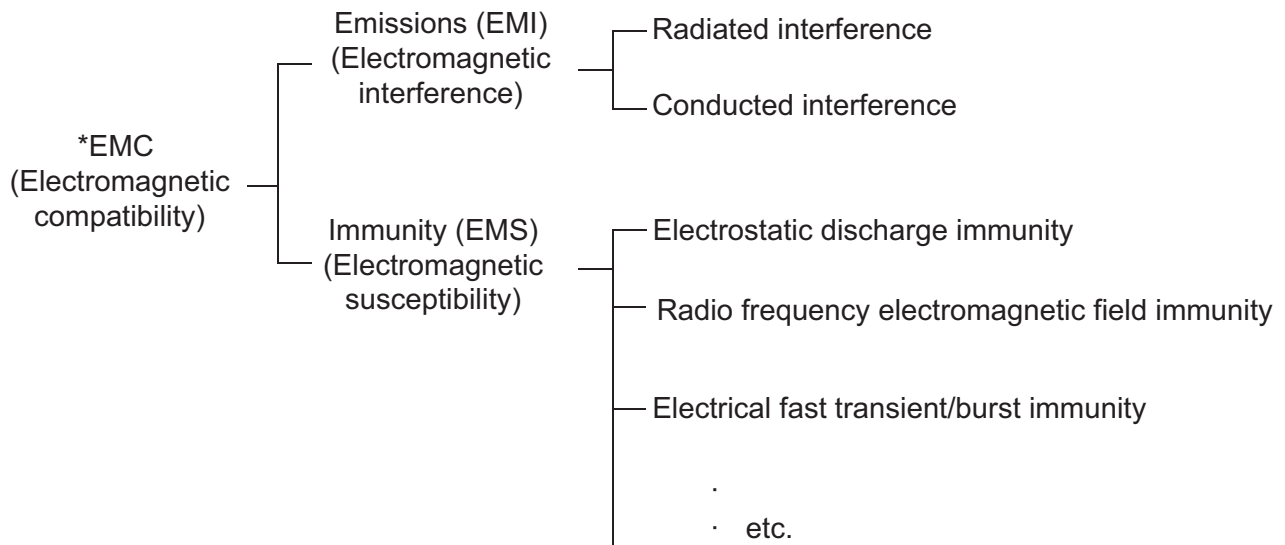

Note \* EMC is a capability of a device or a system to operate as commanded without receiving or giving influence of electromagnetic field and without performance loss or fault when the device or the system starts the operation at the commanded position.

The measures described in this guideline are primarily intended to control emissions, but they are also effective in increasing immunity.

Various EMC measures exist, but main measures are the following. EMC measures become effective by applying the following measures.

- (1) Install equipment in a closed metal enclosure. (Keep the radiant interference inside.)
- (2) Use an EMC filter (Reduce conducted interference.)
- (3) Ground (earth) securely (Avoid causing antenna effect.)
- (4) Shield the power cable and the control cable. (Keep the radiant interference inside.)
- (5) Keep the equipment away from the interference source, or install the interference source in a separate enclosure. (Keep the radiant interference inside.)
- (6) Isolate the circuits. (Cut the conducted interference.)
- (7) Change the inverter parameter settings. (Reduces generated interference and disturbance effect)

EMC measures are explained in detail on the following pages.



### 3. 2 Precaution for inverter mounting to the enclosure

Enclosure design and layout are important points for controlling EMC. Perform installation by considering the following points.

- (1) Use a metal enclosure.
- (2) Use EMI gasket or other conductive packing to where the enclosure door touches the enclosure body. Using a short thick rectangular wire to connect the door to the body is another effective measure.

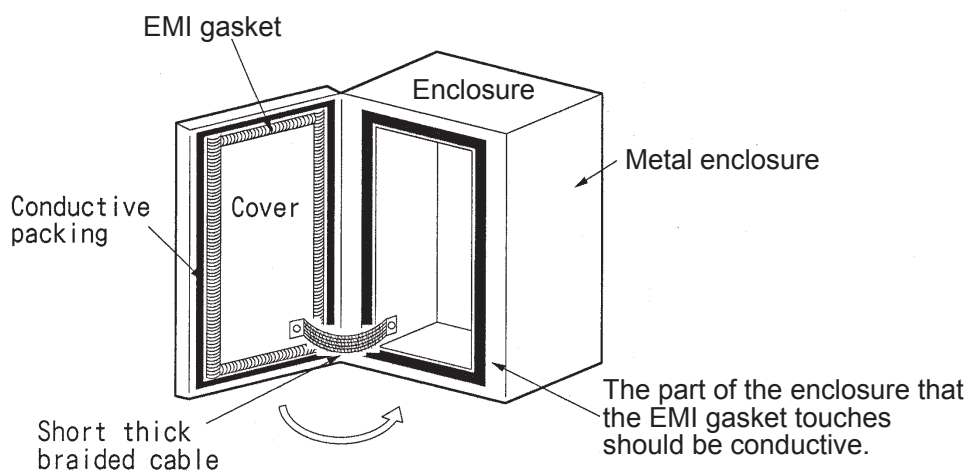

- (3) It is recommended to use the inverter with the EMC filter, which is already embedded or available as an option. When using an option EMC filter, mask the painting or plate the area of the enclosure where the EMC filter is mounted so that the electrical connection can be established between the EMC filter and the ground (earth) of the enclosure. Confirm that the EMC filter is securely fitted to the enclosure surface. Confirm that the equipment mounting board inside the enclosure is also connected to the ground (earth).

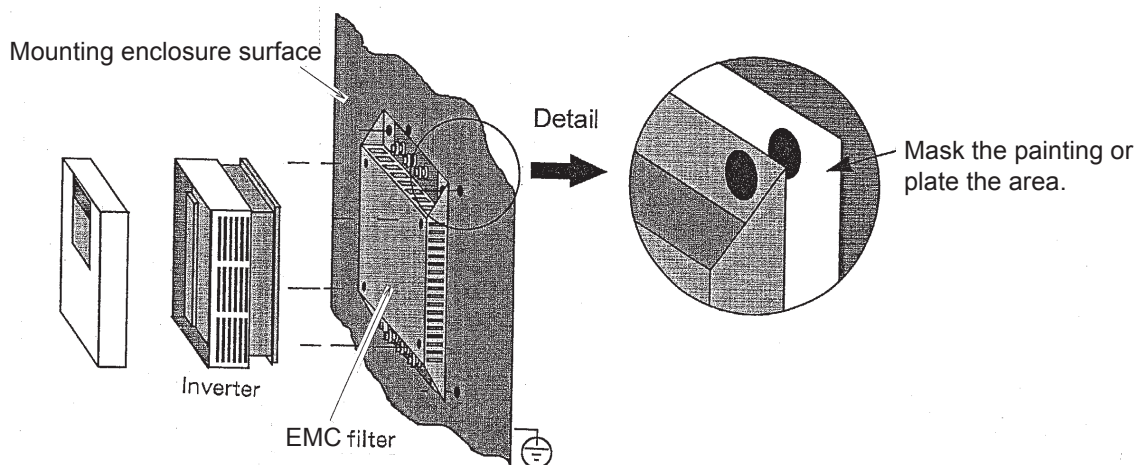

- (4) Weld or screw the main board, side boards and such without leaving space. The space between each connecting section (welding section or screws) should be less than 10cm. If the space exists between boards, the shielding effect may be lost. The dimension of holes in the enclosure, such as ventilation holes, should be less than 10cm. Holes larger than that should be covered with metal board or punching metal. When using these material, ensure not to loose the electric connection by using anti-conductive material or material. One faulty example of this is a connection between painted areas.

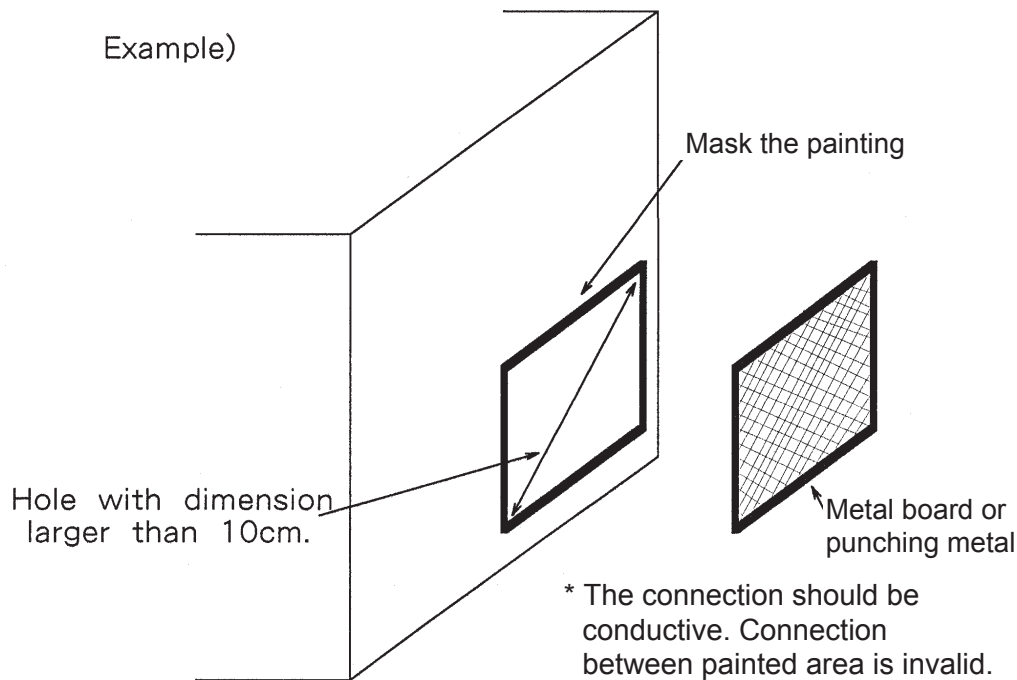

- (5) Use a thick short wire to connect the earth terminal of the control device to the earth terminal of the enclosure.
- (6) Use a thick short wire to ground (earth) the enclosure.
- (7) Using separate enclosures for the driving device including an inverter and for the signal controlling device provide more effective EMC measure.

### 3. 3 Precaution for wiring

The power cable and the control cable of an inverter can act as antennas to radiated interference, and on the contrary, they can radiate interference to outside, so the appropriate measures must be taken. Especially, the cable between the inverter and the motor can be a strong interference source. Perform wiring by considering the following points.

- (1) For the power cable, use a shielded cable or use metal conduit to shield the cable.
- (2) When connecting the shield or the metal conduit of the power cable to the enclosure, use a P-clip or U-clip to ground (earth) as close as possible. P-clip or U-clip should be placed within 10cm from the enclosure as a reference.
- (3) The cable between the inverter and the EMC filter should be 50cm or less.

#### ●Example of a cable gland

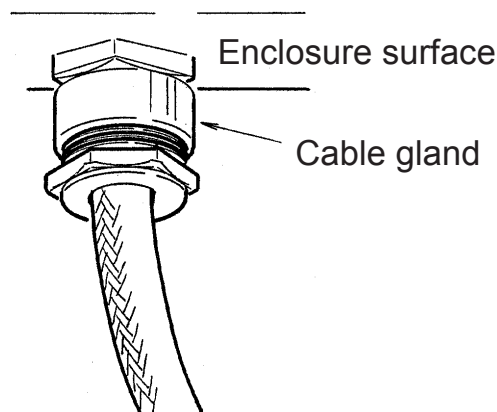

#### ●Example of P-clip and U-clip

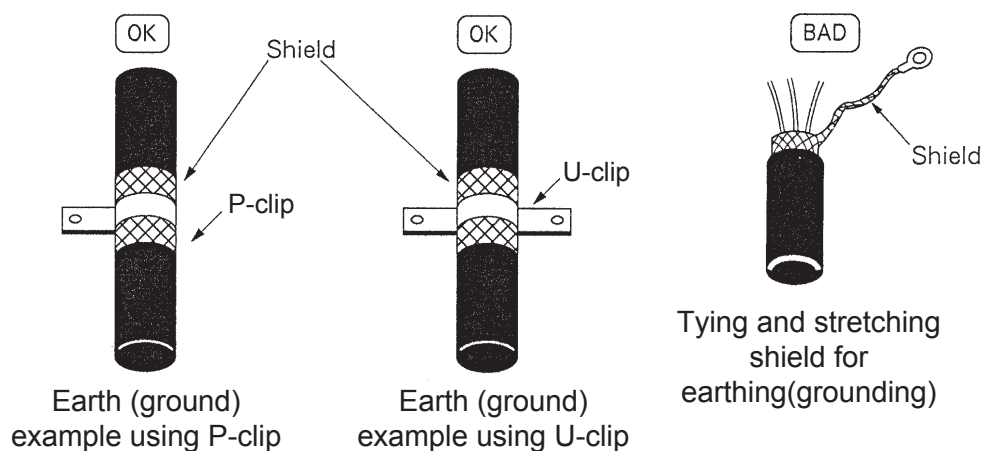

● Recommended shield grounding (earthing)

When using a cable gland

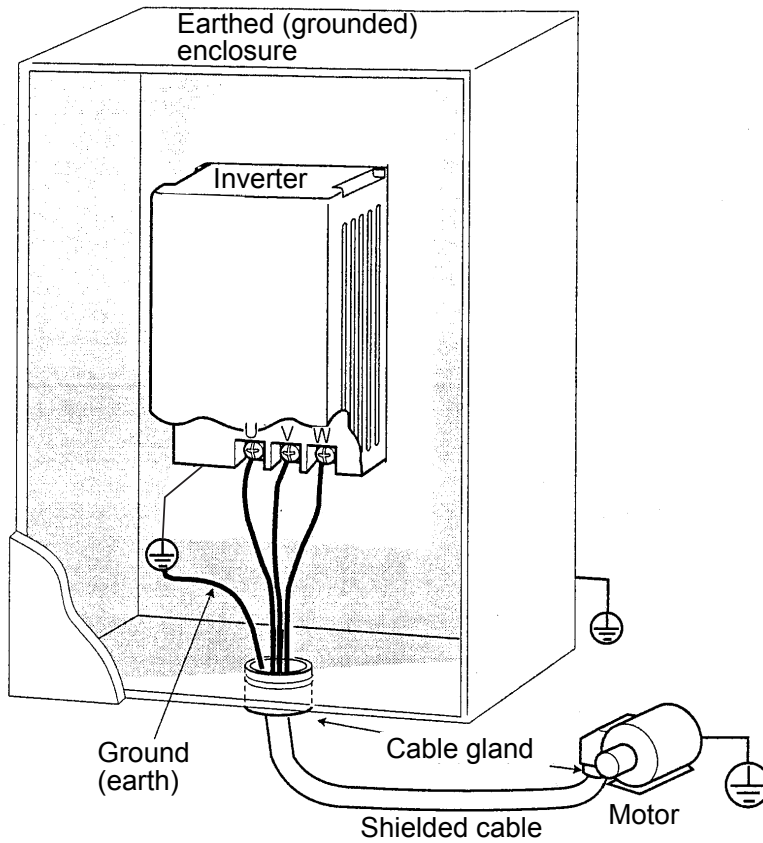

When using an U-clip

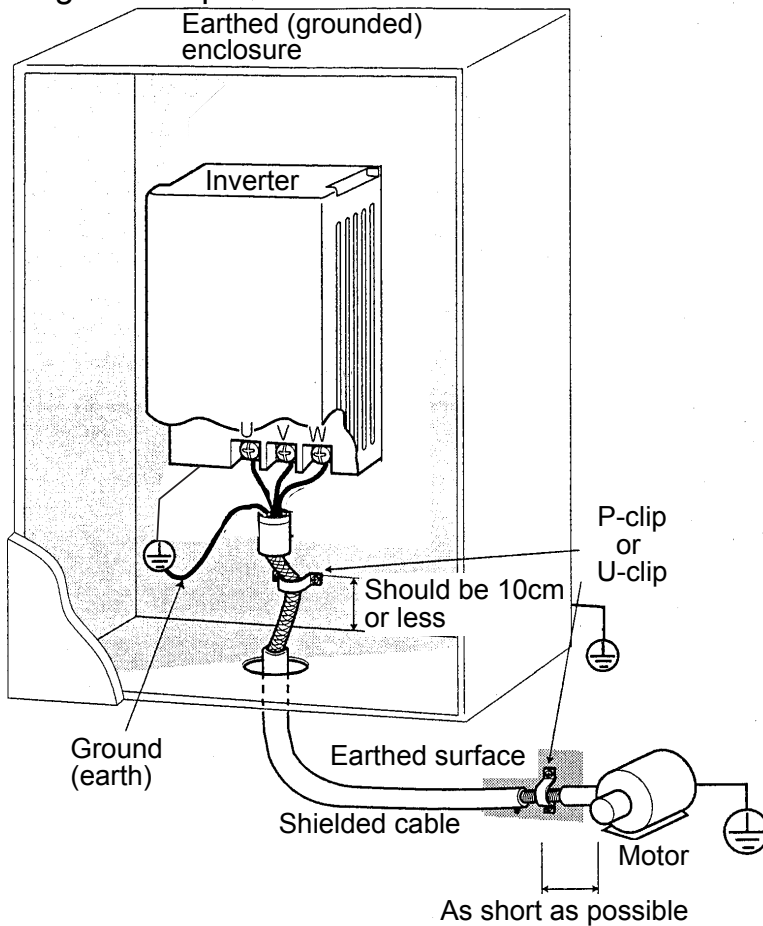

● Unfavorable shield grounding (earthing)

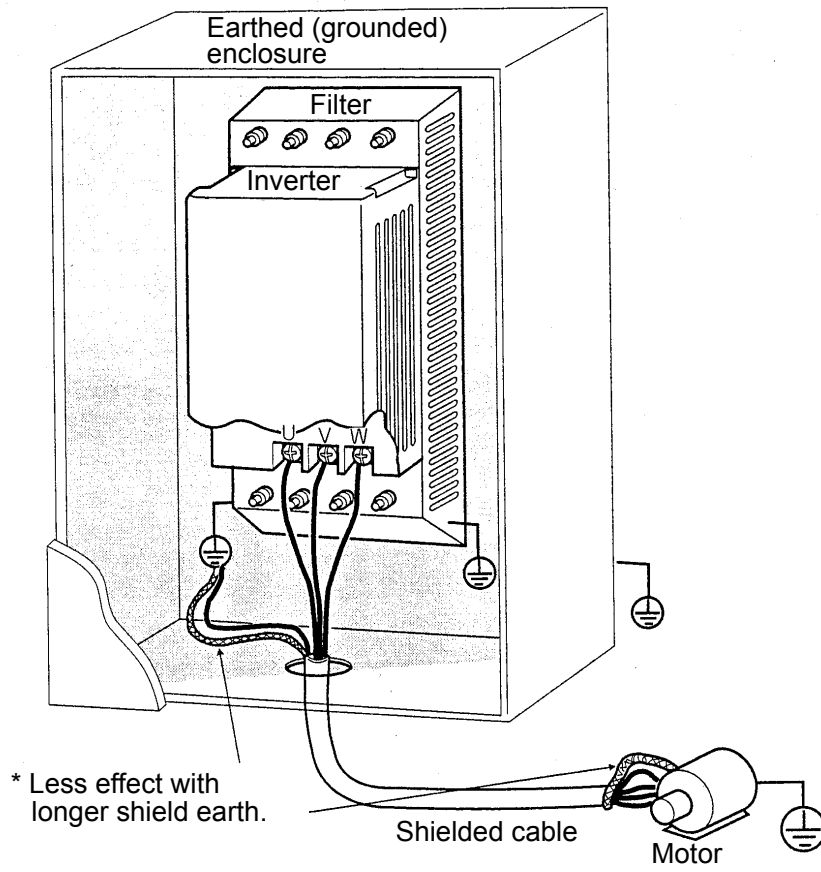

- (4) Separate the power cable from the control signal cable, and input side of the power cable from the output side. Separate them by at least 10cm. (30cm or more is recommended.)
- (5) Route the control cables inside the enclosure. If a control cable extends outside the enclosure, use a shielded cable, and connect the earth shield to the control terminal common and do not ground (earth) it. If required, use a ferrite core that is commercially available. The ferrite core should be installed within 10cm from the equipment.

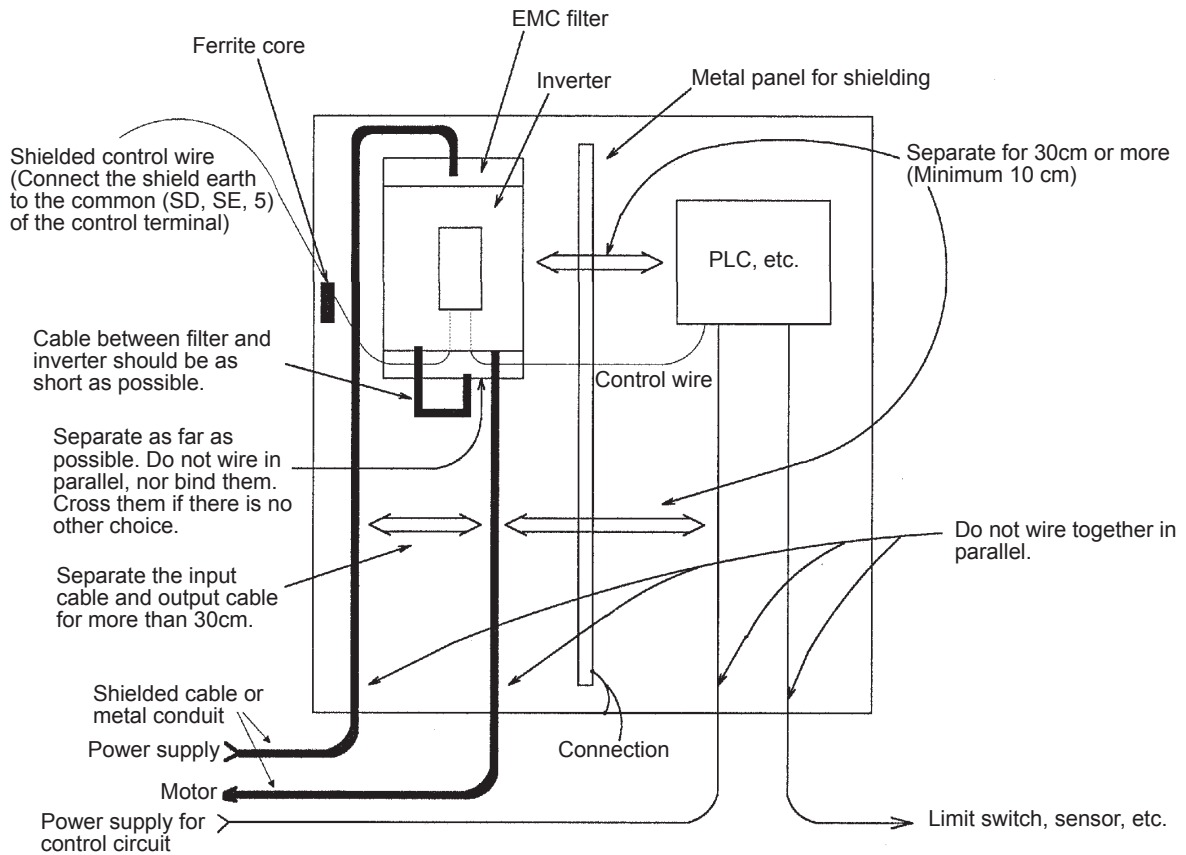

- (6) Inserting the line noise filter FR-BLF or FR-BSF01, which is described in Chapter 4, into the input or output side of the inverter improves the interference reduction effect.

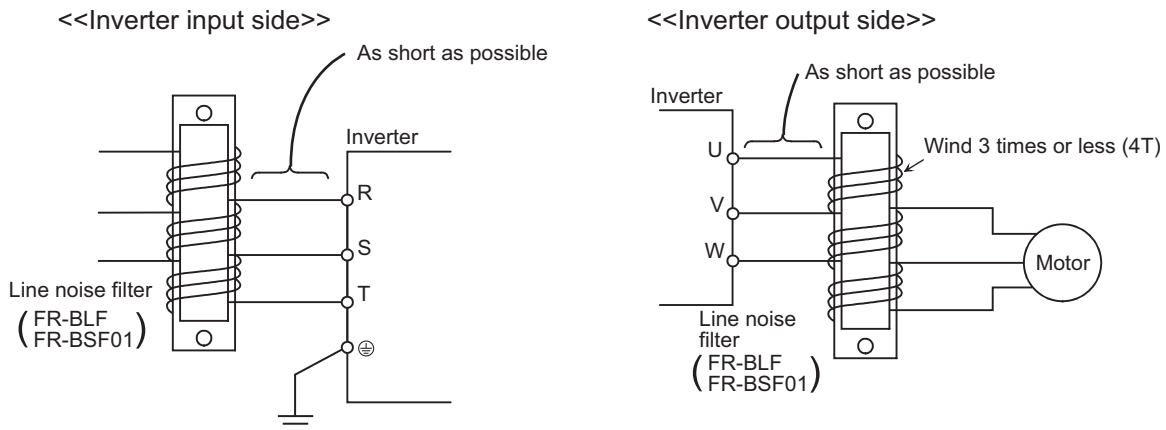

- (7) Ensure to ground (earth) at the motor side.

### 3. 4 Others precautions

- (1) Set the PWM frequency (Pr.72) low by the parameter setting.  
Some models allow their PWM frequencies to be set lower. Doing this can reduce the interference generated from the inverter, but increases the acoustic noise generated from the motor.
  
- (2) Increase the input filter time constant (Pr.74) of the inverter by the parameter setting.  
(Immunity measure)  
Some models allow their filter time constant settings, which are used for the frequency setting signal input, to be changed. The frequency setting signals are given by external voltage or current input. Set this filter time constant higher if the operation is unstable because of the interference. Note that setting this value higher will make the inverter response slow.

## 4. EMC measure options

The following options are available for the EMC measures.

### 4.1 EMC Directive compliant EMC filter

The EMC Directive compliant EMC filter is recommended to be used to conform with the EMC Directive.

(1) Pre-installation check

- (a) Check the rating plate on the EMC filter and ensure that the model and the rating meets your order.
- (b) Check that the EMC filter has not been damaged during transportation.

(2) Rating plate on the filter

Rating plate is located next to the terminal block or on the side of the EMC filter.

Example of the rating plate next to the terminals

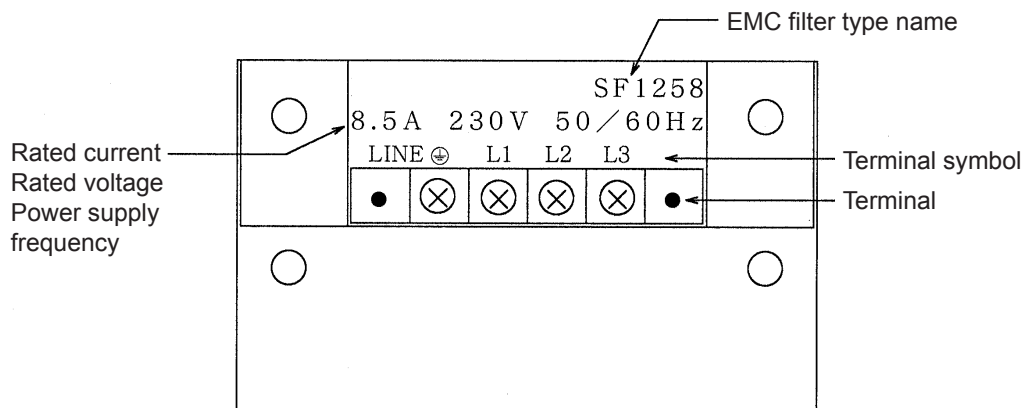

Example of the rating plate on the side or the front of the EMC filter

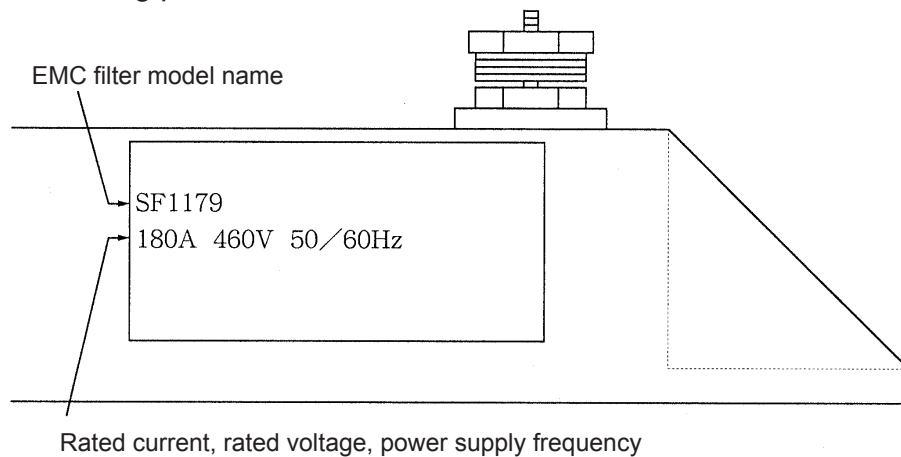

(3) Model name

SF□□□□□: Model name consists of SF and four or five digits characters after SF.



(4) Precaution for handling

(a) Mounting

This EMC filter is designed to be mounted to the back of an inverter. Place an inverter to the EMC filter as shown below and fix it securely with screws. Then, securely fix the EMC filter to the enclosure using the screws and the installation holes of the EMC filter.

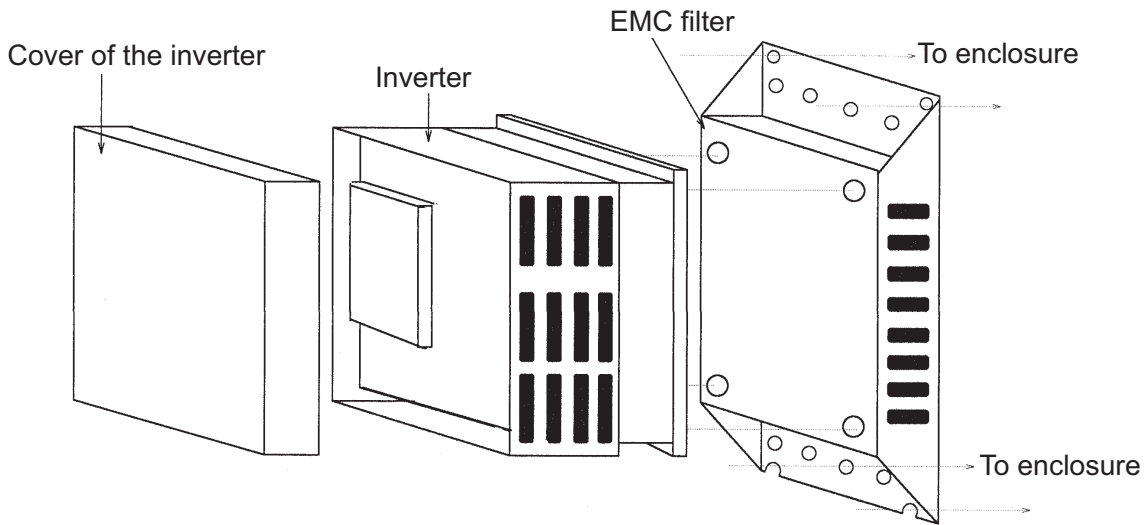

(b) Wiring and connection

Check the filter terminal symbols, and connect as shown in the figure below.

[Example of three-phase input model]

[Example of single-phase input model]

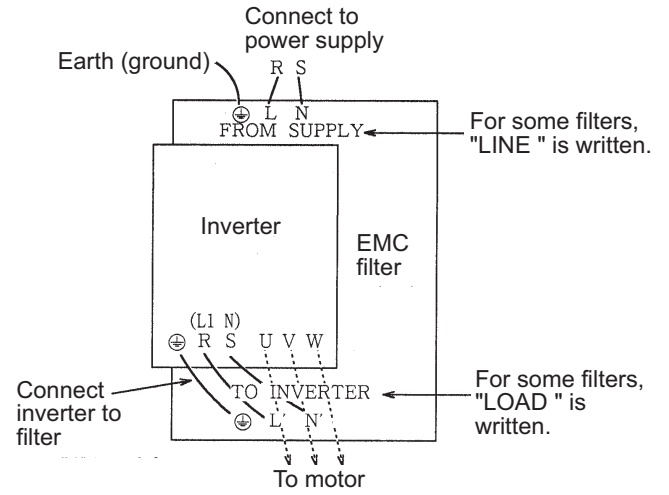
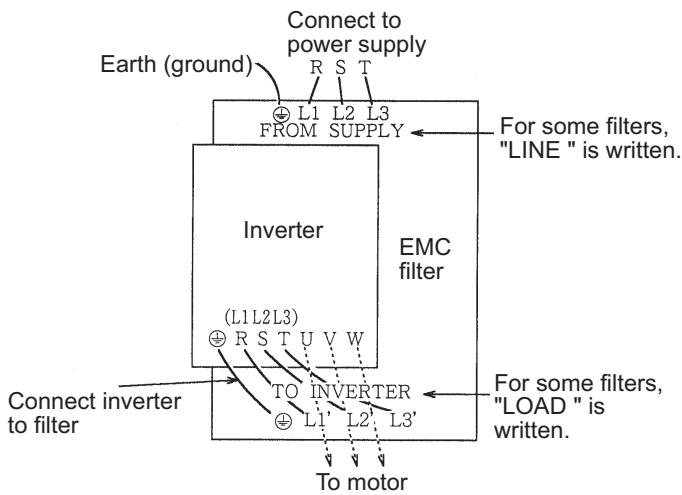

(c) Wiring diagram

[Example of three-phase input model]

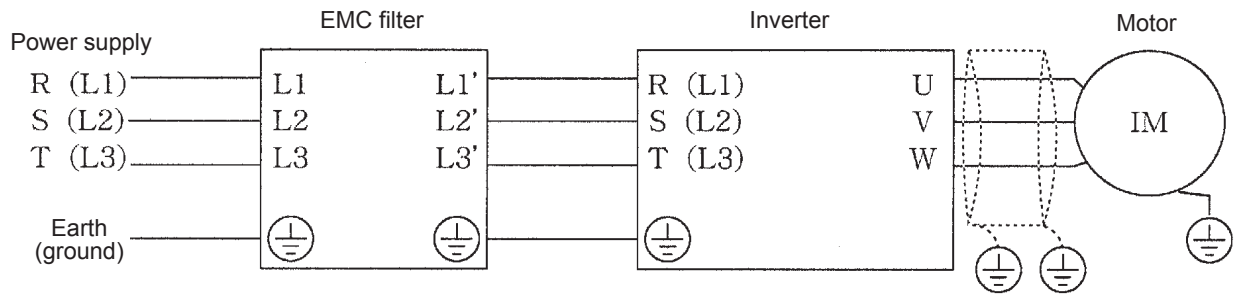

[Example of single-phase input model]

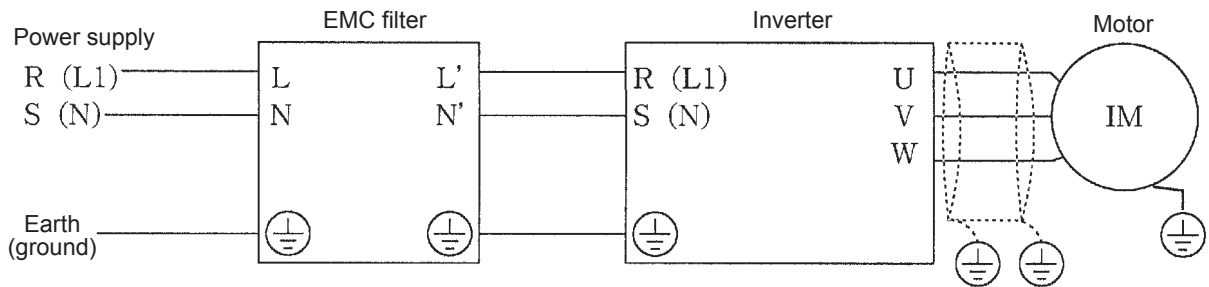

(5) Environment

Surrounding air temperature	-10°C to +50°C
Ambient humidity	90%RH or less (non-condensing)
Storage temperature	-20°C to +50°C
Atmosphere	Indoors (free from corrosive gas, flammable gas, oil mist, dust and dirt)
Altitude / vibration	Maximum 1,000m above sea level / Maximum 0.6G

## 4.2 Other precautions

### Leakage current

EMC filter reduces conductive interference to the power supply when it is inserted to the power line of the inverter. The internal circuit of the EMC filter consists of coils, capacitors and resistors, and these reduce conductive interference to the power supply. In this circuit, the capacitors, which are inserted between the power supply line and the ground (earth), reduce the interference but increase leakage current to the ground (earth).

- Influence of leakage current

Possible effects of leakage current are as follows.

- (a) If the EMC filter is not properly grounded (earthed), there is a chance of an electric shock.
- (b) An earth leakage circuit breaker (earth leakage circuit relay) installed on top of the EMC filter may operate unnecessarily.

- Countermeasures to the above

Take the following countermeasures to the above effects.

- (a) Connect the EMC filter to the ground (earth) before connecting the power supply. Confirm that the grounding (earthing) is securely performed through the ground (earth) of the enclosure.
- (b) Select an earth leakage circuit breaker or an earth leakage circuit relay according to the leakage current of the EMC filter. (Refer to the following for the selection method. Calculate by applying the leakage current from the EMC filter to "I<sub>gn</sub>".)

Because the leakage current of the high power filters is so large, the earth leakage circuit breaker may not be available. In that case, use a higher rated earth leakage circuit relay. If it is not possible to use either of an earth leakage circuit breaker or an earth leakage circuit relay, perform grounding (earthing) securely as shown in (a).

● Selection of rated sensitivity current of earth (ground) leakage current breaker

When using the earth leakage current breaker with the inverter circuit, select its rated sensitivity current as follows, independently of the PWM carrier frequency.

- Breaker designed for harmonic and surge suppression

$$\text{Rated sensitivity current } I_{\Delta n} \geq 10 \times (I_{g1} + I_{gn} + I_{gi} + I_{g2} + I_{gm})$$

- Standard breaker

$$\text{Rated sensitivity current } I_{\Delta n} \geq 10 \times \{I_{g1} + I_{gn} + I_{gi} + 3 \times (I_{g2} + I_{gm})\}$$

$I_{g1}, I_{g2}$ : Leakage currents in wire path during commercial power supply operation

$I_{gn}$ : Leakage current of the inverter input side EMC filter

$I_{gm}$ : Leakage current of motor during commercial power supply operation

$I_{gi}$ : Leakage current of inverter unit

Example of leakage current of cable path per 1km during the commercial power supply operation when the CV cable is routed in metal conduit (200V 60Hz)

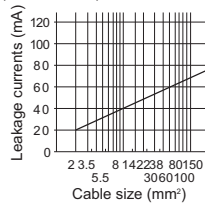

Leakage current example of three-phase induction motor during the commercial power supply operation (200V 60Hz)

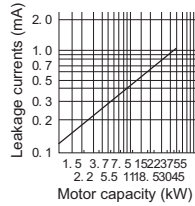

Example of leakage current per 1km during the commercial power supply operation when the CV cable is routed in metal conduit (Three-phase three-wire delta connection 400V60Hz)

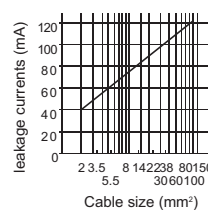

Leakage current example of three-phase induction motor during the commercial power supply operation (Totally-enclosed fan-cooled type motor 400V60Hz)

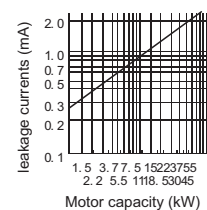

For "Δ" connection, the amount of leakage current is approx. 1/3 of the above value.

(Example)

Selection example for FR-A700 series and FR-F700 series

(mA)

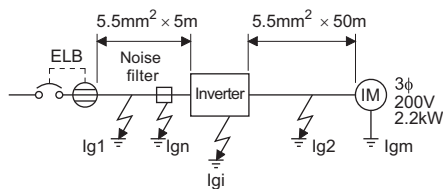

	Breaker Designed for Harmonic and Surge Suppression	Standard Breaker
Leakage current $I_{g1}$	$33 \times \frac{5m}{1000m} = 0.17$	
Leakage current $I_{gn}$	0 (without noise filter)	
Leakage current $I_{gi}$	22 (with EMC filter ON)	
Leakage current $I_{g2}$	$33 \times \frac{50m}{1000m} = 1.65$	
Motor leakage current $I_{gm}$	0.18	
Total leakage current	24	27.66
Rated sensitivity current ( $\geq I_g \times 10$ )	500	500

• Inverter leakage current (with and without EMC filter)

Input power conditions

(200V class: 220V/60Hz, 400V class: 440V/60Hz, power supply unbalance within 3%)

	Voltage (V)	EMC filter	
		ON (mA)	OFF (mA)
Phase grounding	200	22 (1)*	1
	400	30	1
Earthed-neutral system	400	1	1

\* For the FR-A720-0.4K, 0.75K and FR-F720-0.75K, 1.5K, the EMC filter is always valid. The leakage current is 1mA.

Selection example for FR-E700 series and FR-D700 series

(mA)

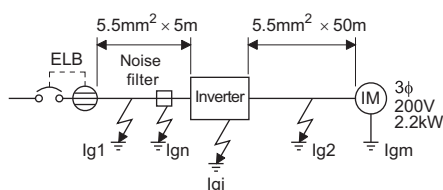

	Breaker Designed for Harmonic and Surge Suppression	Standard Breaker
Leakage current $I_{g1}$	$33 \times \frac{5m}{1000m} = 0.17$	
Leakage current $I_{gn}$	15 (with noise filter SF1309)	
Leakage current $I_{gi}$	1	
Leakage current $I_{g2}$	$33 \times \frac{50m}{1000m} = 1.65$	
Motor leakage current $I_{gm}$	0.18	
Total leakage current	18	21.66
Rated sensitivity current ( $\geq I_g \times 10$ )	200	500

Note

- Install the earth leakage breaker (ELB) on the input side of the inverter.
- In the Y connection earthed-neutral system, the sensitivity current is blunt against an earth (ground) fault in the inverter output side. Earthing (Grounding) must conform to the requirements of national and local safety regulations and electrical codes. (NEC section 250, IEC 536 class 1 and other applicable standards)
- When the breaker is installed on the output side of the inverter, it may be unnecessarily operated by harmonics even if the effective value is less than the rating. In this case, do not install the breaker since the eddy current and hysteresis loss will increase, leading to temperature rise.
- The following models are standard breakers....BV-C1, BC-V, NVB, NV-L, NV-G2N, NV-G3NA and NV-2F earth leakage relay (except NV-ZHA), NV with AA neutral wire open-phase protection  
The other models are designed for harmonic and surge suppression....NV-C/NV-S/MN series, NV30-FA, NV50-FA, BV-C2, earth leakage alarm breaker (NF-Z), NV-ZHA, NV-H

## 4.3 List of the EMC Directive compliant filters and their applicable inverters

### ●FR-A701 series

EMC filter model name	Applicable inverter model name	Outline dimension (Unit: mm)				Mass (kg)	Leakage current (mA) * (reference value)
		W	H	D	D1		
SF1174B	FR-A741-5.5K, 7.5K	213	360	38	-	1.8	51
SF1175	FR-A741-11K, 15K	253	530	60	25	4.7	76
SF1176	FR-A741-18.5K, 22K	303	600	60	29	5.9	108
SF1177	FR-A741-30K	327	700	80	29	9.4	156
SF1178	FR-A741-37K, 45K	450	770	80	36	16	156
SF1179	FR-A741-55K	467	920	80	36	19	156

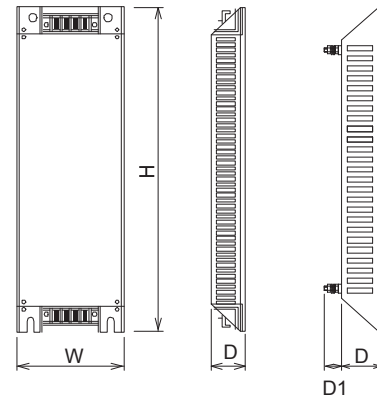

\* The leakage current indicated is equivalent to one-phase of cable for the three-phase three-wire star connection. For a three-phase, three-wire, delta-connection power supply, the value is about three times greater than the indicated.  
(Note) Outline dimension drawing shown is one of a typical model. The shape differs according to each model.

### ●FR-E700 series

EMC filter model name	Applicable inverter model name	Intercompatibility attachment*1	Outline dimension (Unit: mm)			Mass (kg)	Leakage current (mA) *2 (reference value)	Loss (W)
			W	H	D			
SF1306	FR-E720-0.1K to 1.5K	-	110	200	36.5	0.7	10	7.3
SF1309	FR-E720-2.2K, 3.7K	FR-E5T	200	282	57	2.1	15	15
	FR-E720S-2.2K	FR-E7AT03						
SF1320	FR-E720S-0.1K to 0.4K	-	70	168	30.5	0.4	10	2.7
SF1321	FR-E720S-0.75K	-	110	168	36.5	0.6	10	3.8
FR-E5NF-H0.75K	FR-E740-0.4K, 0.75K	-	140	210	46	1.1	22.6	5.5
FR-E5NF-H3.7K	FR-E740-1.5K to 3.7K	-	140	210	46	1.2	44.5	8
FR-E5NF-H7.5K	FR-E740-5.5K, 7.5K	-	220	210	47	2	68.4	15
FR-S5NFSA-1.5K	FR-E720S-1.5K	-	110	168	35	0.7	9.5	8.55

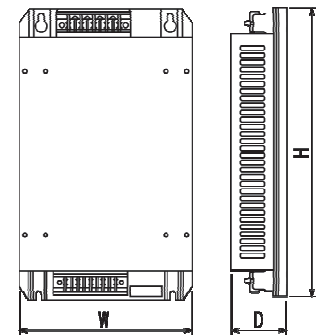

EMC filter model name	Applicable inverter model name	Intercompatibility attachment*1	Outline dimension (Unit: mm)				Mass (kg)	Leakage current (mA) *2 (reference value)	Loss (W)
			W	H	D	D1			
SF1260	FR-E720-5.5K, 7.5K	FR-E5T-02	222	468	80	29	5	440	118
	FR-E720-11K	FR-A5AT03							
SF1261	FR-E720-15K	FR-AAT02	253	600	86	28.5	9.3	71	37
SF1175	FR-E740-11K, 15K	FR-AAT02	253	530	60	25	4.7	76	56

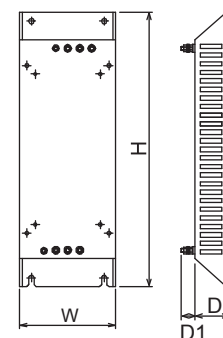

\*1 When the intercompatibility attachment is mounted, the depth will increase by 12mm.

\*2 The leakage current indicated is equivalent to one-phase of cable for the three-phase three-wire star connection. For a three-phase, three-wire, delta-connection power supply, the value is about three times greater than the indicated.  
(Note) Outline dimension drawing shown is one of a typical model. The shape differs according to each model.

●FR-D700 series

EMC filter model name	Applicable inverter model name	Intercompatibility attachment*1	Outline dimension (Unit: mm)			Mass (kg)	Leakage current (mA) *2 (reference value)	Loss (W)
			W	H	D			
SF1306	FR-D720-0.1K to 1.5K	-	110	200	36.5	0.7	10	7.3
SF1309	FR-D720-2.2K, 3.7K	FR-E5T	200	282	57	2.1	15	15
	FR-D720S-2.2K	FR-E7AT03						
FR-E5NF-H0.75K	FR-D740-0.4K, 0.75K	-	140	210	46	1.1	22.6	5.5
FR-E5NF-H3.7K	FR-D740-1.5K to 3.7K	-	140	210	46	1.2	44.5	8
FR-E5NF-H7.5K	FR-D740-5.5K, 7.5K	-	220	210	47	2	68.4	15
FR-S5NFSA-0.75K	FR-D720S-0.1K to 0.75K	-	70	168	35	0.5	4.5	6
FR-S5NFSA-1.5K	FR-D720S-0.1K	-	110	168	47	0.7	9.5	11

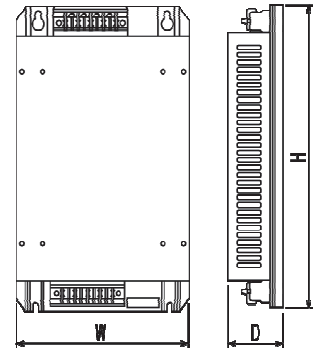

EMC filter model name	Applicable inverter model name	Intercompatibility attachment*1	Outline dimension (Unit: mm)				Mass (kg)	Leakage current (mA) *2 (reference value)	Loss (W)
			W	H	D	D1			
SF1260	FR-D720-5.5K to 11K	FR-A5AT03	222	468	80	29	5	440	118
SF1261	FR-D720-15K	FR-AAT02	253	600	86	28.5	9.3	71	37
SF1175	FR-D740-11K, 15K	FR-AAT02	253	530	60	25	4.7	76	56

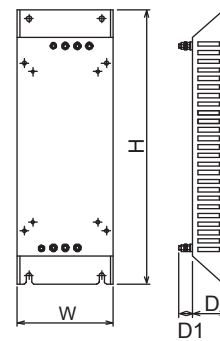

\*1 When the intercompatibility attachment is mounted, the depth will increase by 12mm.

\*2 The leakage current indicated is equivalent to one-phase of cable for the three-phase three-wire star connection. For a three-phase, three-wire, delta-connection power supply, the value is about three times greater than the indicated.  
 (Note) Outline dimension drawing shown is one of a typical model. The shape differs according to each model.

## 5. EMC data

This Chapter explains about the EMC data examples when the inverter-embedded EMC filter is used.

### FR-A720

<<Conditions>>

This inverter conforms with the product standard of EN61800-3.

Measurement was conducted according to the conditions of the product standard of EN61800-3 2<sup>nd</sup> environment.

Output wire length: 5m  
Output cable: Shielded cable  
Enclosure: No-door type

Operation frequency: 30Hz  
Carrier frequency: Refer to the each graph

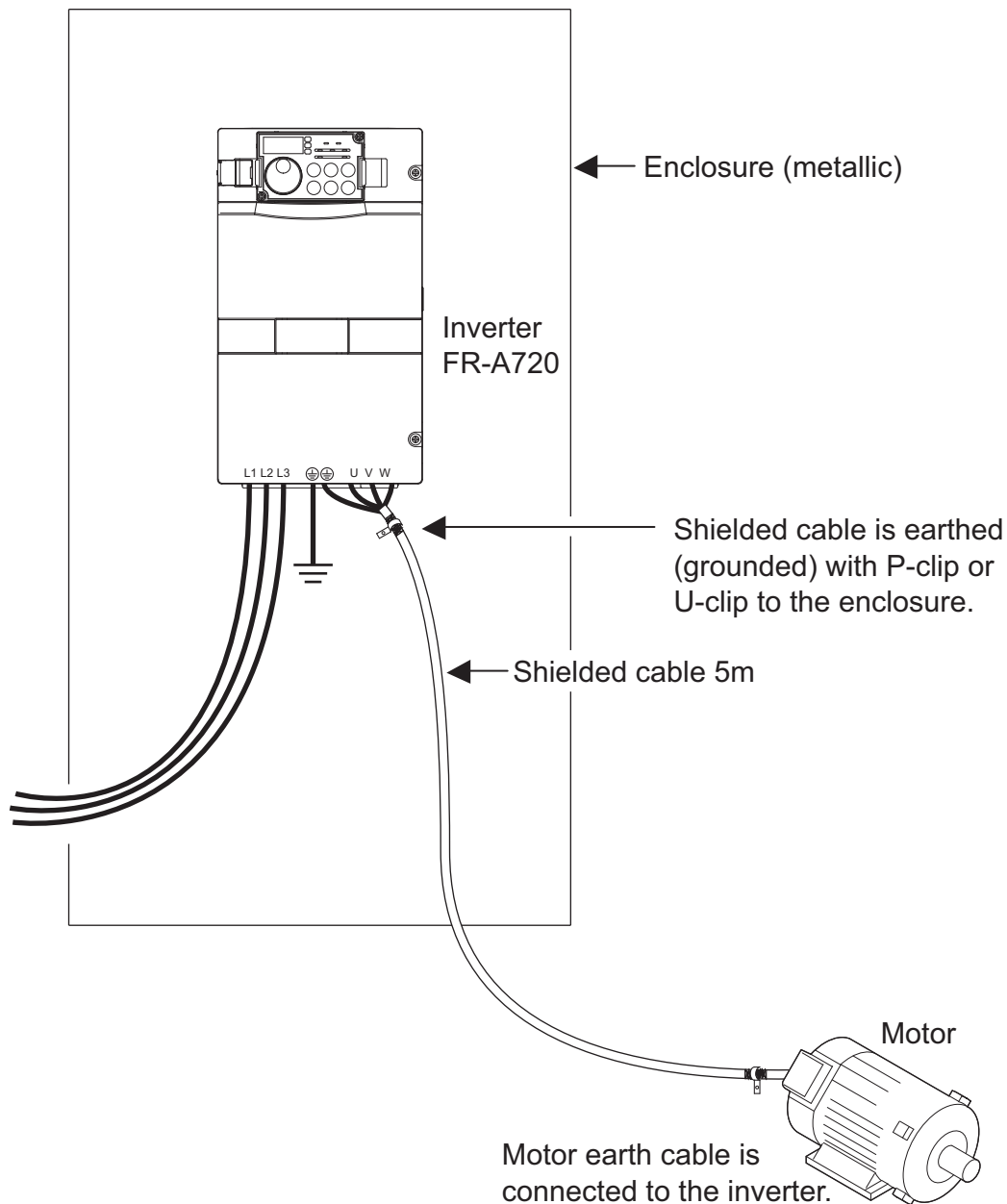



<<Measurement result>>

• FR-A720-0.75K

© Conducted interference

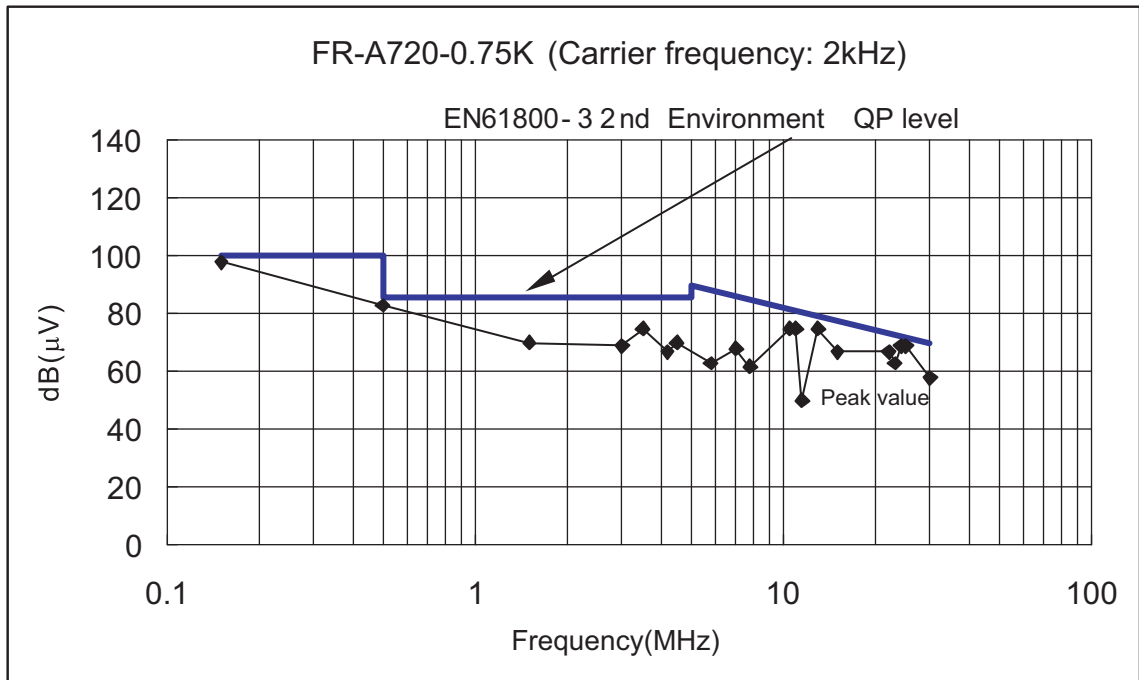

(Note) The QP value will not exceed the peak value.

© Radiated interference (10m site)

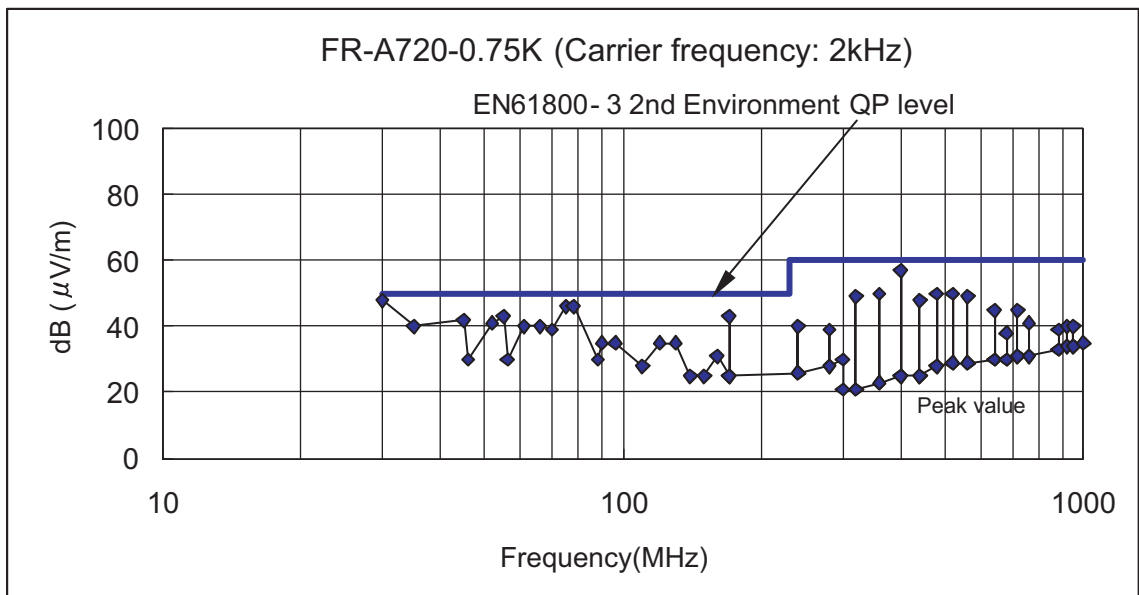

(Note) The QP value will not exceed the peak value.

• FR-A720-3.7K

◎ Conducted interference

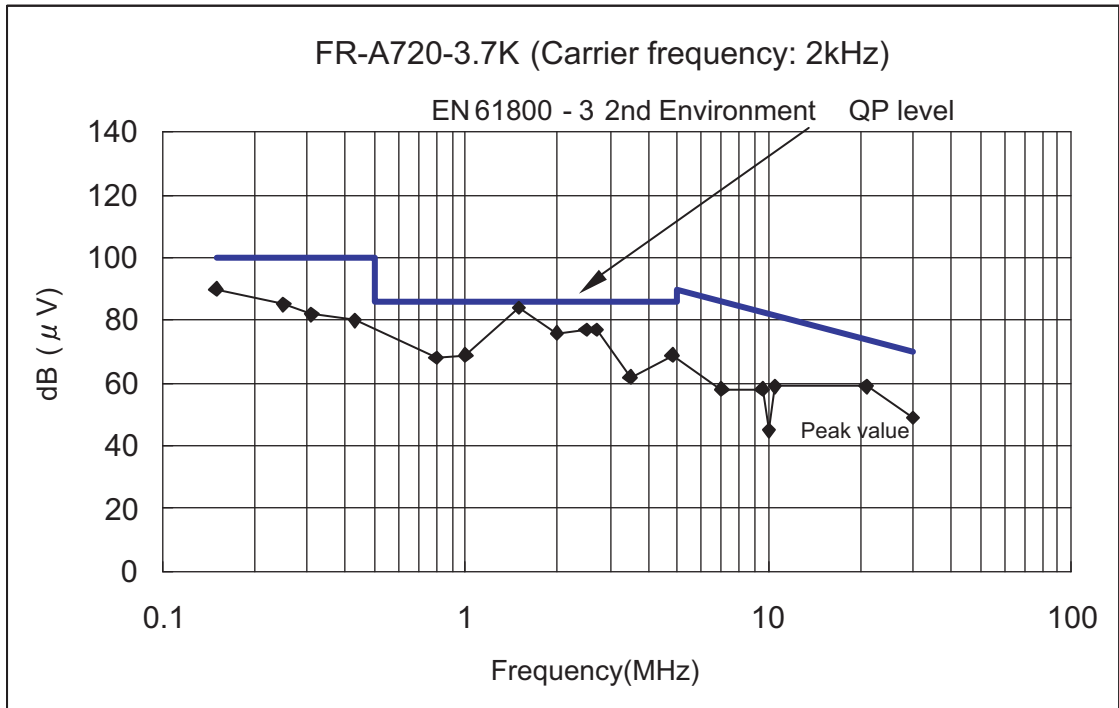

(Note) The QP value will not exceed the peak value.

◎ Radiated interference (10m site)

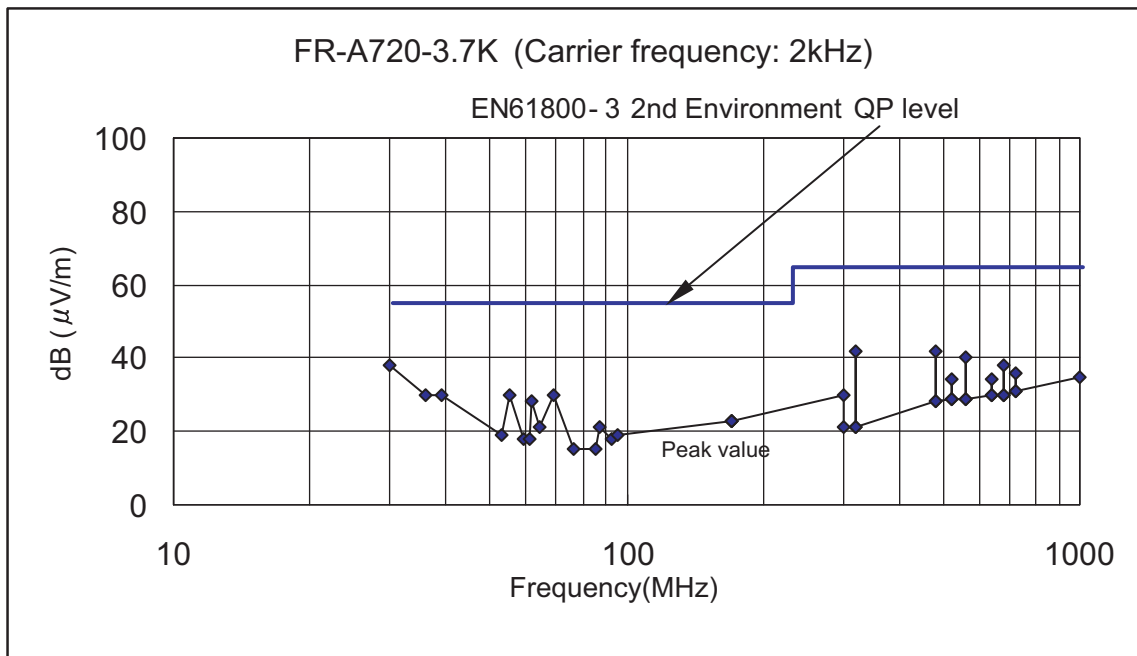

(Note) The QP value will not exceed the peak value.

• FR-A720-7.5K

© Conducted interference

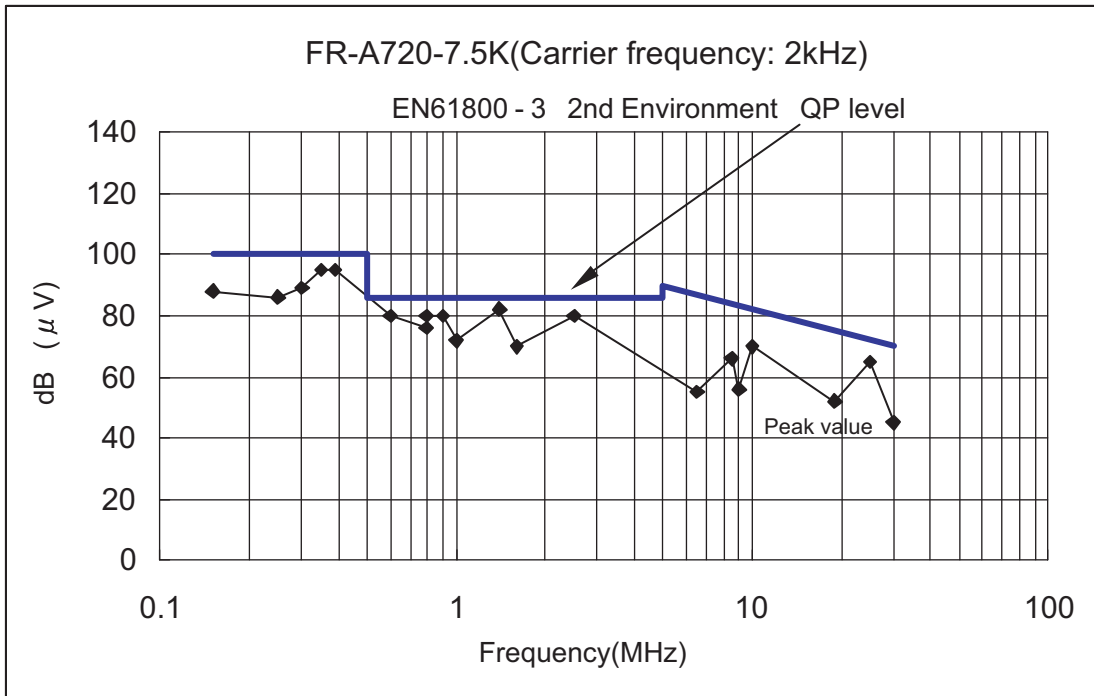

(Note) The QP value will not exceed the peak value.

© Radiated interference (10m site)

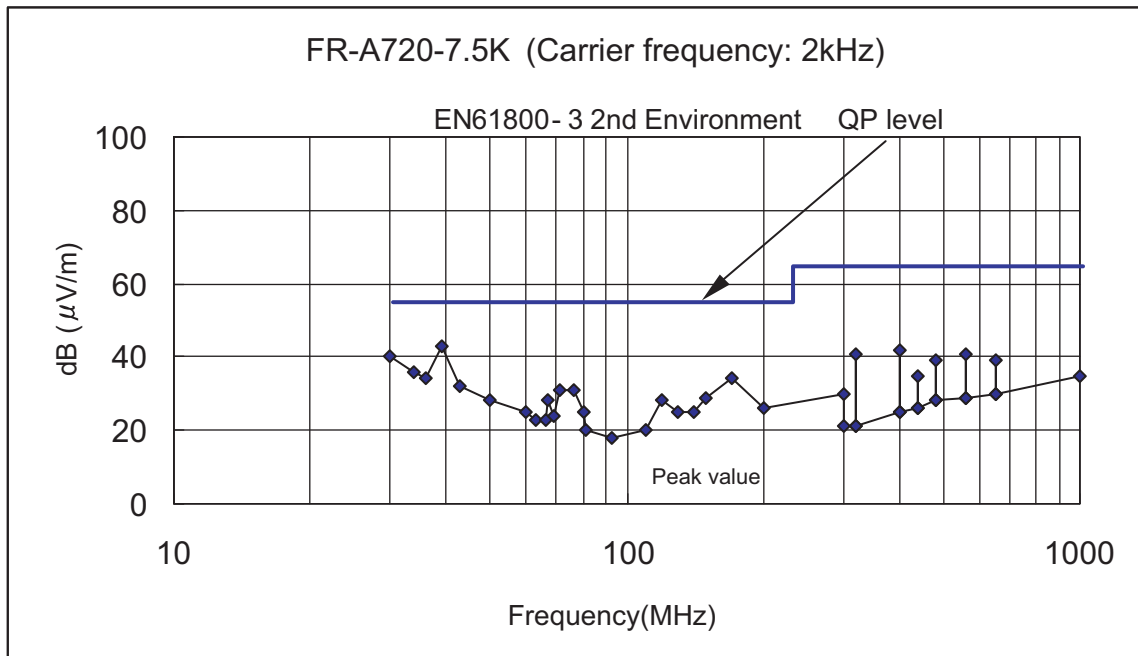

(Note) The QP value will not exceed the peak value.

• FR-A720-11K

◎ Conducted interference

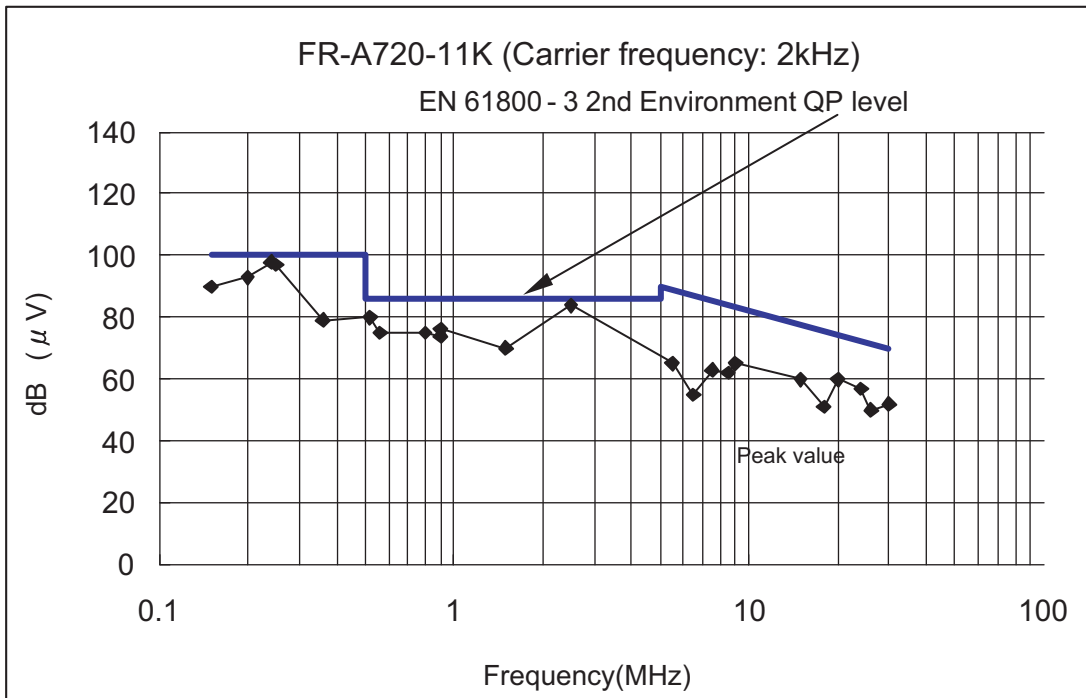

(Note) The QP value will not exceed the peak value.

◎ Radiated interference (10m site)

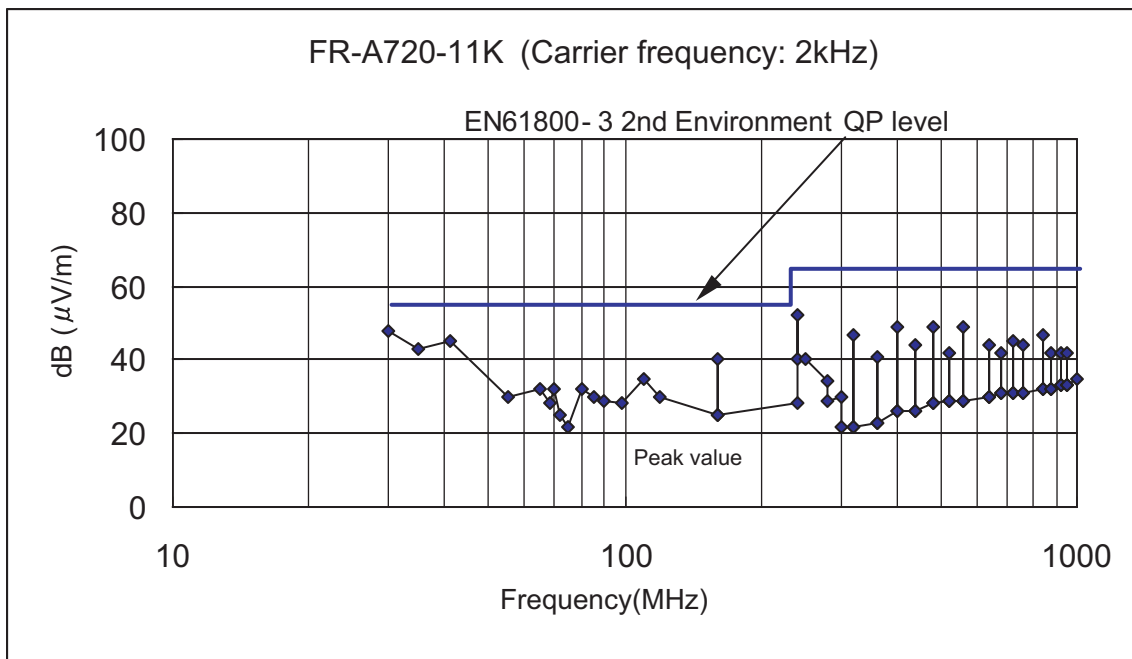

(Note) The QP value will not exceed the peak value.

• FR-A720-22K

© Conducted interference

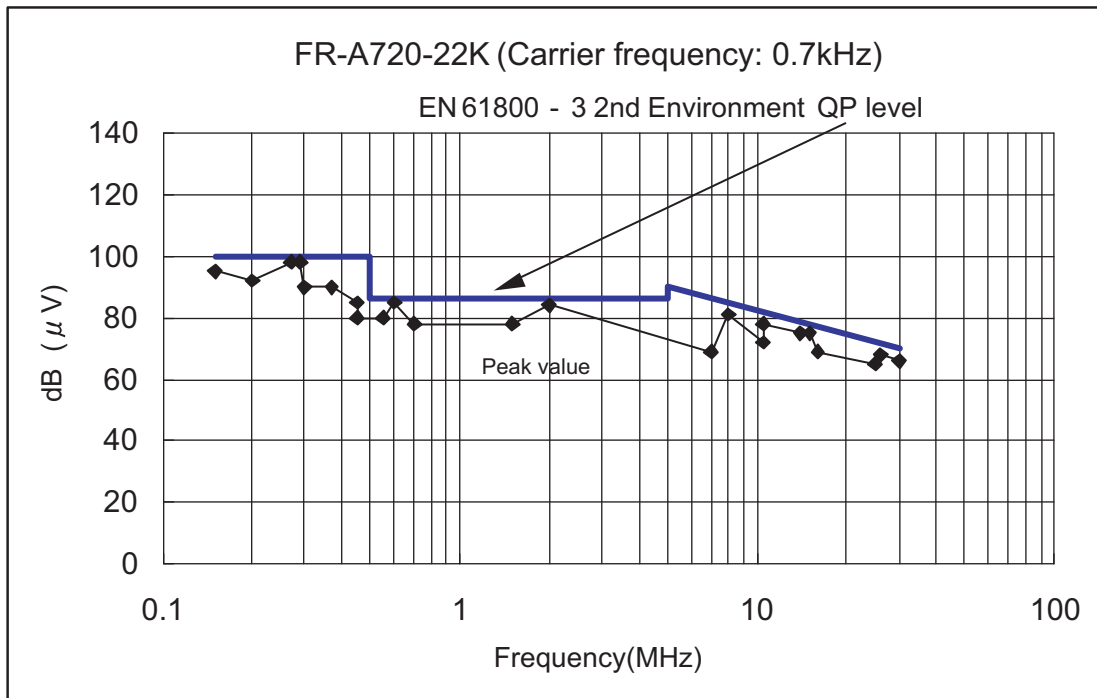

(Note) The QP value will not exceed the peak value.

© Radiated interference (10m site)

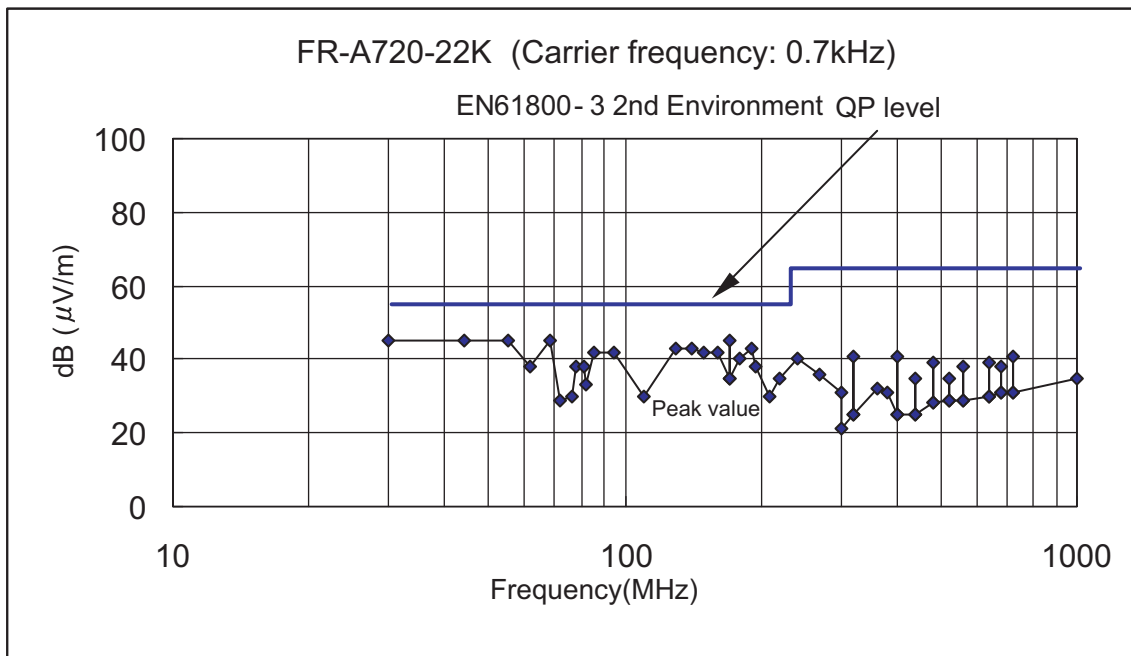

(Note) The QP value will not exceed the peak value.

The 22K model does not conform with the EN61800-3 Second Environment under Real sensorless vector control or the vector control.

• FR-A720-45K

© Conducted interference

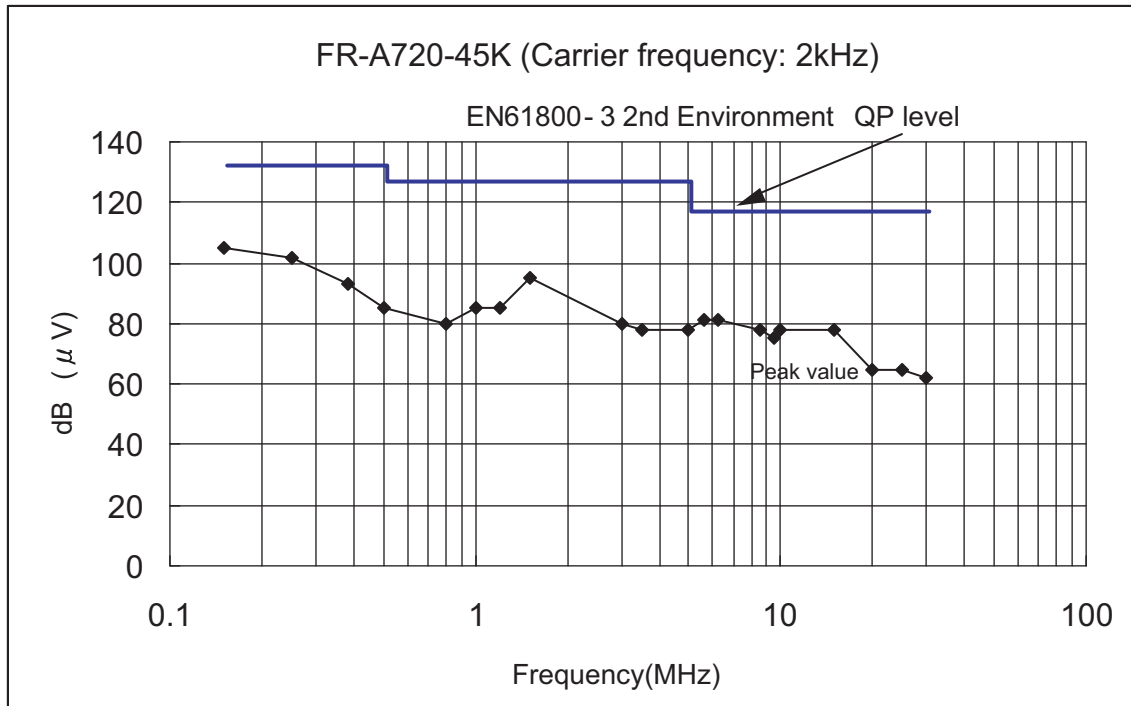

(Note) The QP value will not exceed the peak value.

© Radiated interference (10m site)

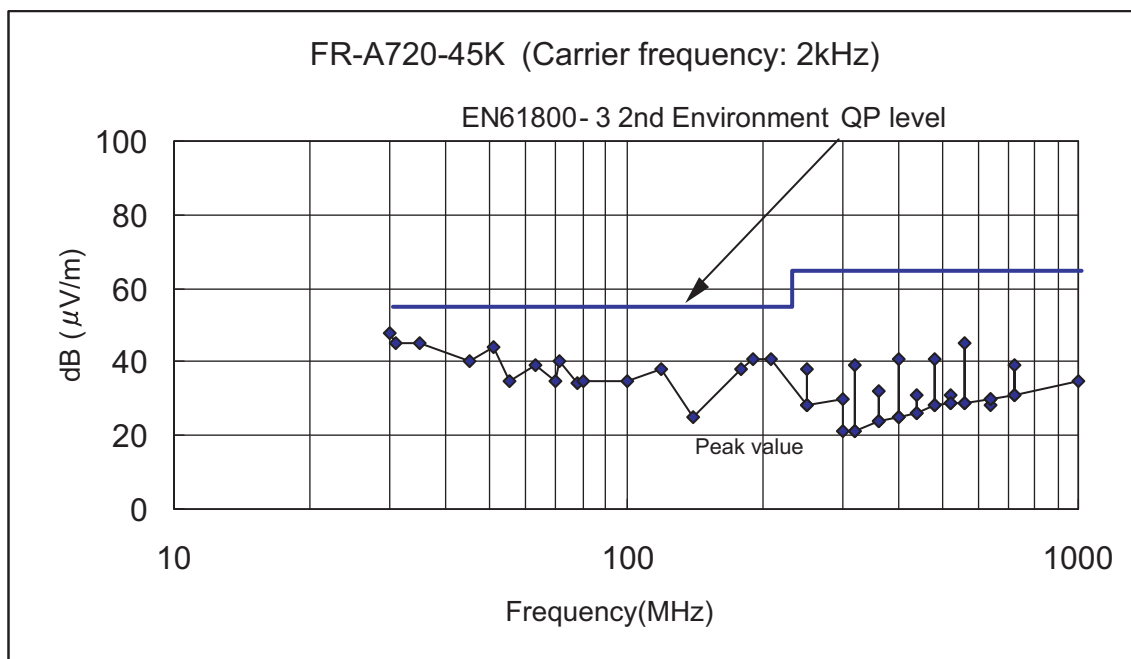

(Note) The QP value will not exceed the peak value.

• FR-A720-90K

© Conducted interference

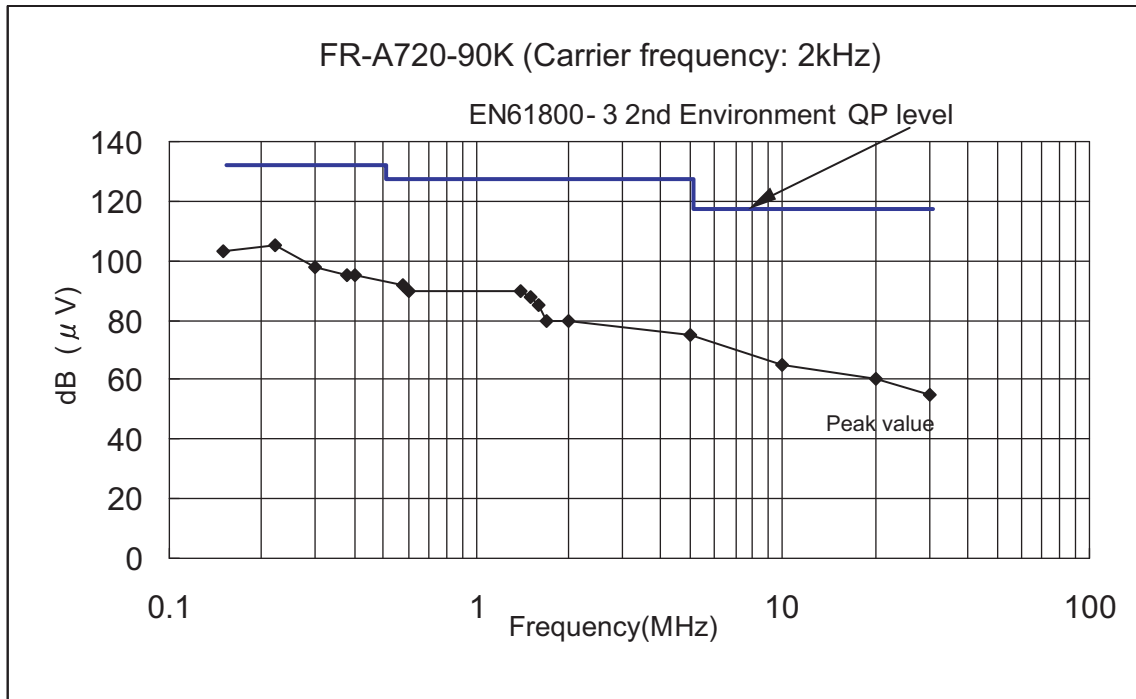

(Note) The QP value will not exceed the peak value.

© Radiated interference (10m site)

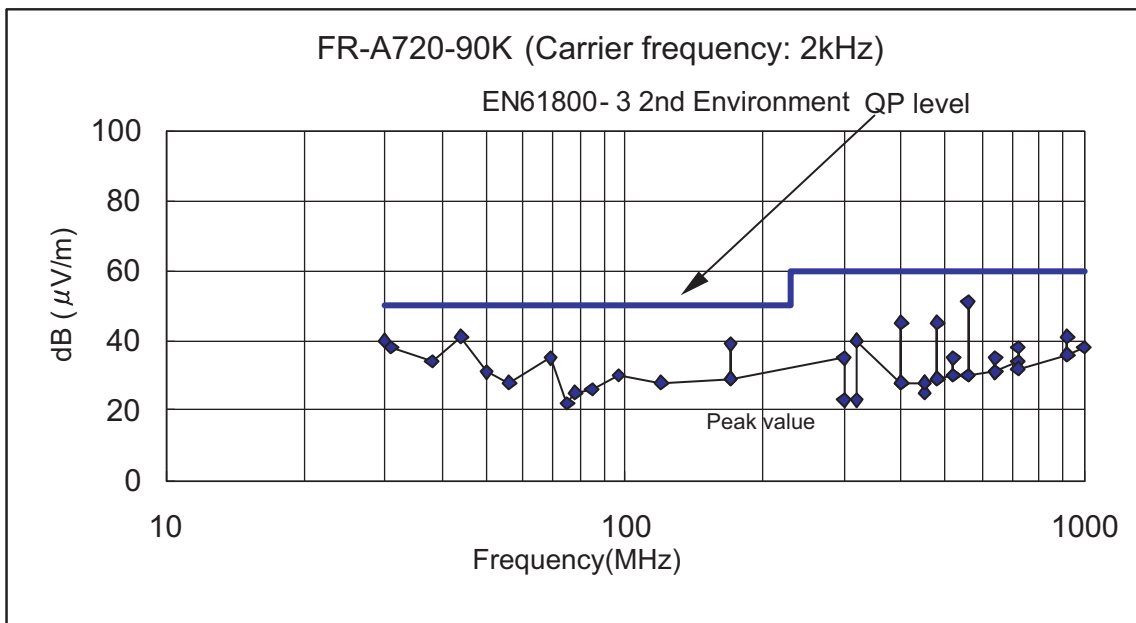

(Note) The QP value will not exceed the peak value.

# FR-A740

## <<Conditions>>

This inverter conforms with the product standard of EN61800-3.

Measurement was conducted according to the conditions of the product standard of EN61800-3 2nd environment.

Output wire length: 5m

Output cable: Shielded cable

Enclosure: No-door type

Operation frequency: 30Hz

Carrier frequency: Refer to the each graph

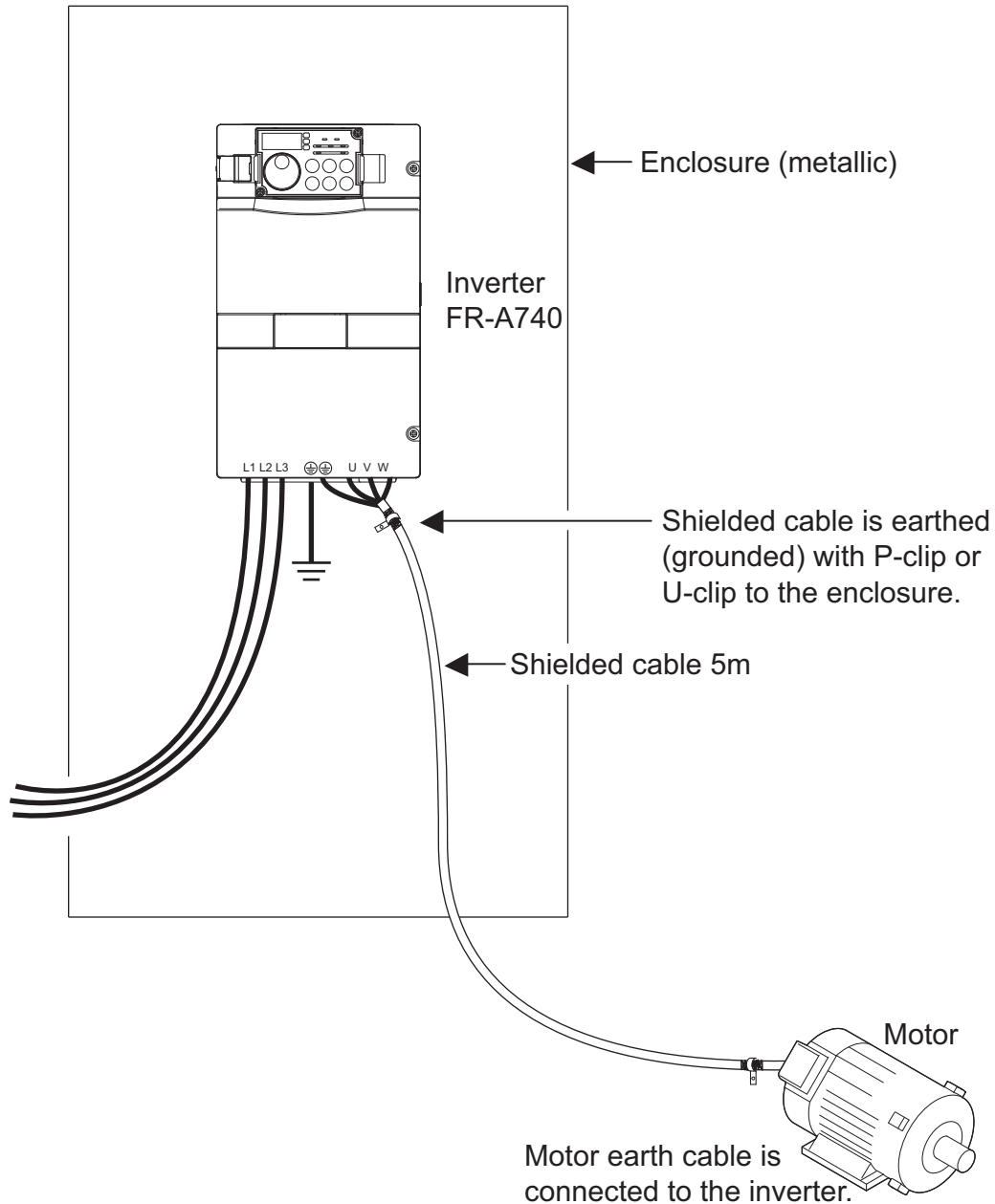



<<Measurement result>>

- FR-A740-3.7K

© Conducted interference

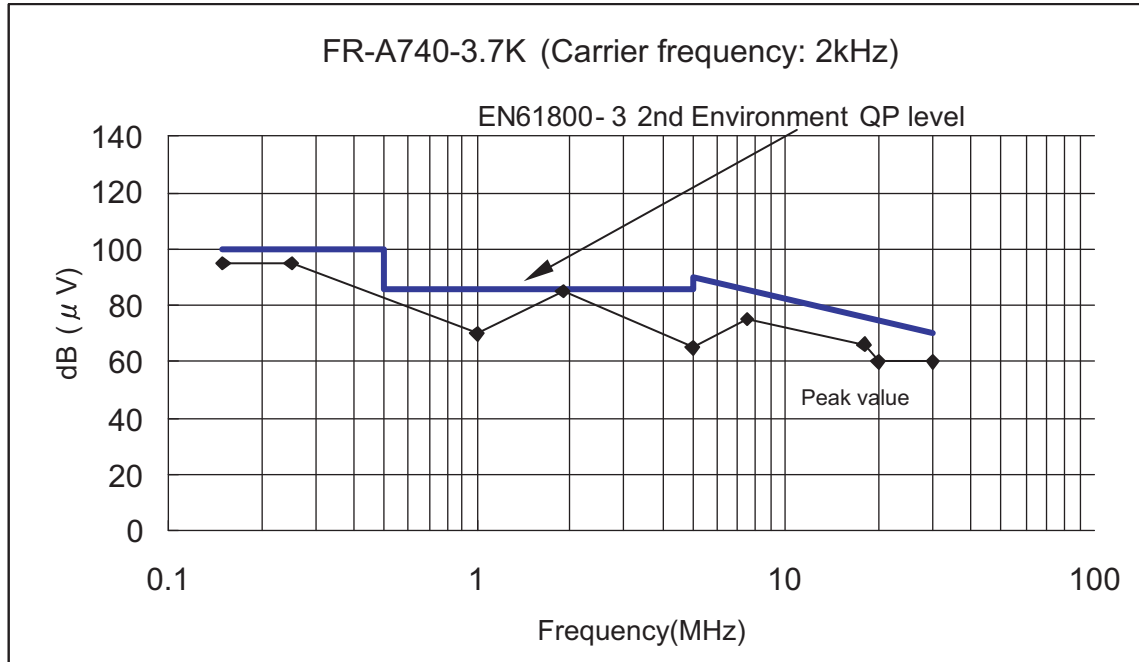

(Note) The QP value will not exceed the peak value.

© Radiated interference (10m site)

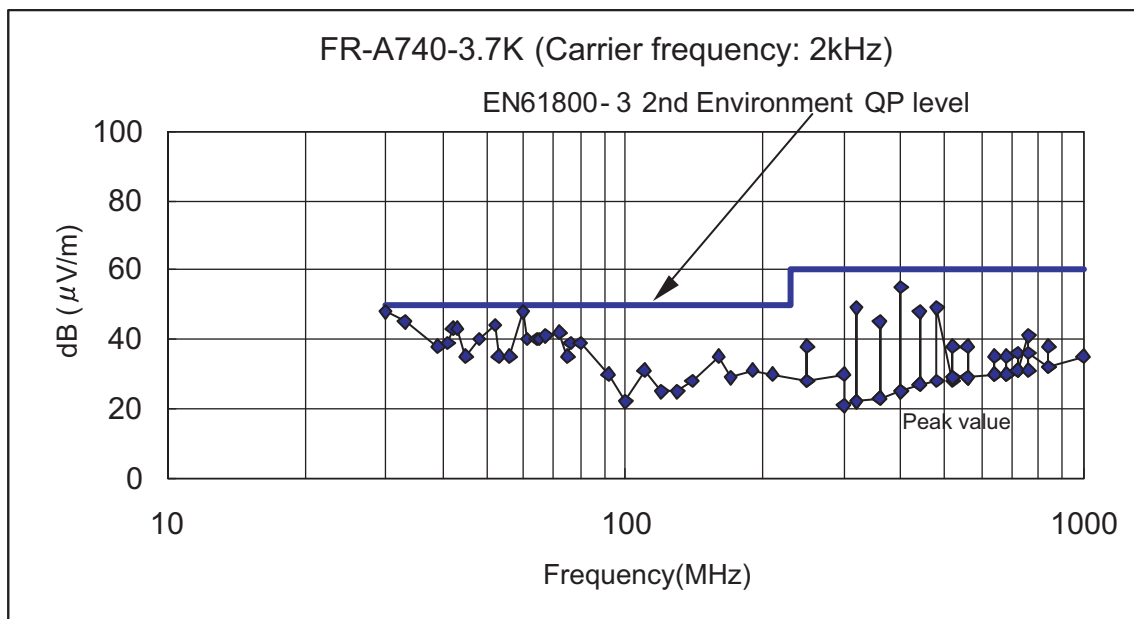

(Note) The QP value will not exceed the peak value.

• FR-A740-7.5K

© Conducted interference

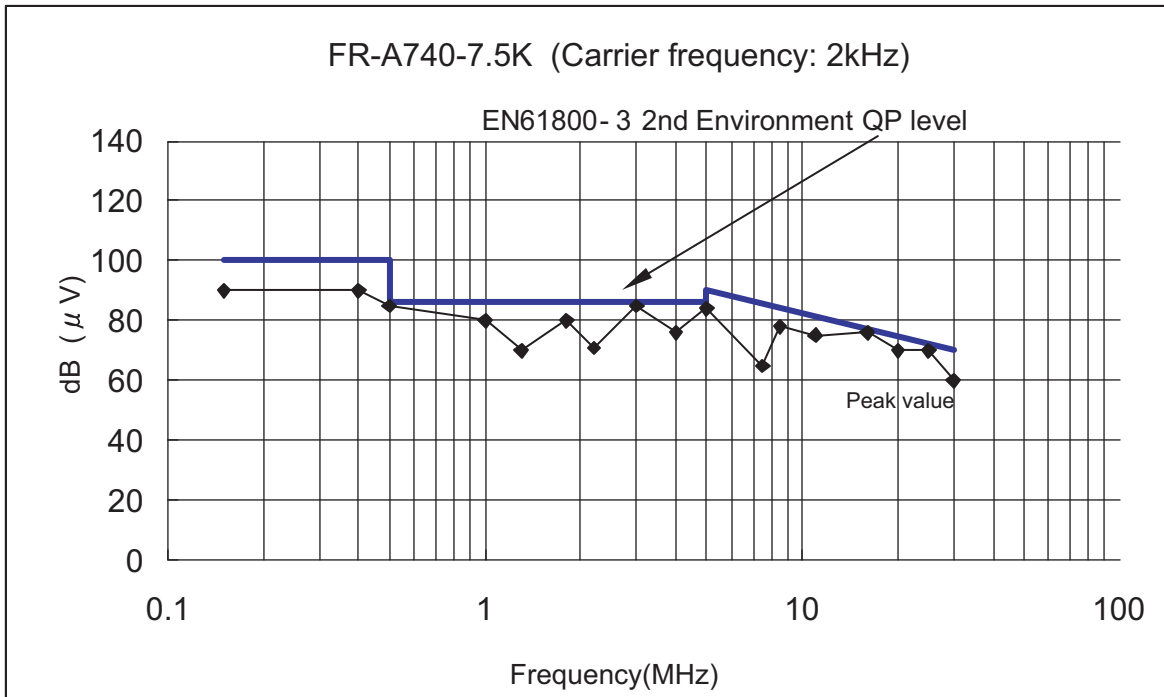

(Note) The QP value will not exceed the peak value.

© Radiated interference (10m site)

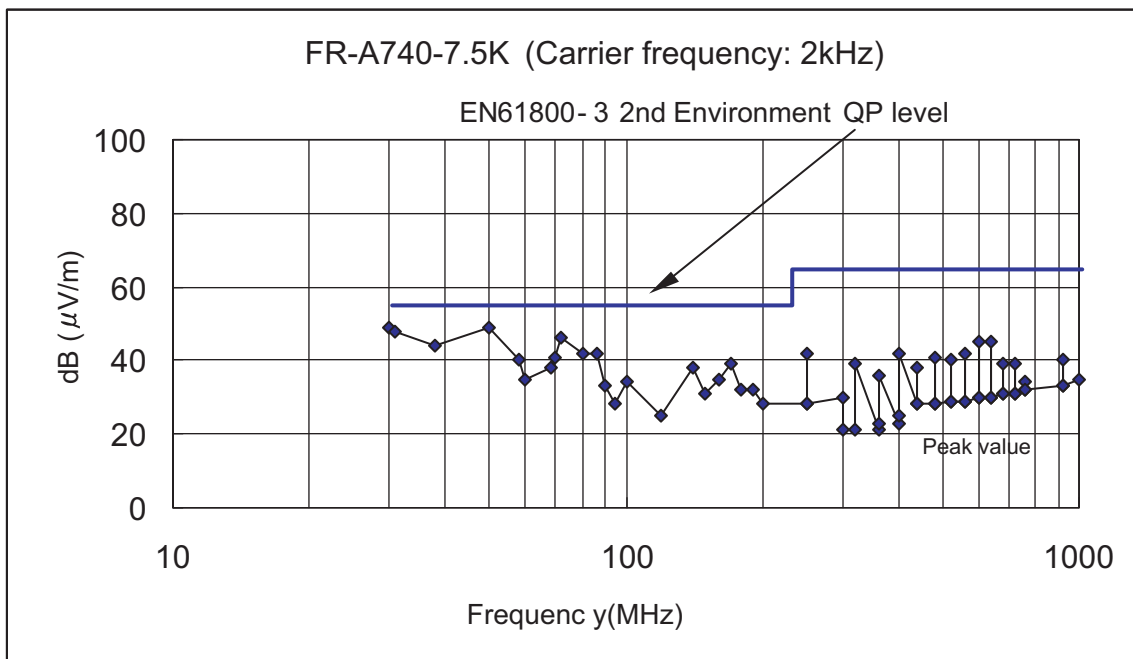

(Note) The QP value will not exceed the peak value.

• FR-A740-15K

© Conducted interference

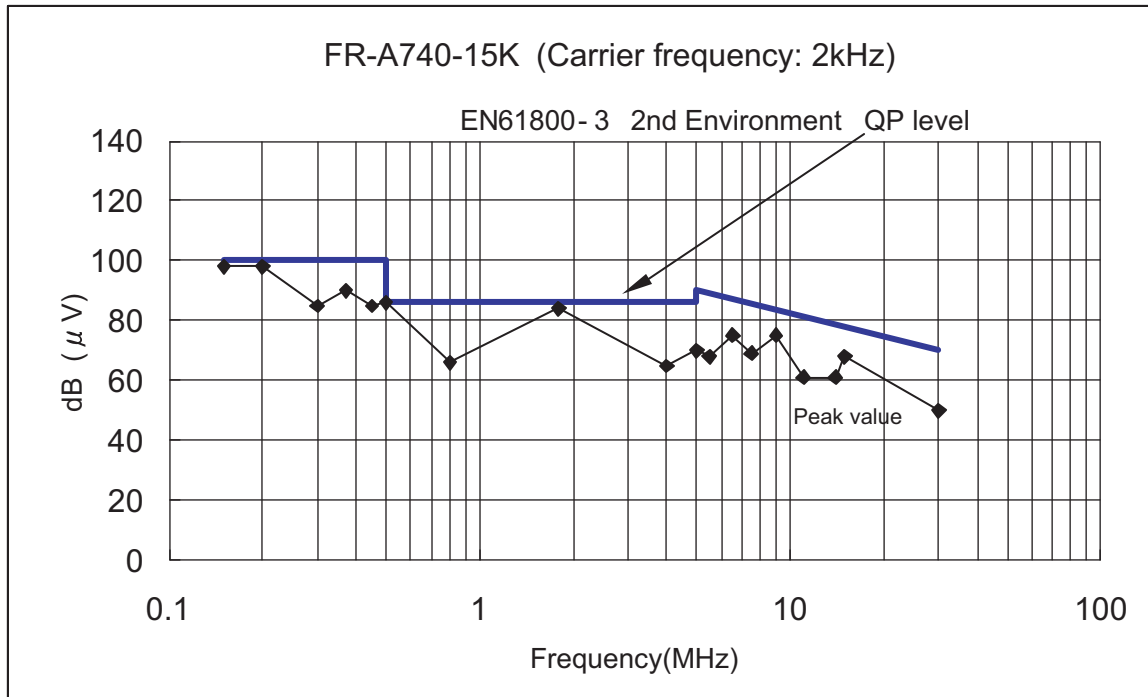

(Note) The QP value will not exceed the peak value.

© Radiated interference (10m site)

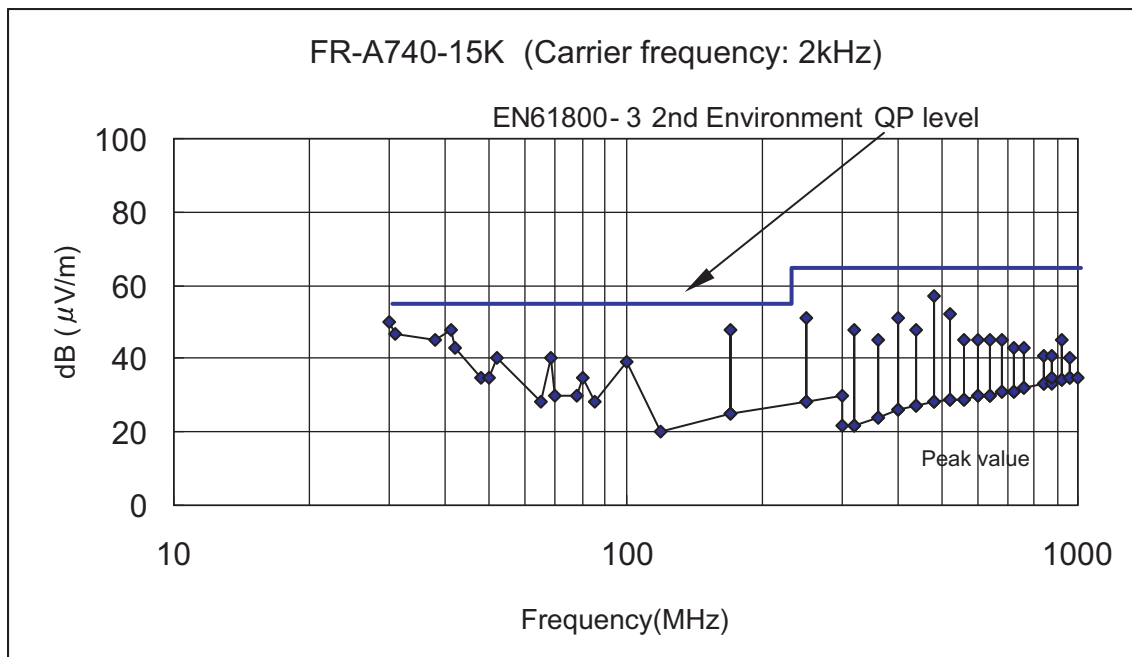

(Note) The QP value will not exceed the peak value.

• FR-A740-18.5K

© Conducted interference

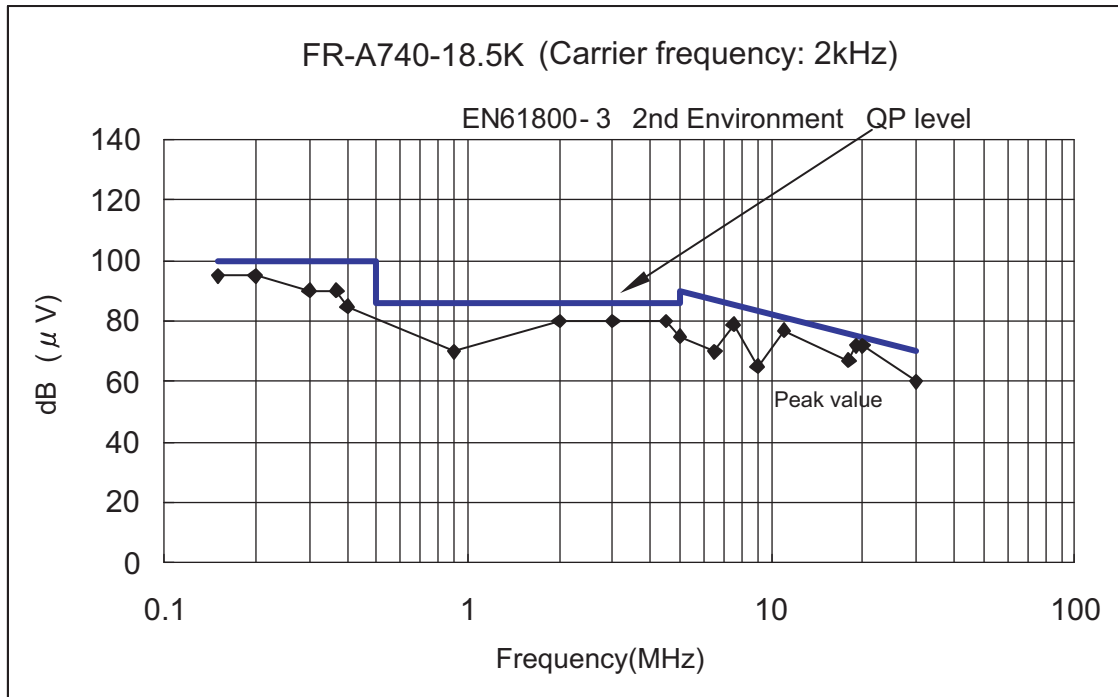

(Note) The QP value will not exceed the peak value.

© Radiated interference (10m site)

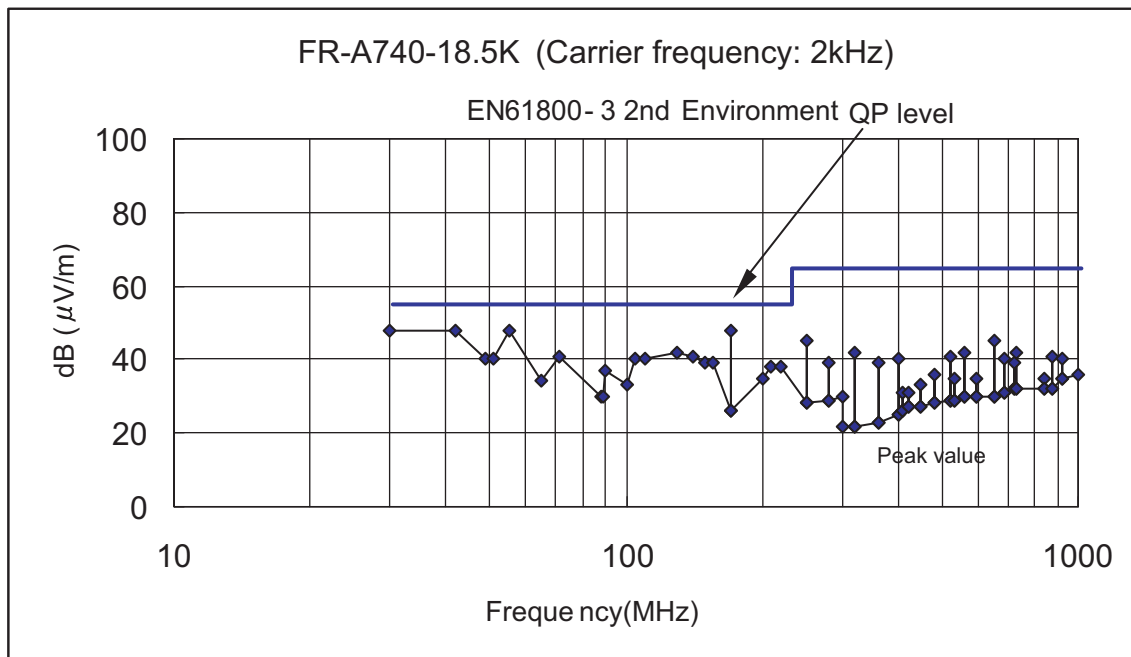

(Note) The QP value will not exceed the peak value.

• FR-A740-22K

© Conducted interference

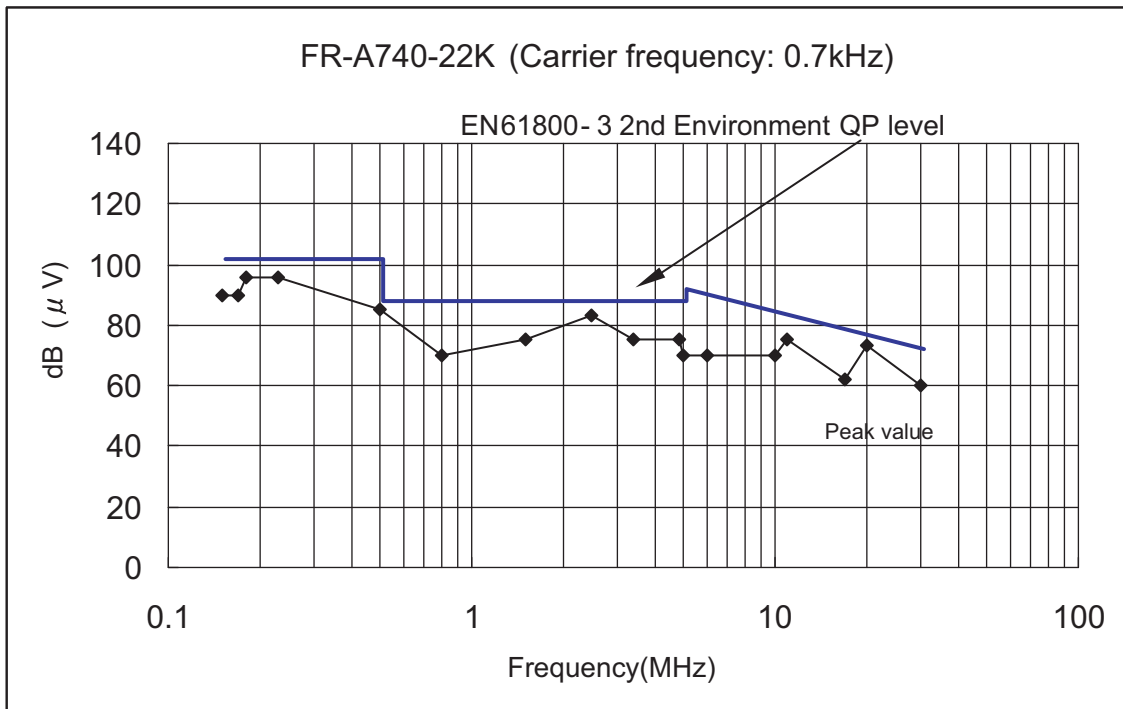

(Note) The QP value will not exceed the peak value.

© Radiated interference (10m site)

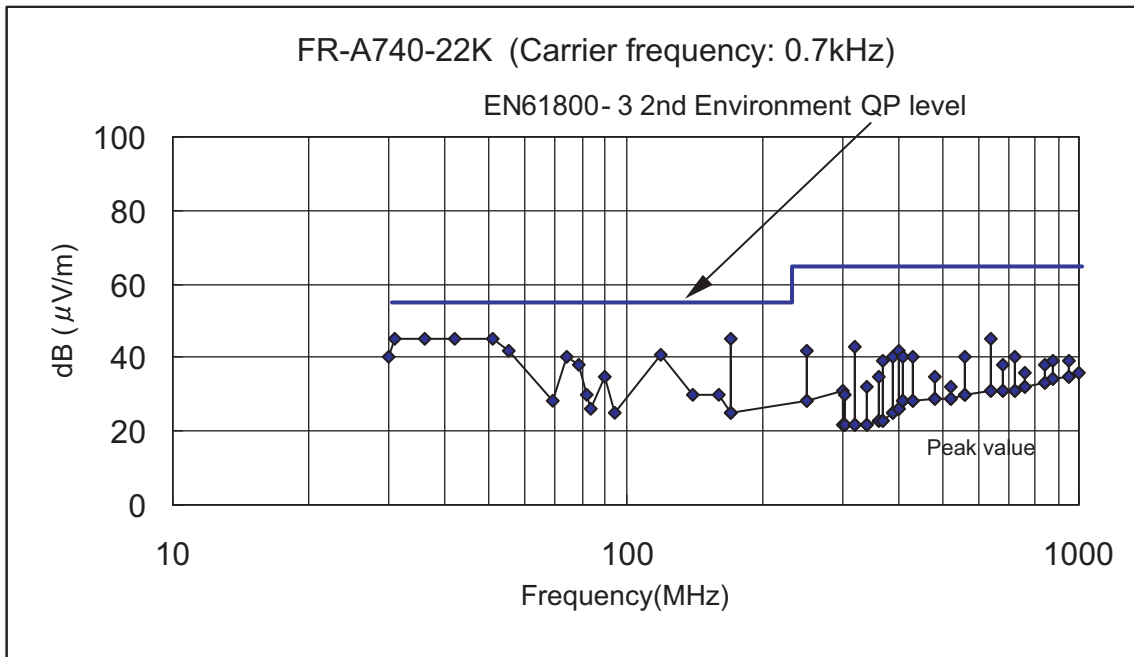

(Note) The QP value will not exceed the peak value.

The 22K model does not conform with the EN61800-3 Second Environment under Real sensorless vector control or the vector control.

• FR-A740-55K

© Conducted interference

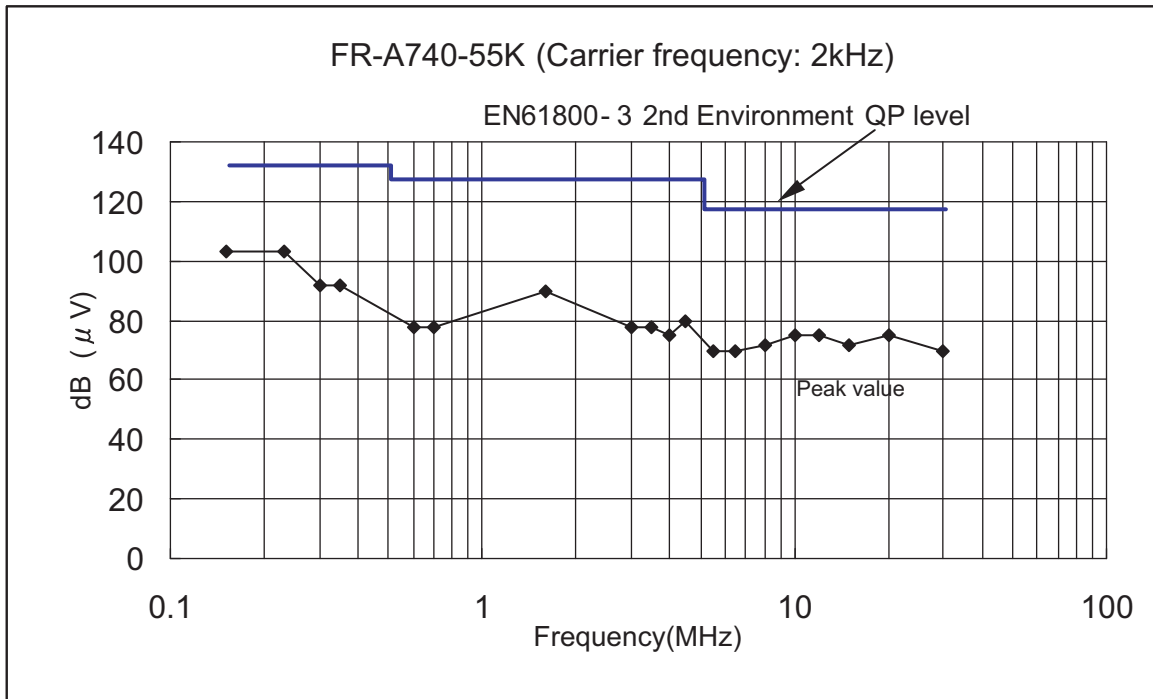

(Note) The QP value will not exceed the peak value.

© Radiated interference (10m site)

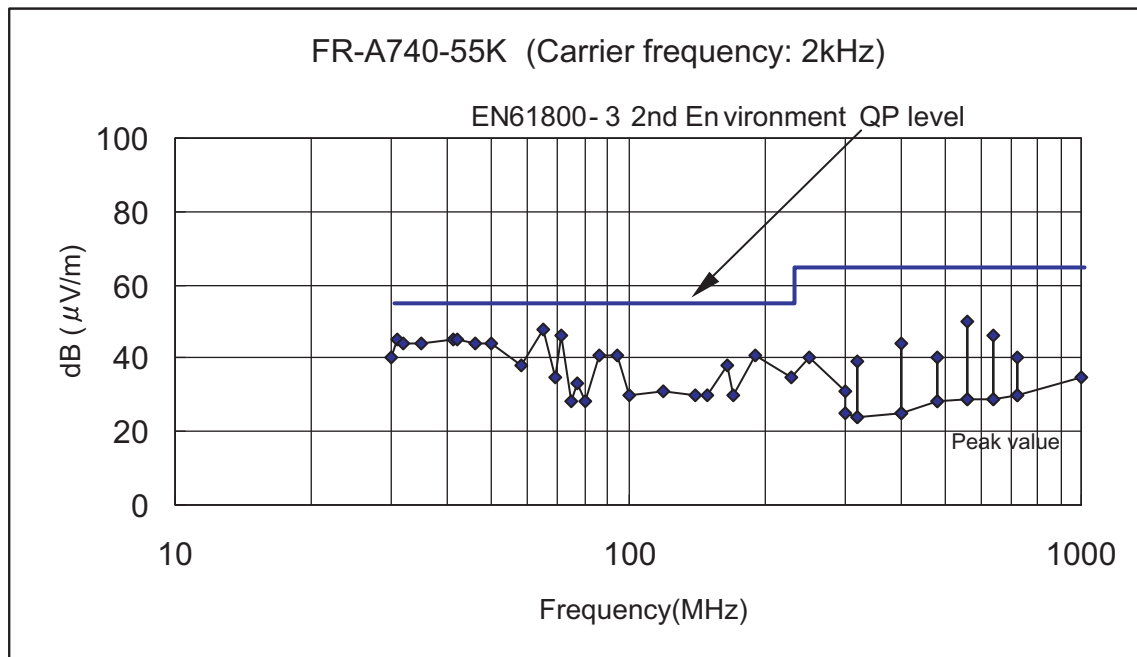

(Note) The QP value will not exceed the peak value.

• FR-A740-90K

© Conducted interference

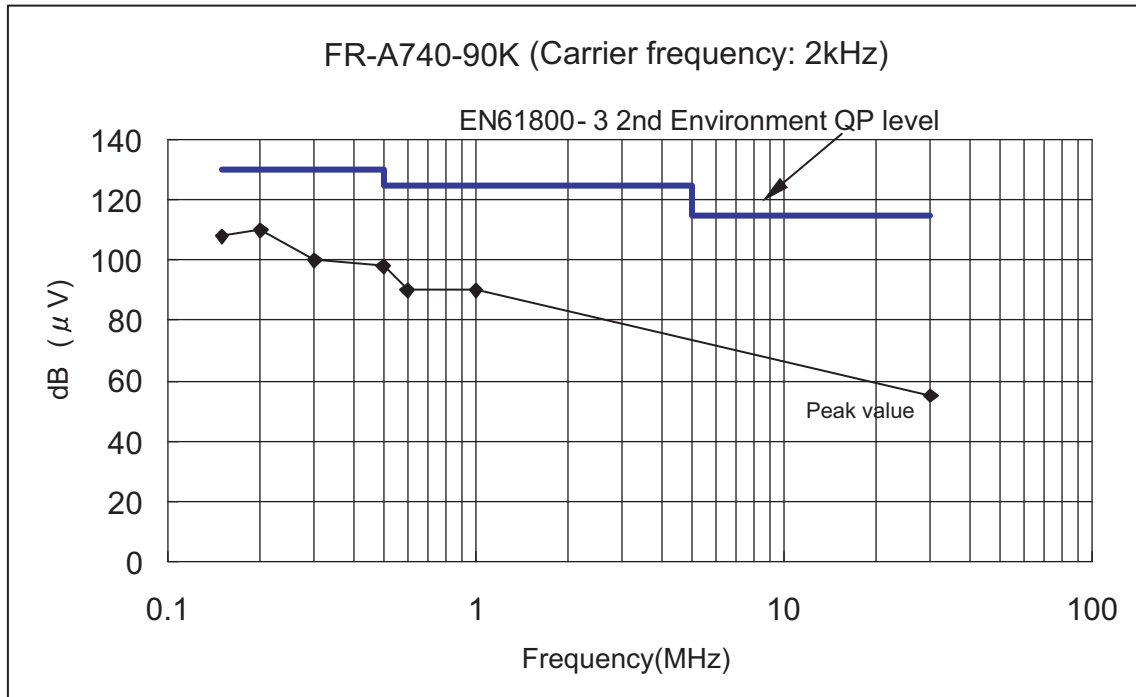

(Note) The QP value will not exceed the peak value.

© Radiated interference (10m site)

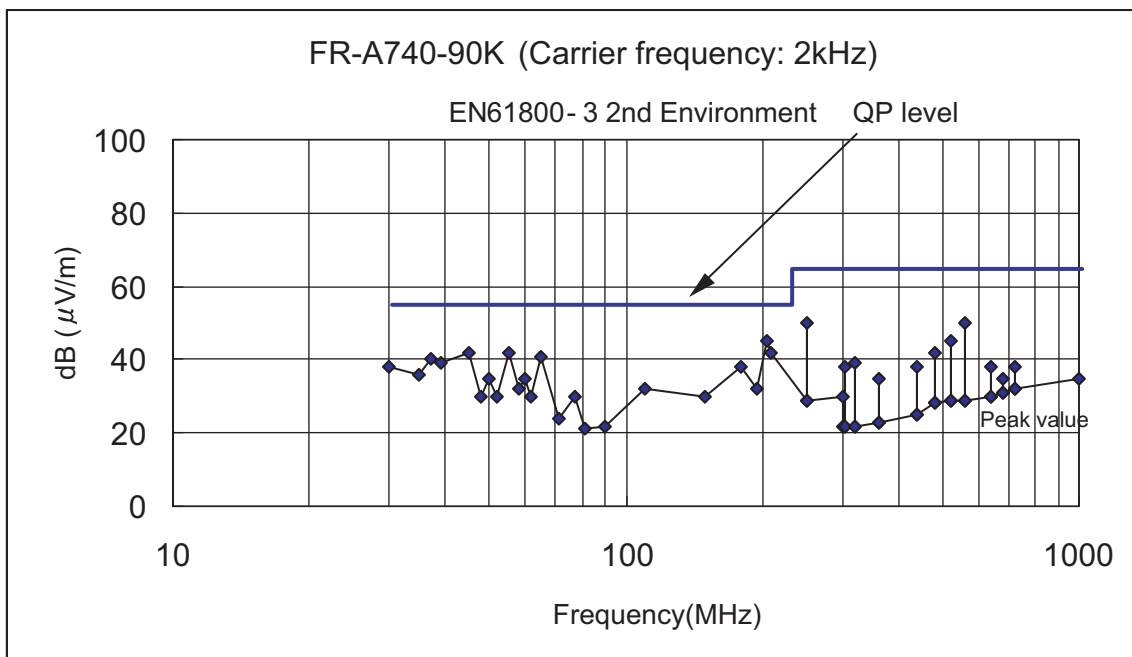

(Note) The QP value will not exceed the peak value.

• FR-A740-132K

© Conducted interference

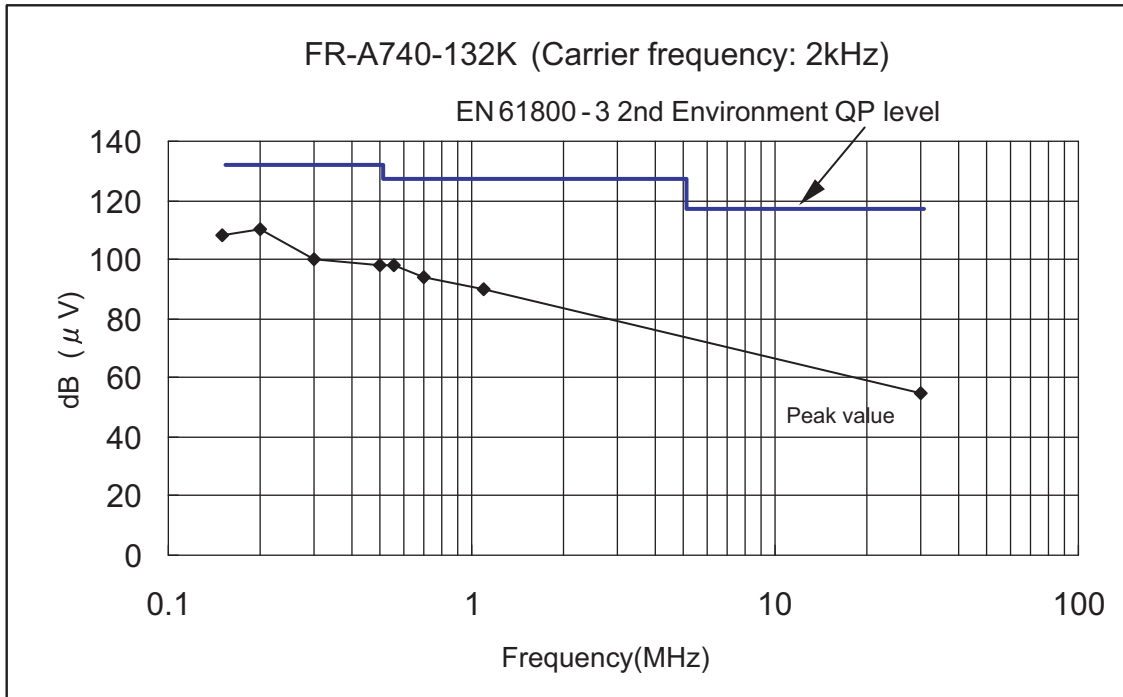

(Note) The QP value will not exceed the peak value.

© Radiated interference (10m site)

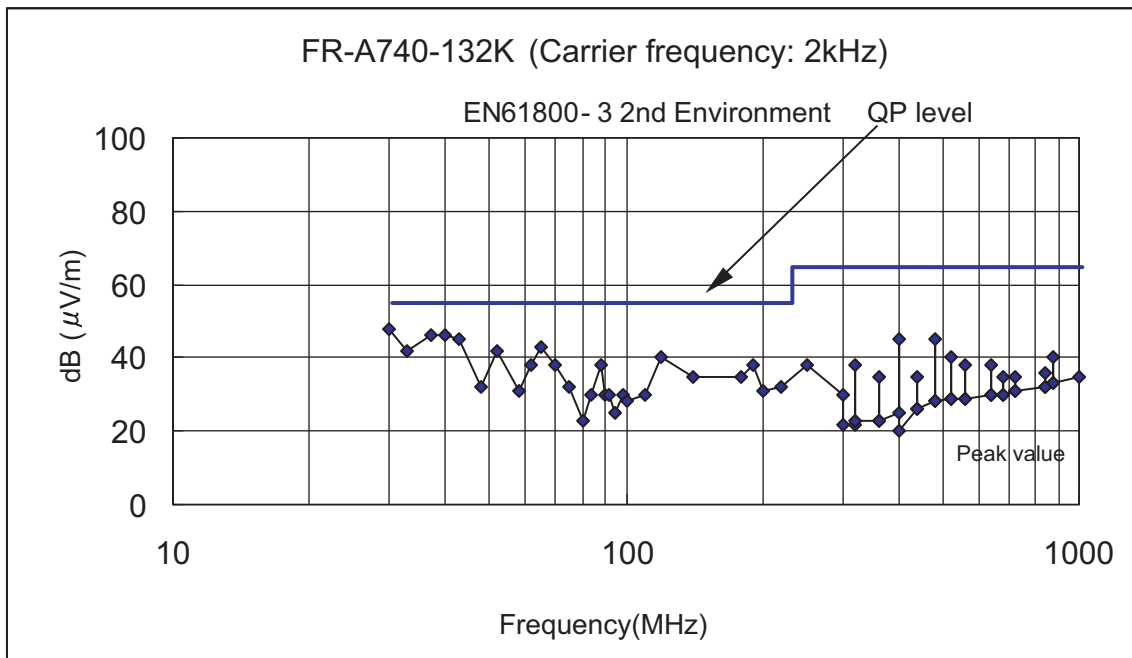

(Note) The QP value will not exceed the peak value.



• FR-A740-185K

© Conducted interference

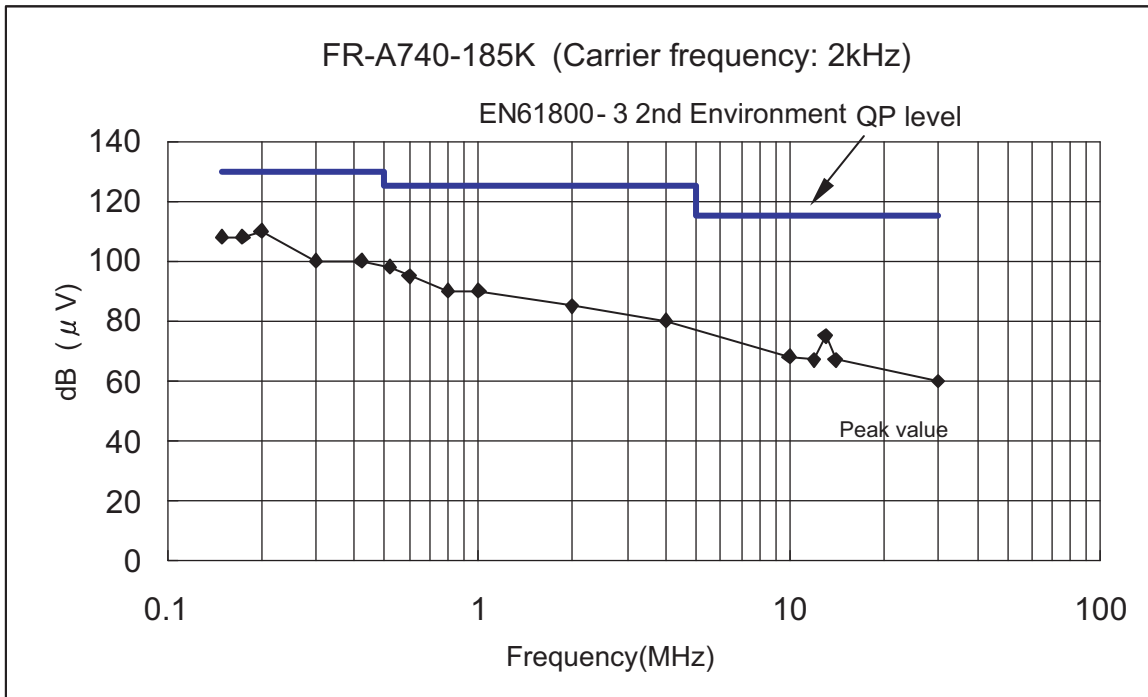

(Note) The QP value will not exceed the peak value.

© Radiated interference (10m site)

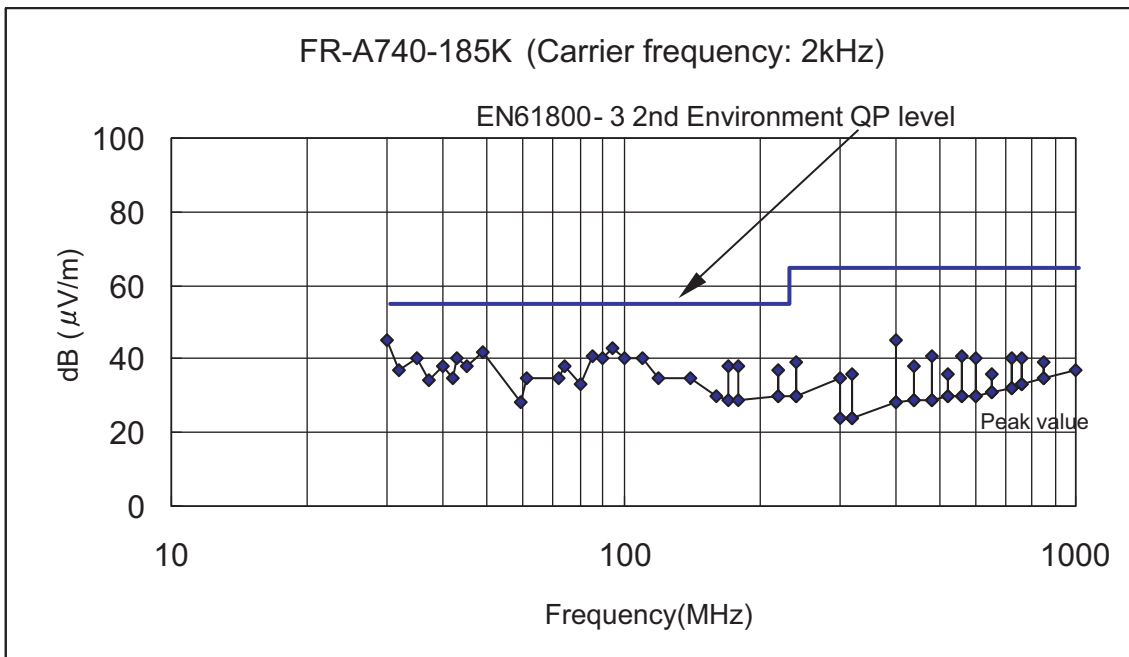

(Note) The QP value will not exceed the peak value.

• FR-A740-280K

© Conducted interference

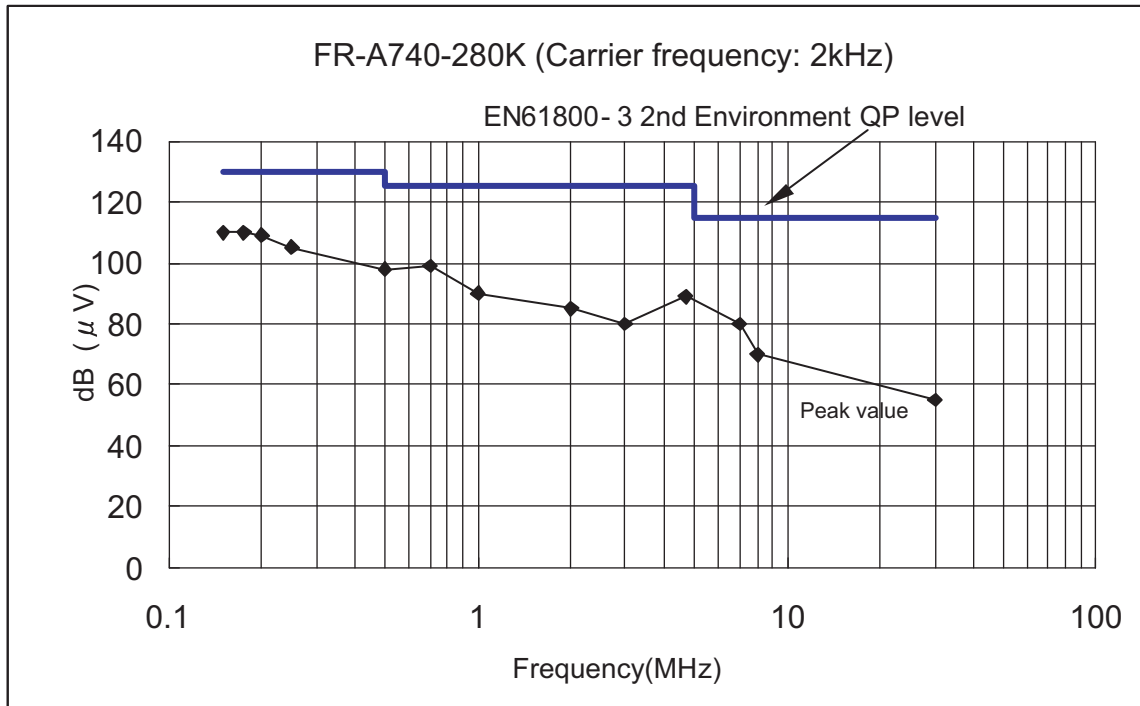

(Note) The QP value will not exceed the peak value.

© Radiated interference (10m site)

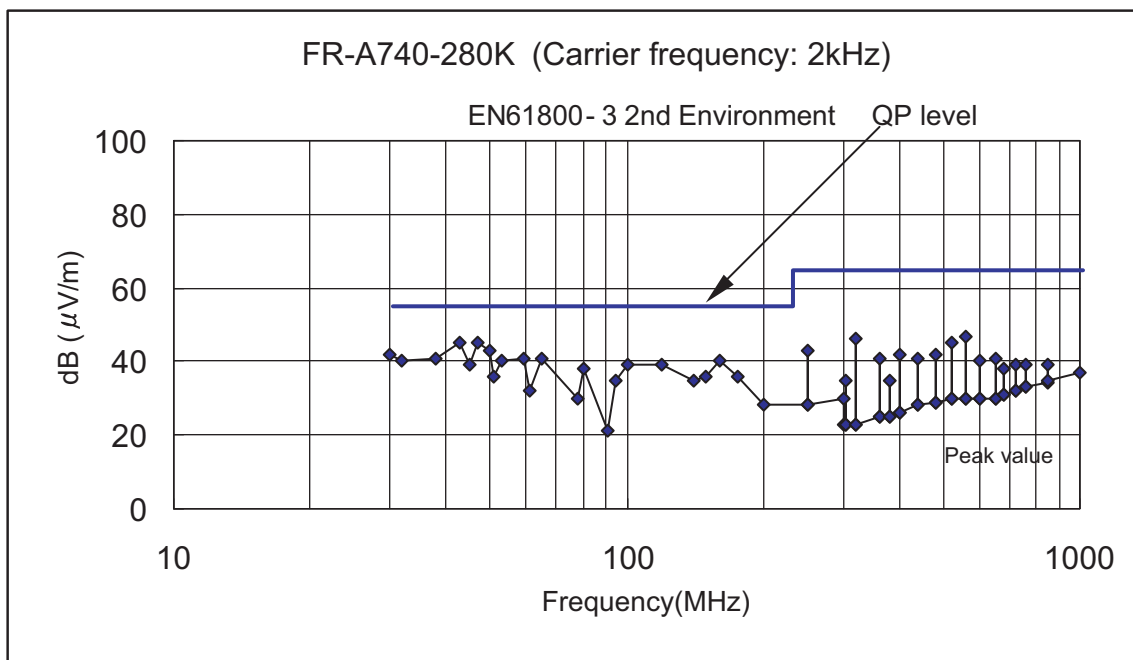

(Note) The QP value will not exceed the peak value.

• FR-A740-355K

© Conducted interference

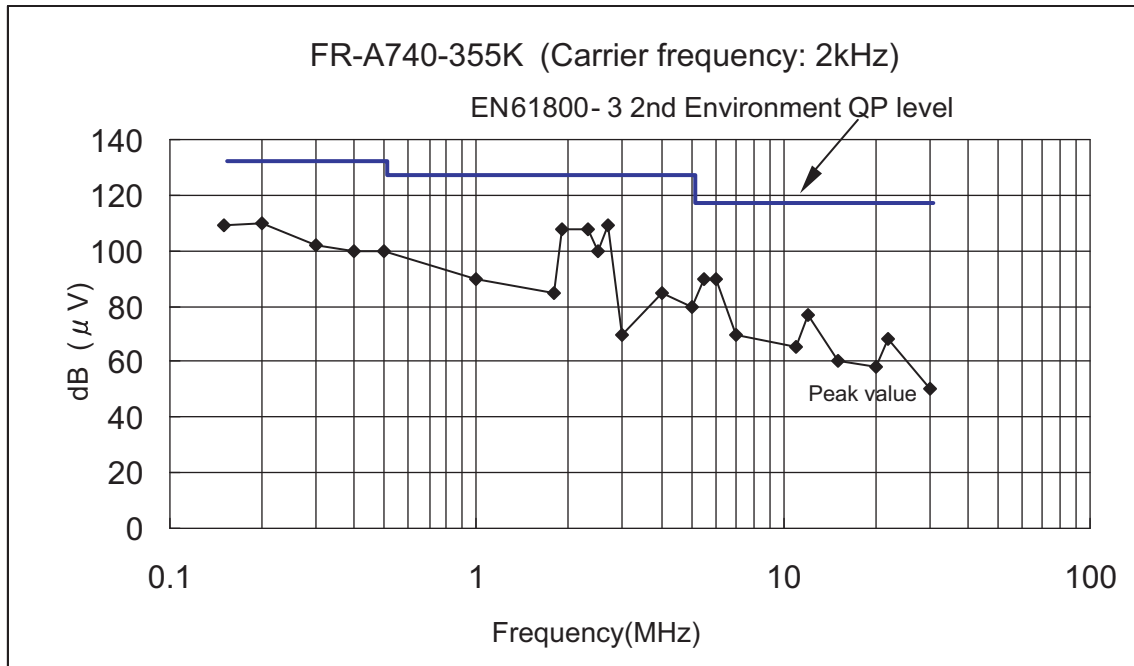

(Note) The QP value will not exceed the peak value.

© Radiated interference (10m site)

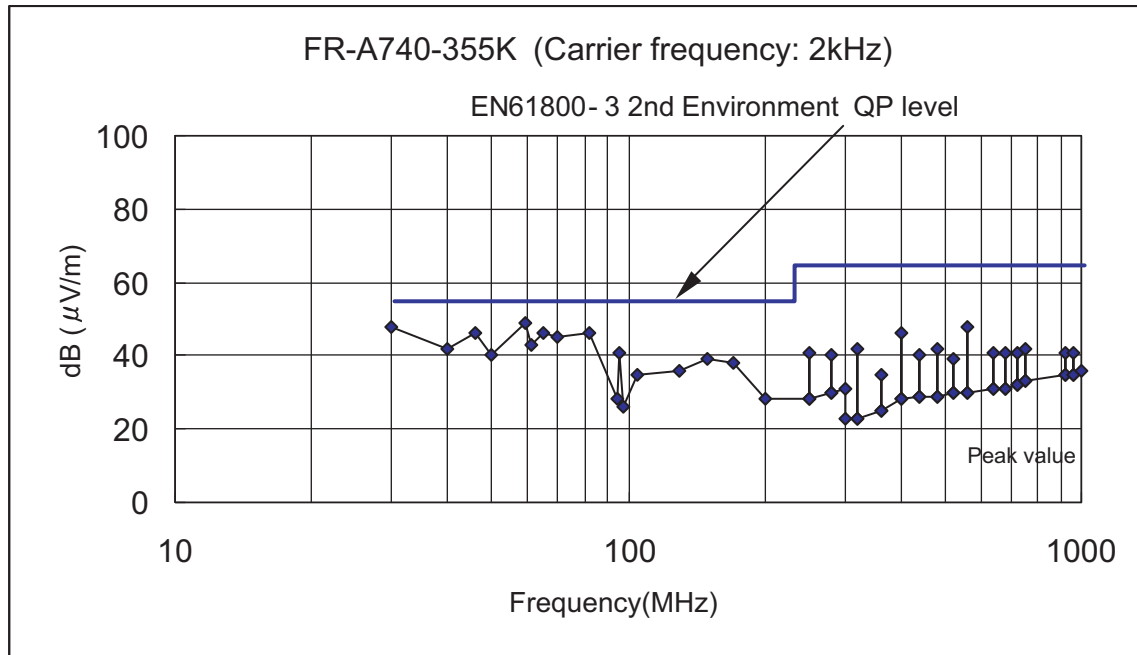

(Note) The QP value will not exceed the peak value.

# FR-A741

## <<Conditions>>

This inverter conforms with the product standard of EN61800-3.

Measurement was conducted according to the conditions of the product standard of EN61800-3 2nd environment.

Output wire length: 20m

Output cable: Shielded cable

Equipment is installed in the enclosure.

Operation frequency: 30Hz

Carrier frequency: Refer to the each graph

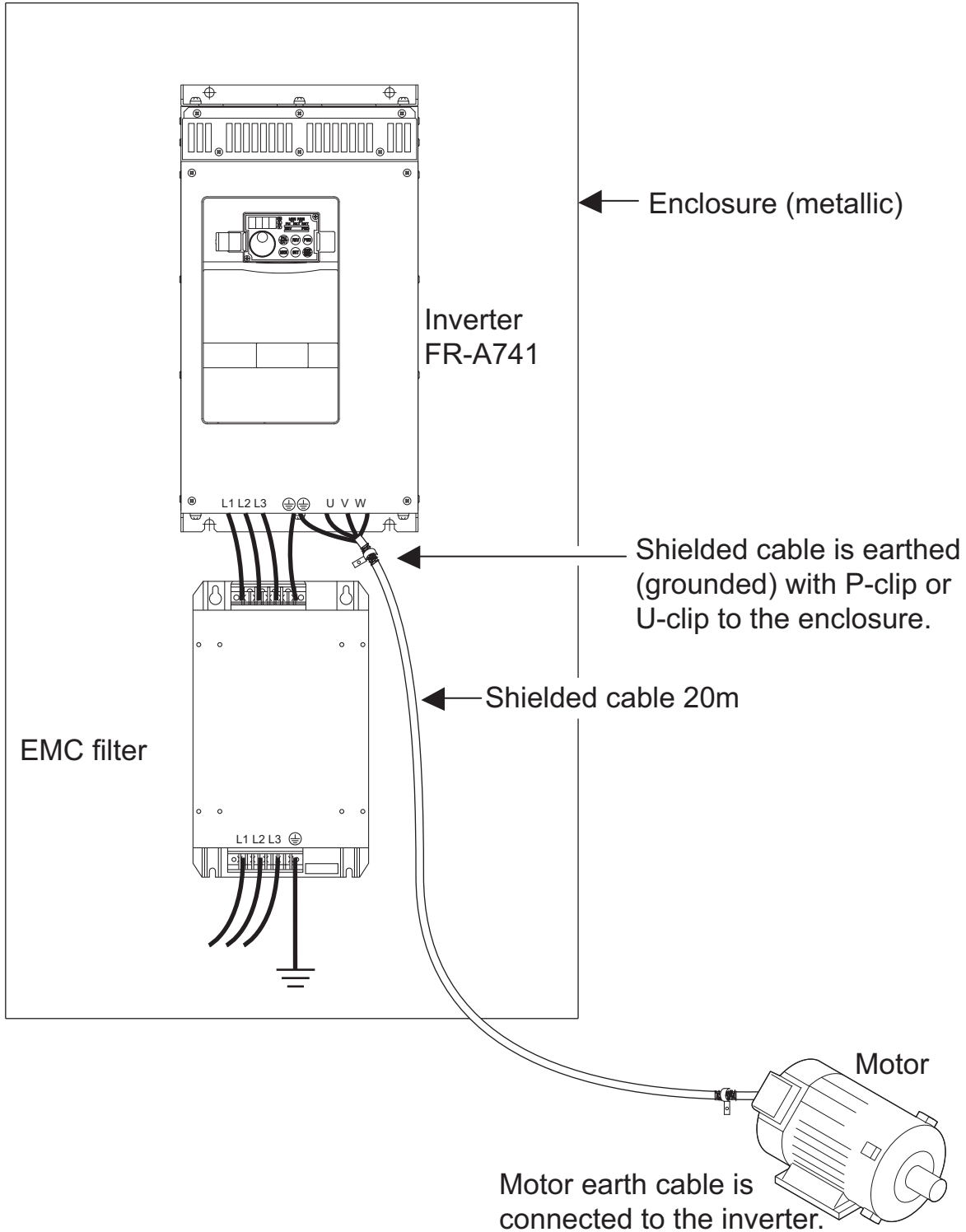

• FR-A741-7.5K, SF1174

© Conducted interference

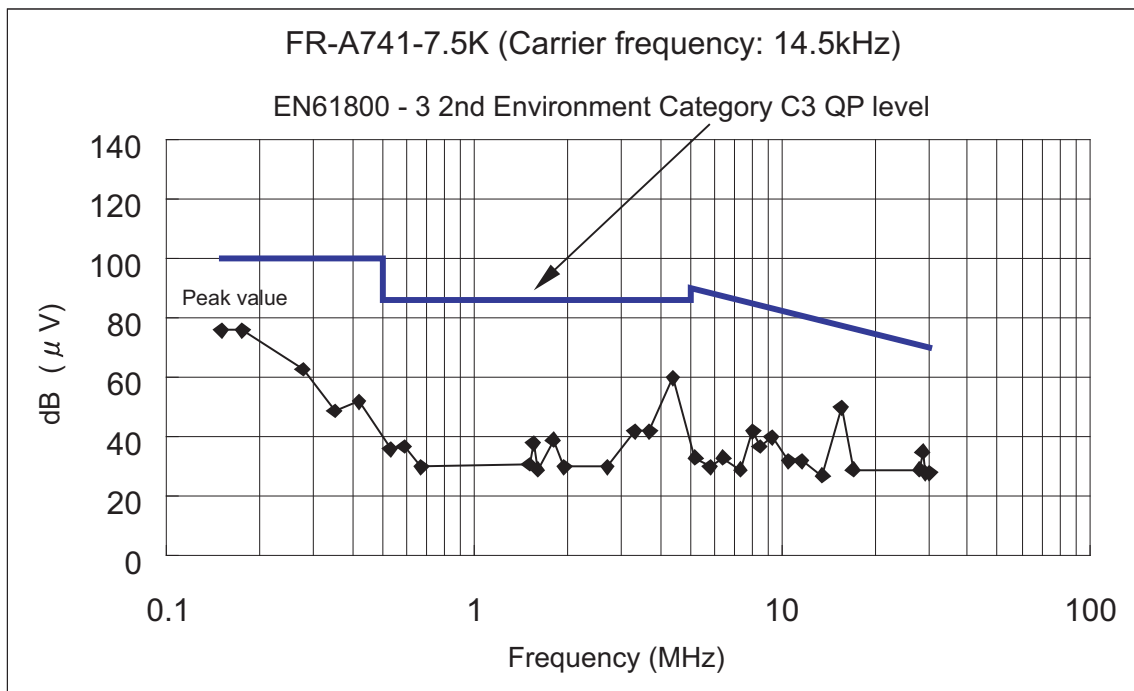

(Note) The QP value will not exceed the peak value.

© Radiated interference(10m site)

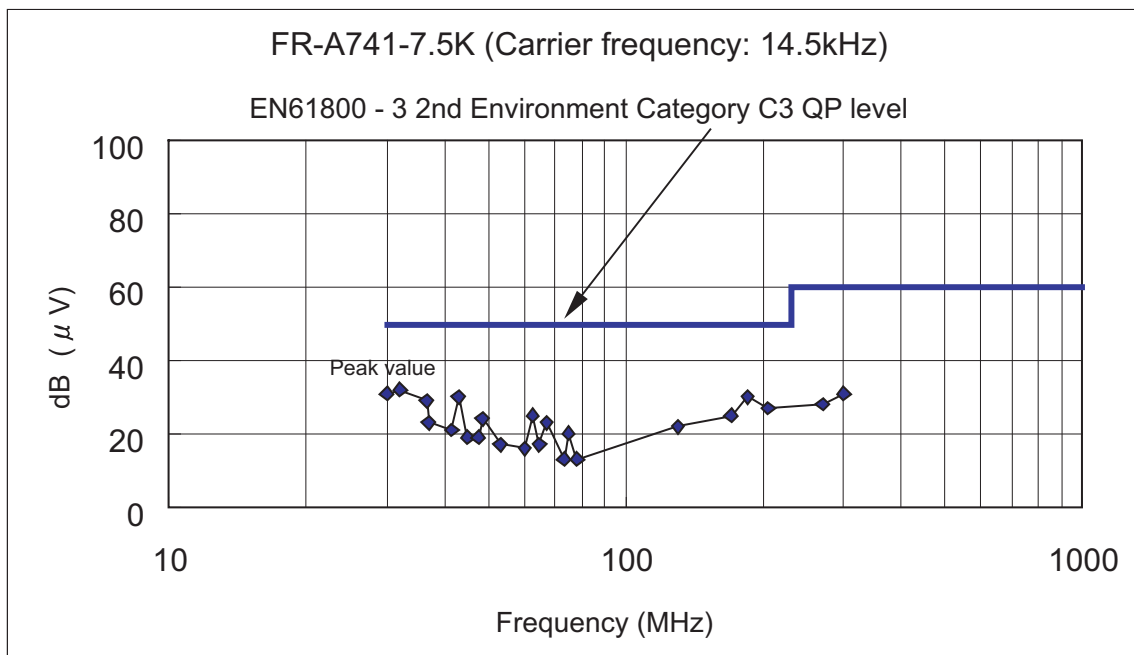

(Note) The QP value will not exceed the peak value.

• FR-A741-15K, SF1175

© Conducted interference

(Note) FR-BLF(4-turn) is installed in the input side.

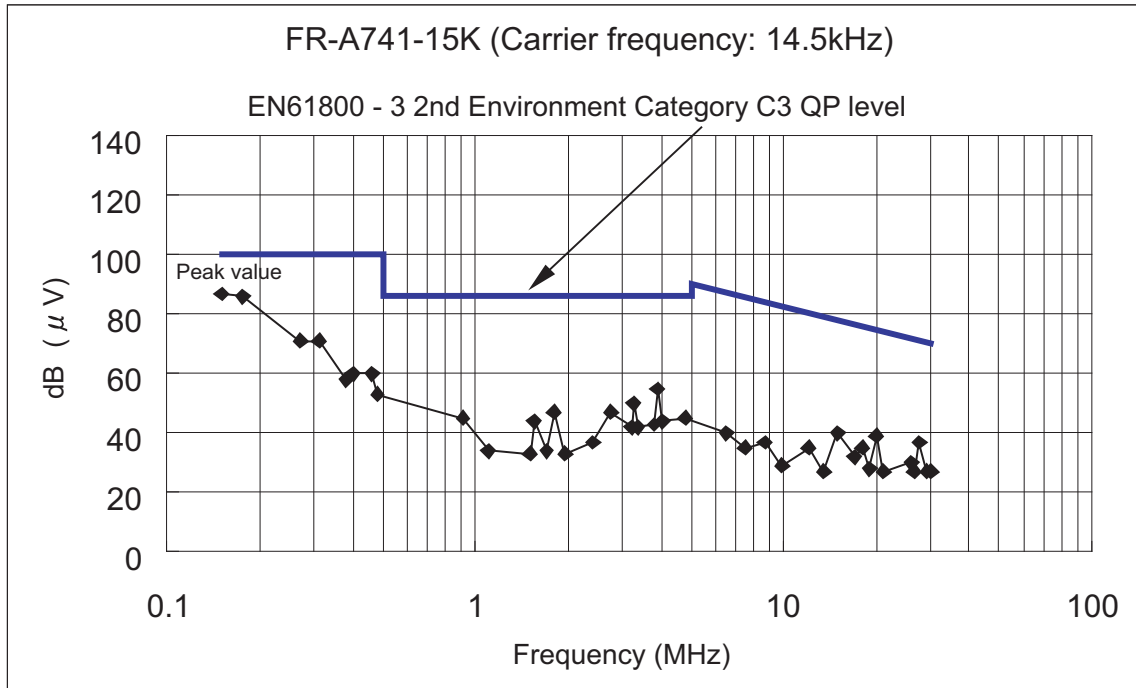

(Note) The QP value will not exceed the peak value.

© Radiated interference(10m site)

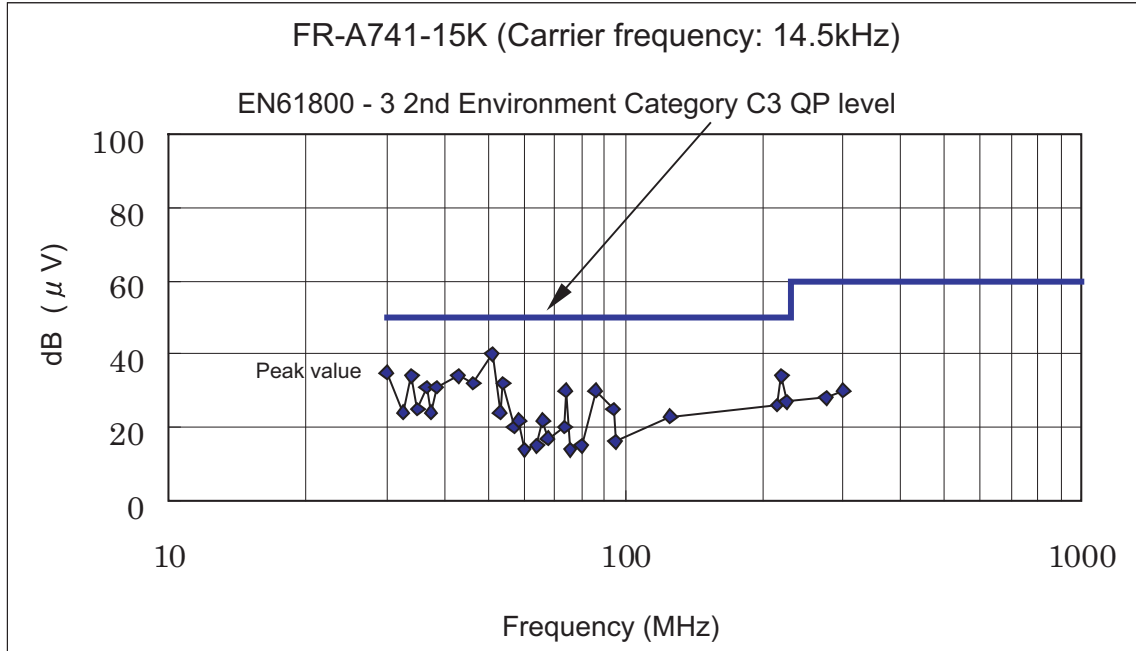

(Note) The QP value will not exceed the peak value.

• FR-A741-22K, SF1176

◎ Conducted interference

(Note) FR-BLF(2-turn) is installed in the input side.

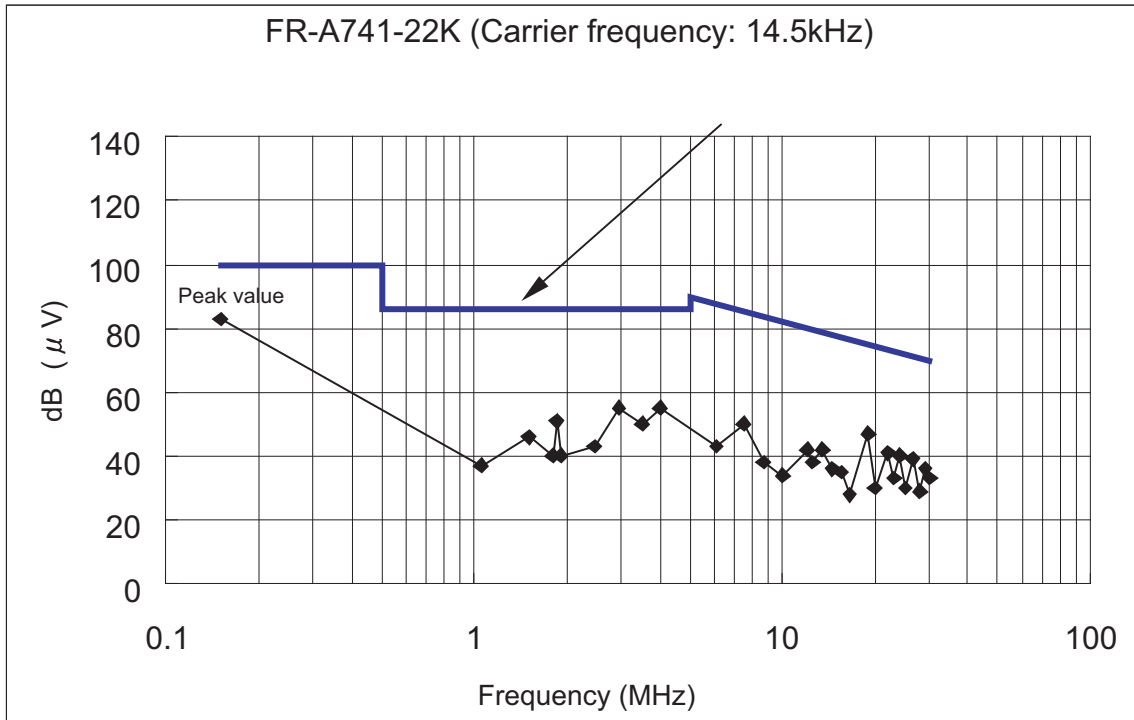

(Note) The QP value will not exceed the peak value.

◎ Radiated interference(10m site)

(Note) FR-BLF(2-turn) is installed in the input side.

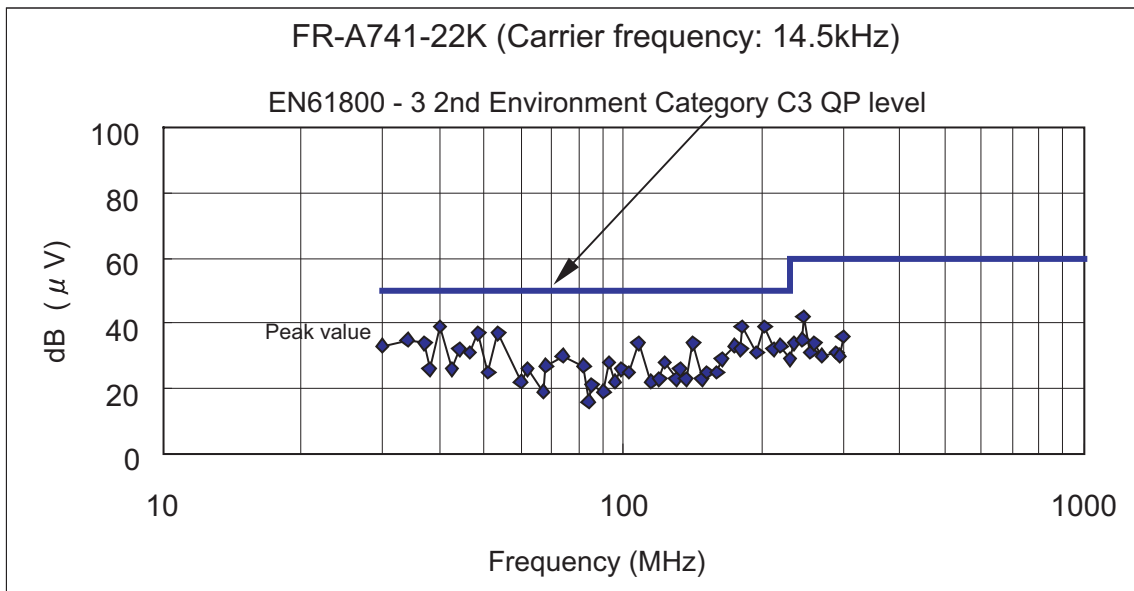

(Note) The QP value will not exceed the peak value.

• FR-A741-30K, SF1177

◎ Conducted interference

(Note) FR-BLF(4-turn) is installed in the input side.

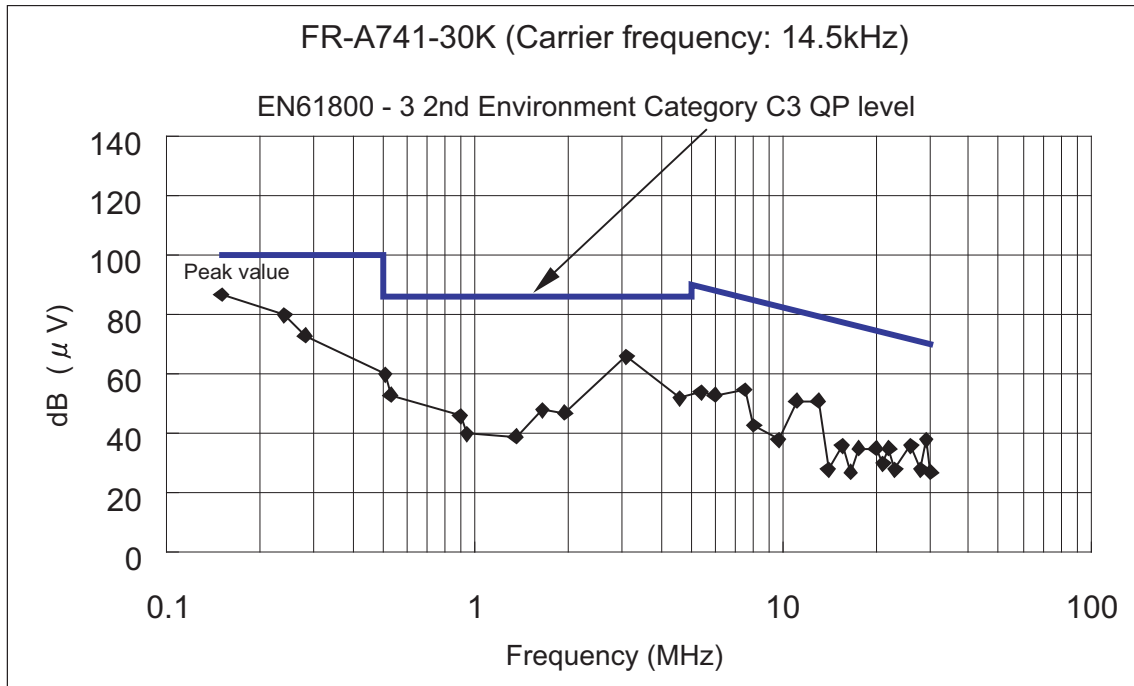

(Note) The QP value will not exceed the peak value.

◎ Radiated interference(10m site)

(Note) FR-BLF(4-turn) is installed in the input side.

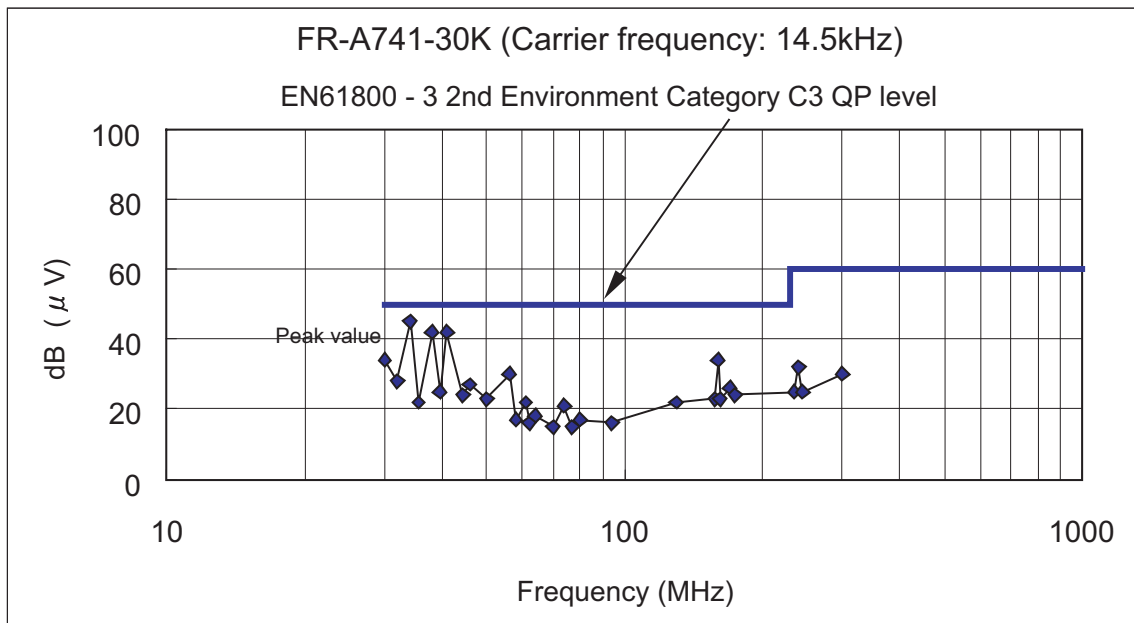

(Note) The QP value will not exceed the peak value.



• FR-A741-45K, SF1178

© Conducted interference

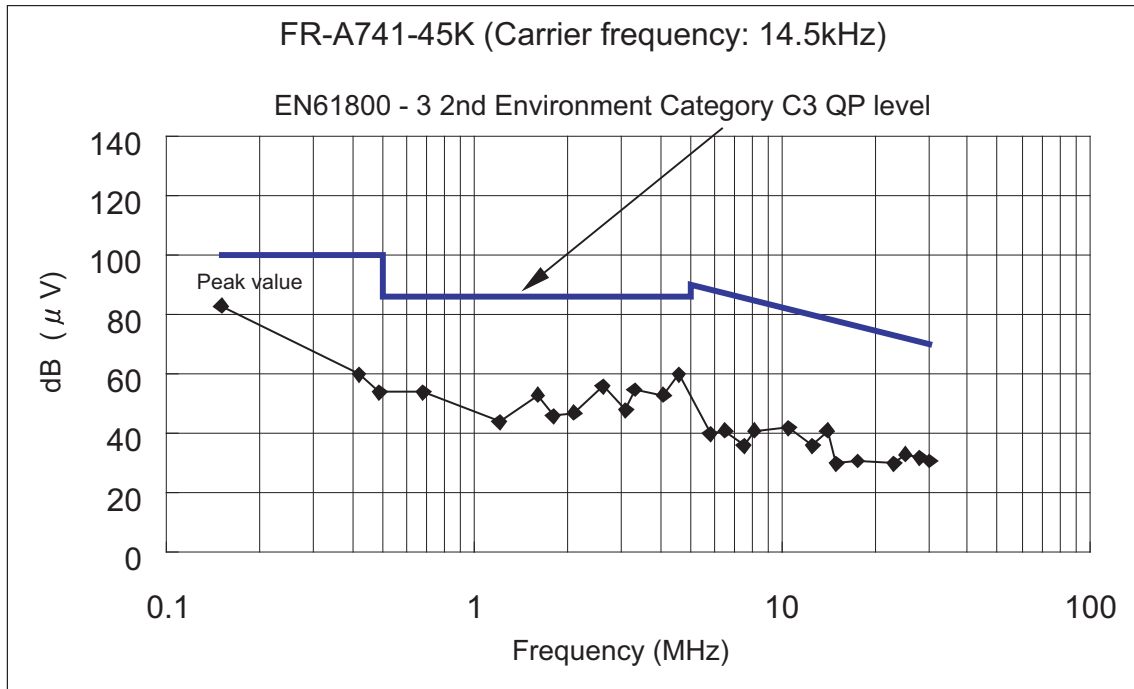

(Note) The QP value will not exceed the peak value.

© Radiated interference(10m site)

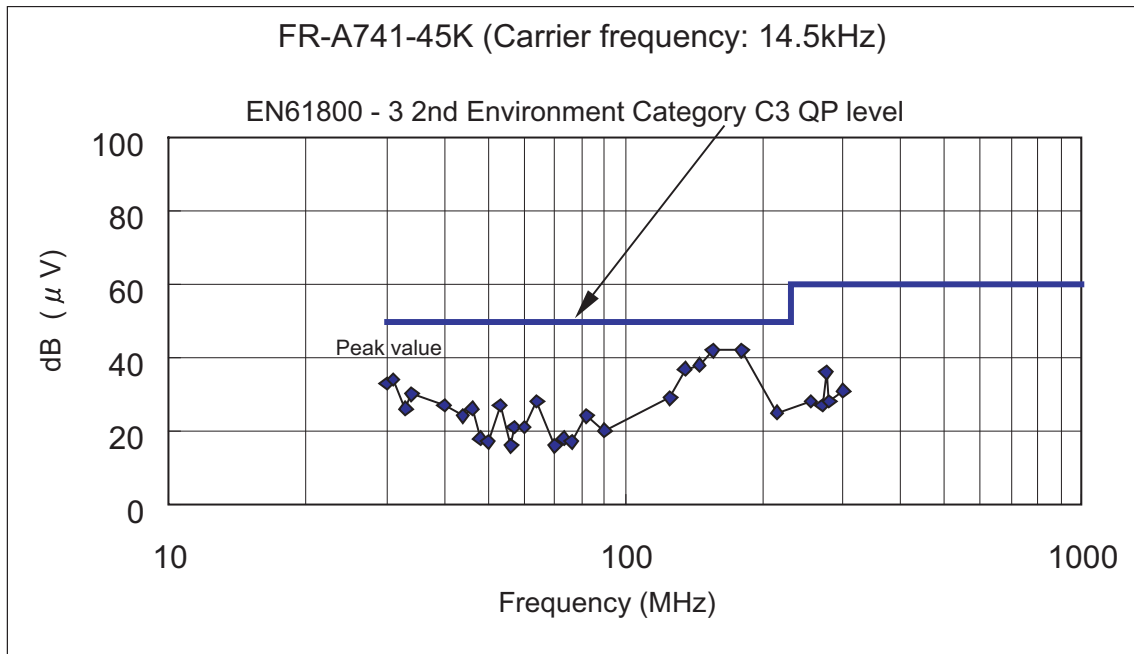

(Note) The QP value will not exceed the peak value.

• FR-A741-55K, SF1179

◎ Conducted interference

(Note) FR-BLF(1-turn) is installed in the input side, and FR-BLF(1-turn) is installed in the output side.

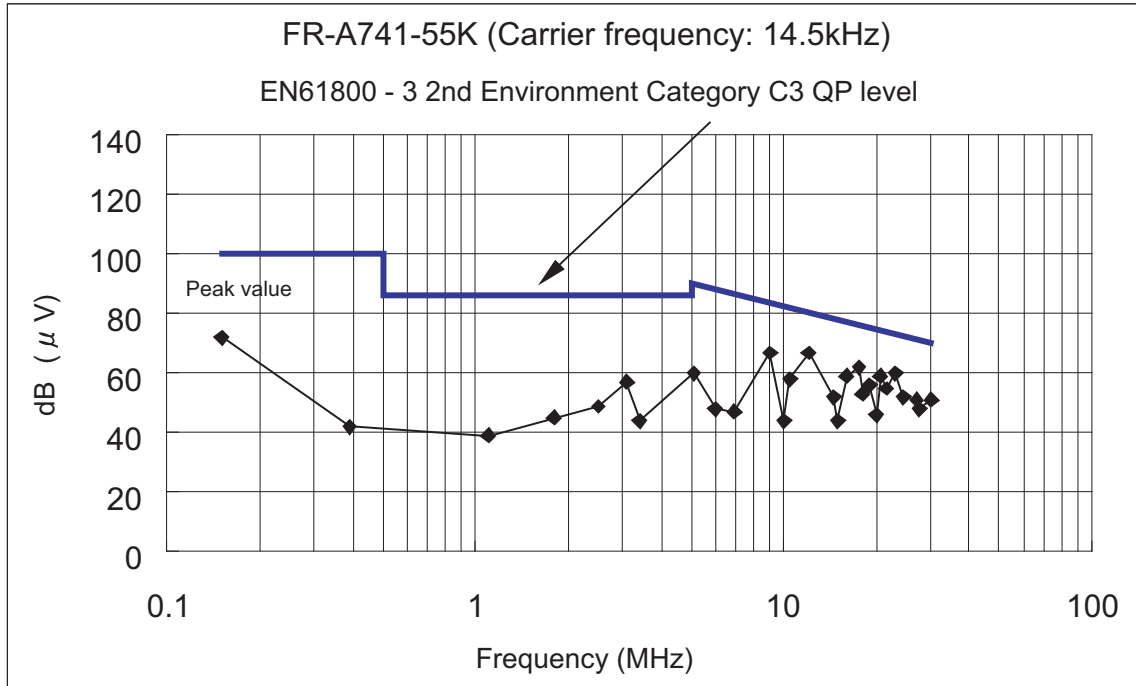

(Note) The QP value will not exceed the peak value.

◎ Radiated interference(10m site)

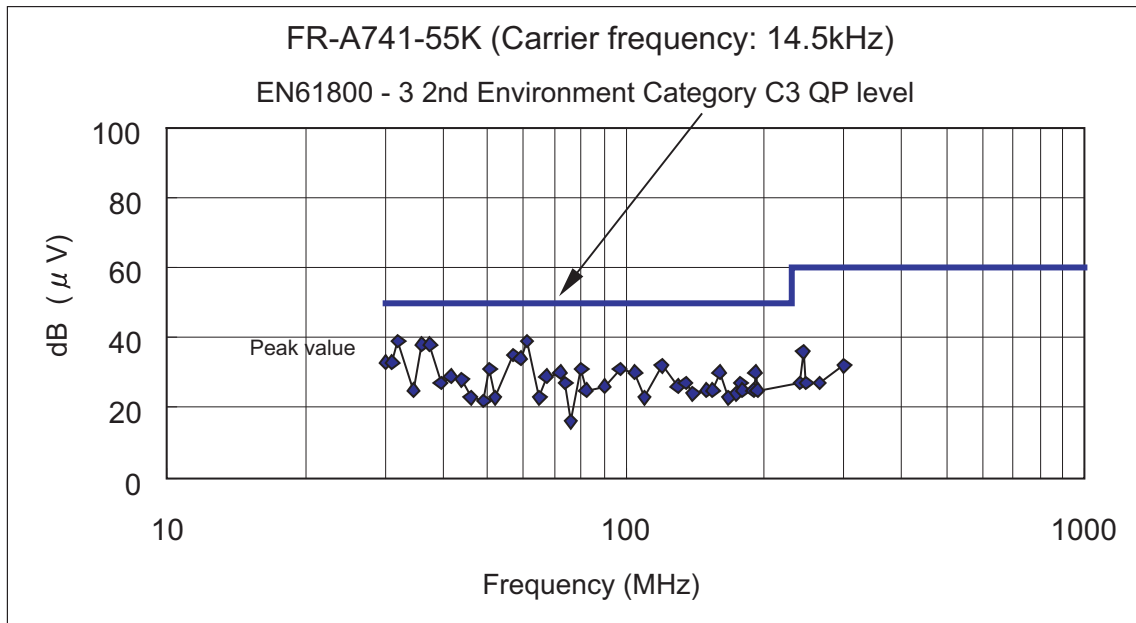

(Note) The QP value will not exceed the peak value.

# FR-F720

## <<Conditions>>

This inverter conforms with the product standard of EN61800-3.

Measurement was conducted according to the conditions of the product standard of EN61800-3 2nd environment.

Output wire length : 5m

Operation frequency: 30Hz

Output cable: Shielded cable

Carrier frequency: Refer to the each graph

Enclosure: No-door type

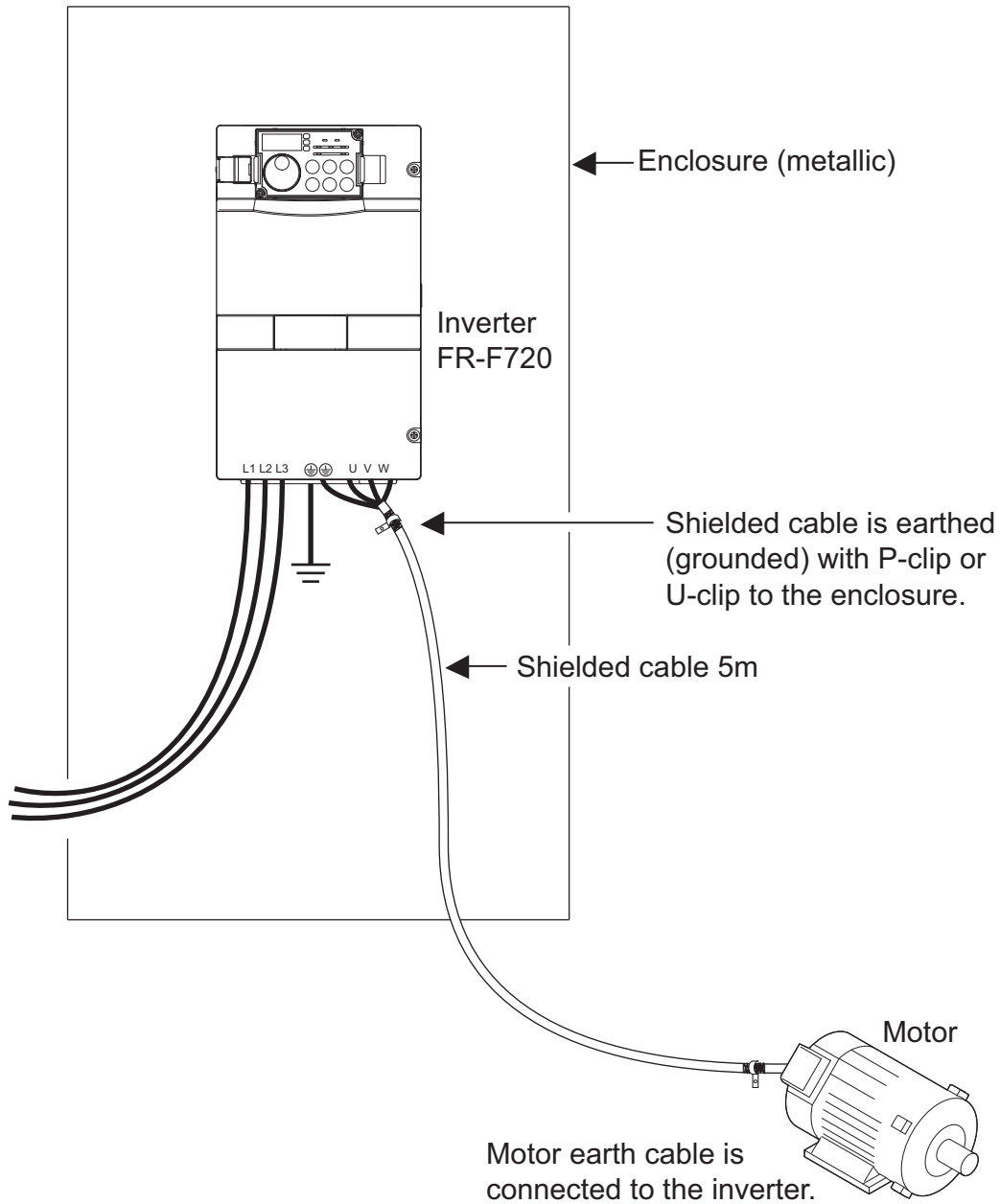

<<Measurement result>>

- FR-F720-1.5K

©Conducted interference

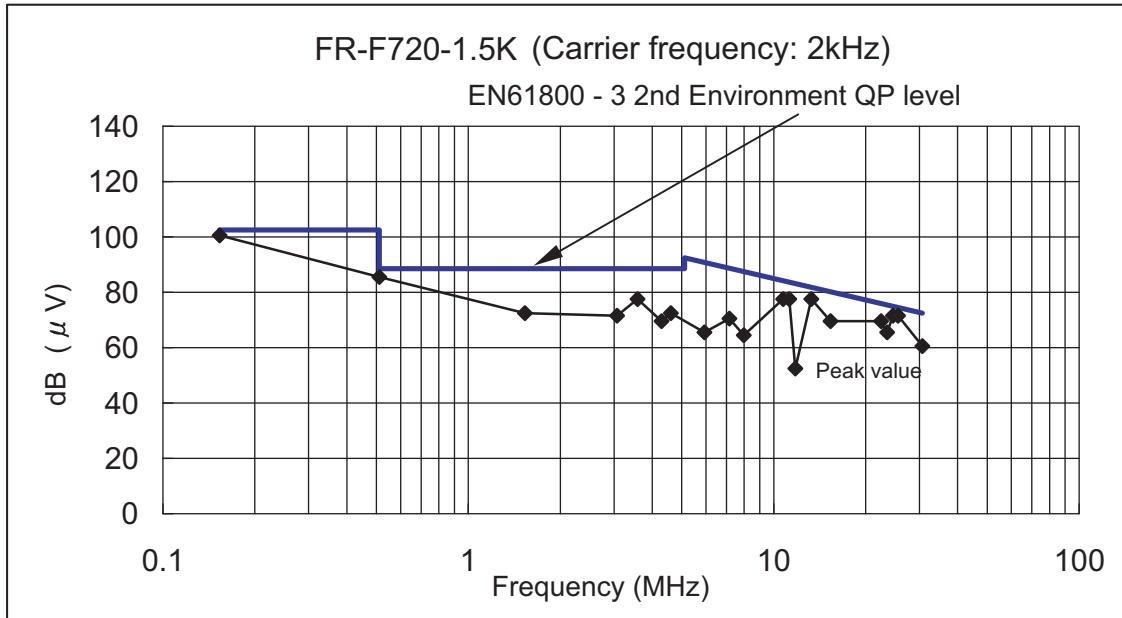

(Note) The QP value will not exceed the peak value.

©Radiated interference (10m site)

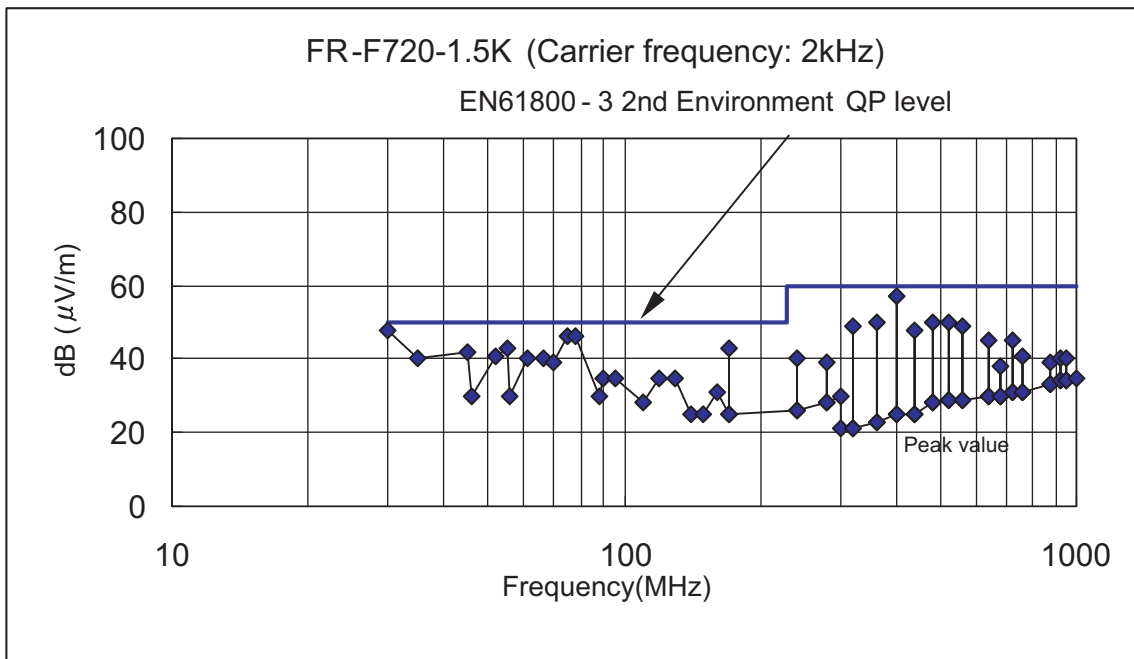

(Note) The QP value will not exceed the peak value.

• FR-F720-5.5K

© Conducted interference

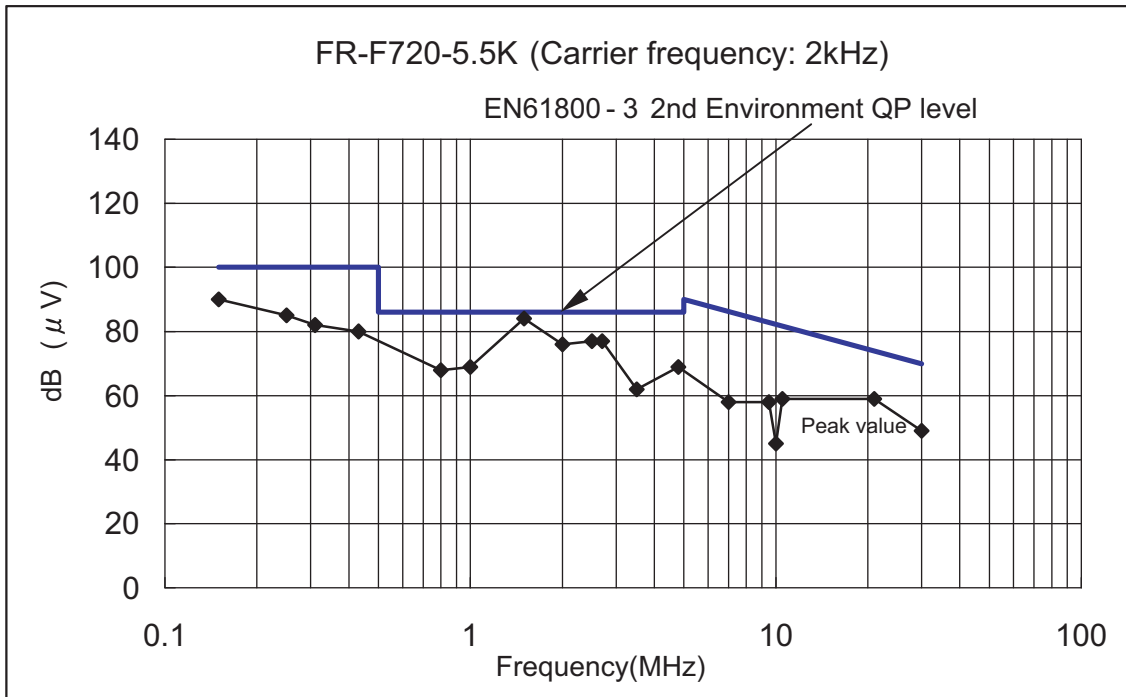

(Note) The QP value will not exceed the peak value.

© Radiated interference (10m site)

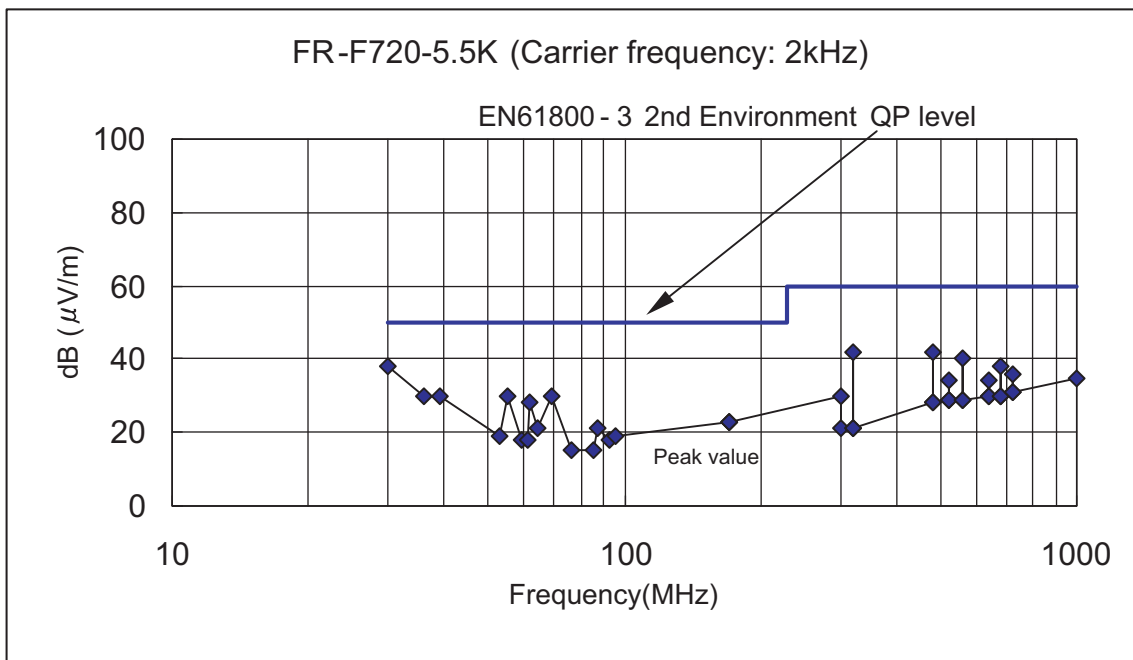

(Note) The QP value will not exceed the peak value.

• FR-F720-11K

© Conducted interference

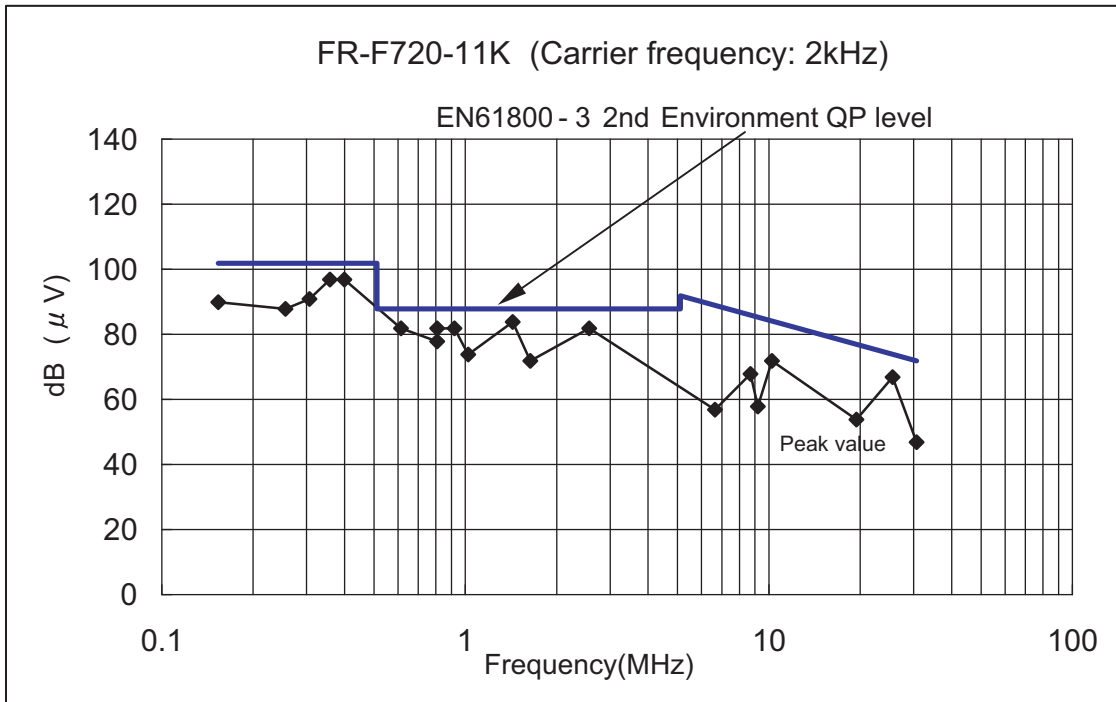

(Note) The QP value will not exceed the peak value.

© Radiated interference (10m site)

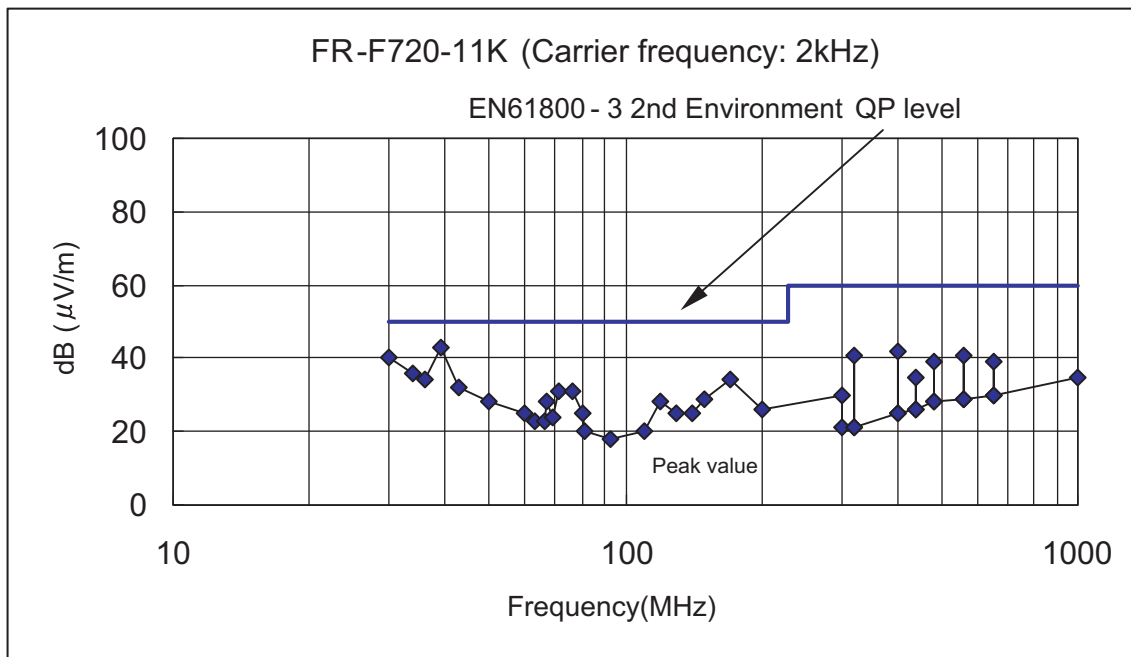

(Note) The QP value will not exceed the peak value.

• FR-F720-15K

© Conducted interference

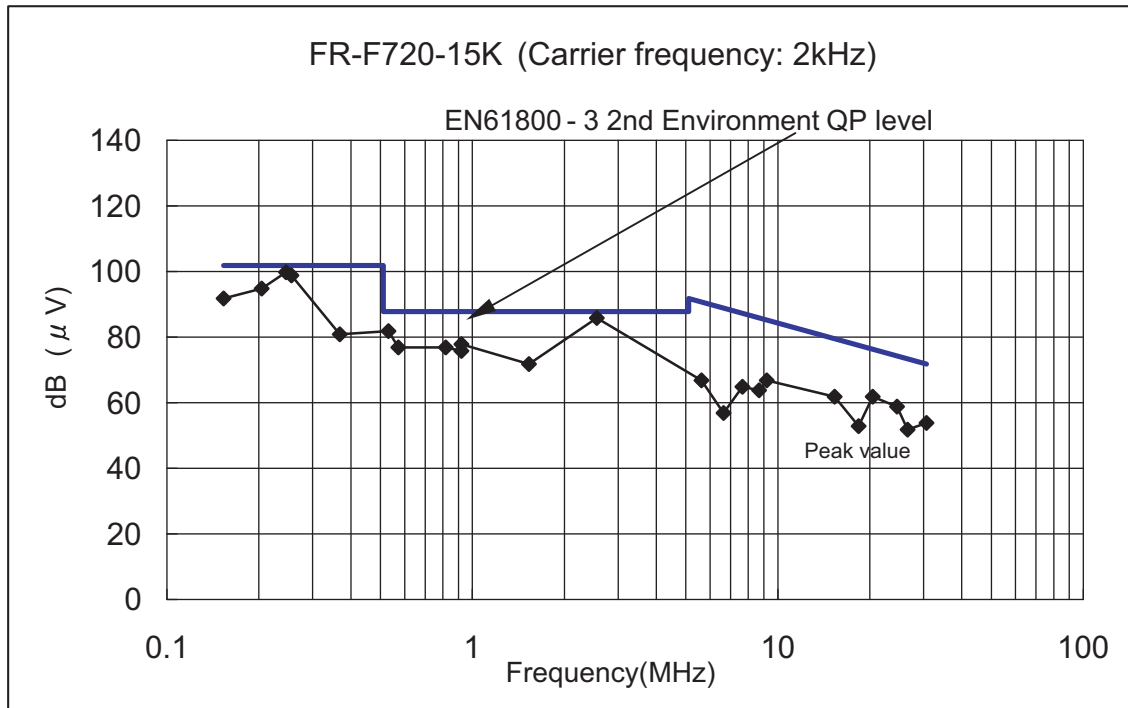

(Note) The QP value will not exceed the peak value.

© Radiated interference (10m site)

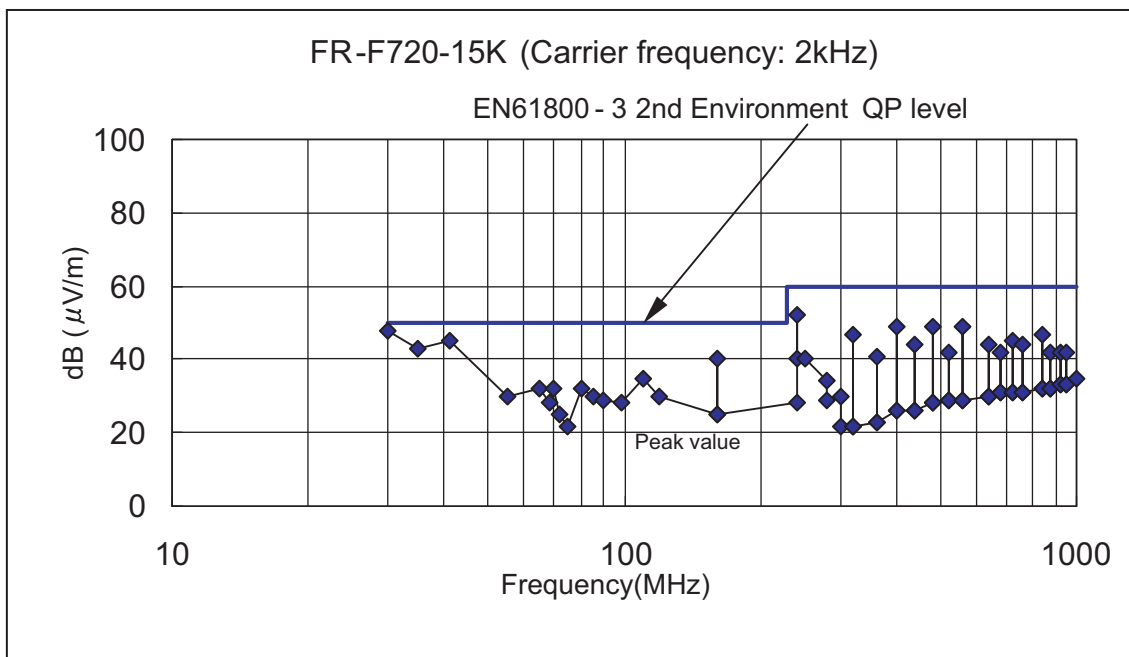

(Note) The QP value will not exceed the peak value.

• FR-F720-30K

© Conducted interference

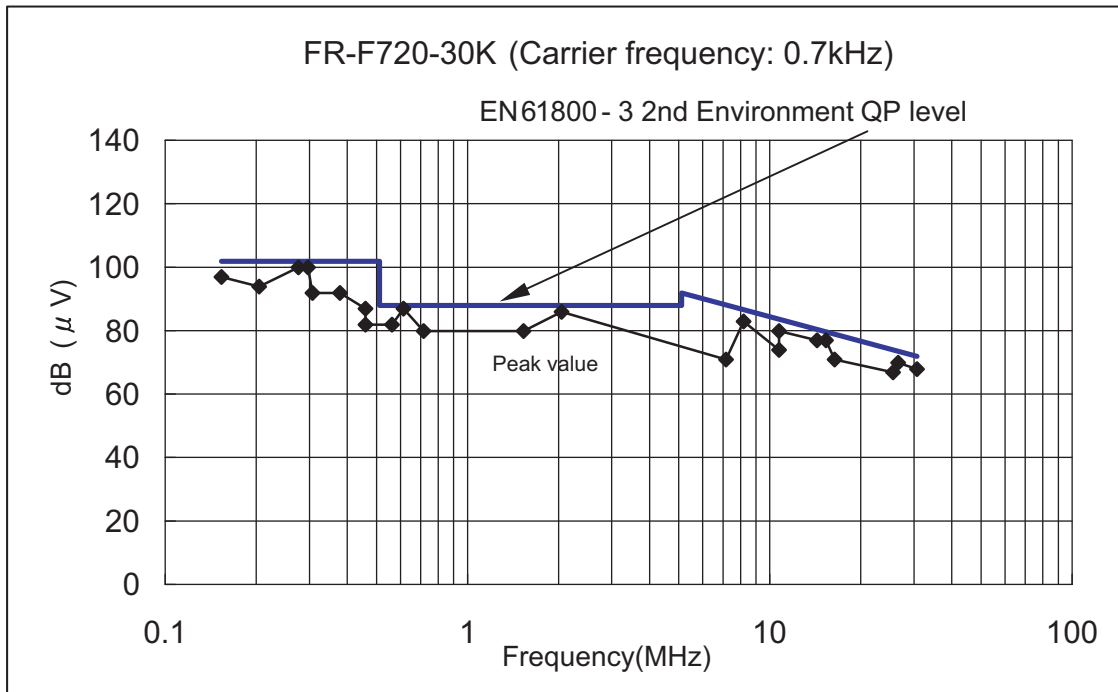

(Note) The QP value will not exceed the peak value.

© Radiated interference (10m site)

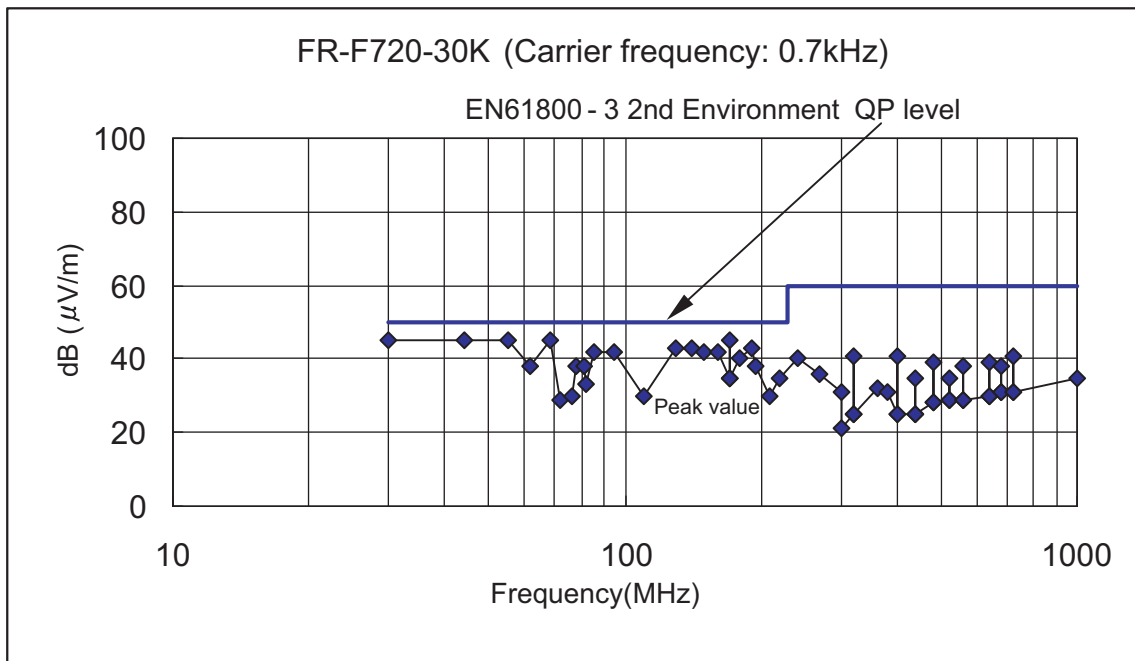

(Note) The QP value will not exceed the peak value.



• FR-F720-55K

© Conducted interference

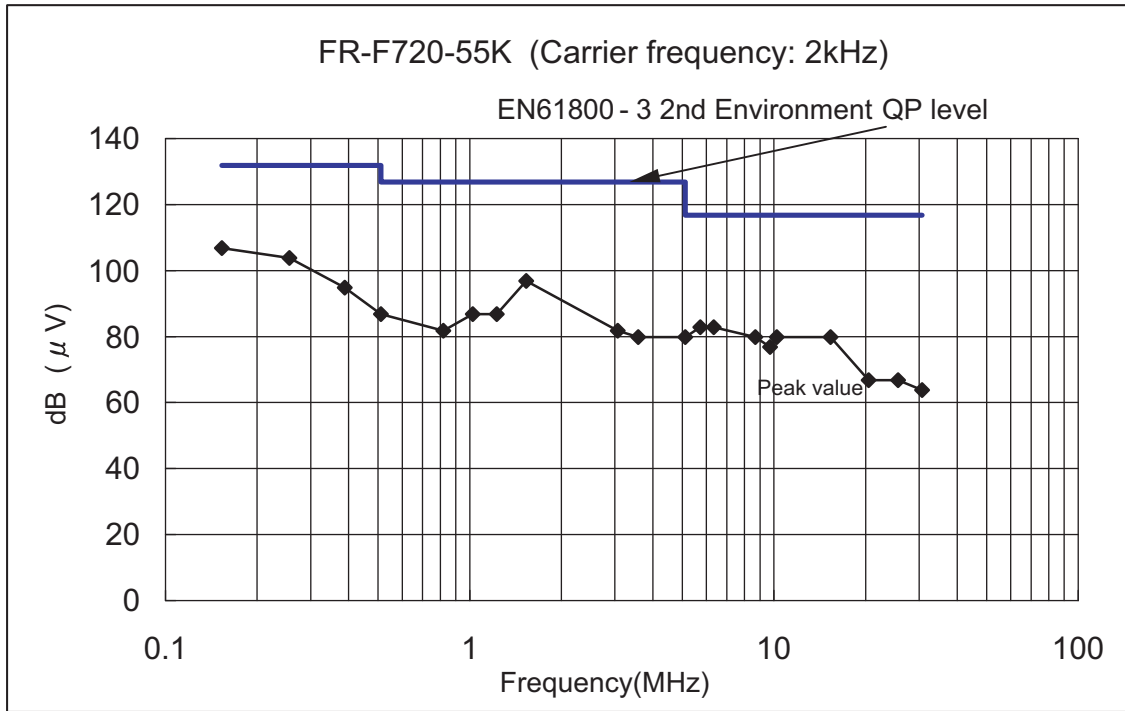

(Note) The QP value will not exceed the peak value.

© Radiated interference (10m site)

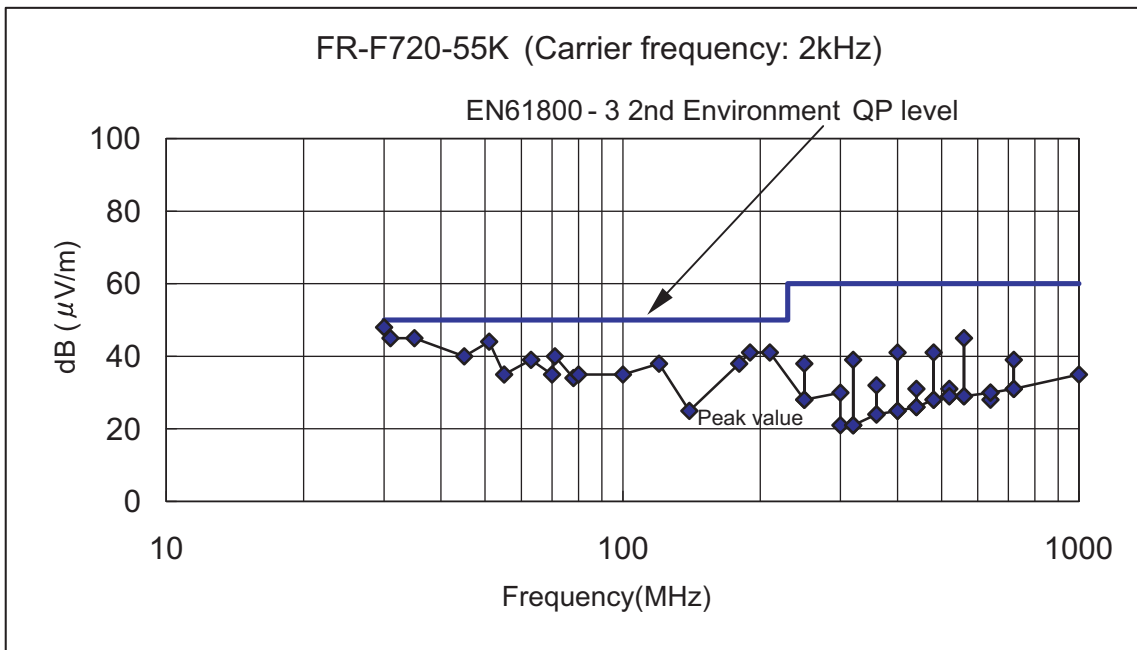

(Note) The QP value will not exceed the peak value.

• FR-F720-110K

© Conducted interference

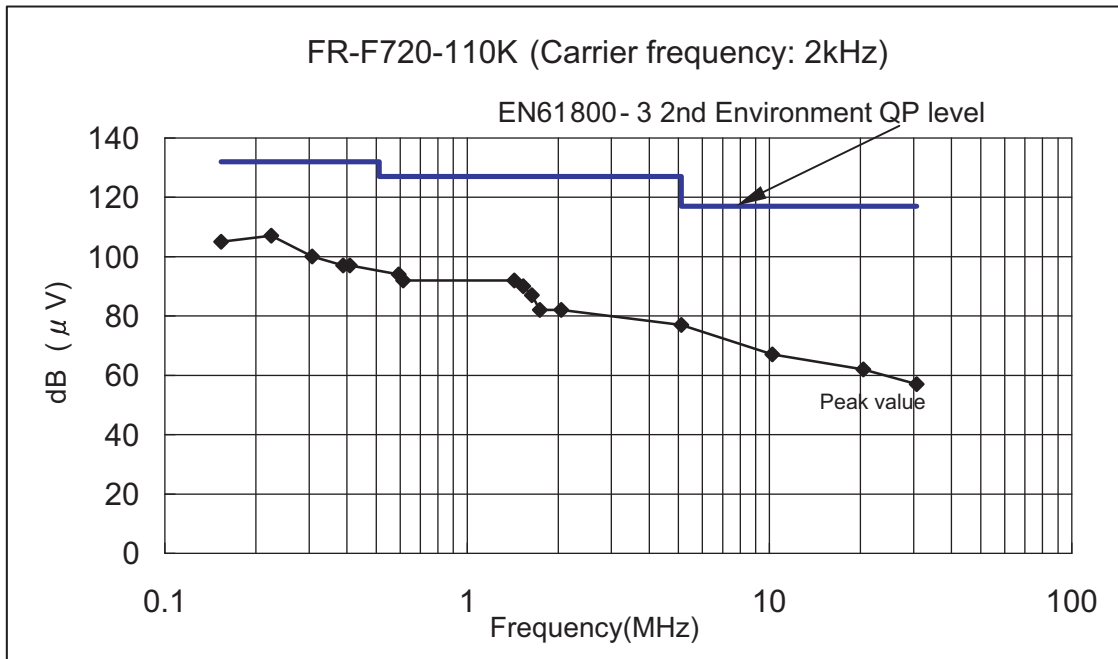

(Note) The QP value will not exceed the peak value.

© Radiated interference (10m site)

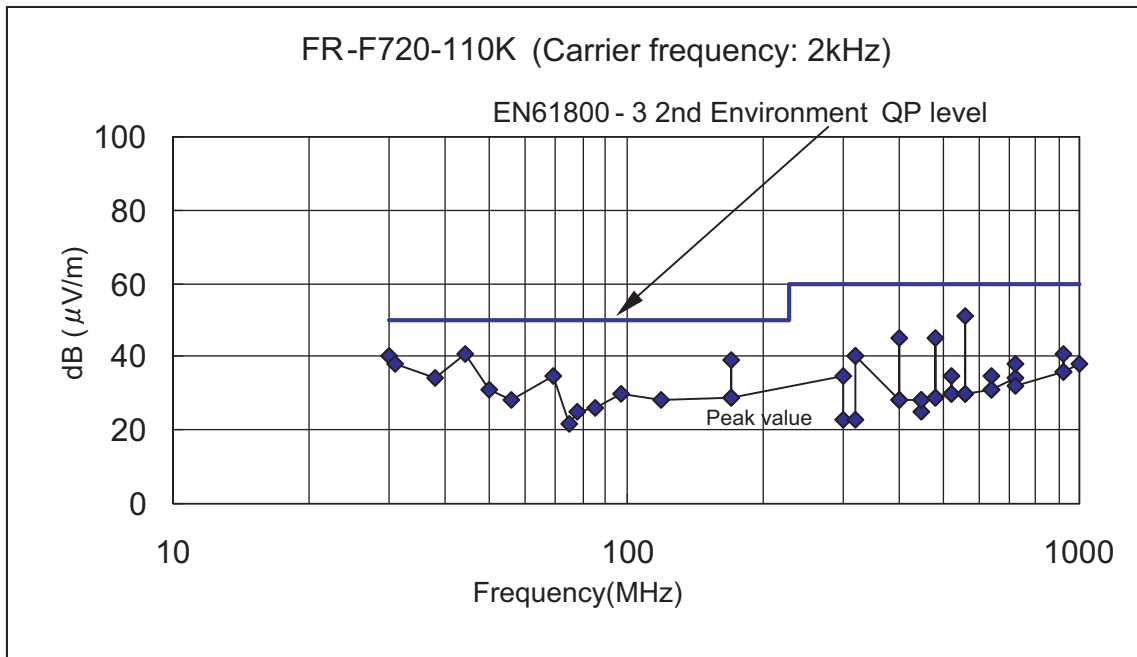

(Note) The QP value will not exceed the peak value.

# FR-F740

## <<Conditions>>

This inverter conforms with the product standard of EN61800-3.

Measurement was conducted according to the conditions of the product standard of EN61800-3 2nd environment.

Output wire length: 5m

Operation frequency: 30Hz

Output cable: Shielded cable

Carrier frequency: Refer to the each graph

Enclosure: No-door type

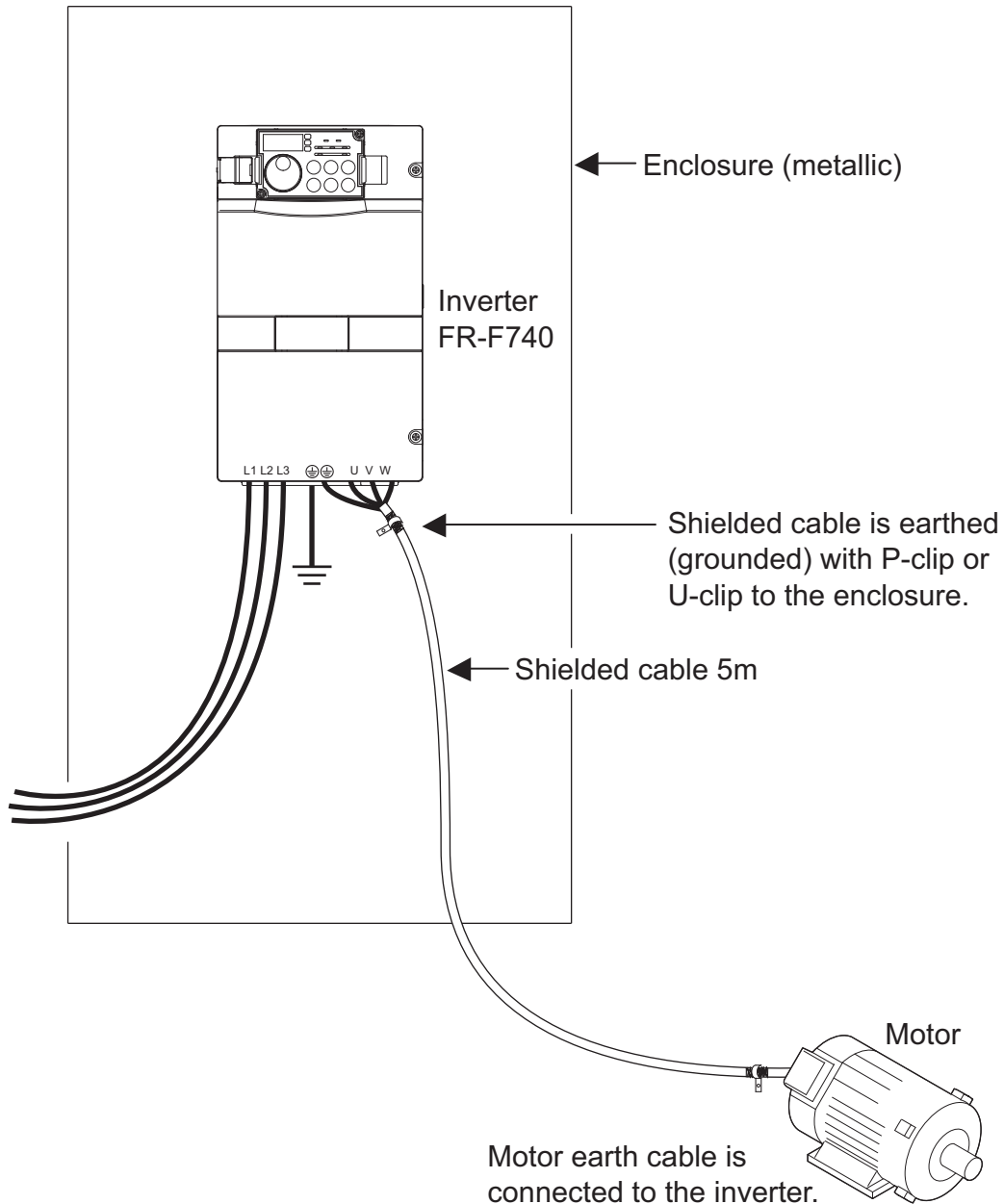

<<Measurement result>>

- FR-F740-5.5K

© Conducted interference

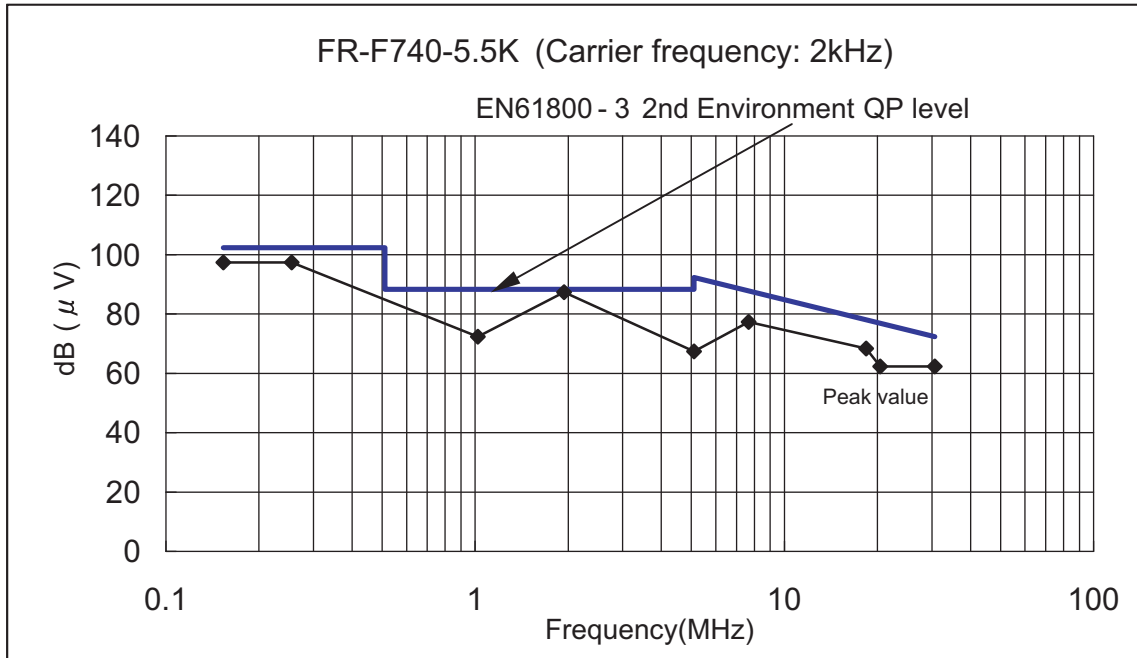

(Note) The QP value will not exceed the peak value.

© Radiated interference (10m site)

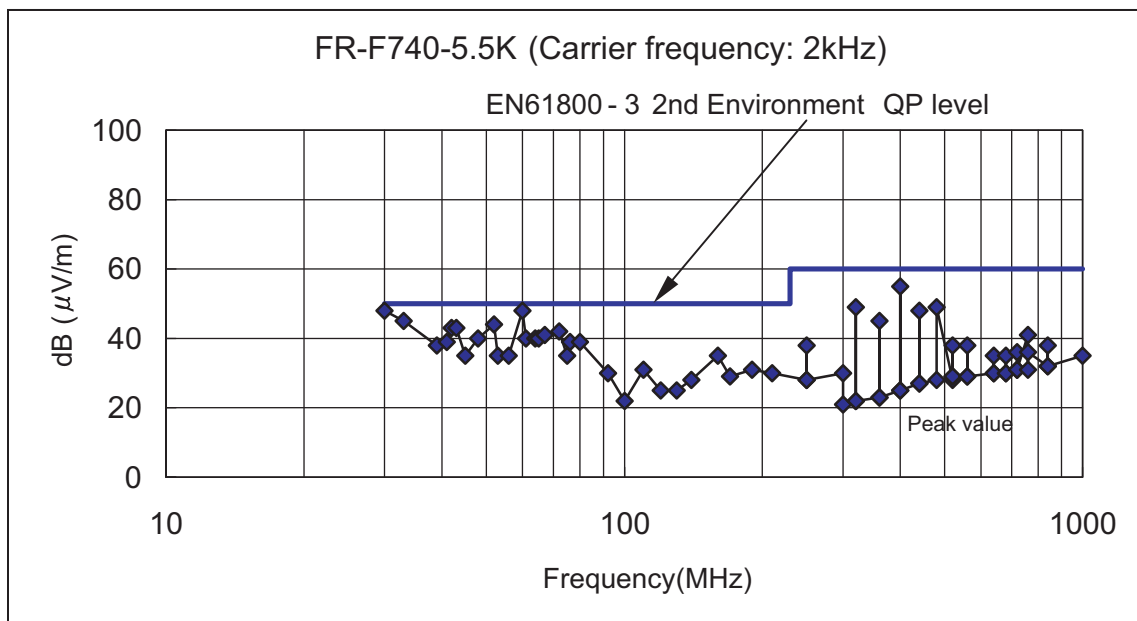

(Note) The QP value will not exceed the peak value.

• FR-F740-11K

© Conducted interference

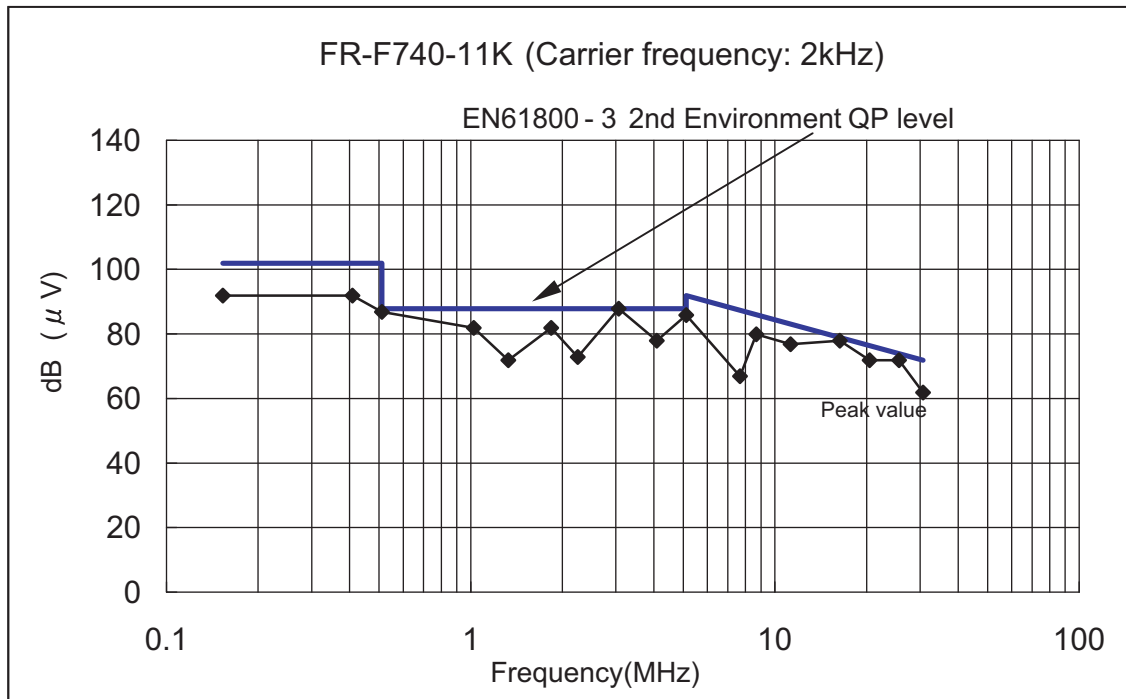

(Note) The QP value will not exceed the peak value.

© Radiated interference (10m site)

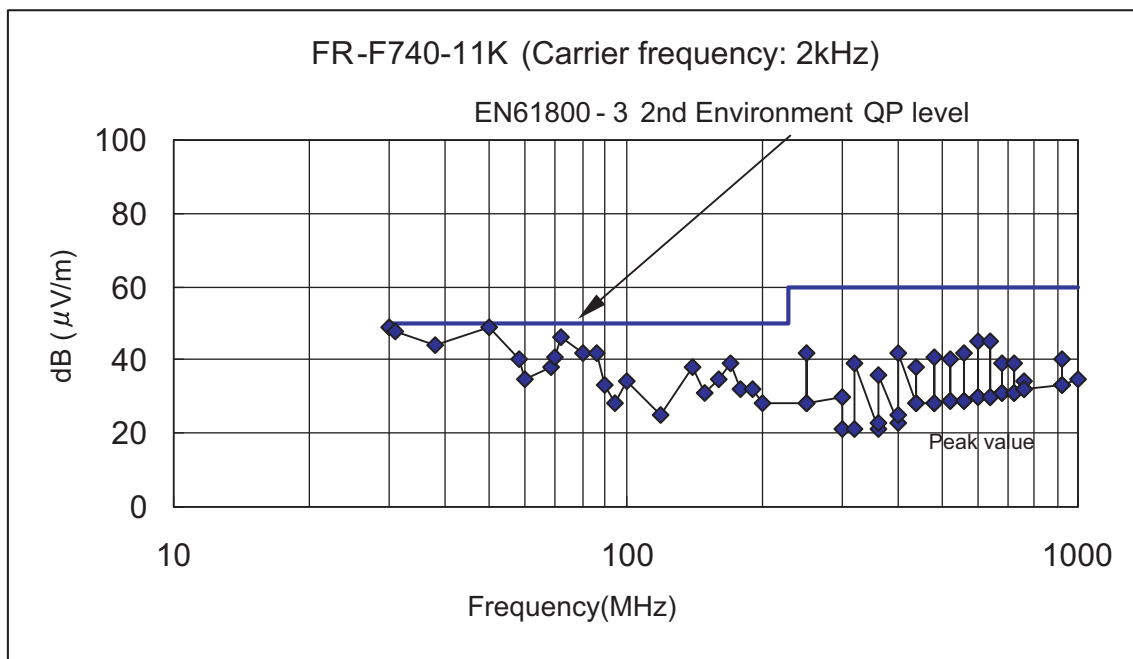

(Note) The QP value will not exceed the peak value.

• FR-F740-18.5K

© Conducted interference

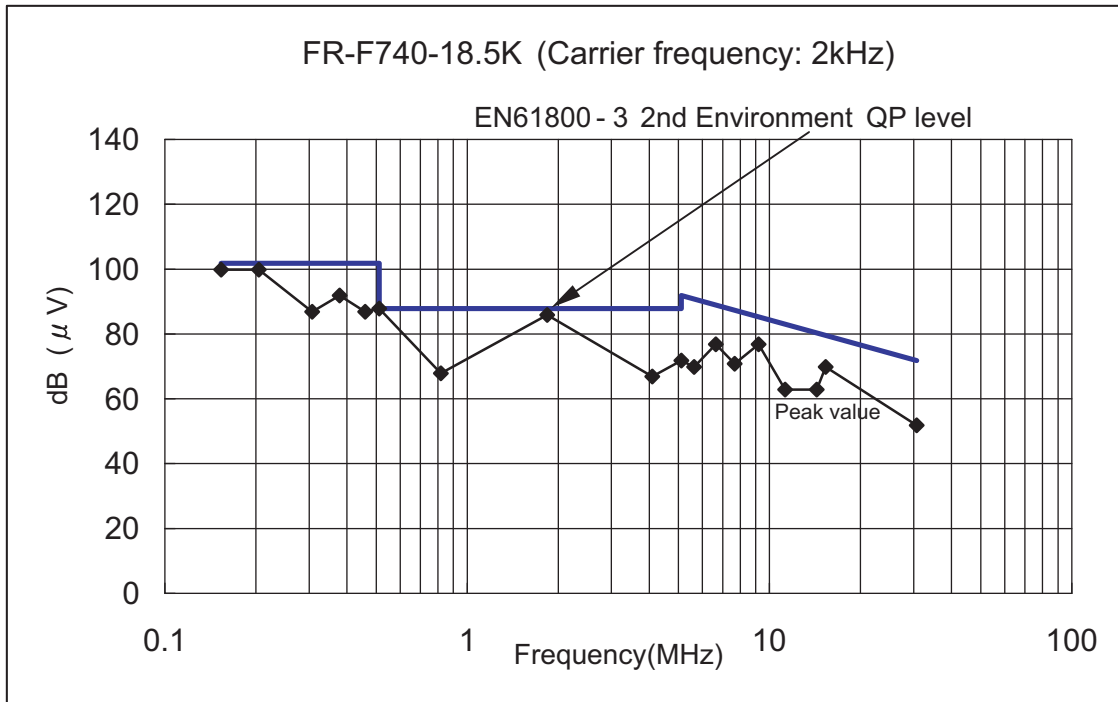

(Note) The QP value will not exceed the peak value.

© Radiated interference (10m site)

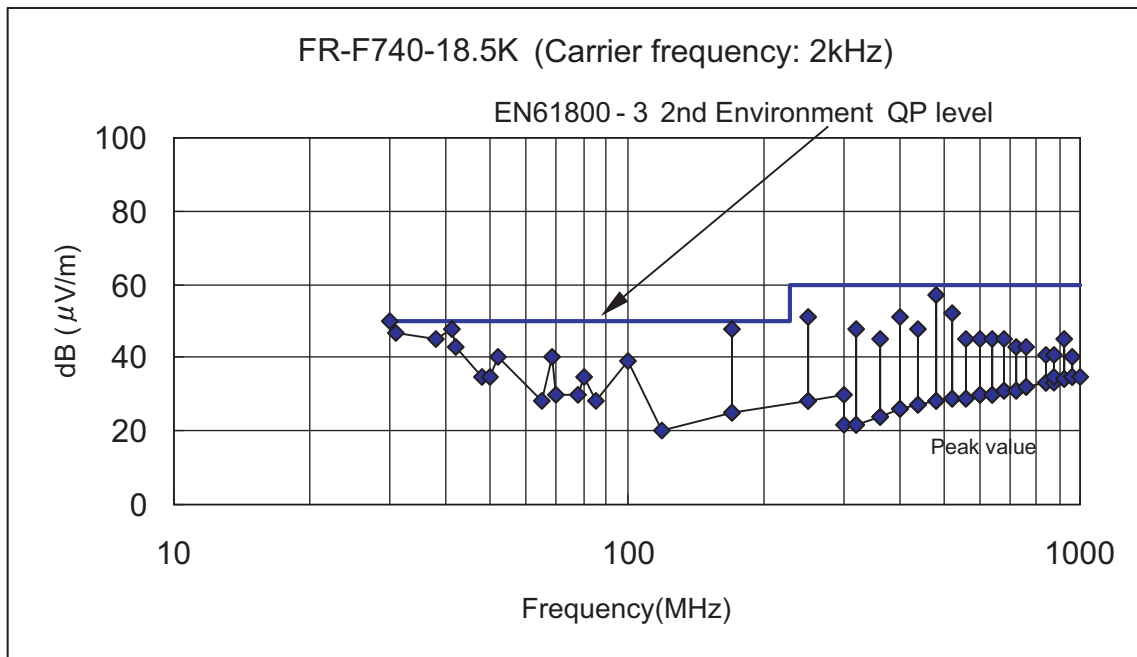

(Note) The QP value will not exceed the peak value.

• FR-F740-22K

© Conducted interference

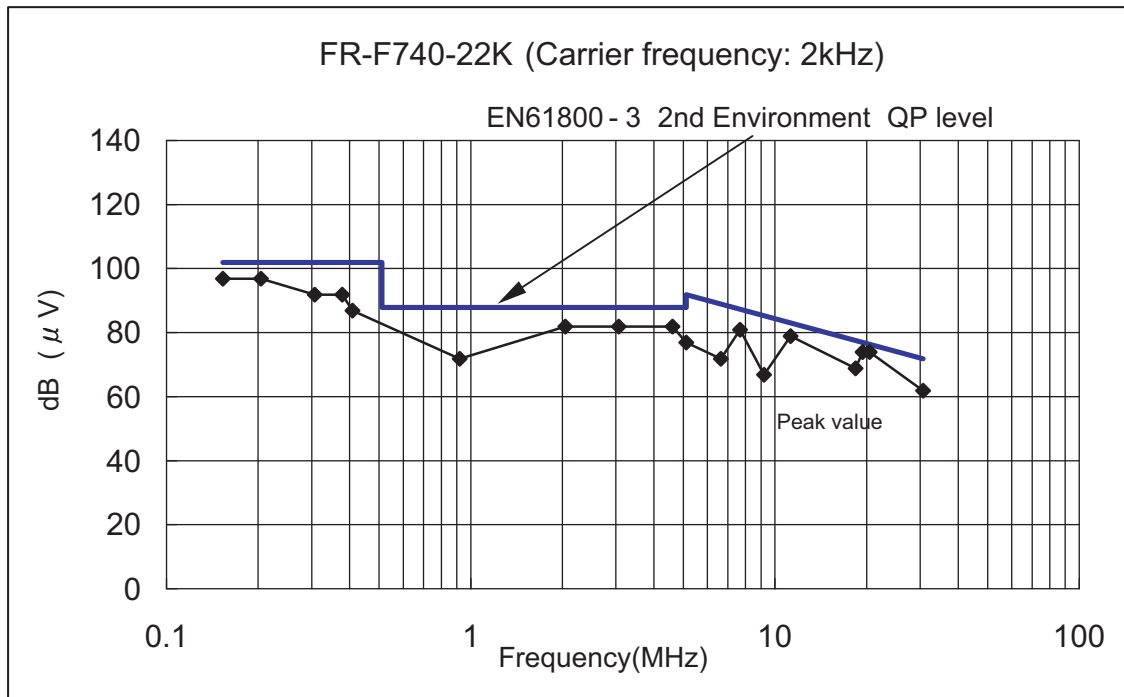

(Note) The QP value will not exceed the peak value.

© Radiated interference (10m site)

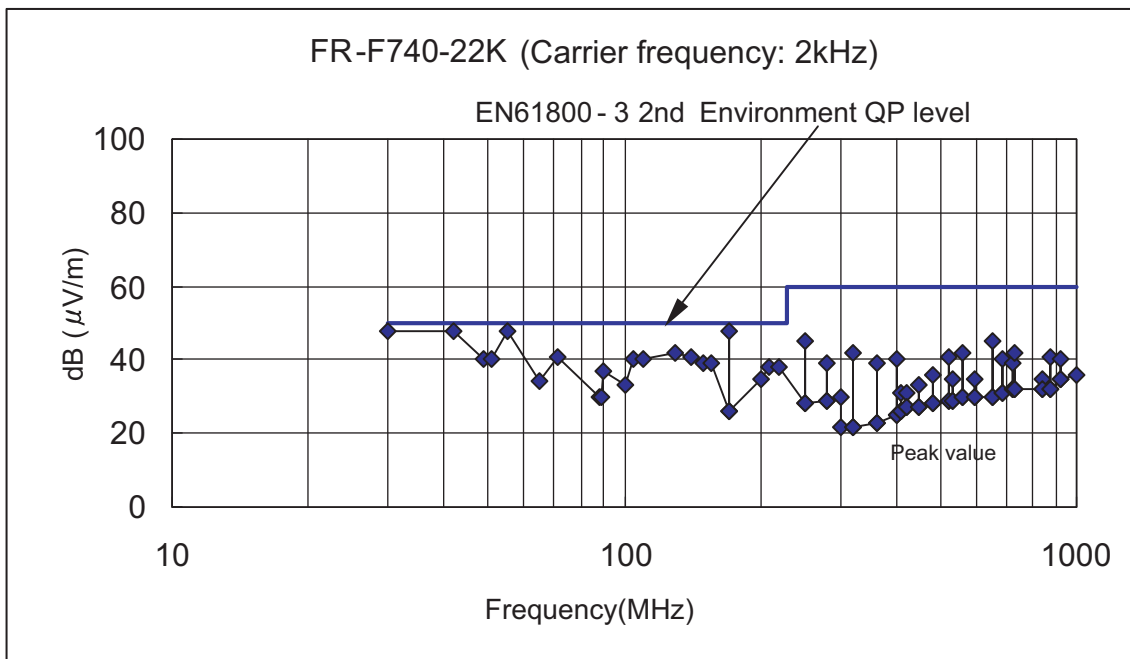

(Note) The QP value will not exceed the peak value.

• FR-F740-30K

© Conducted interference

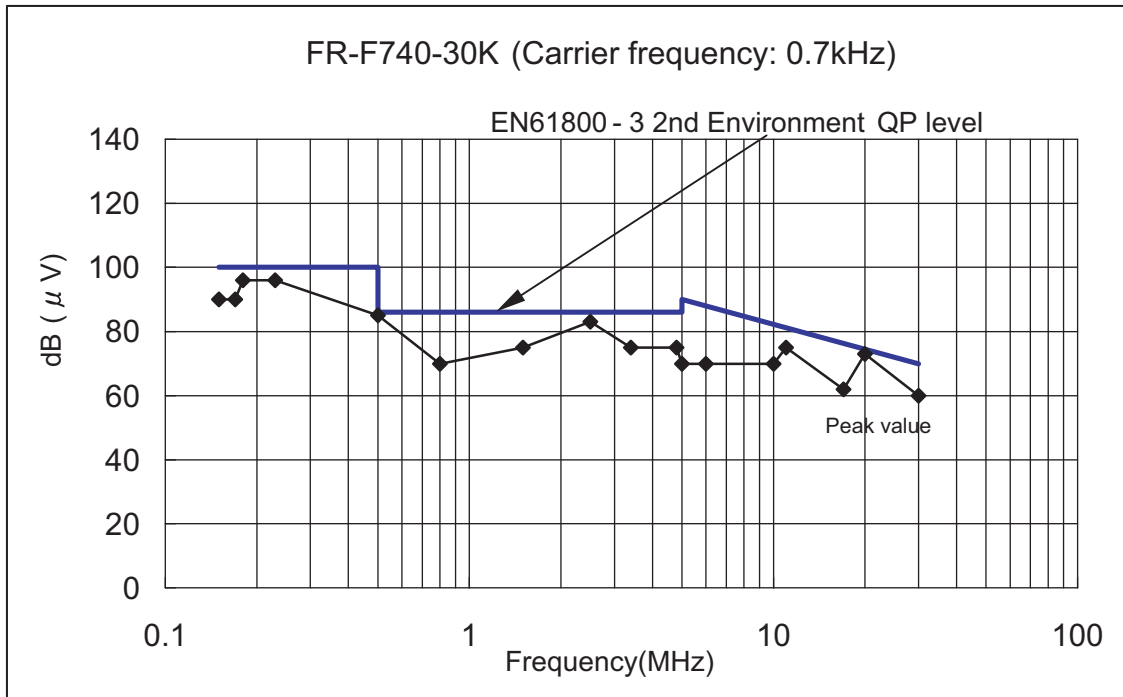

(Note) The QP value will not exceed the peak value.

© Radiated interference (10m site)

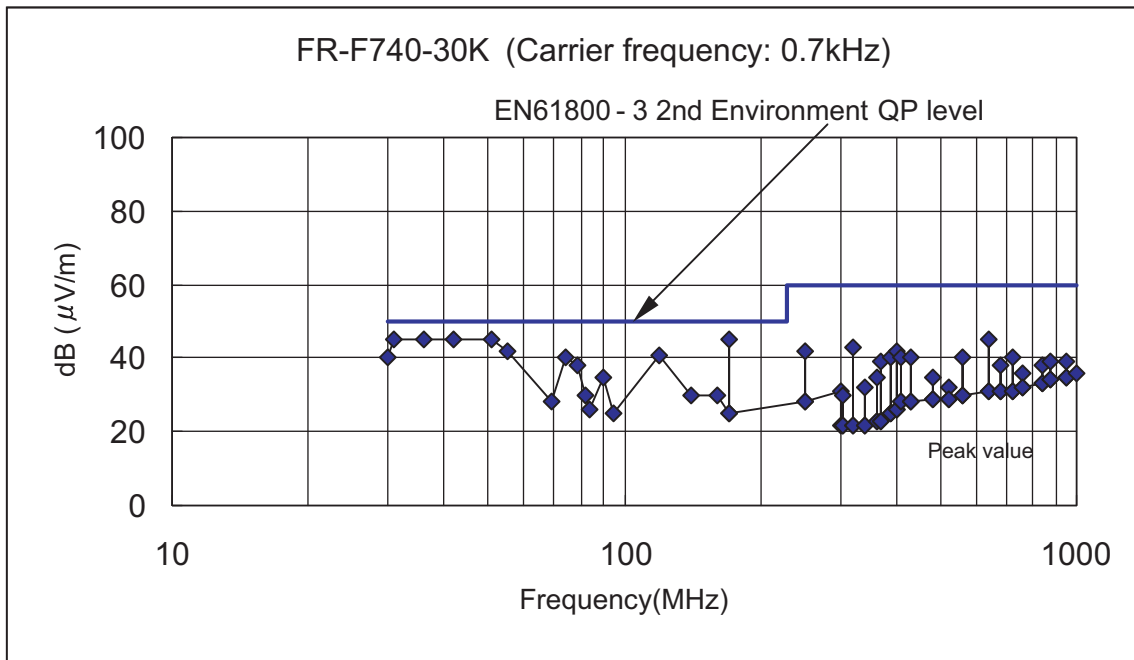

(Note) The QP value will not exceed the peak value.



• FR-F740-75K

© Conducted interference

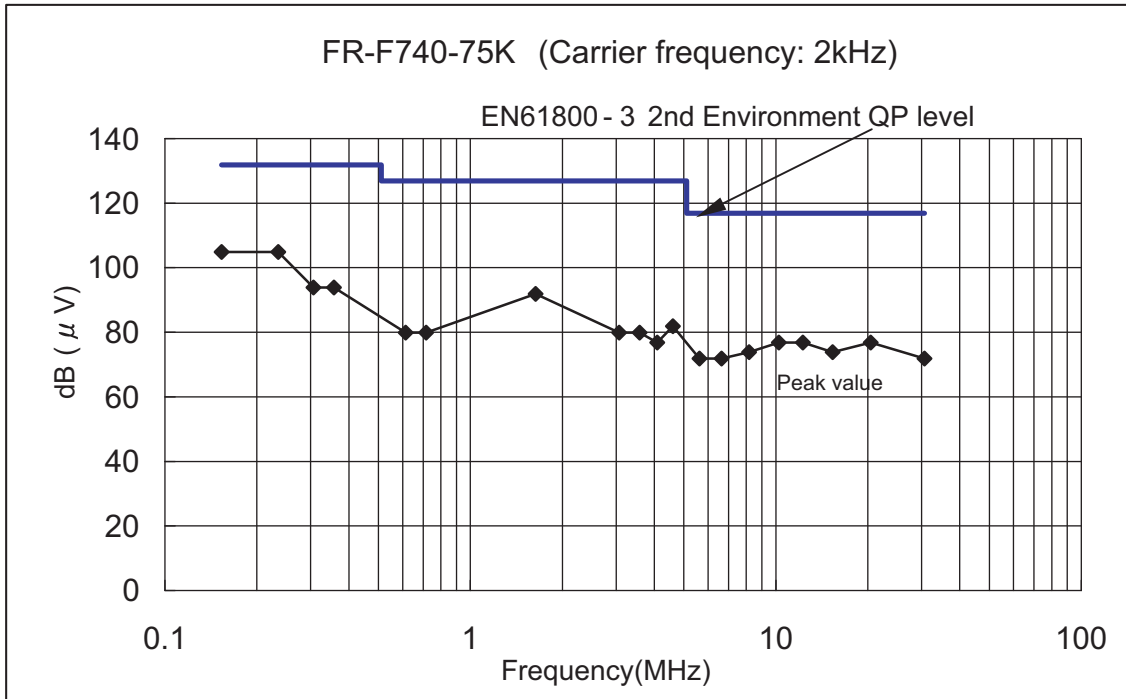

(Note) The QP value will not exceed the peak value.

© Radiated interference (10m site)

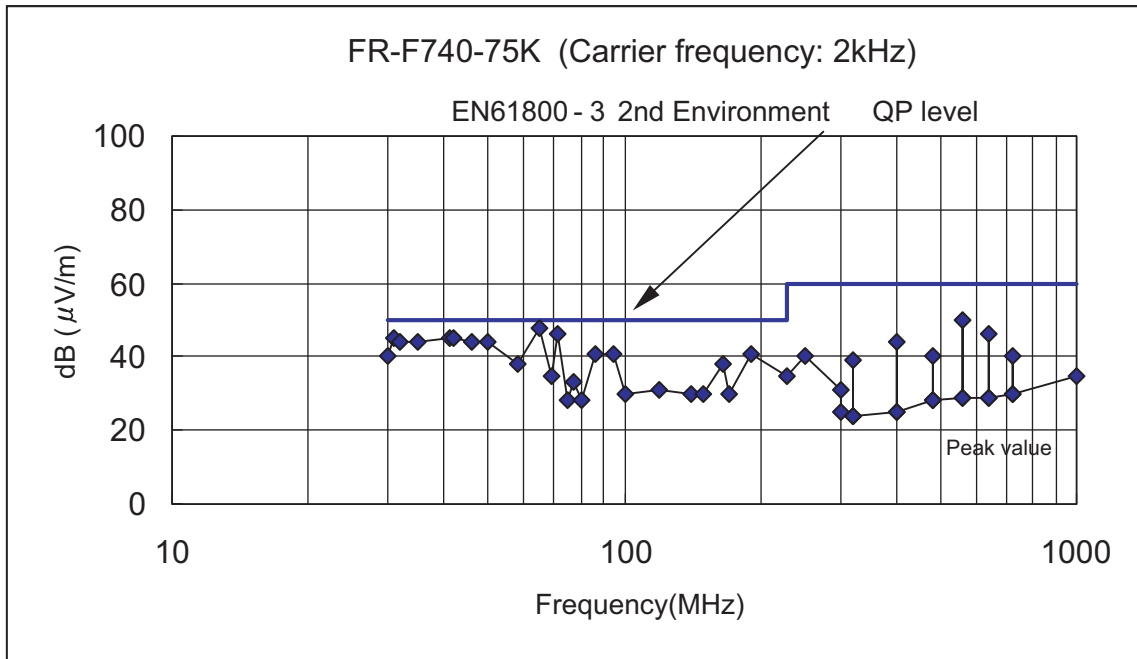

(Note) The QP value will not exceed the peak value.

• FR-F740-110K

© Conducted interference

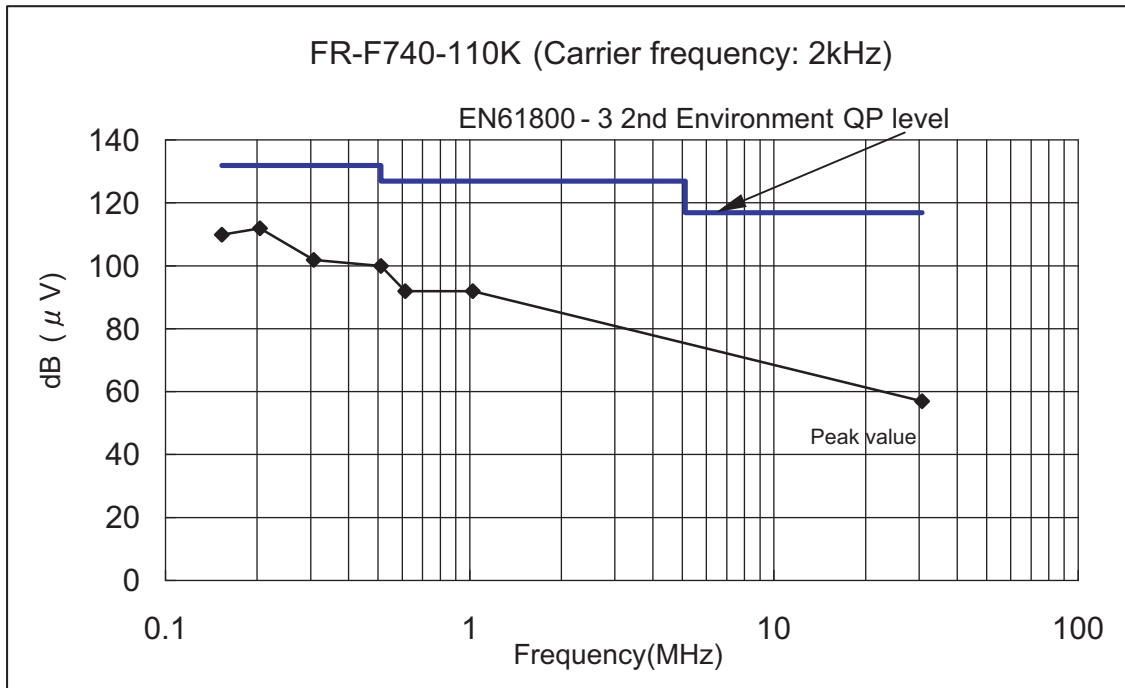

(Note) The QP value will not exceed the peak value.

© Radiated interference (10m site)

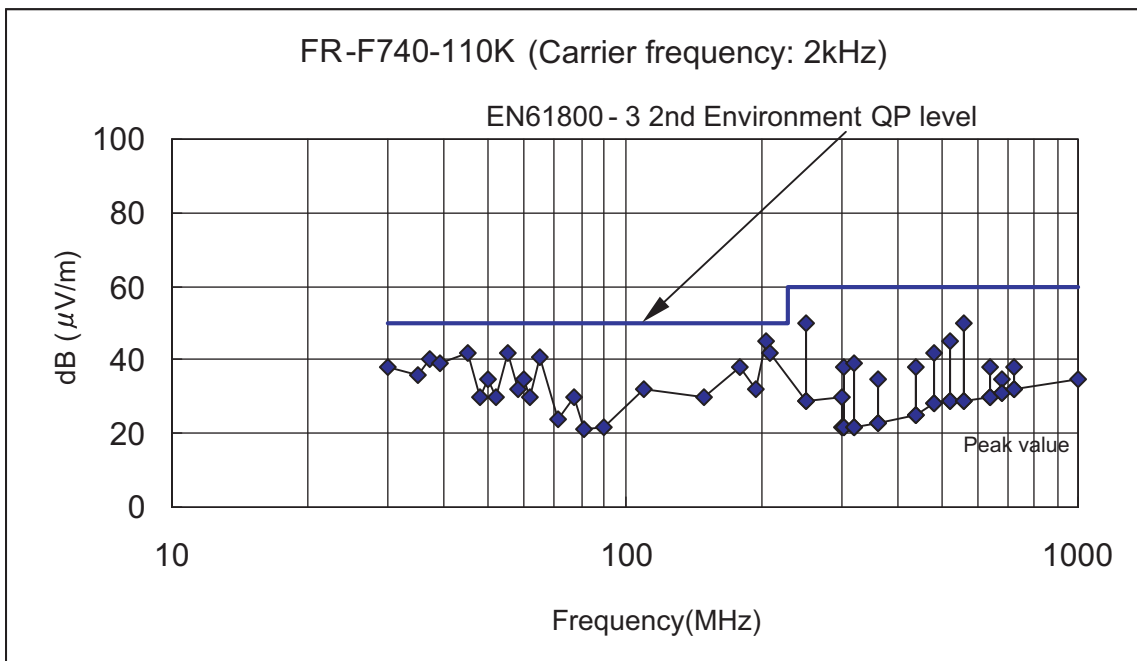

(Note) The QP value will not exceed the peak value.

• FR-F740-160K

© Conducted interference

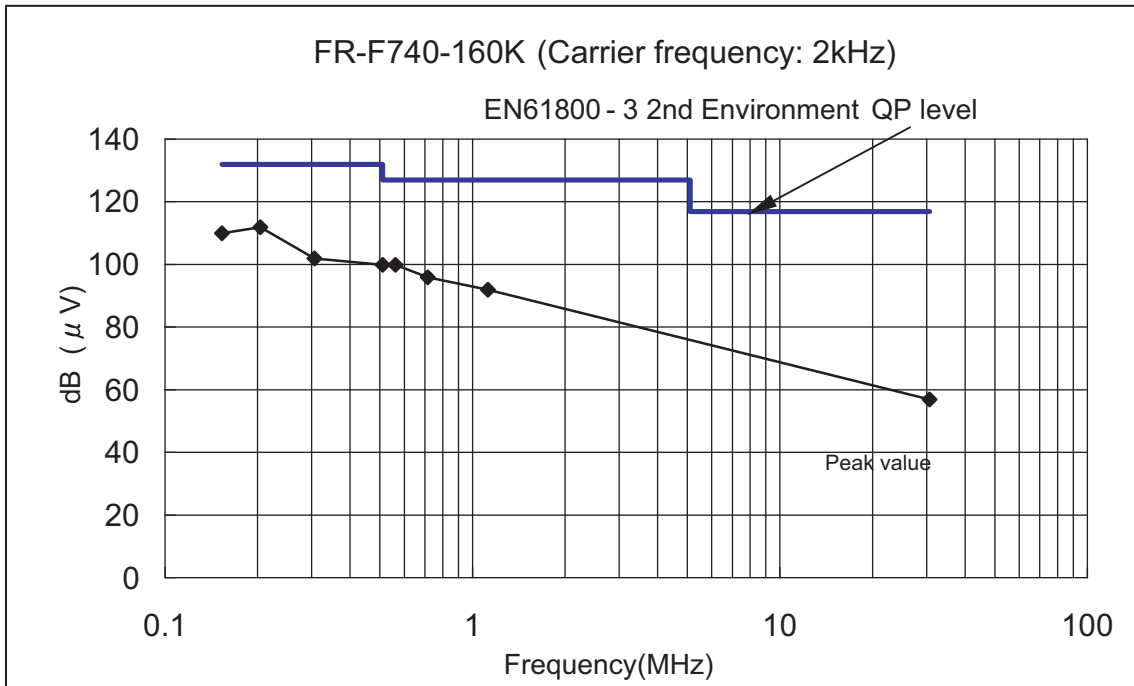

(Note) The QP value will not exceed the peak value.

© Radiated interference (10m site)

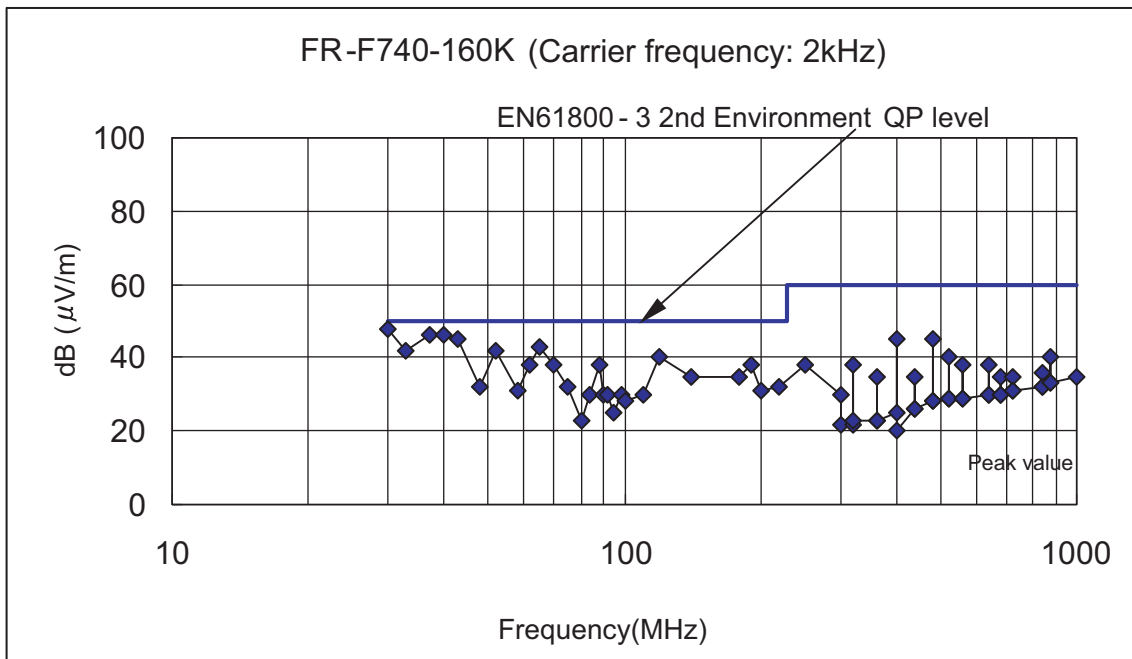

(Note) The QP value will not exceed the peak value.

• FR-F740-220K

© Conducted interference

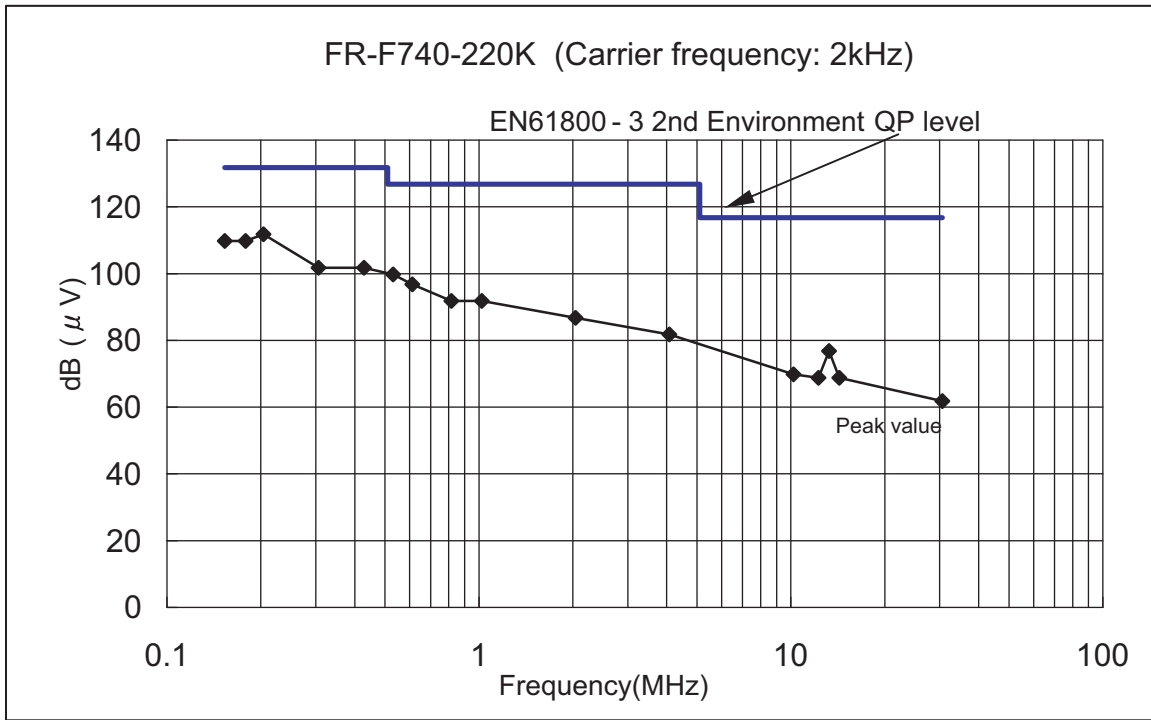

(Note) The QP value will not exceed the peak value.

© Radiated interference (10m site)

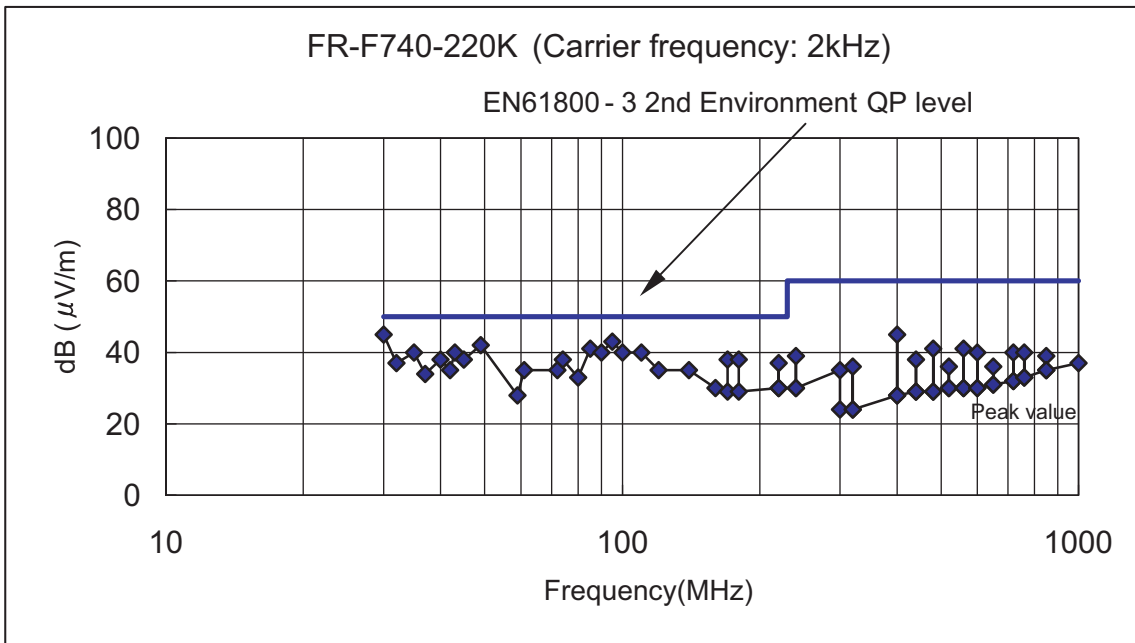

(Note) The QP value will not exceed the peak value.

• FR-F740-315K

© Conducted interference

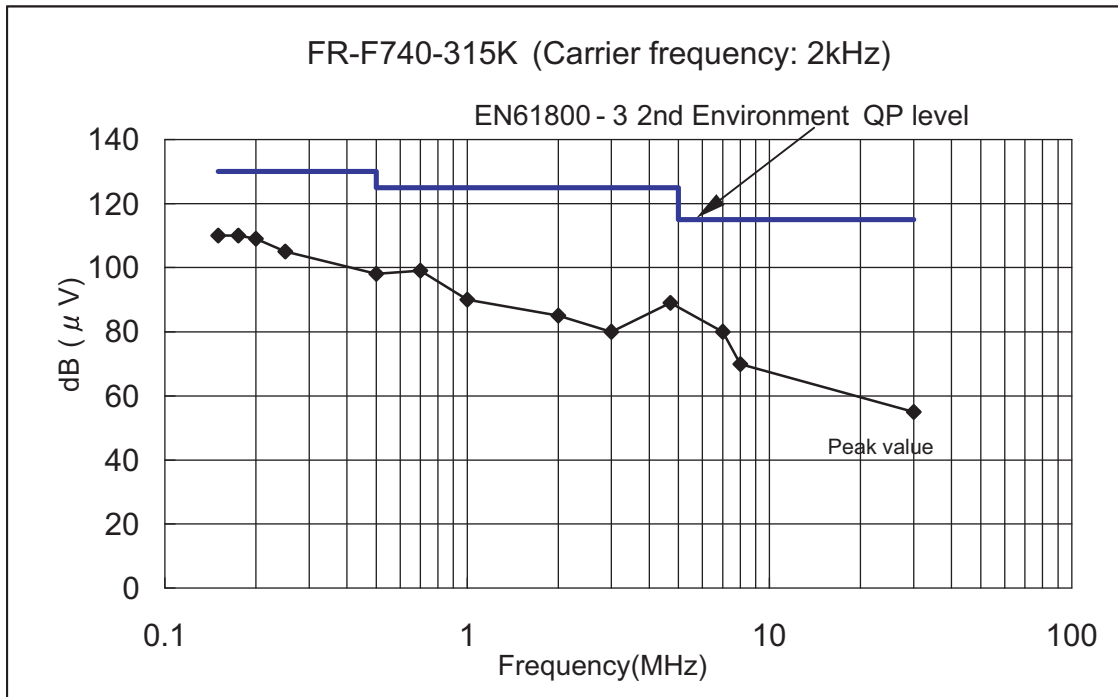

(Note) The QP value will not exceed the peak value.

© Radiated interference (10m site)

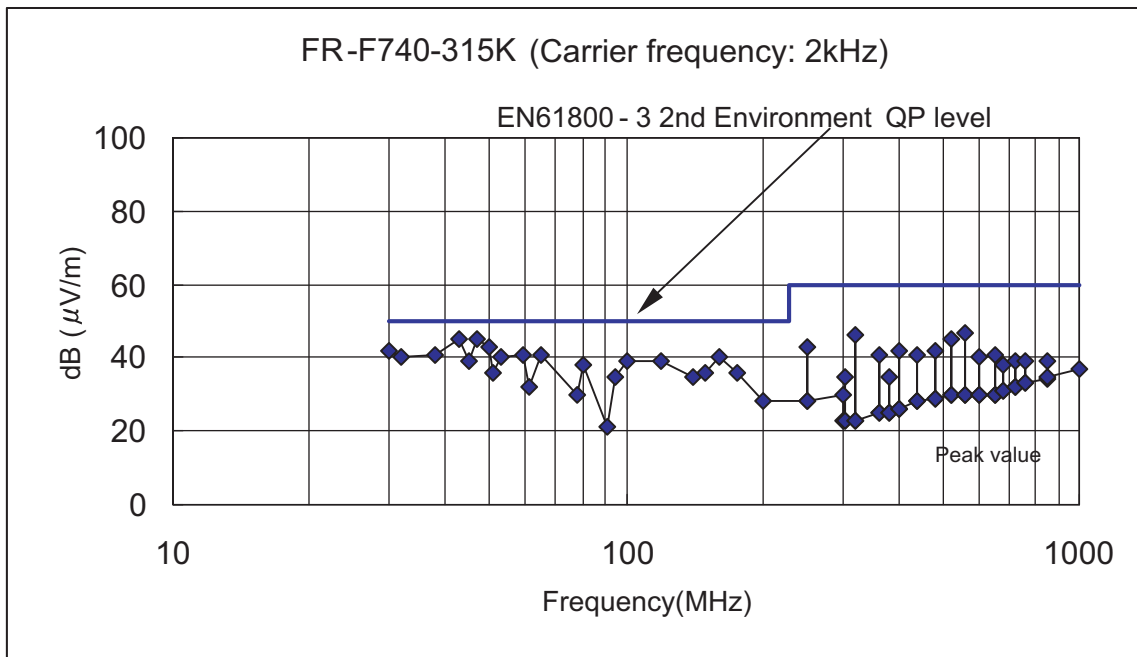

(Note) The QP value will not exceed the peak value.

• FR-F740-400K

© Conducted interference

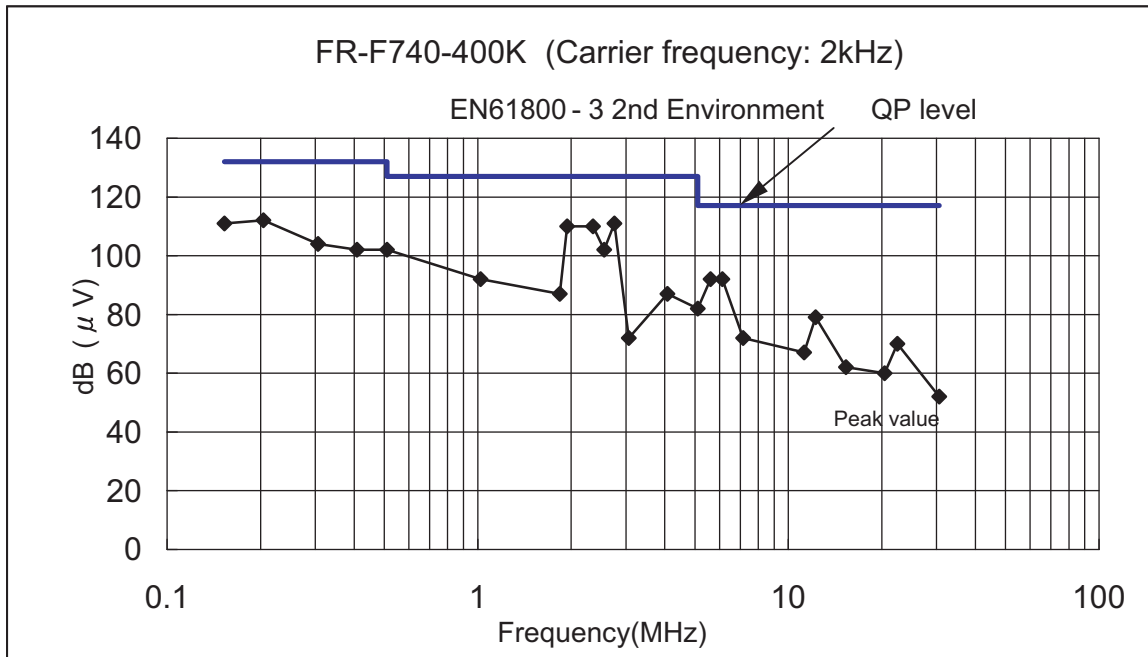

(Note) The QP value will not exceed the peak value.

© Radiated interference (10m site)

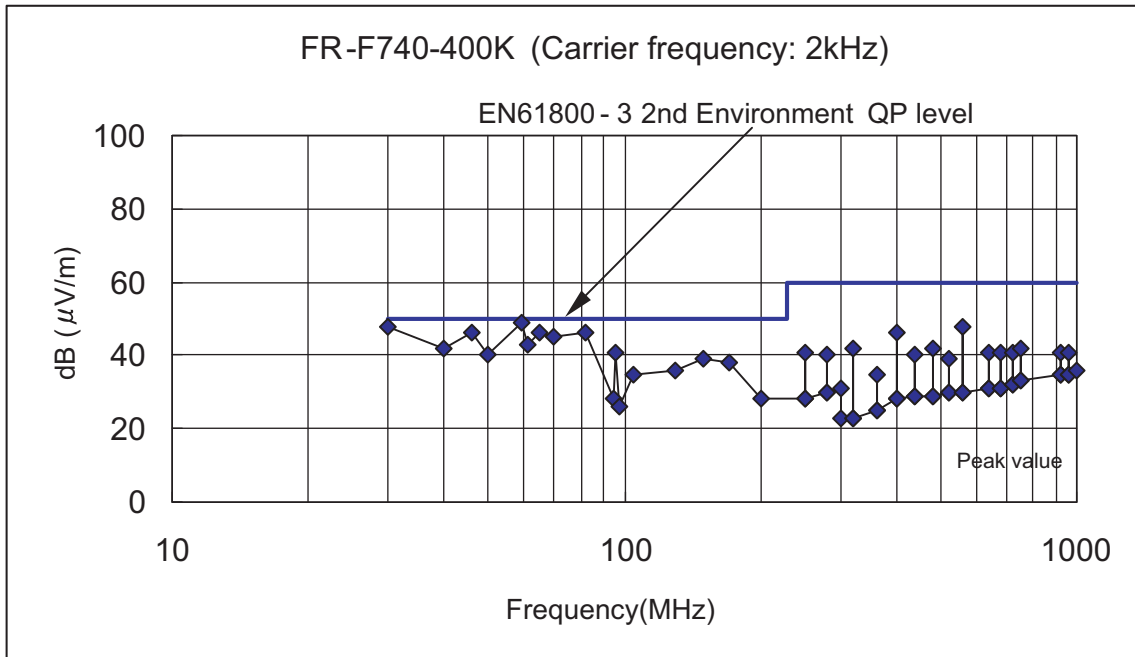

(Note) The QP value will not exceed the peak value.

# FR-E720

## <<Conditions>>

This inverter conforms with the product standard of EN61800-3.

Measurement was conducted according to the conditions of the product standard of EN61800-3 2nd environment.

Output wire length: 5m

Output cable: Shielded cable

Enclosure: No-door type

Operation frequency: 30Hz

Carrier frequency: Refer to the each graph

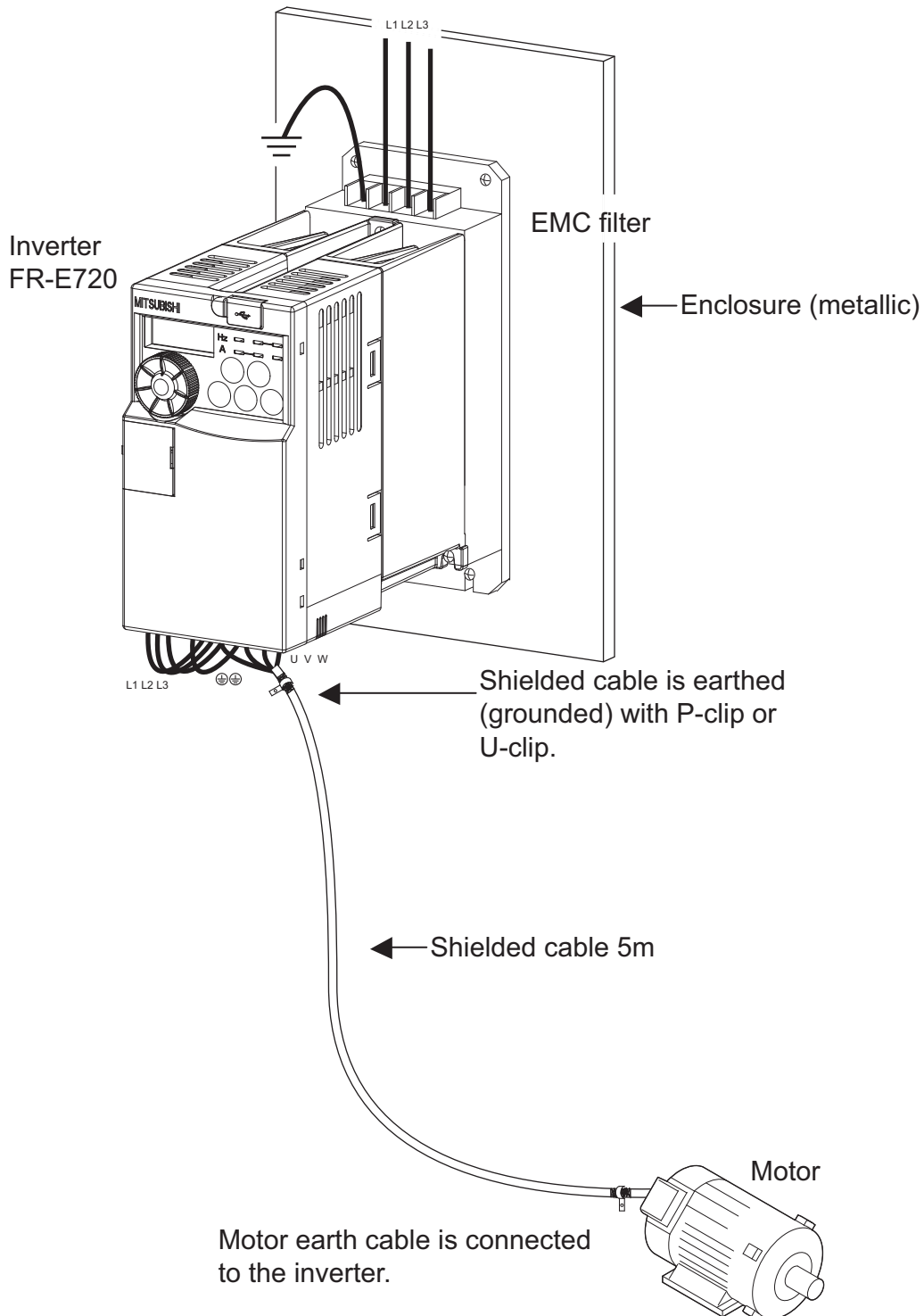

<<Measurement result>>

• FR-E720-0.75K, SF1306

◎ Conducted interference

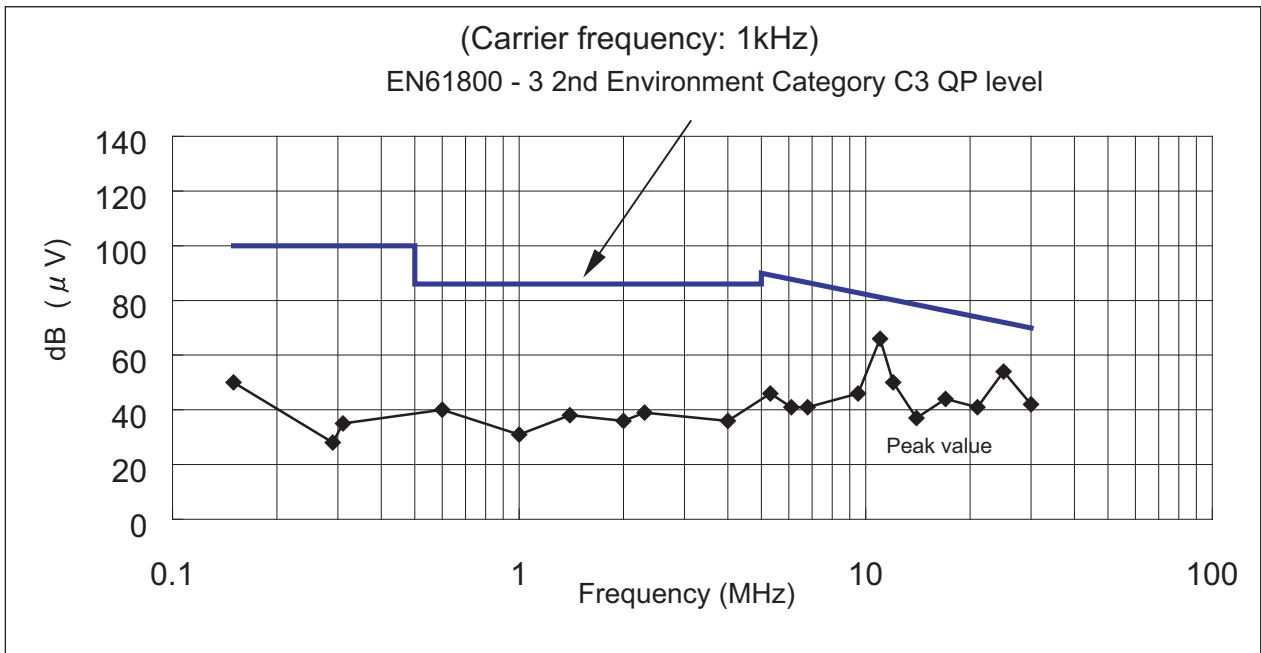

(Note) The QP value will not exceed the peak value.

◎ Radiated interference(10m site)

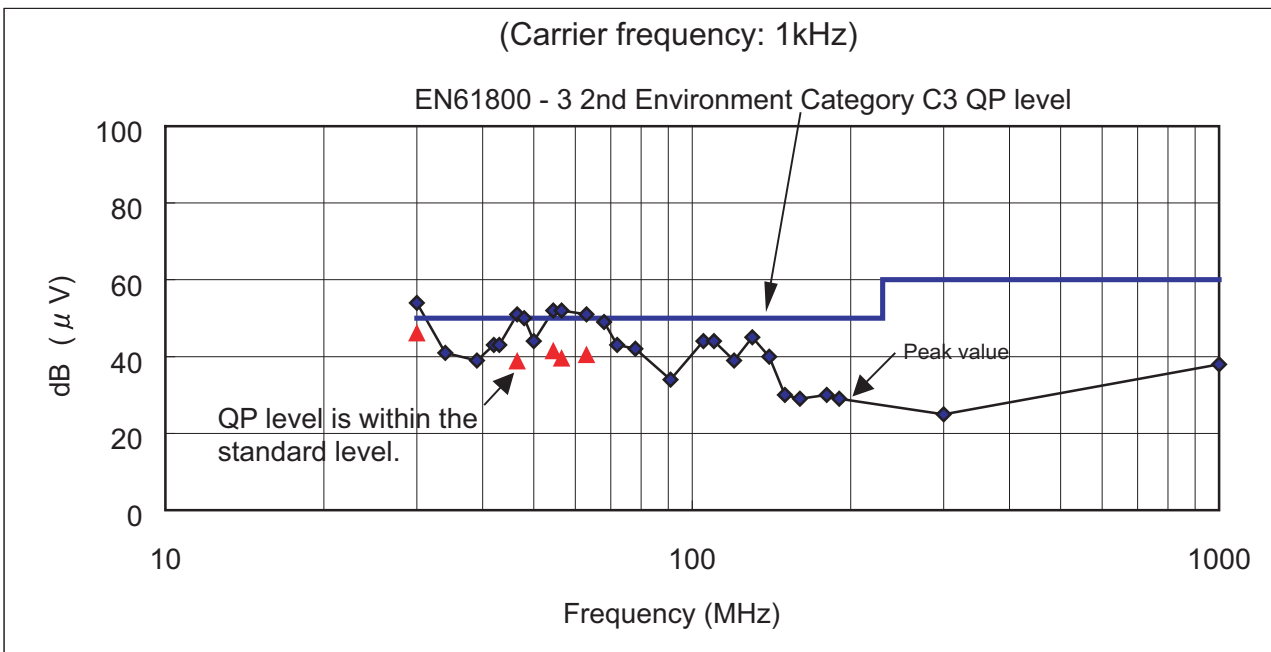

(Note) The QP value will not exceed the peak value.



© Conducted interference

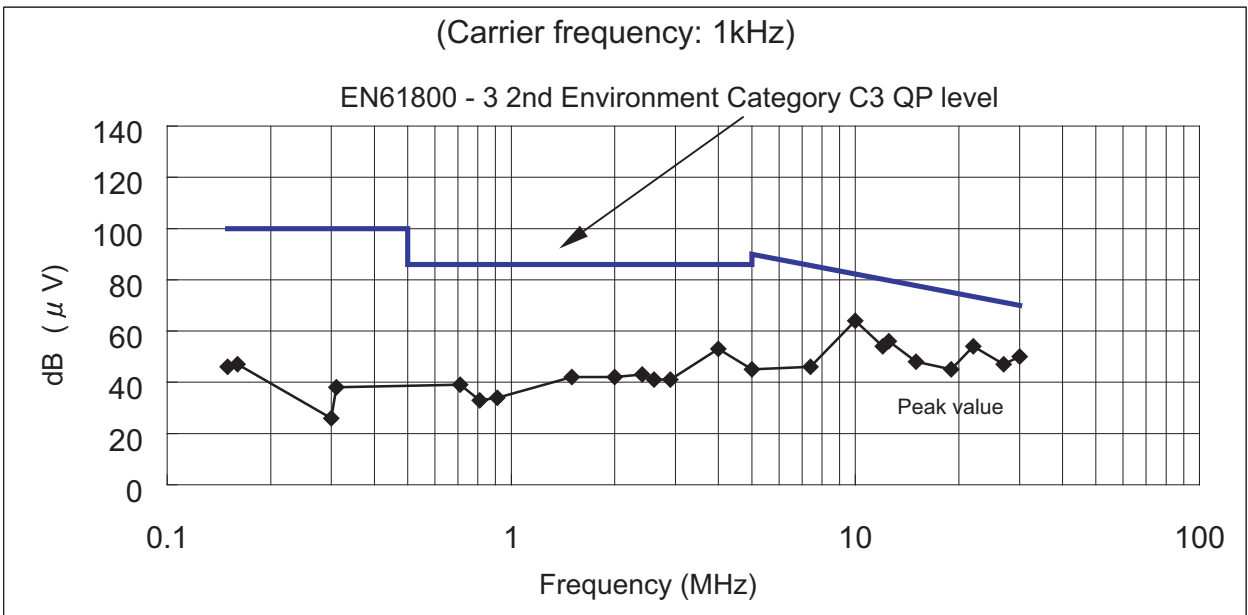

(Note) The QP value will not exceed the peak value.

© Radiated interference(10m site)

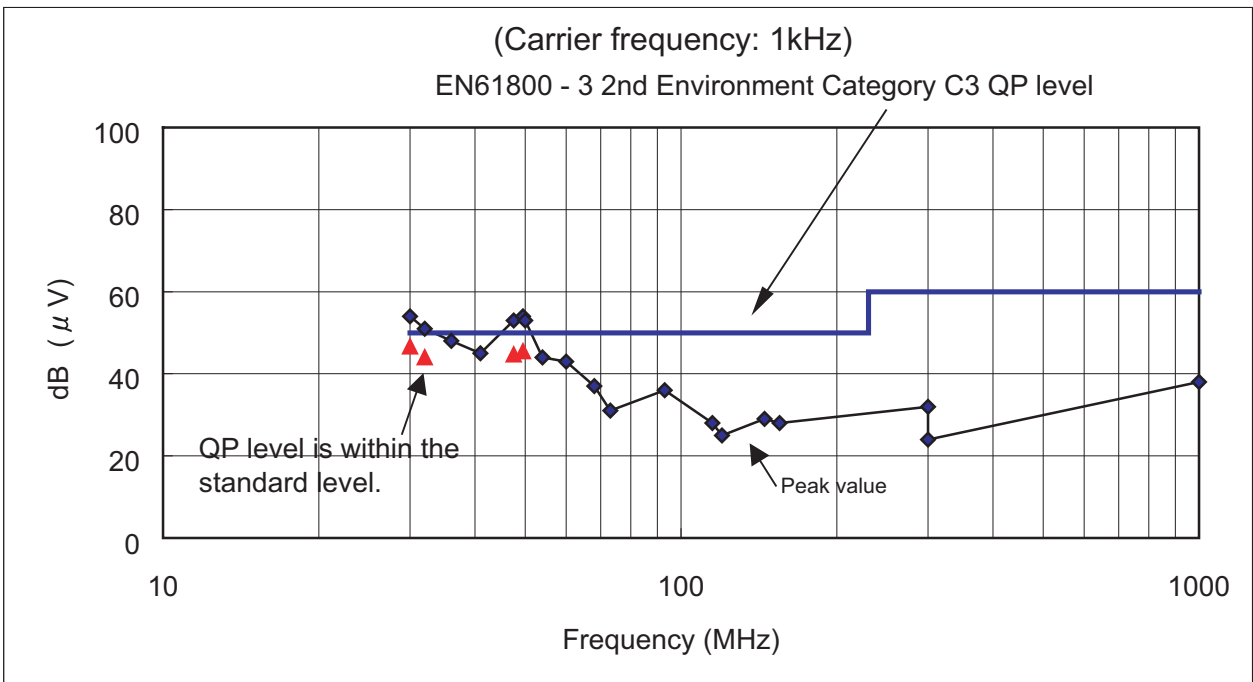

(Note) The QP value will not exceed the peak value.

• FR-E720-3.7K, SF1309

© Conducted interference

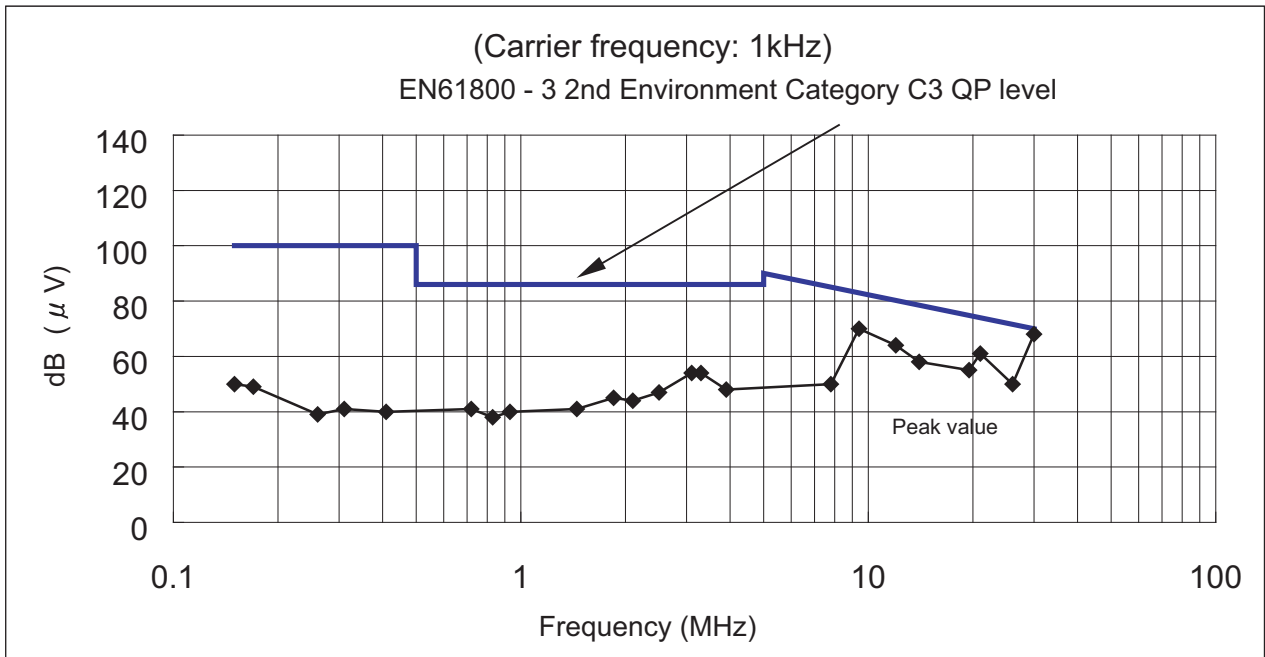

(Note) The QP value will not exceed the peak value.

© Radiated interference(10m site)

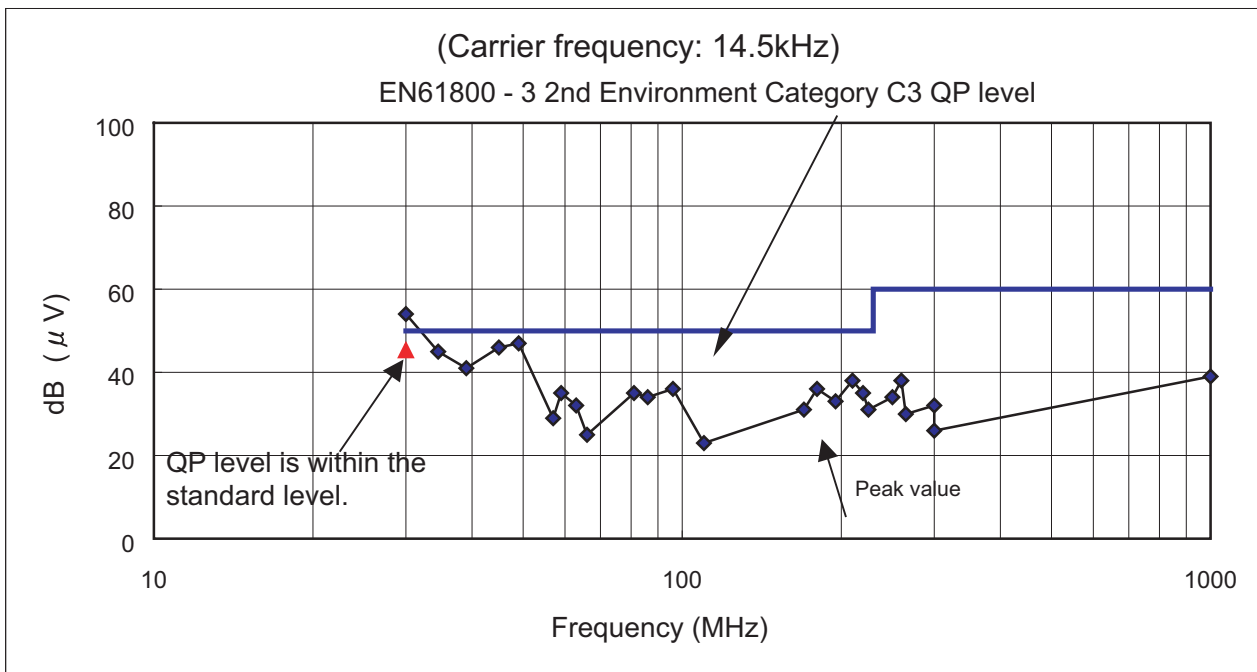

(Note) The QP value will not exceed the peak value.

• FR-E720-5.5K, SF1260

© Conducted interference

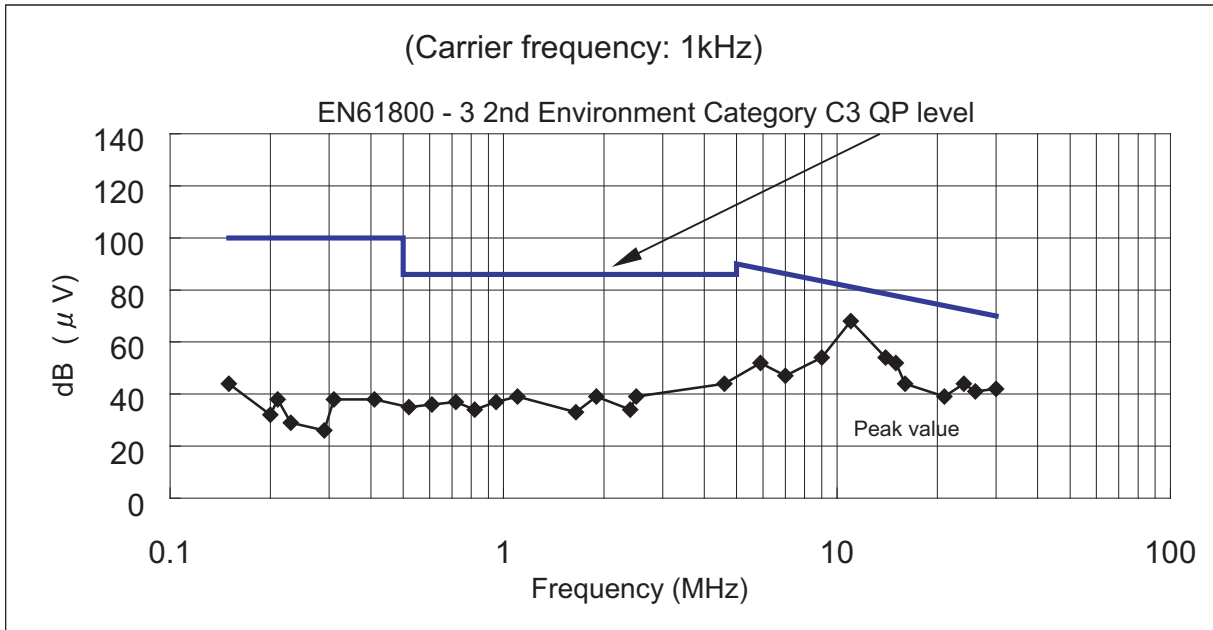

(Note) The QP value will not exceed the peak value.

© Radiated interference(10m site)

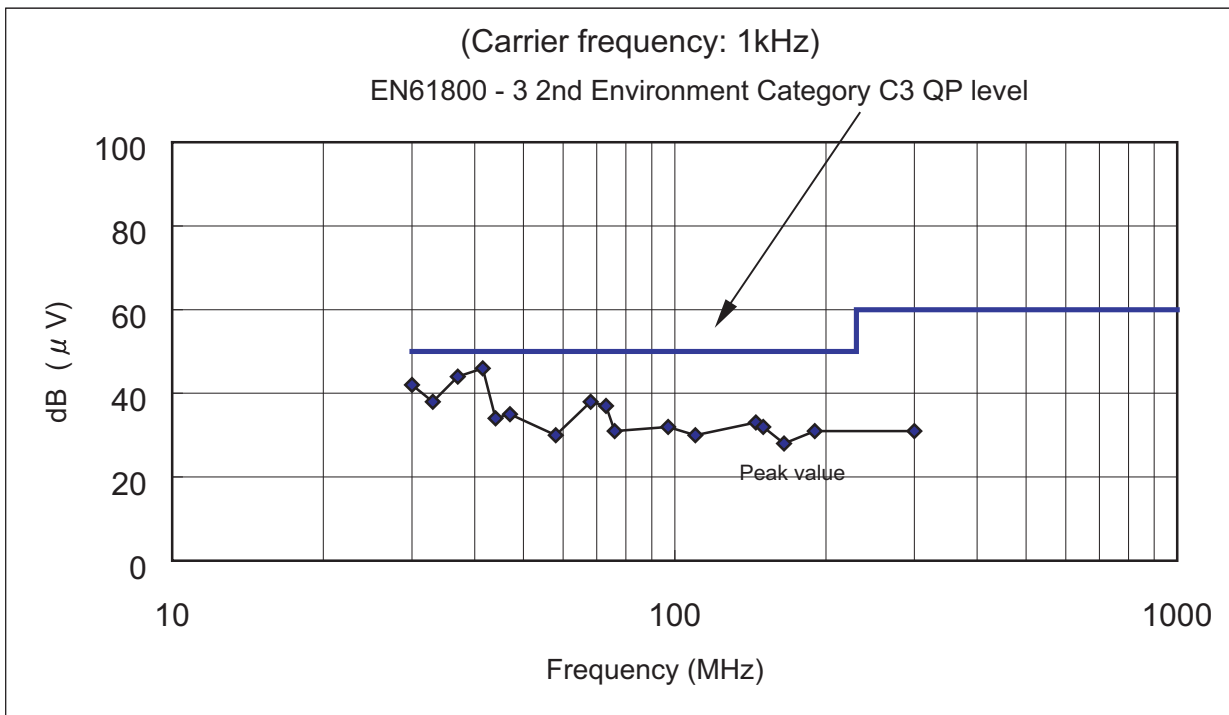

(Note) The QP value will not exceed the peak value.

• FR-E720-7.5K, SF1260

© Conducted interference

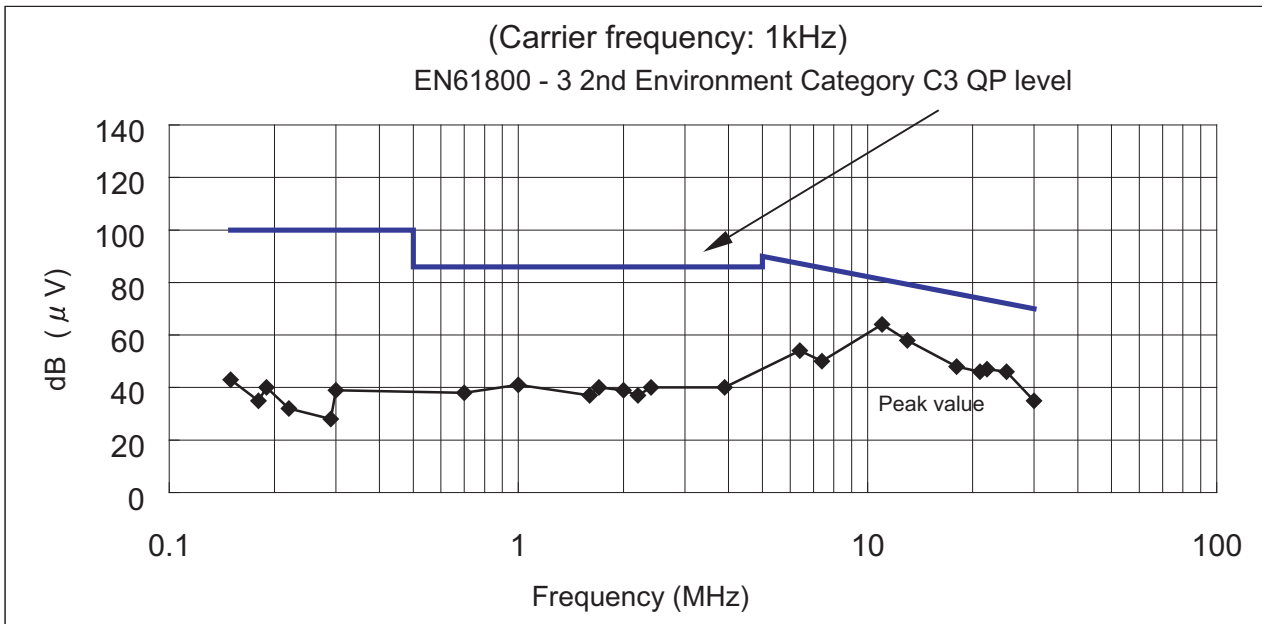

(Note) The QP value will not exceed the peak value.

© Radiated interference(10m site)

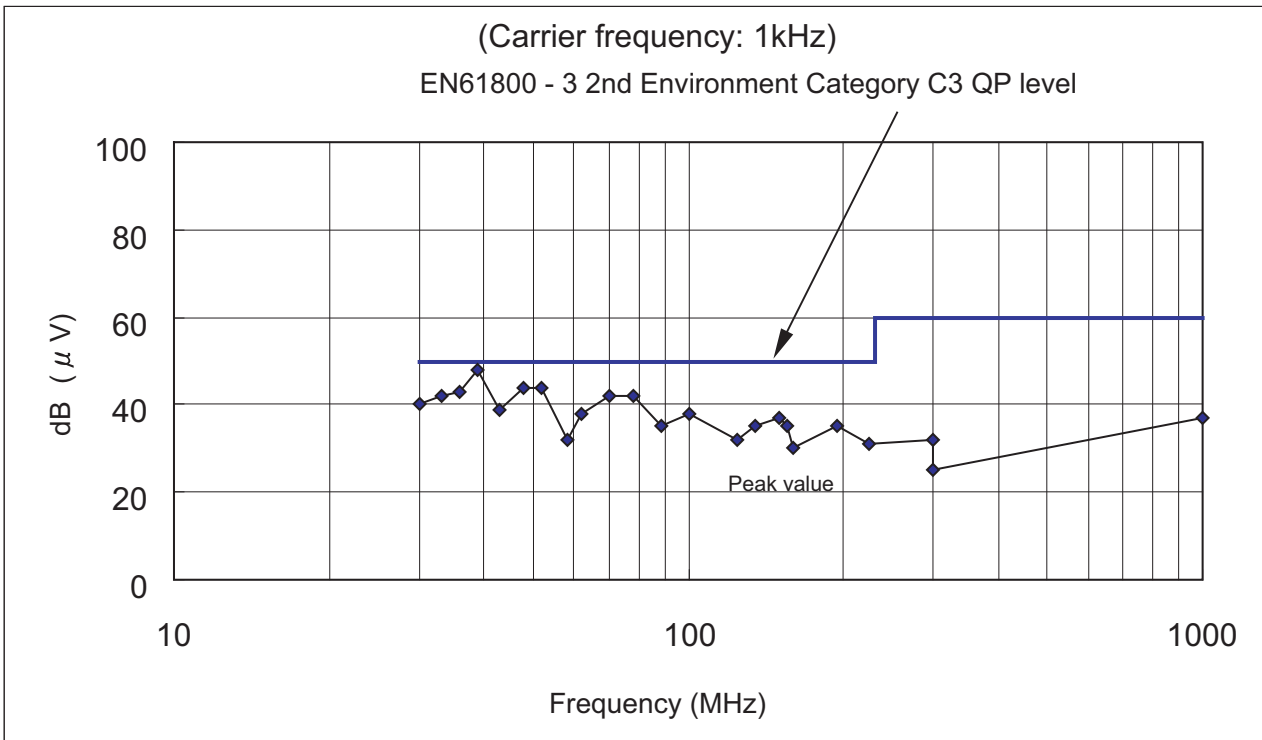

(Note) The QP value will not exceed the peak value.

• FR-E720-15K, SF1261

© Conducted interference

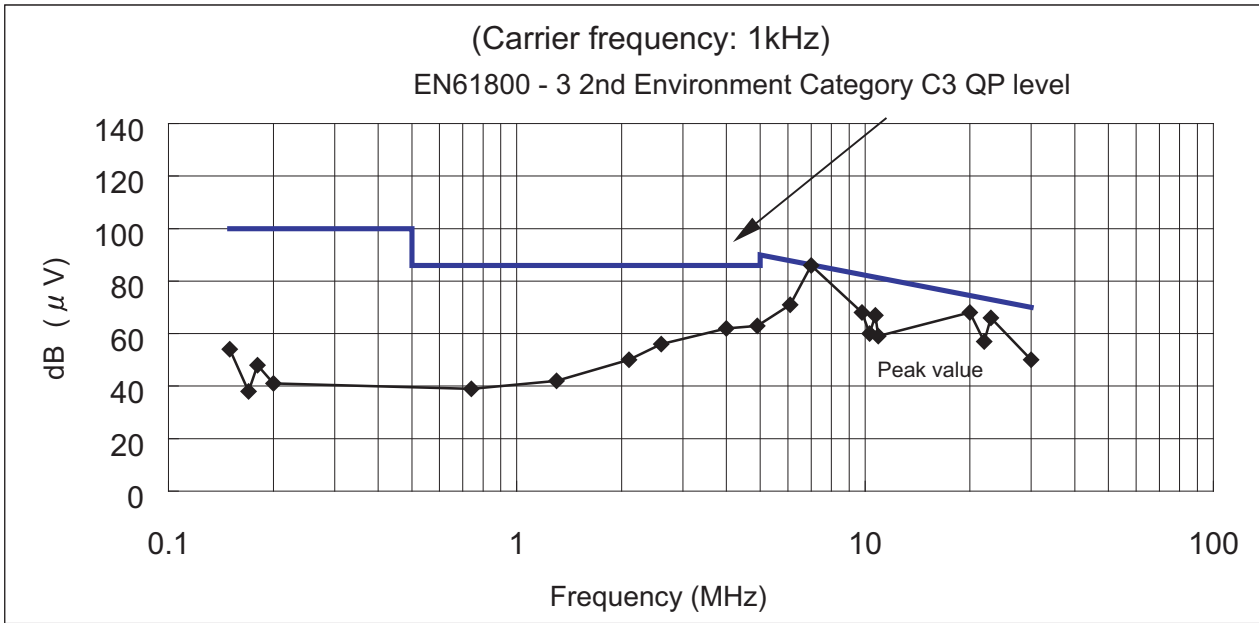

(Note) The QP value will not exceed the peak value.

© Radiated interference(10m site)

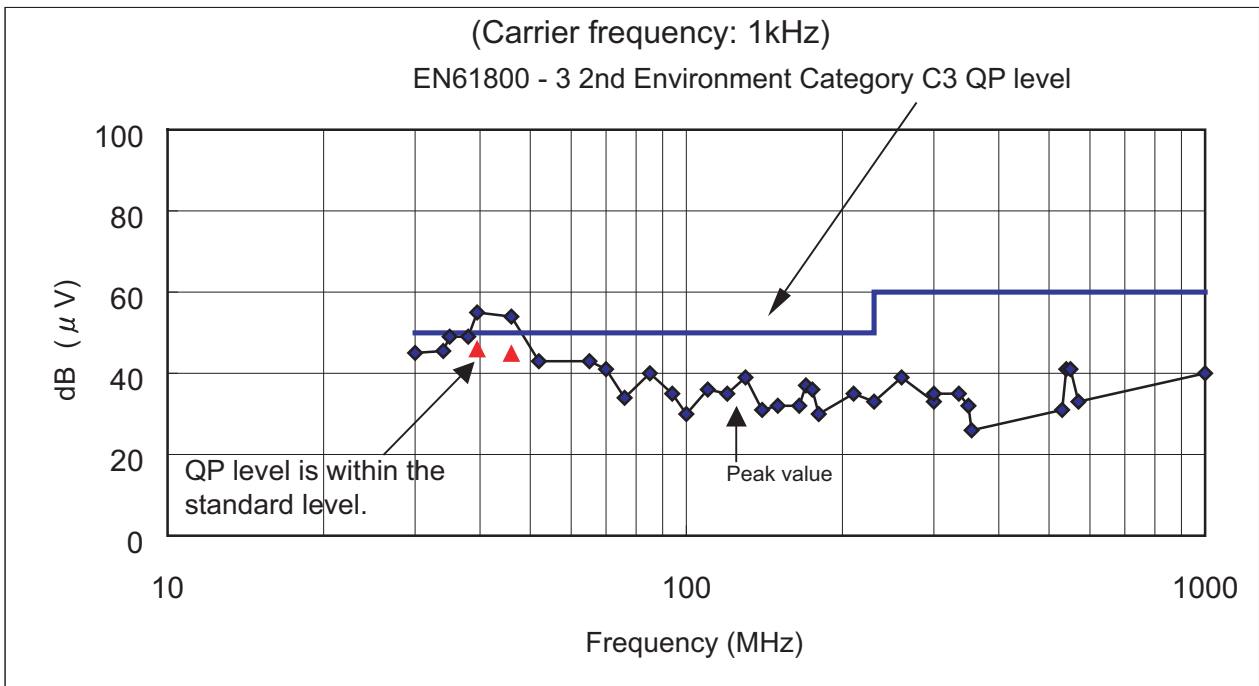

(Note) The QP value will not exceed the peak value.

# FR-E740

## <<Conditions>>

This inverter conforms with the product standard of EN61800-3.

Measurement was conducted according to the conditions of the product standard of EN61800-3 2nd environment.

Output wire length: 5m

Output cable: Shielded cable

Enclosure: No-door type

Operation frequency: 30Hz

Carrier frequency: Refer to the each graph

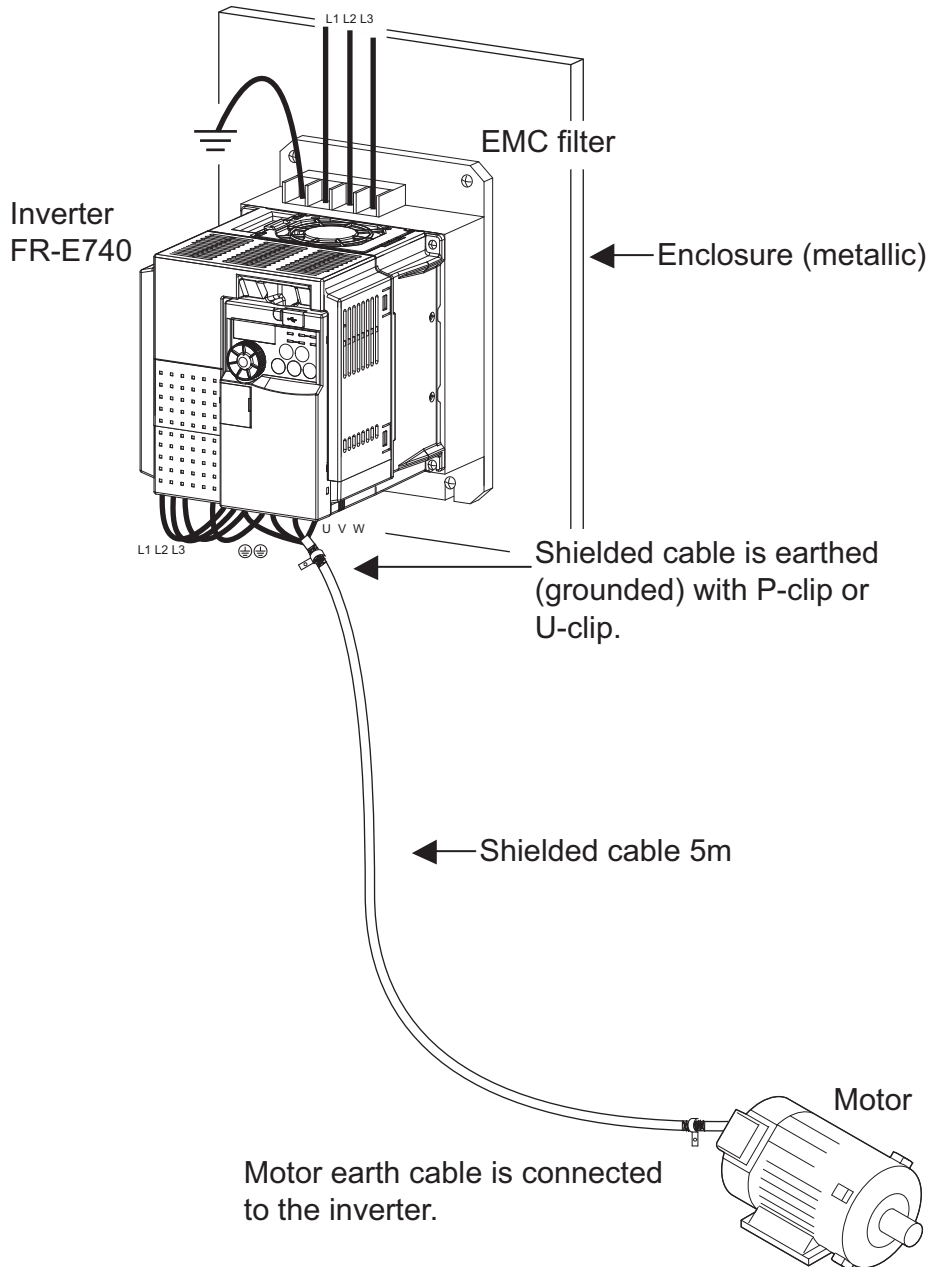

<<Measurement result>>

- FR-E740-0.75K, FR-E5NF-H0.75K

◎ Conducted interference

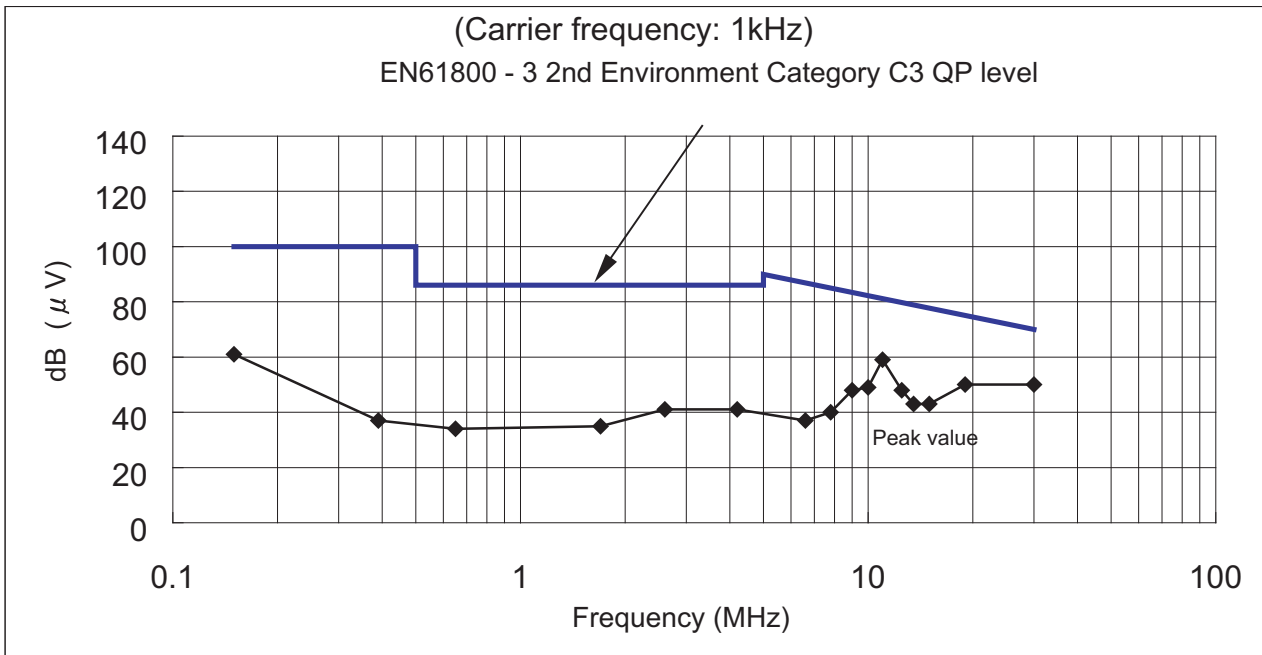

(Note) The QP value will not exceed the peak value.

◎ Radiated interference(10m site)

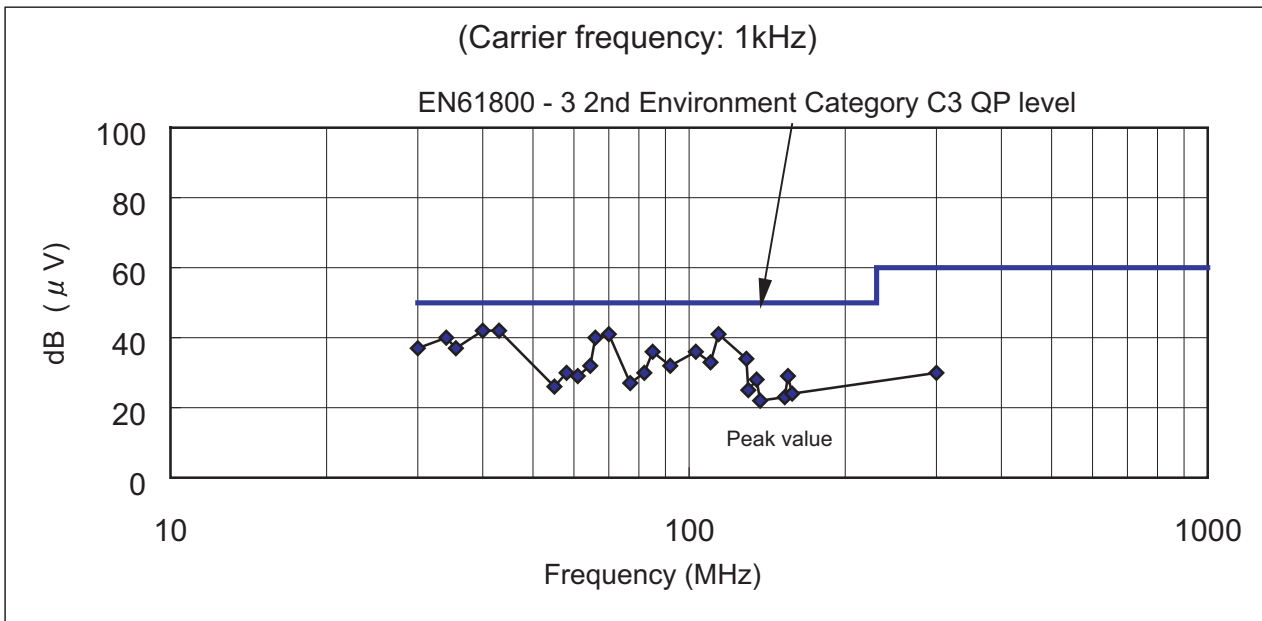

(Note) The QP value will not exceed the peak value.

- FR-E740-2.2K, FR-E5NF-H3.7K

⊙ Conducted interference

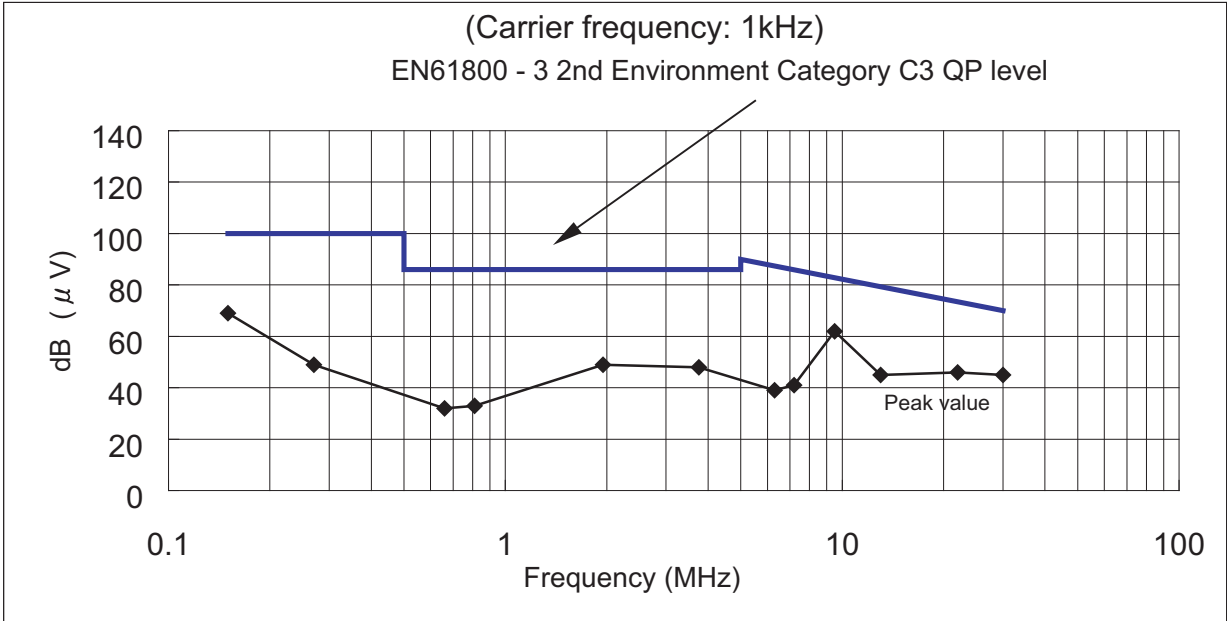

(Note) The QP value will not exceed the peak value.

⊙ Radiated interference(10m site)

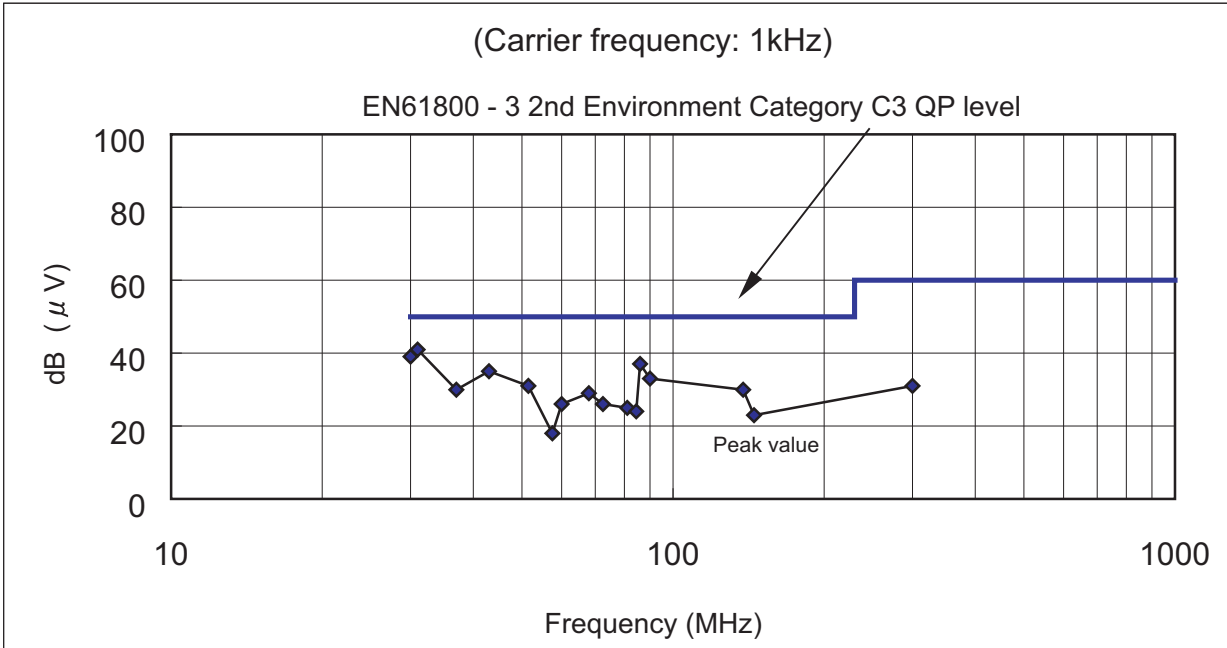

(Note) The QP value will not exceed the peak value.



• FR-E740-3.7K, FR-E5NF-H3.7K

© Conducted interference

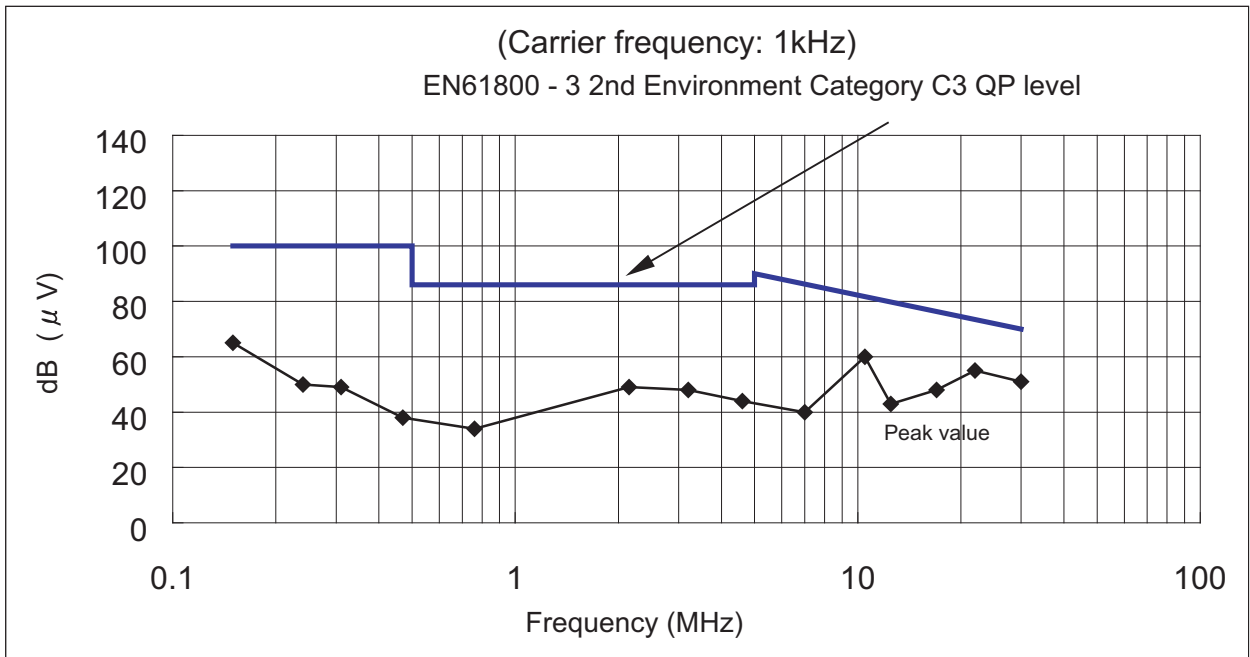

(Note) The QP value will not exceed the peak value.

© Radiated interference(10m site)

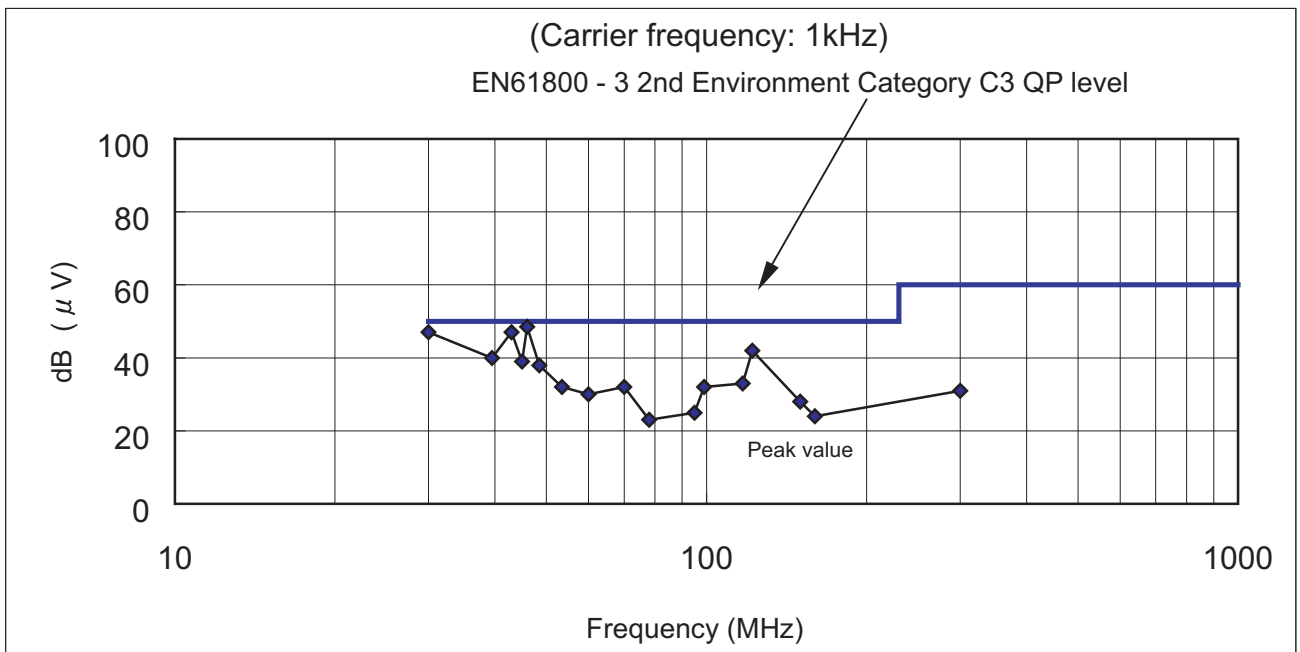

(Note) The QP value will not exceed the peak value.

• FR-E740-5.5K, FR-E5NF-H7.5K

◎ Conducted interference

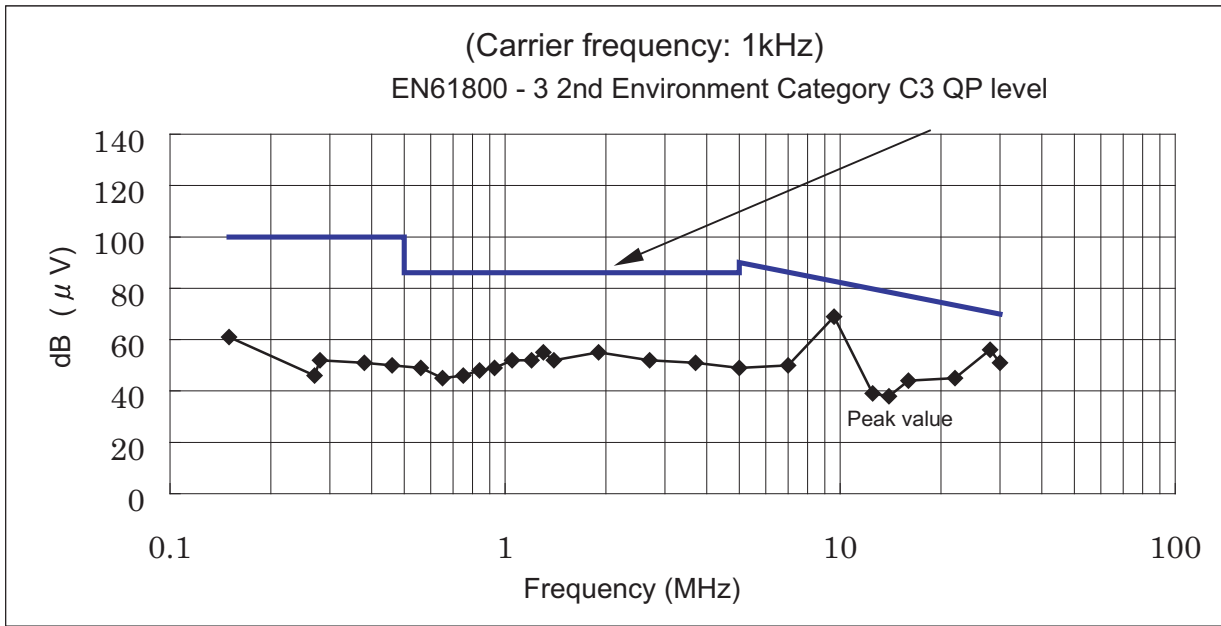

(Note) The QP value will not exceed the peak value.

◎ Radiated interference(10m site)

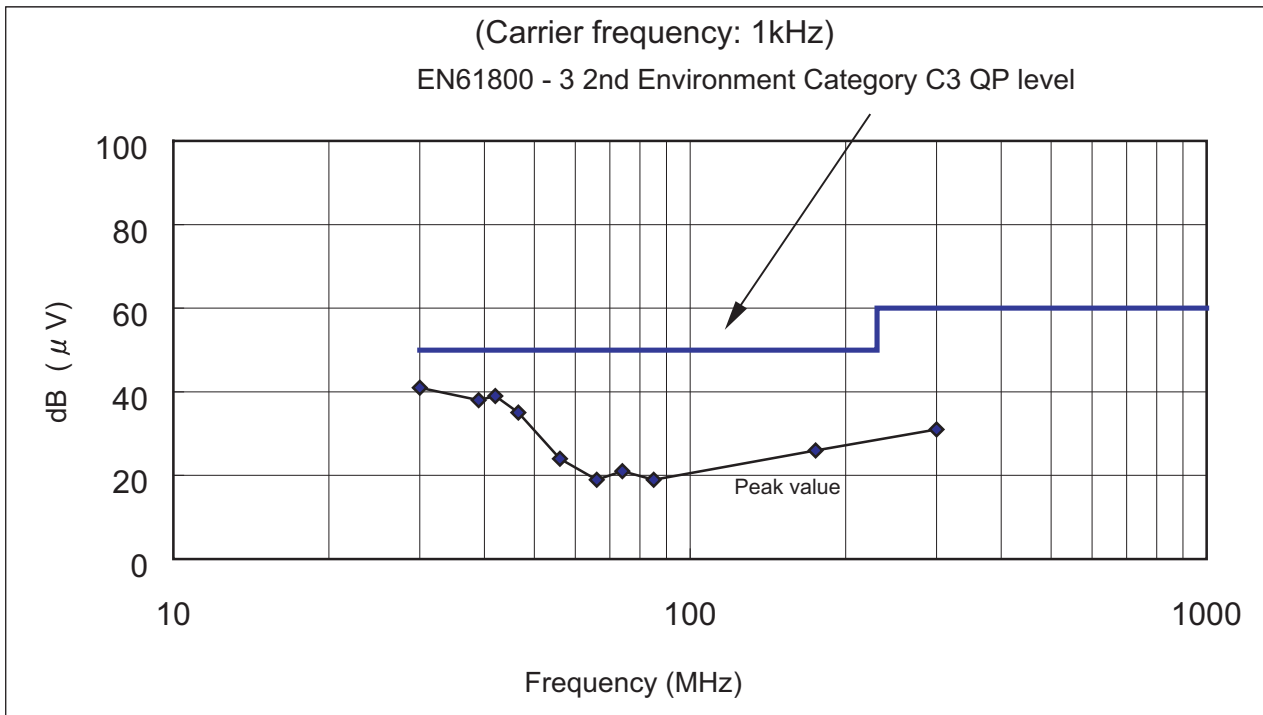

(Note) The QP value will not exceed the peak value.

• FR-E740-7.5K, FR-E5NF-H7.5K

◎ Conducted interference

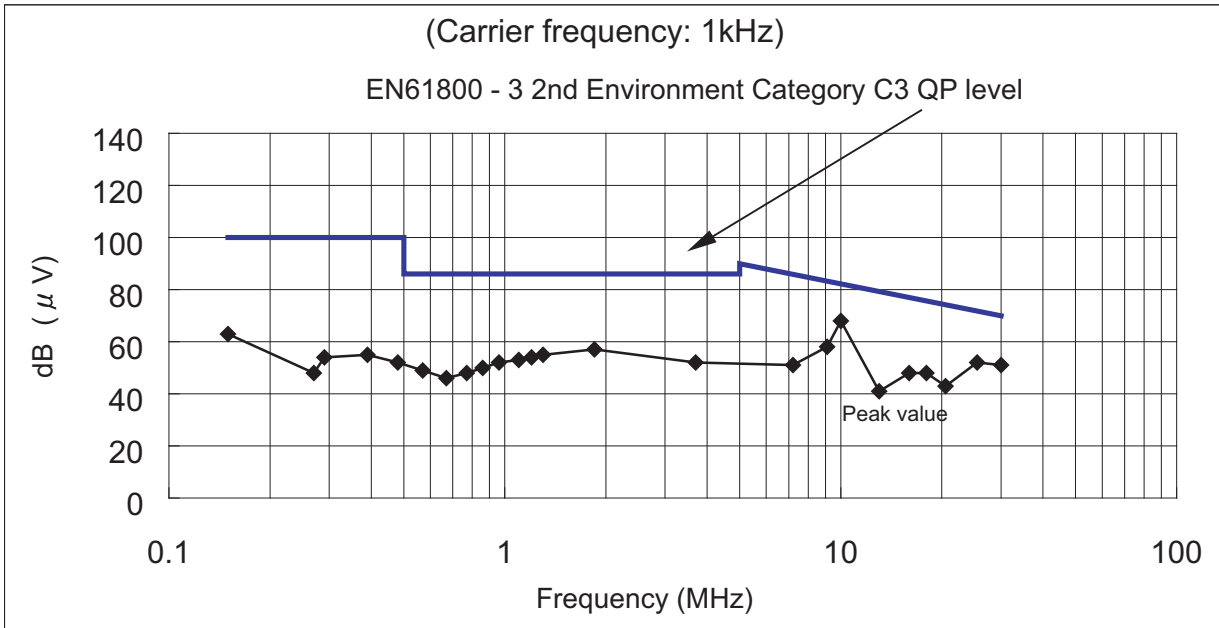

(Note) The QP value will not exceed the peak value.

◎ Radiated interference(10m site)

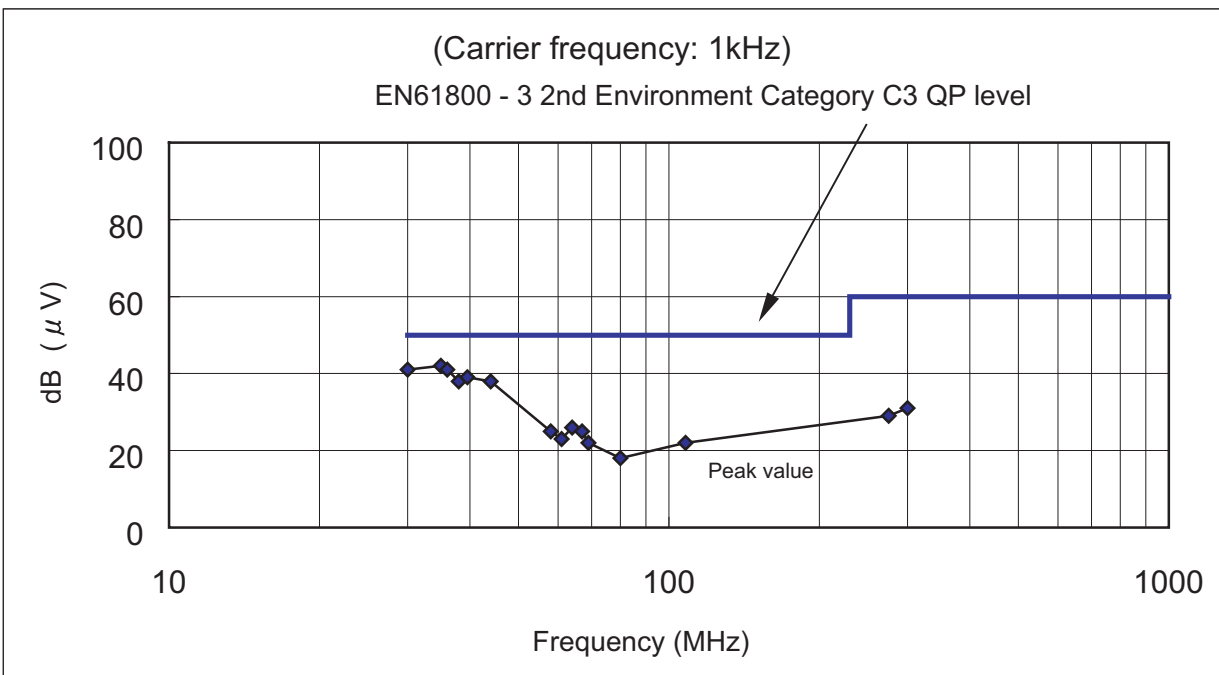

(Note) The QP value will not exceed the peak value.

# FR-E720S

## <<Conditions>>

This inverter conforms with the product standard of EN61800-3.

Measurement was conducted according to the conditions of the product standard of EN61800-3 2nd environment.

Output wire length: 5m

Output cable: Shielded cable

Enclosure: No-door type

Operation frequency: 30Hz

Carrier frequency: Refer to the each graph

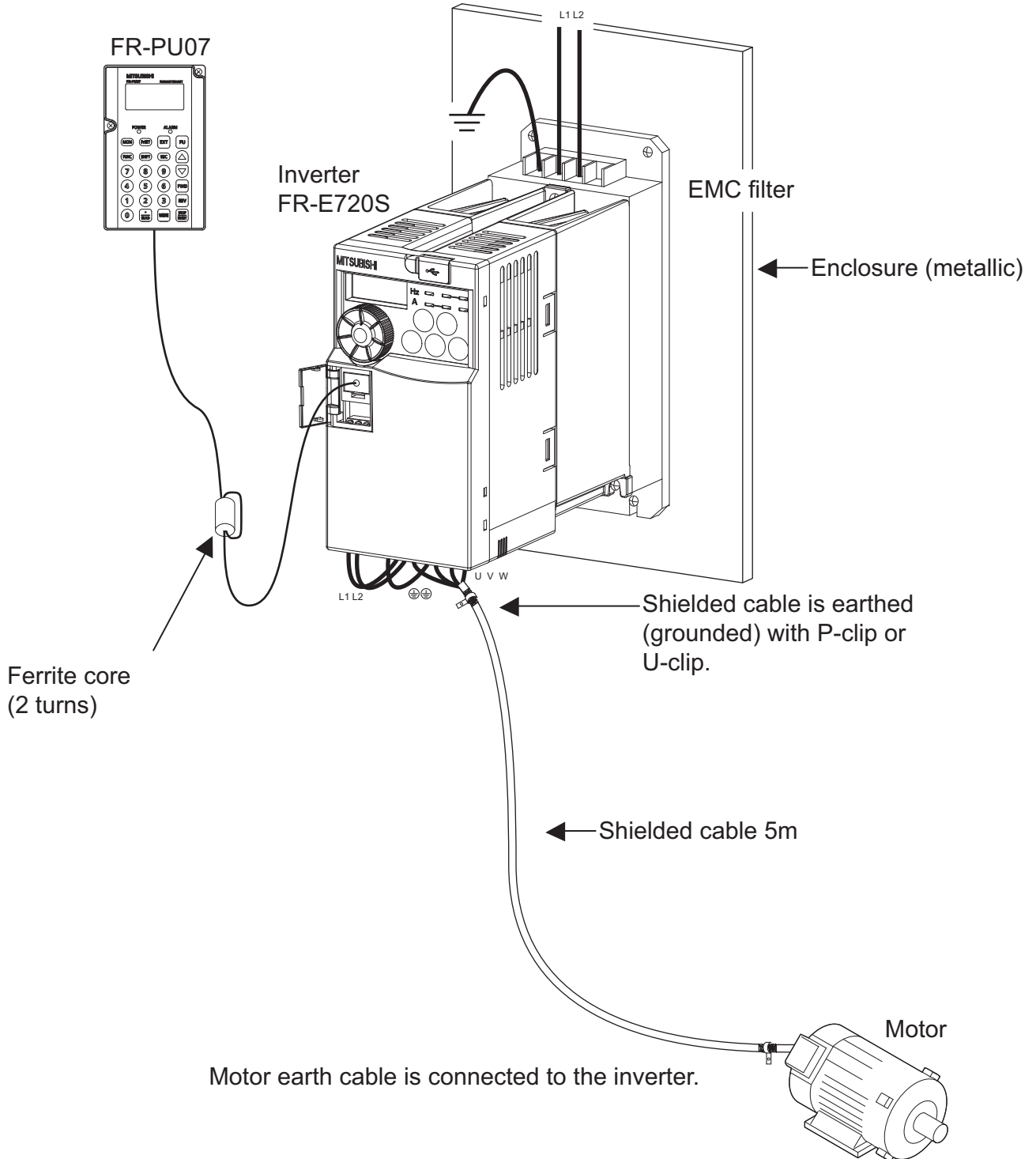

• FR-E720S-0.4K, SF1320

◎ Conducted interference

(Note) Ferrite core is wrapped two turns around the parameter unit connection cable.

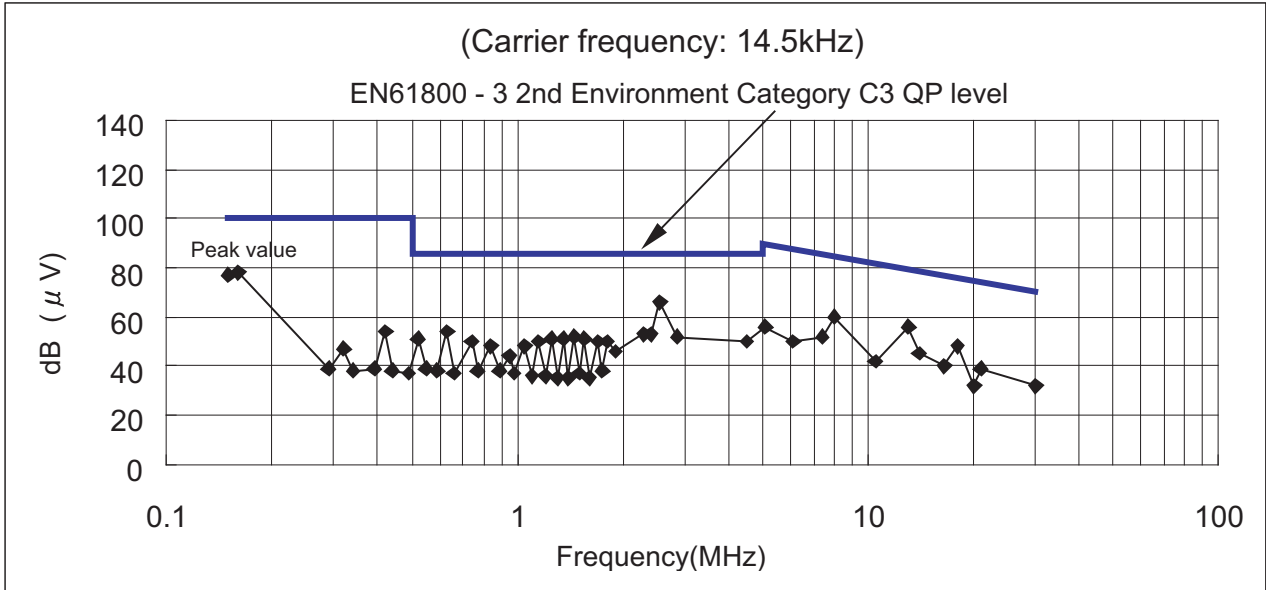

(Note) The QP value will not exceed the peak value.

◎ Radiated interference(10m site)

(Note) Ferrite core is wrapped two turns around the parameter unit connection cable.

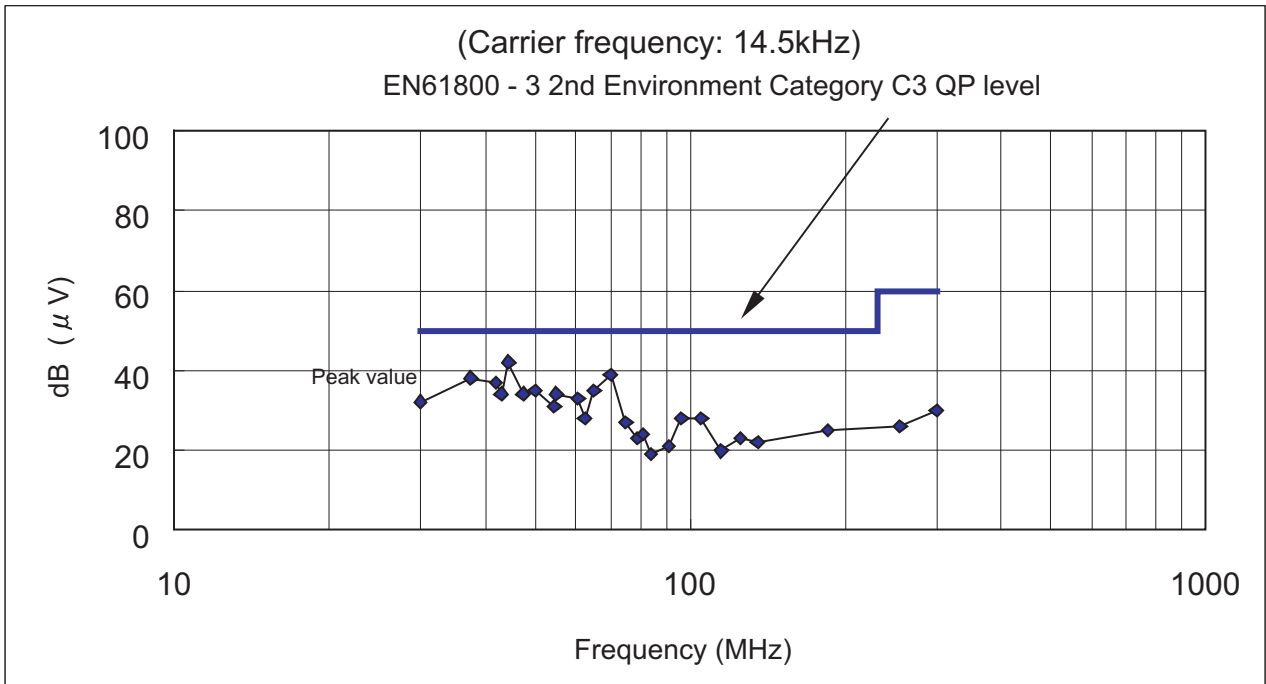

(Note) The QP value will not exceed the peak value.

• FR-E720S-1.5K, FR-S5NFSA-1.5K

◎ Conducted interference

(Note) Ferrite core is wrapped two turns around the parameter unit connection cable and one turn at the input side.

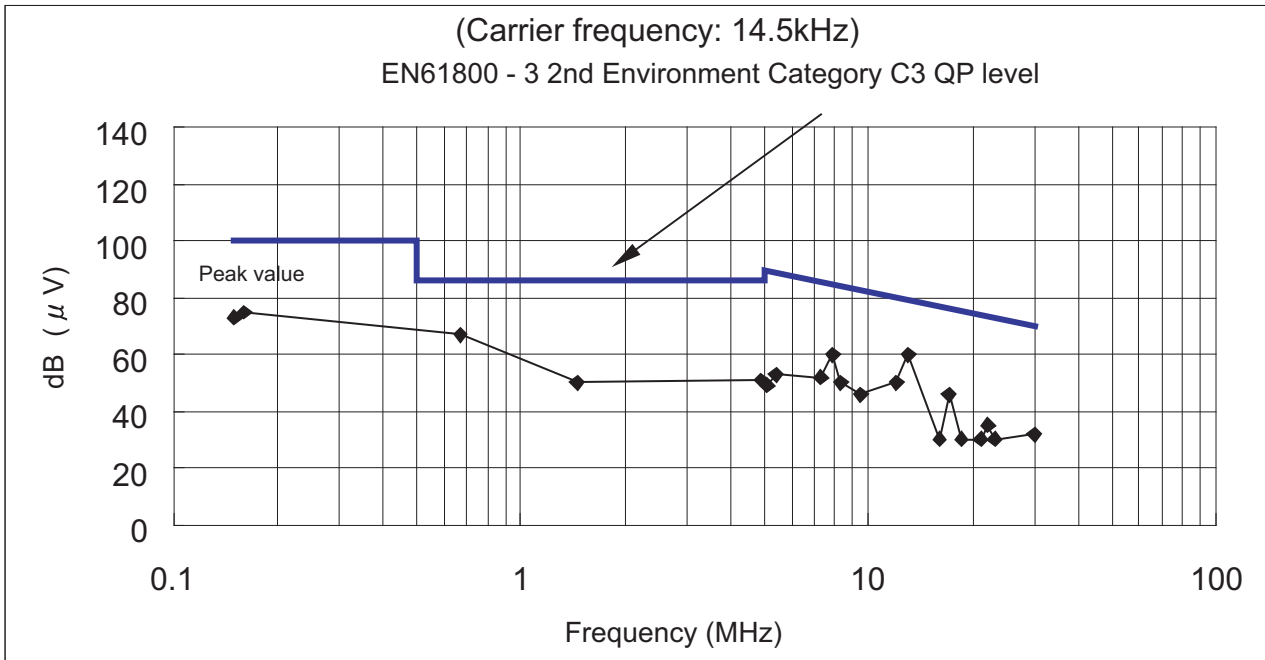

(Note) The QP value will not exceed the peak value.

◎ Radiated interference(10m site)

(Note) Ferrite core is wrapped two turns around the parameter unit connection cable and one turn at the input side.

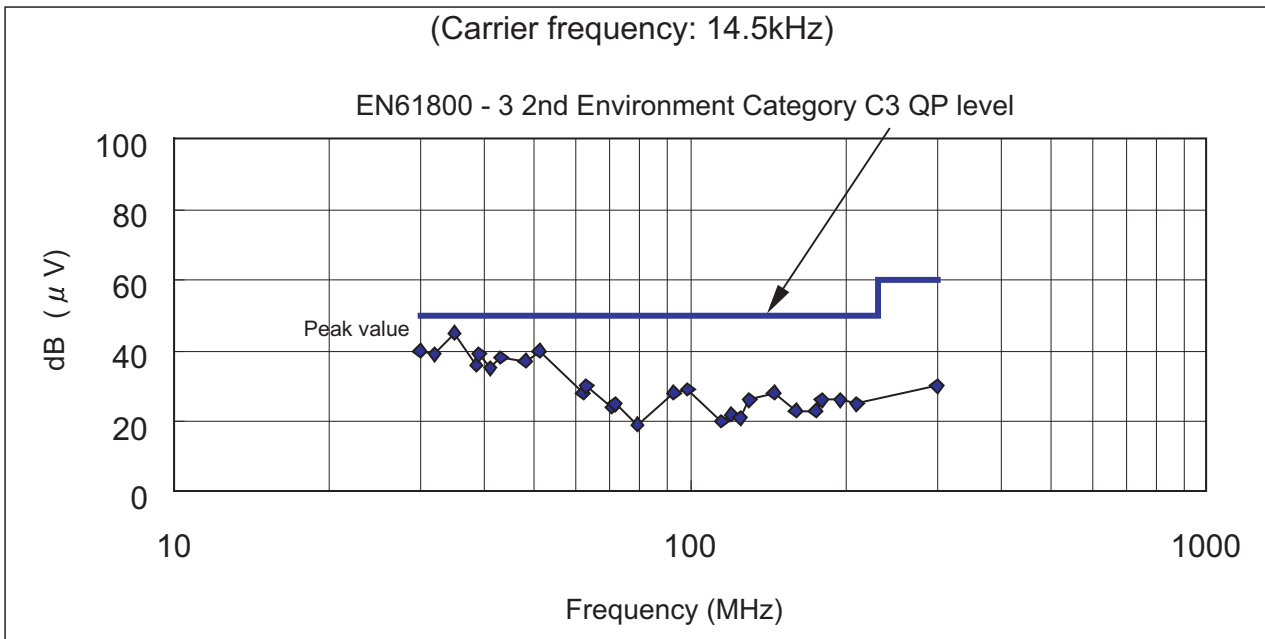

(Note) The QP value will not exceed the peak value.

• FR-E720S-2.2K, SF1309

◎ Conducted interference

(Note) Ferrite core is wrapped two turns around the parameter unit connection cable.

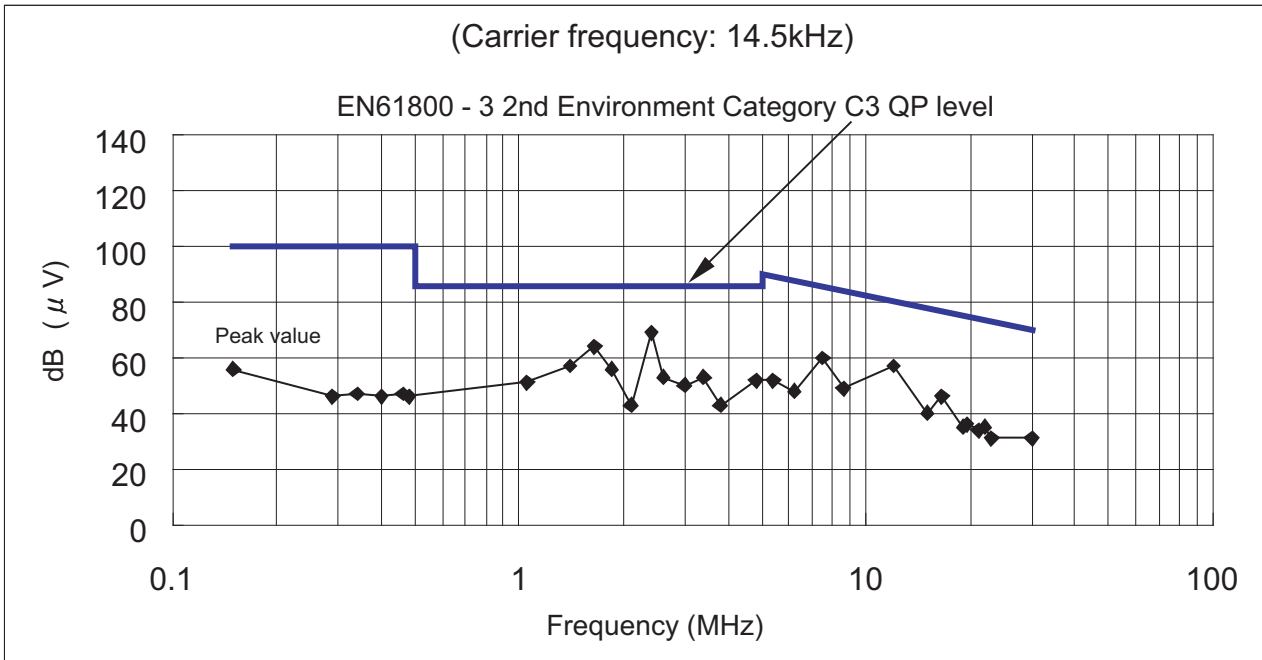

(Note) The QP value will not exceed the peak value.

◎ Radiated interference(10m site)

(Note) Ferrite core is wrapped two turns around the parameter unit connection cable.

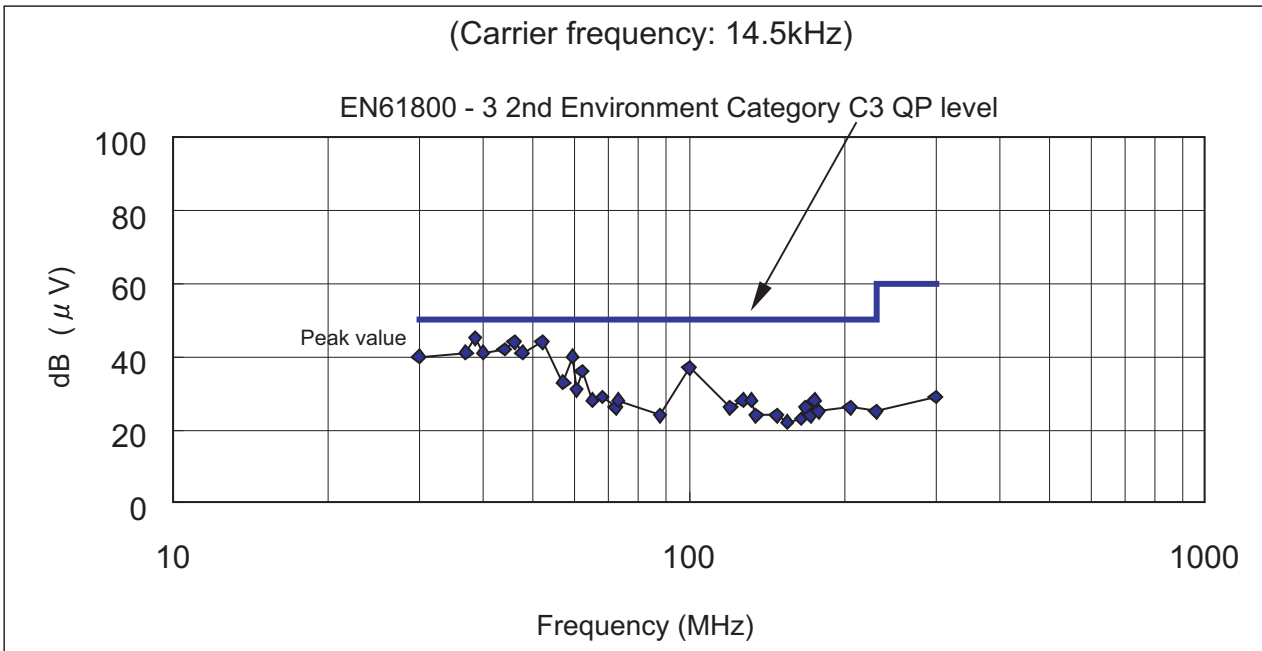

(Note) The QP value will not exceed the peak value.

FR-D720

<<Conditions>>

This inverter conforms with the product standard of EN61800-3.  
 Measurement was conducted according to the conditions of the product standard of EN61800-3 2nd environment.

Output wire length: 20m

Operation frequency: 30Hz

Output cable: Shielded cable

Carrier frequency: Refer to the each graph

Enclosure: No-door type

For radiated interference, ferrite core is wrapped 2 turns around the parameter unit connection cable.

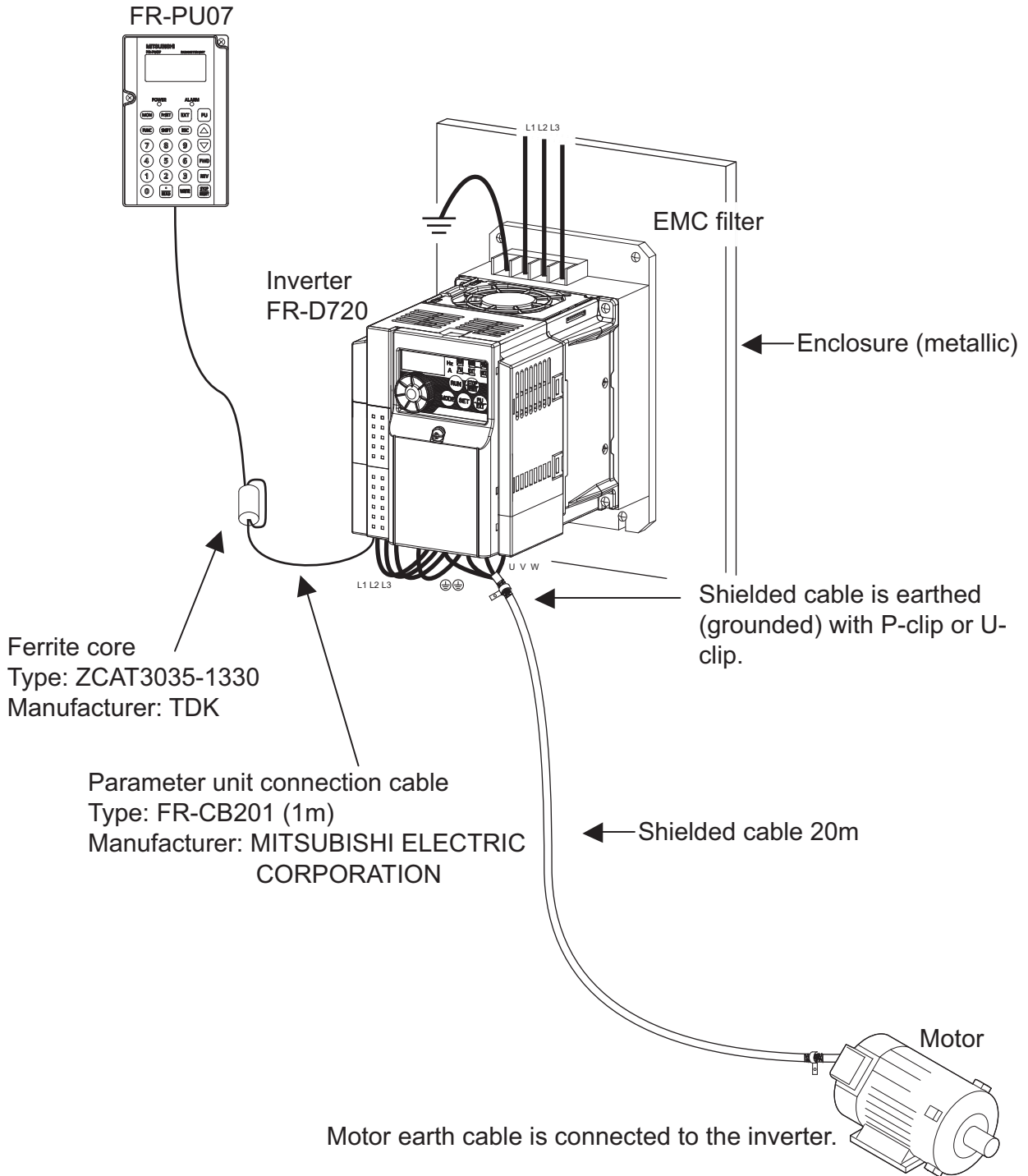



• FR-D720-0.75K, SF1306

© Conducted interference

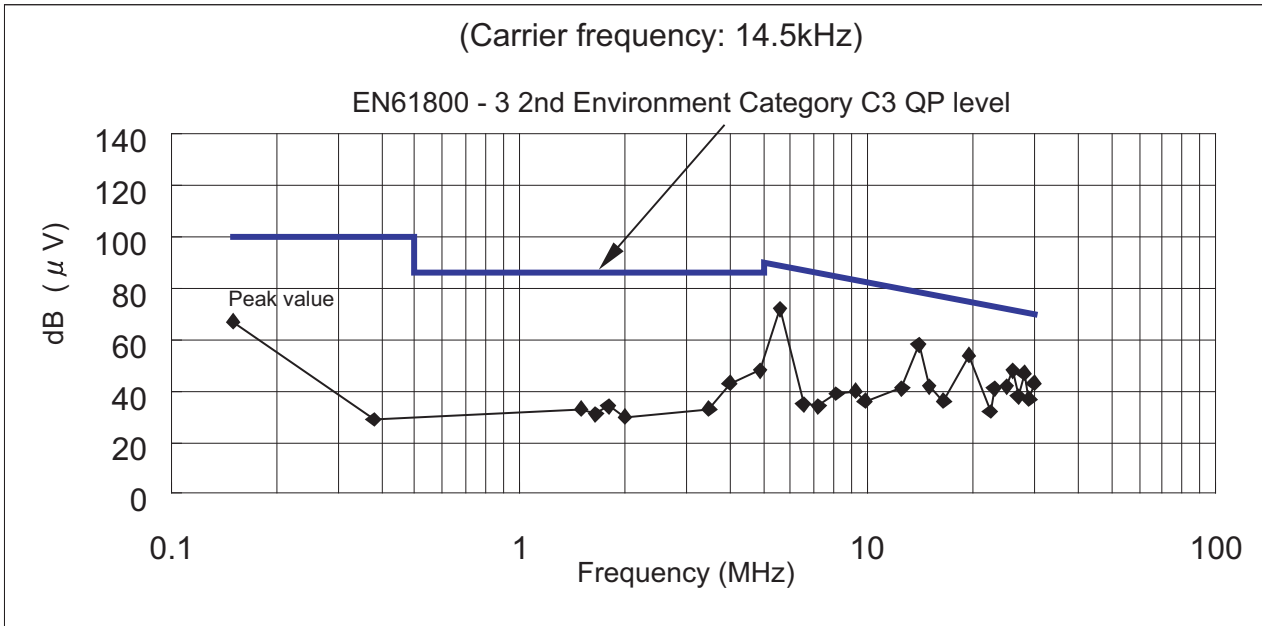

(Note) The QP value will not exceed the peak value.

© Radiated interference(10m site)

(Note) FR-BIF and FR-BSF01(2-turn) are installed in the input side.

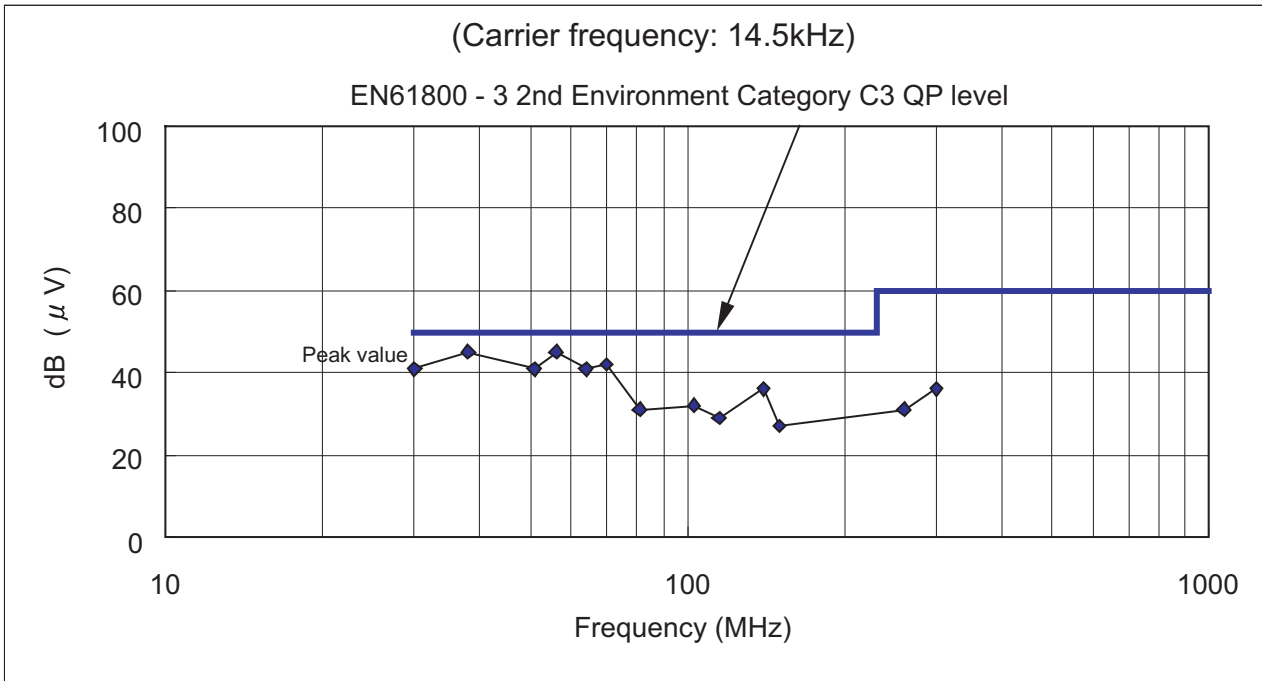

(Note) The QP value will not exceed the peak value.

• FR-D720-2.2K, SF1309

◎ Conducted interference

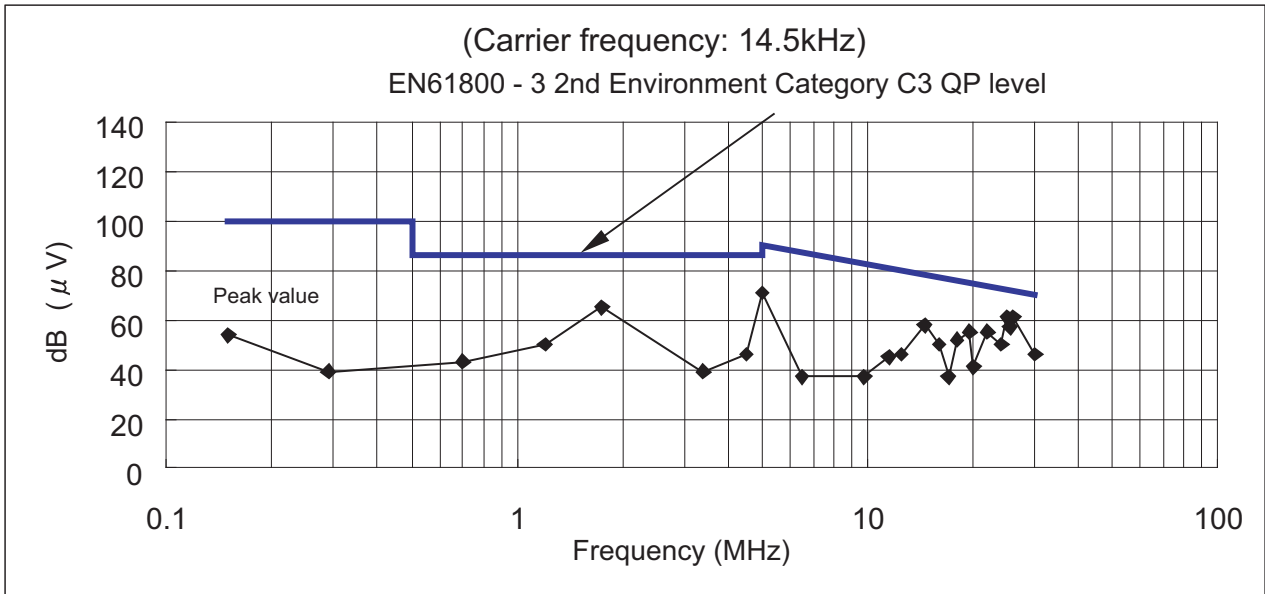

(Note) The QP value will not exceed the peak value.

◎ Radiated interference(10m site)

(Note) FR-BIF and FR-BSF01(2-turn) are installed in the input side.

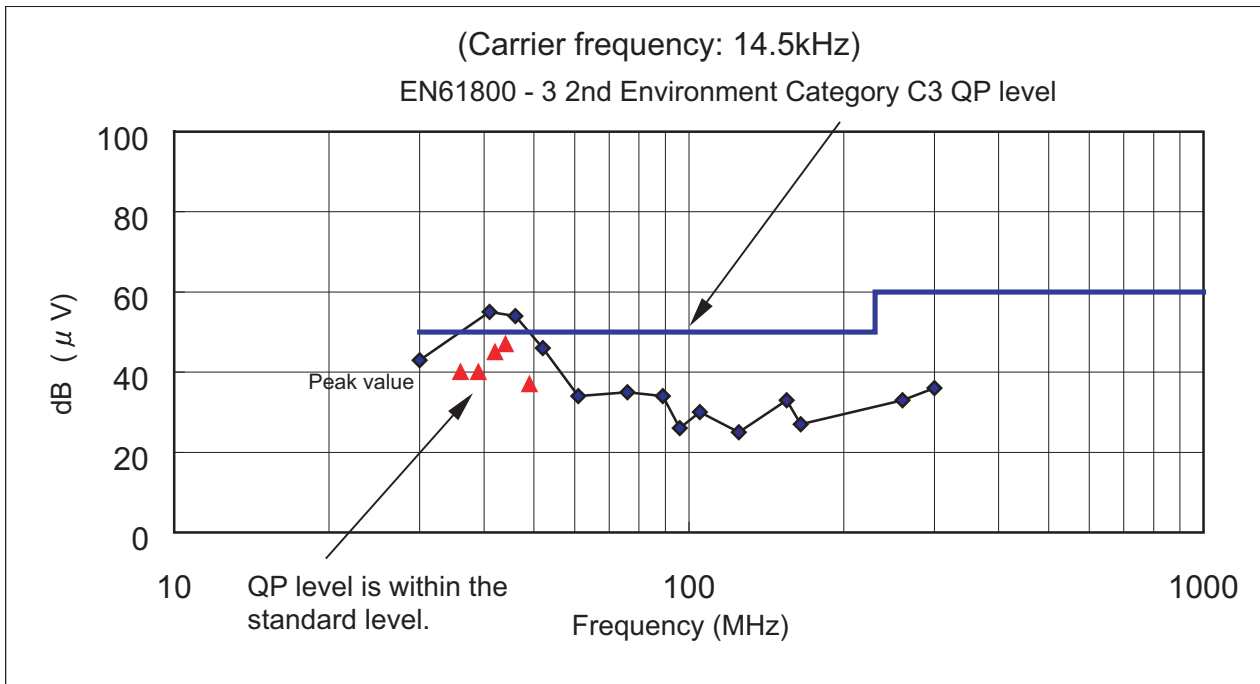

(Note) The QP value will not exceed the peak value.

© Conducted interference

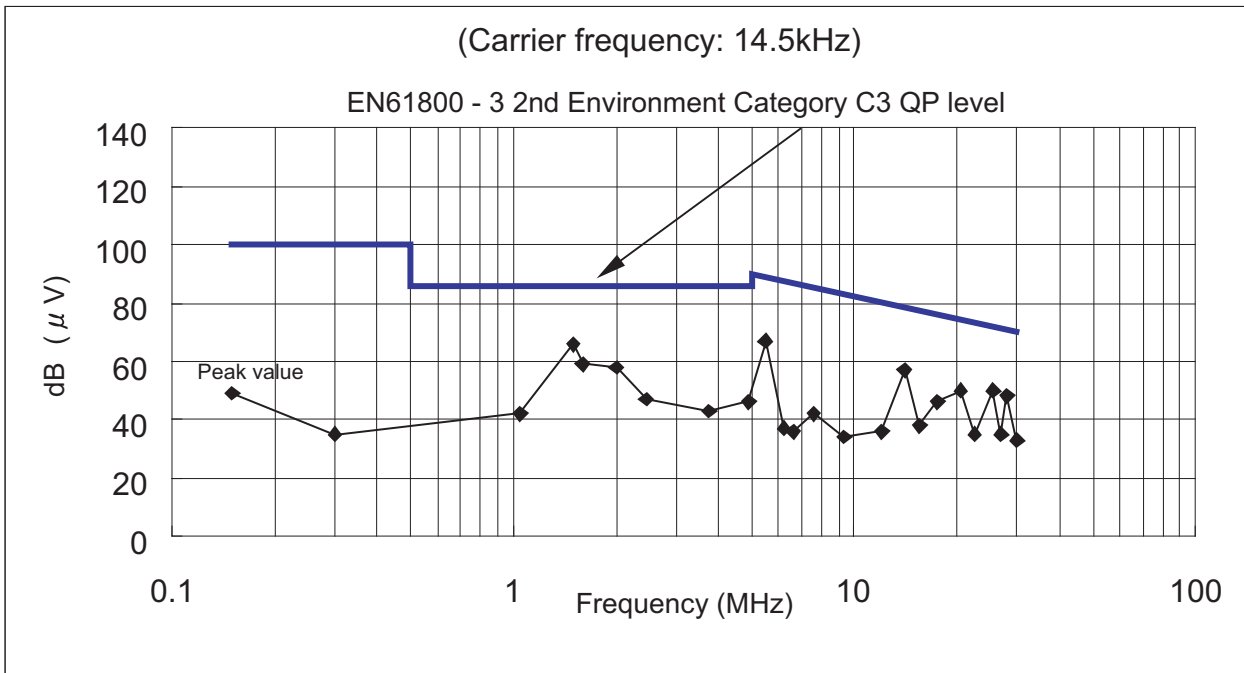

(Note) The QP value will not exceed the peak value.

© Radiated interference(10m site)

(Note) FR-BIF and FR-BSF01(2-turn) are installed in the input side.

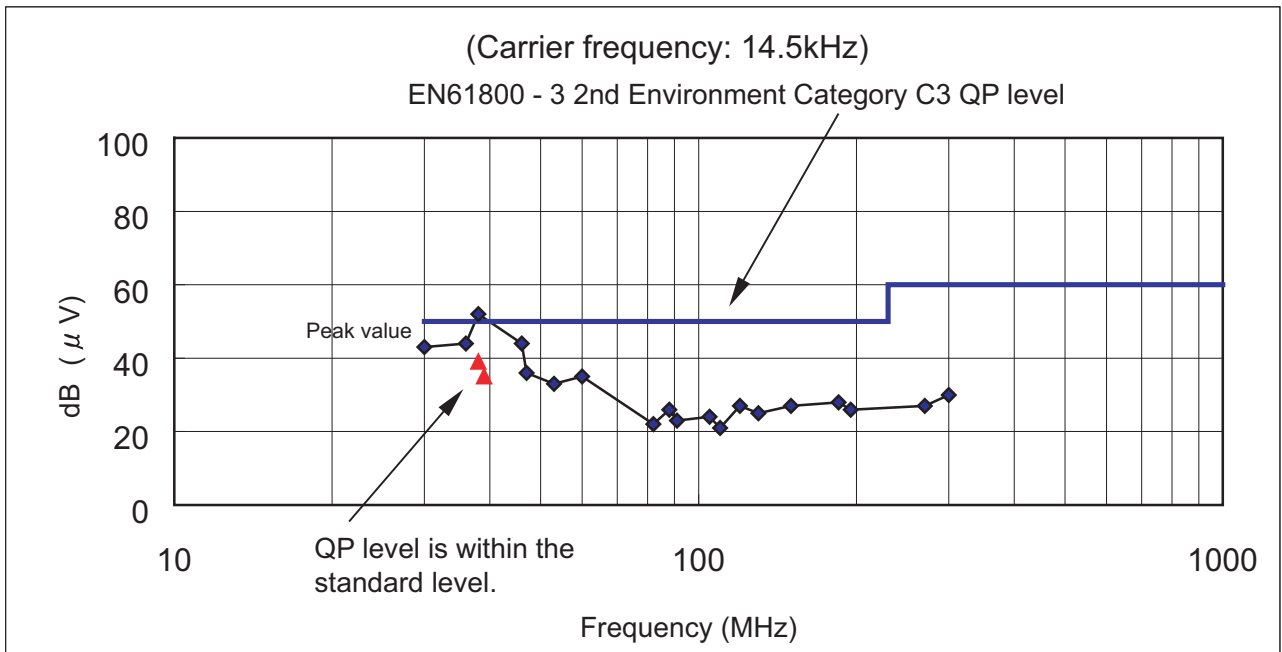

(Note) The QP value will not exceed the peak value.

• FR-D720-7.5K, SF1260

◎ Conducted interference

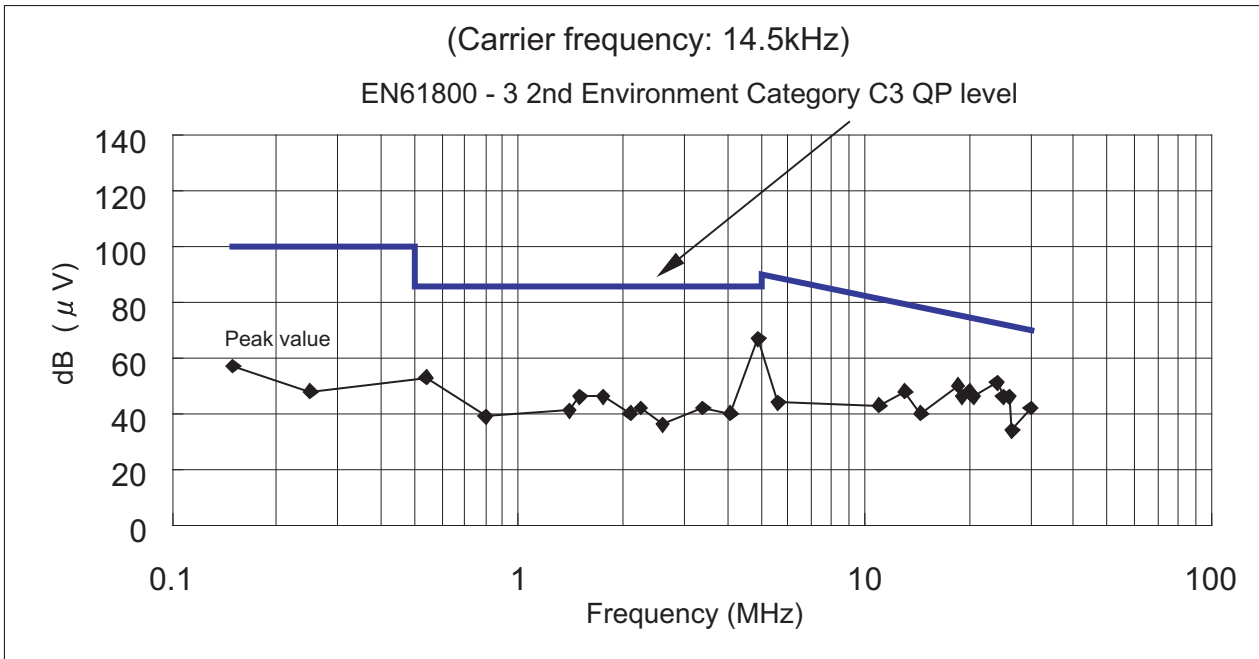

(Note) The QP value will not exceed the peak value.

◎ Radiated interference(10m site)

(Note) FR-BIF and FR-BSF01(2-turn) are installed in the input side.

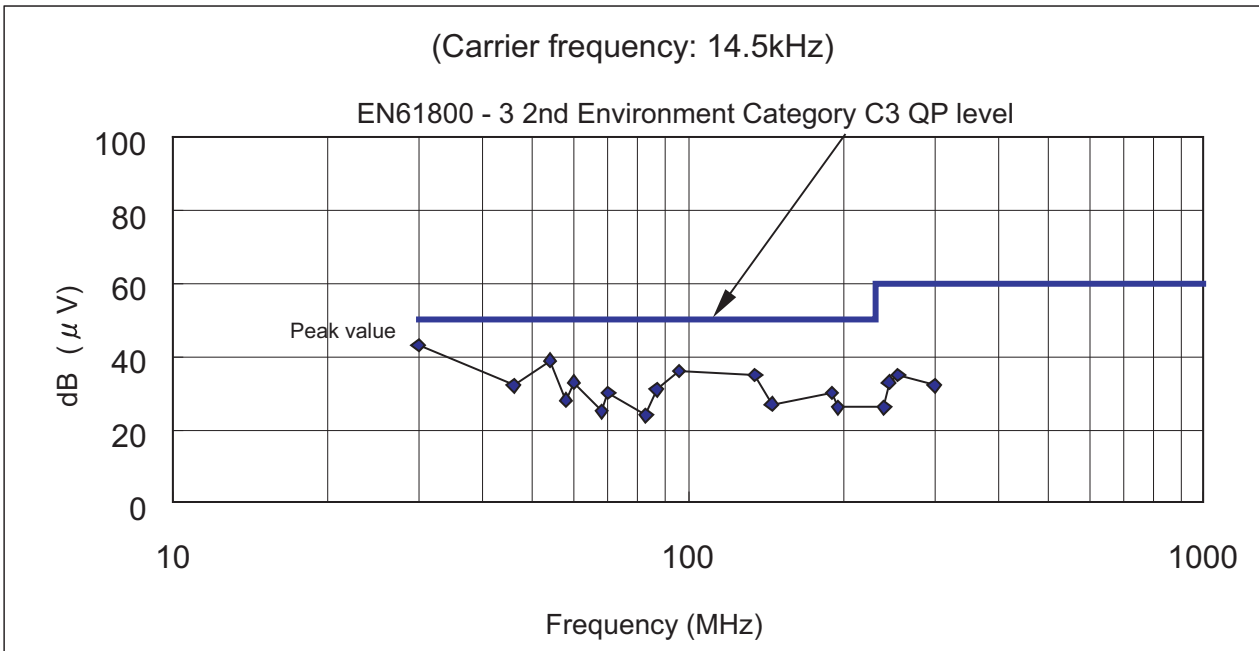

(Note) The QP value will not exceed the peak value.

# FR-D740

## <<Conditions>>

This inverter conforms with the product standard of EN61800-3.

Measurement was conducted according to the conditions of the product standard of EN61800-3 2nd environment.

Output wire length: 20m

Output cable: Shielded cable

Enclosure: No-door type

Operation frequency: 30Hz

Carrier frequency: Refer to the each graph

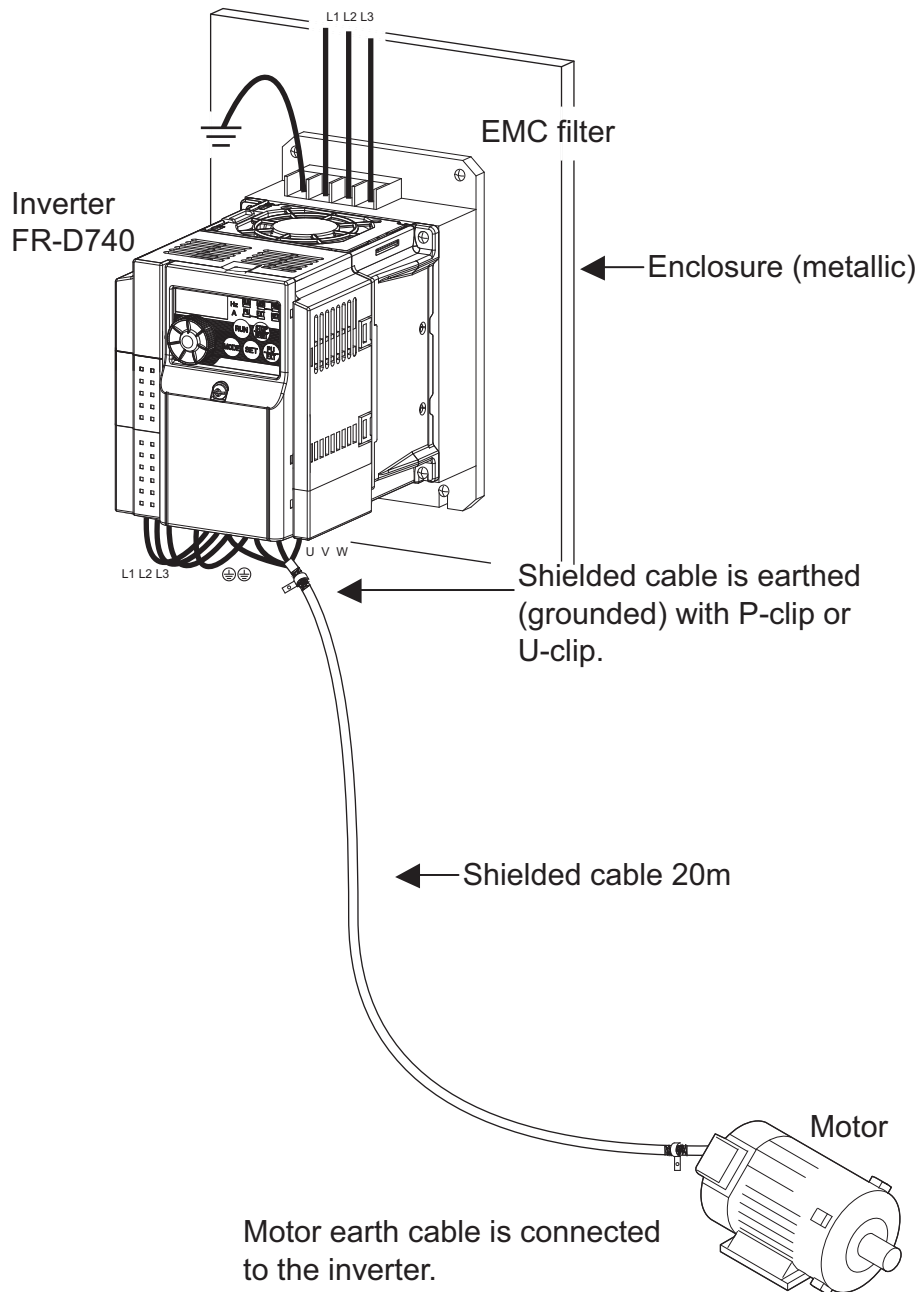

<<Measurement result>>

- FR-D740-0.75K, FR-E5NF-H0.75K

⊙ Conducted interference

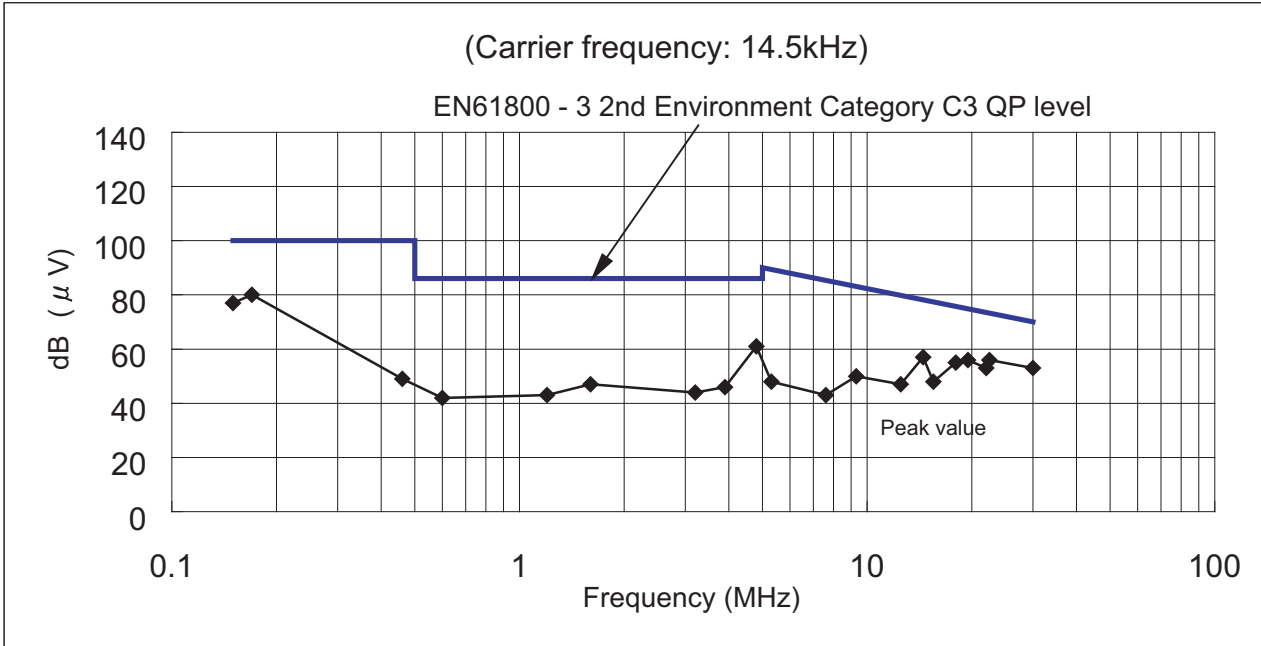

(Note) The QP value will not exceed the peak value.

⊙ Radiated interference(10m site)

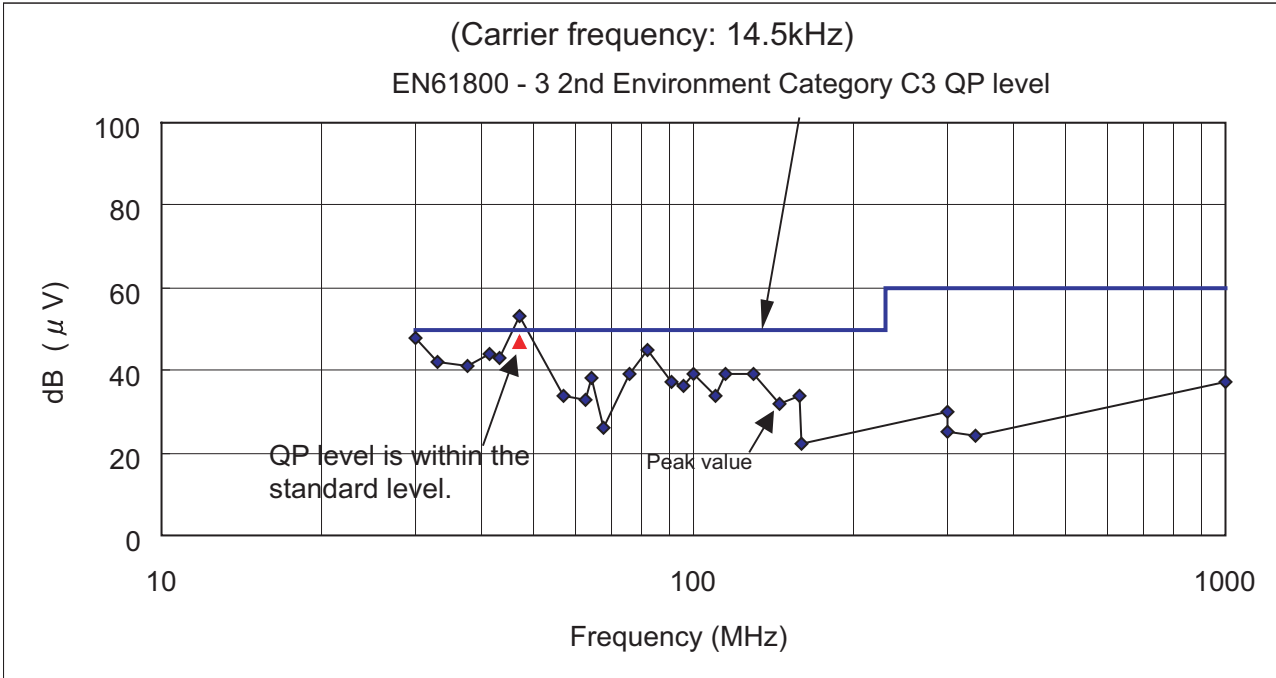

(Note) The QP value will not exceed the peak value.

• FR-D740-2.2K, FR-E5NF-H3.7K

◎ Conducted interference

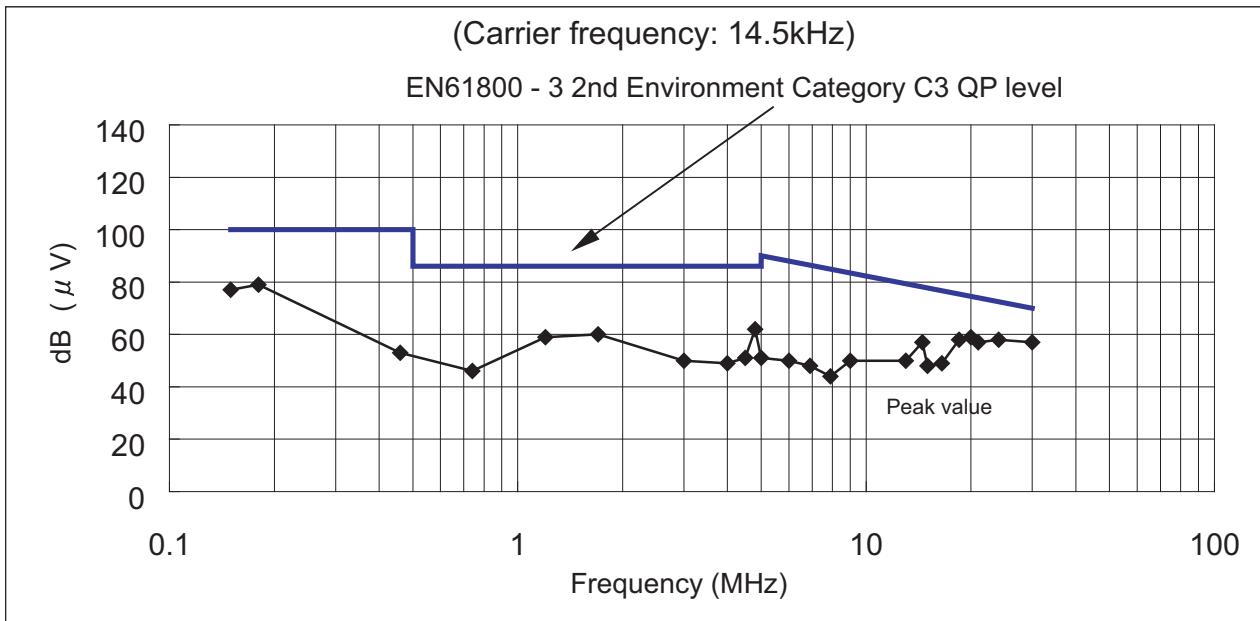

(Note) The QP value will not exceed the peak value.

◎ Radiated interference(10m site)

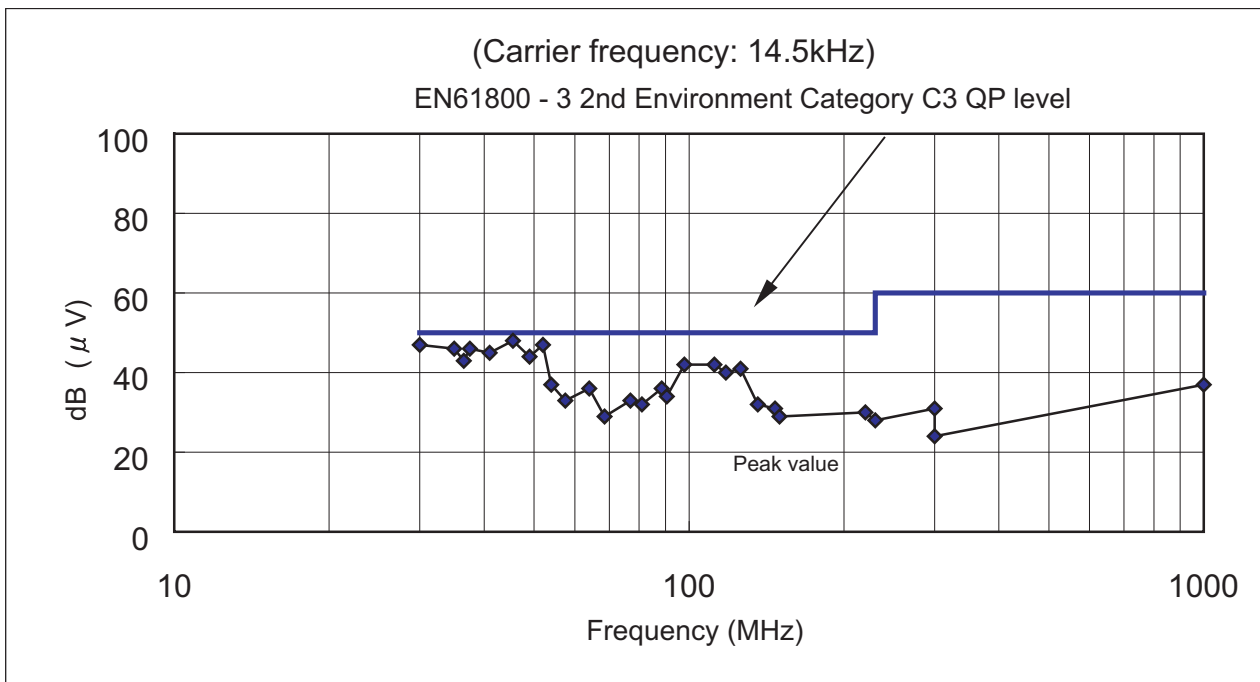

(Note) The QP value will not exceed the peak value.

• FR-D740-3.7K, FR-E5NF-H3.7K

© Conducted interference

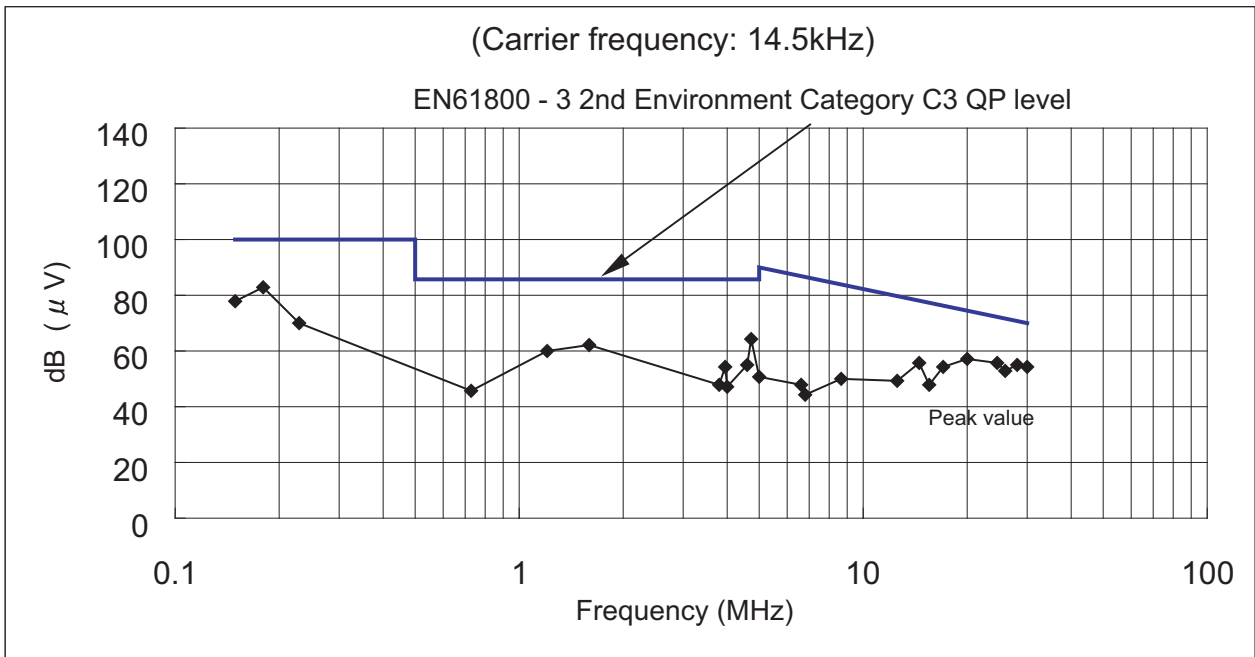

(Note) The QP value will not exceed the peak value.

© Radiated interference(10m site)

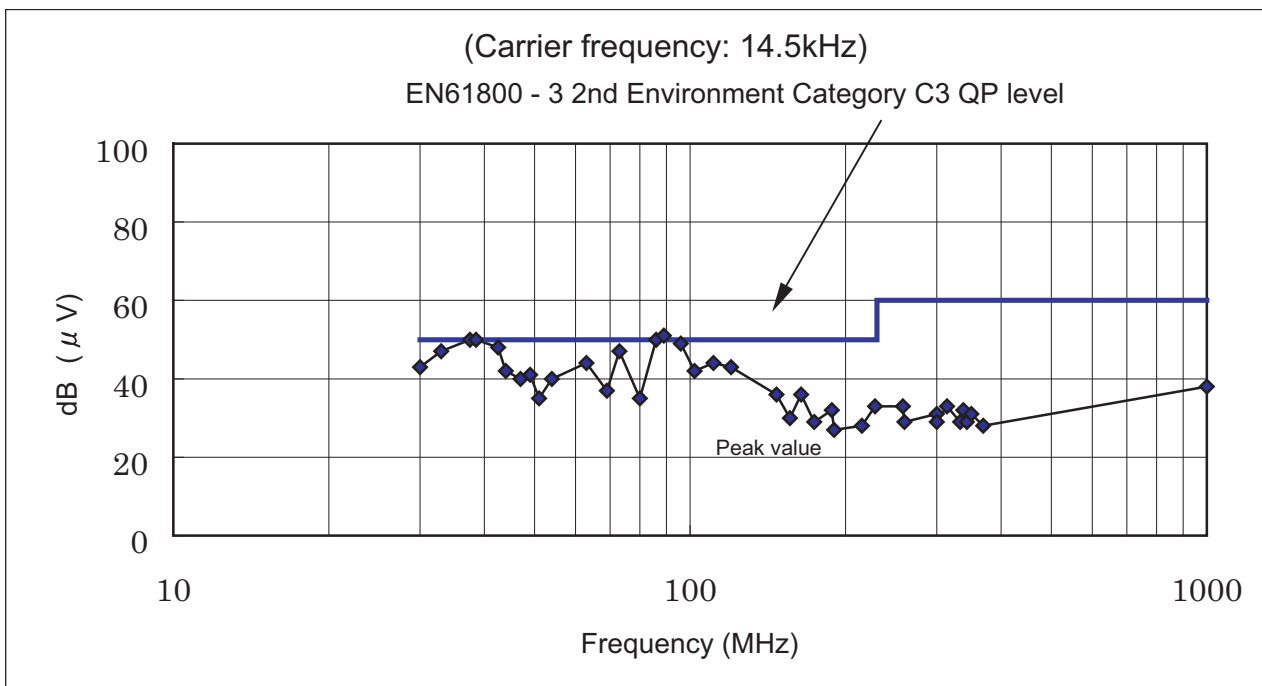

(Note) The QP value will not exceed the peak value.



• FR-D740-5.5K, FR-E5NF-H7.5K

© Conducted interference

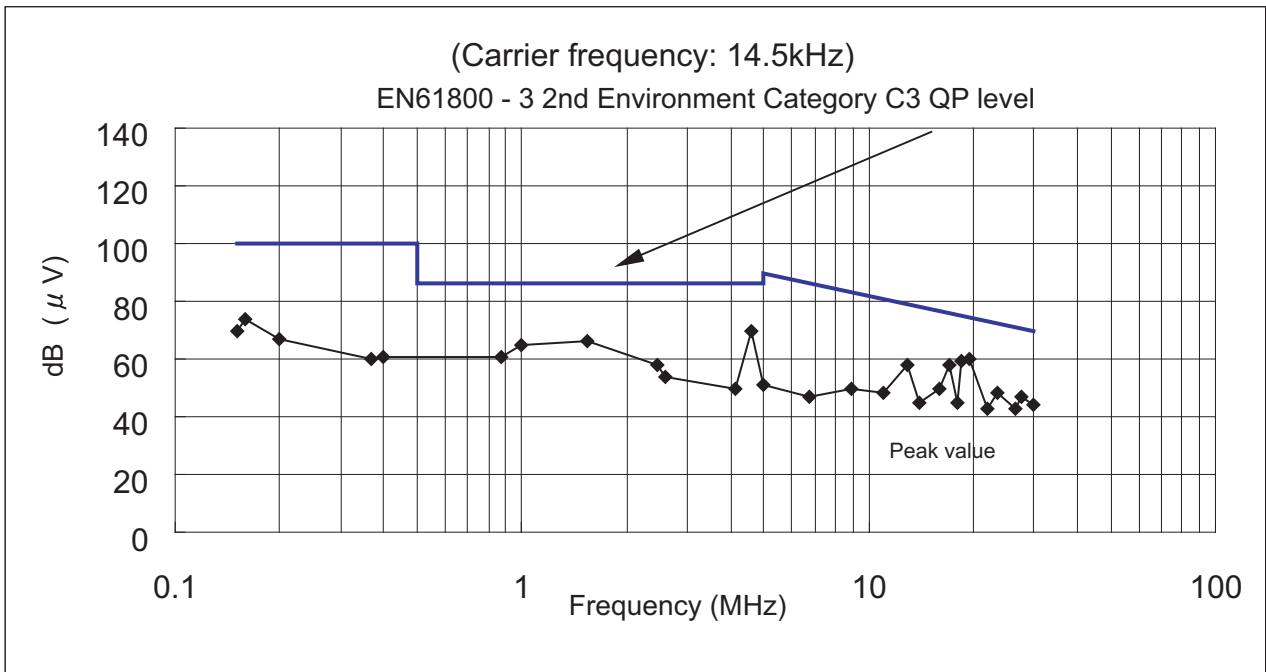

(Note) The QP value will not exceed the peak value.

© Radiated interference(10m site)

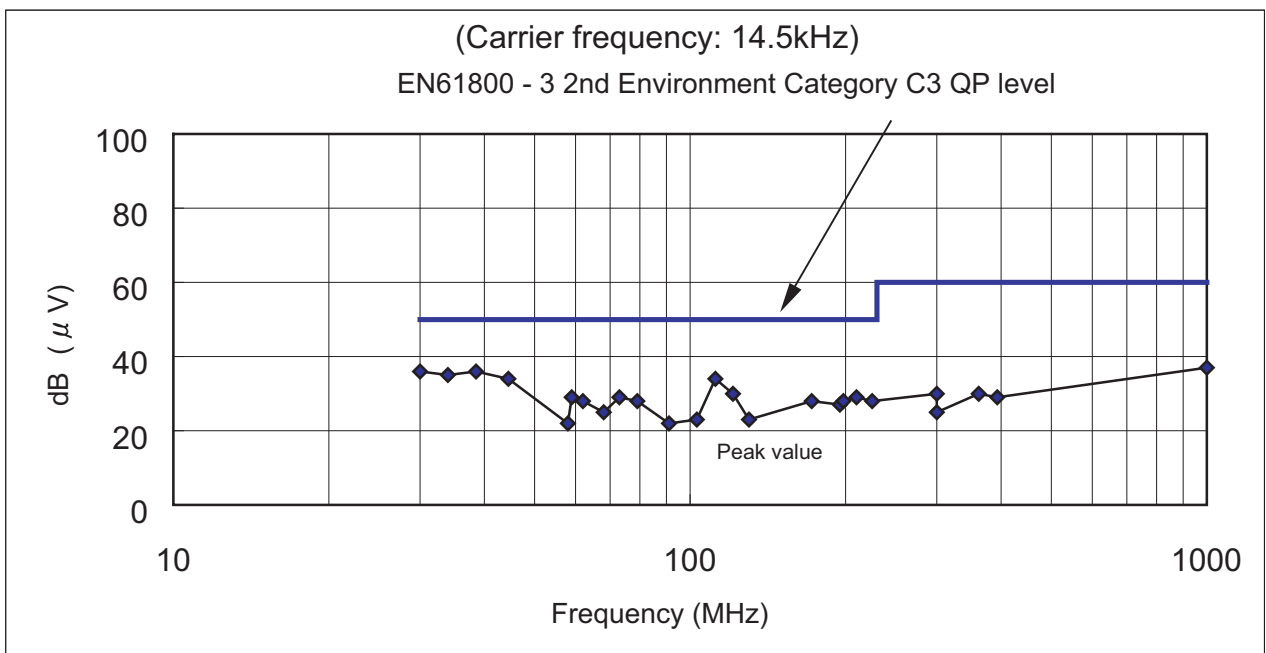

(Note) The QP value will not exceed the peak value.

• FR-D740-7.5K, FR-E5NF-H7.5K

◎ Conducted interference

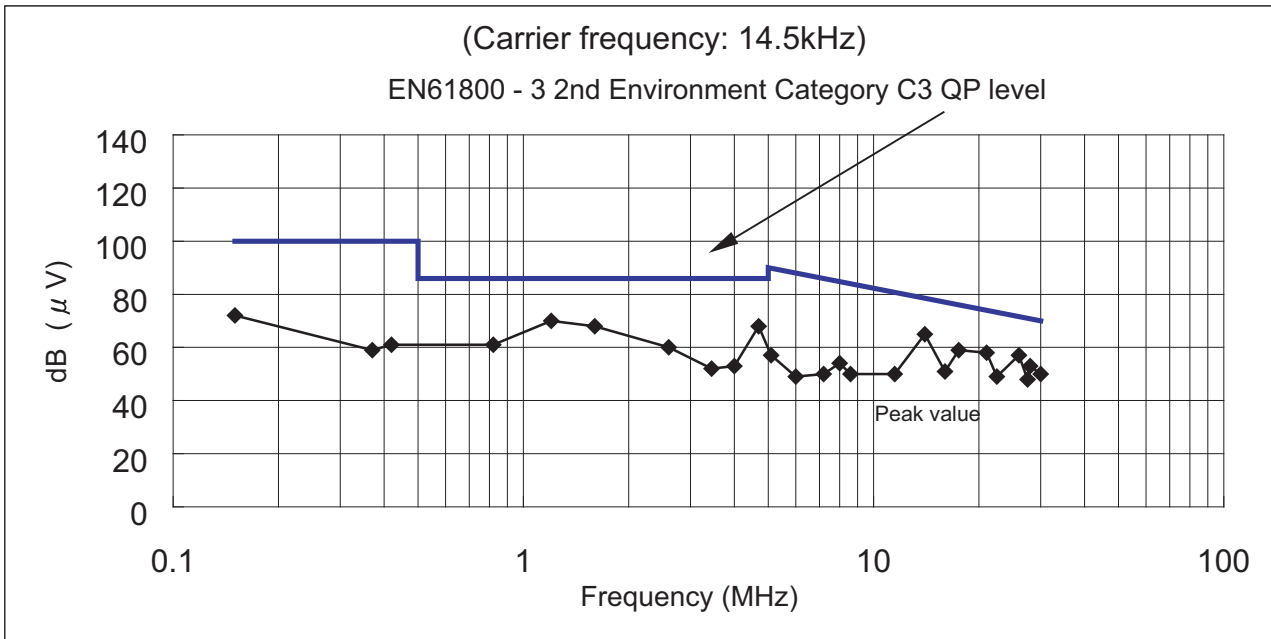

(Note) The QP value will not exceed the peak value.

◎ Radiated interference(10m site)

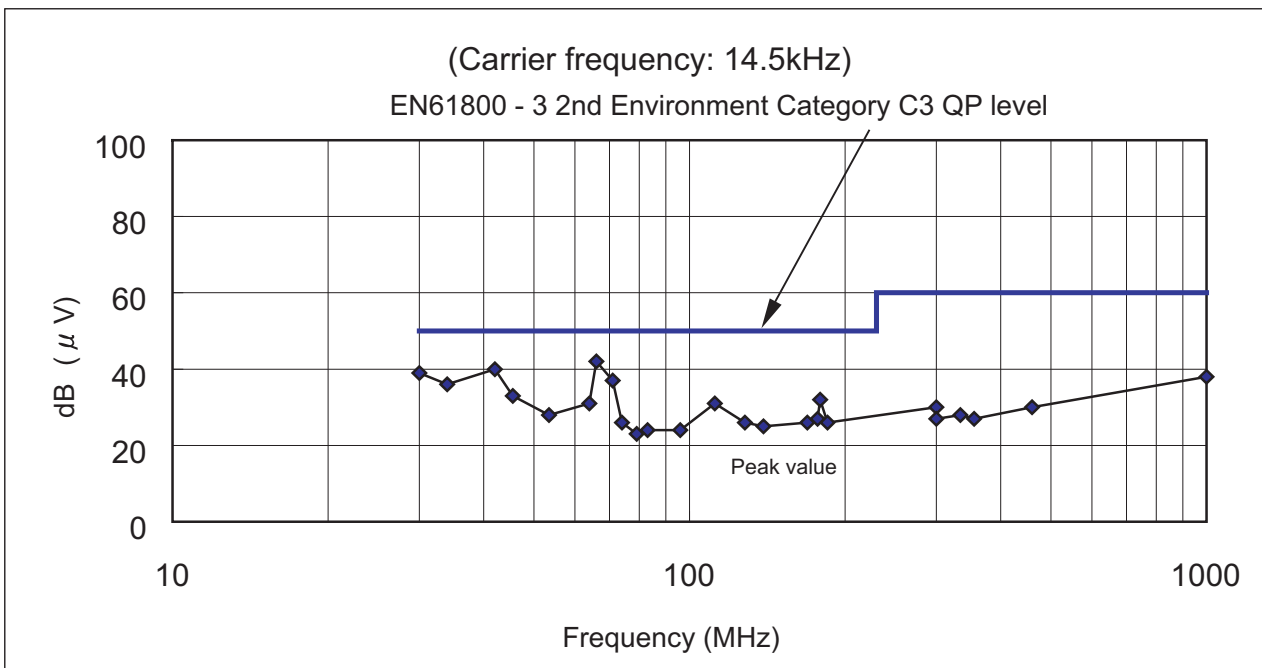

(Note) The QP value will not exceed the peak value.

# FR-D720S

## <<Conditions>>

This inverter conforms with the product standard of EN61800-3.

Measurement was conducted according to the conditions of the product standard of EN61800-3 2nd environment.

Output wire length: 20m

Operation frequency: 30Hz

Output cable: Shielded cable

Carrier frequency: Refer to the each graph

Enclosure: No-door type

For the radiated interference, ferrite core is wrapped 2 turns around the parameter unit connection cable.

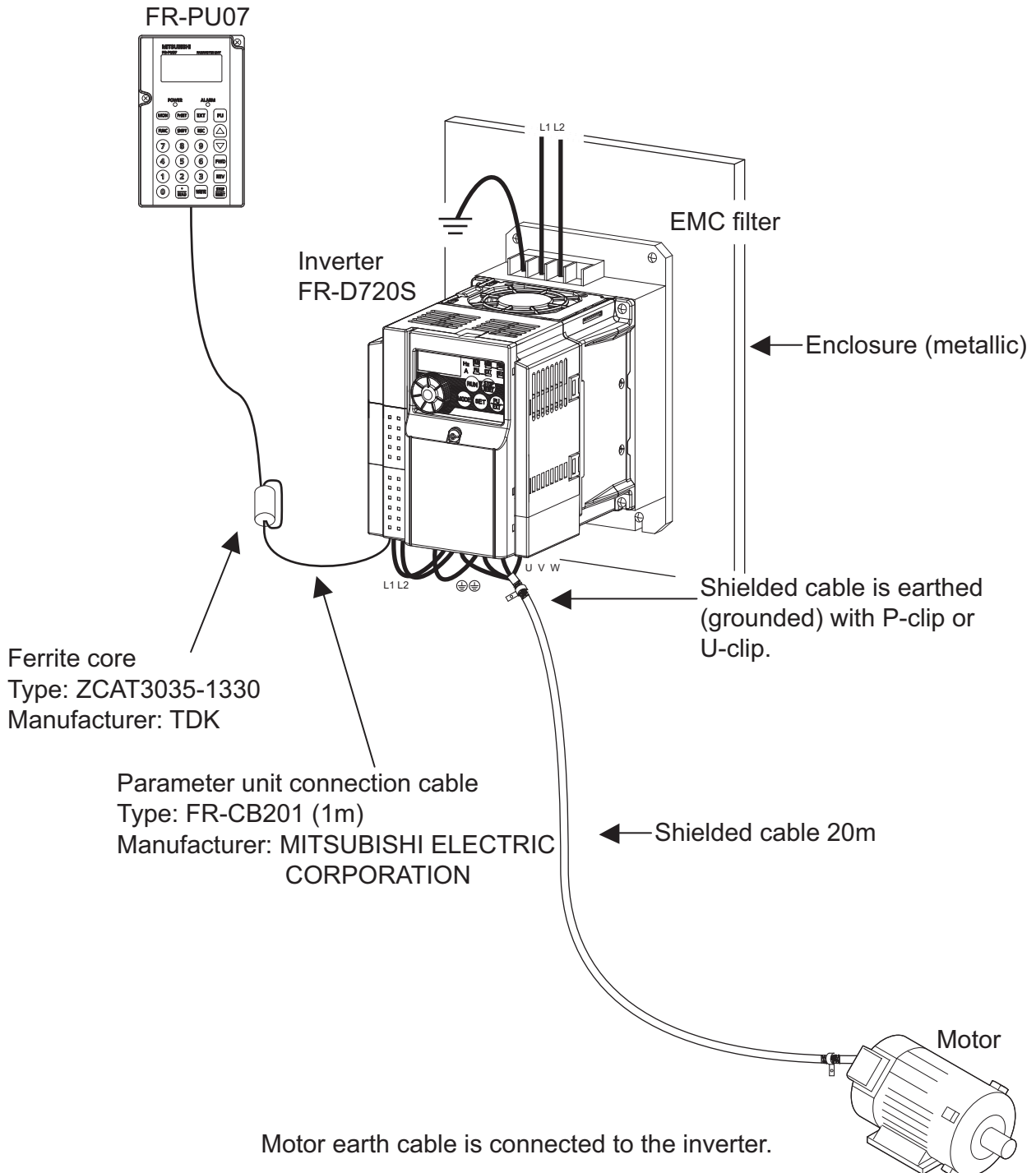

- FR-D720S-0.4K, FR-S5NFSA-0.75K

© Conducted interference

(Note) FR-BIF and FR-BSF01(2-turn) are installed in the input side.

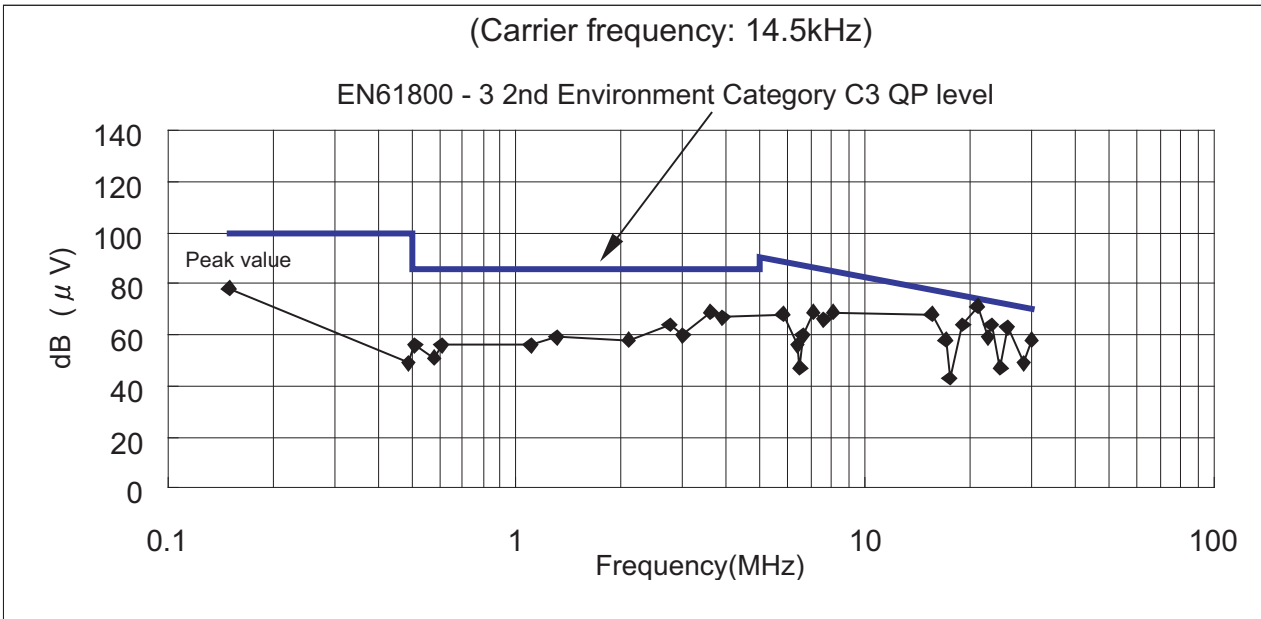

(Note) The QP value will not exceed the peak value.

© Radiated interference (10m site)

(Note) FR-BIF and FR-BSF01(2-turn) are installed in the input side.

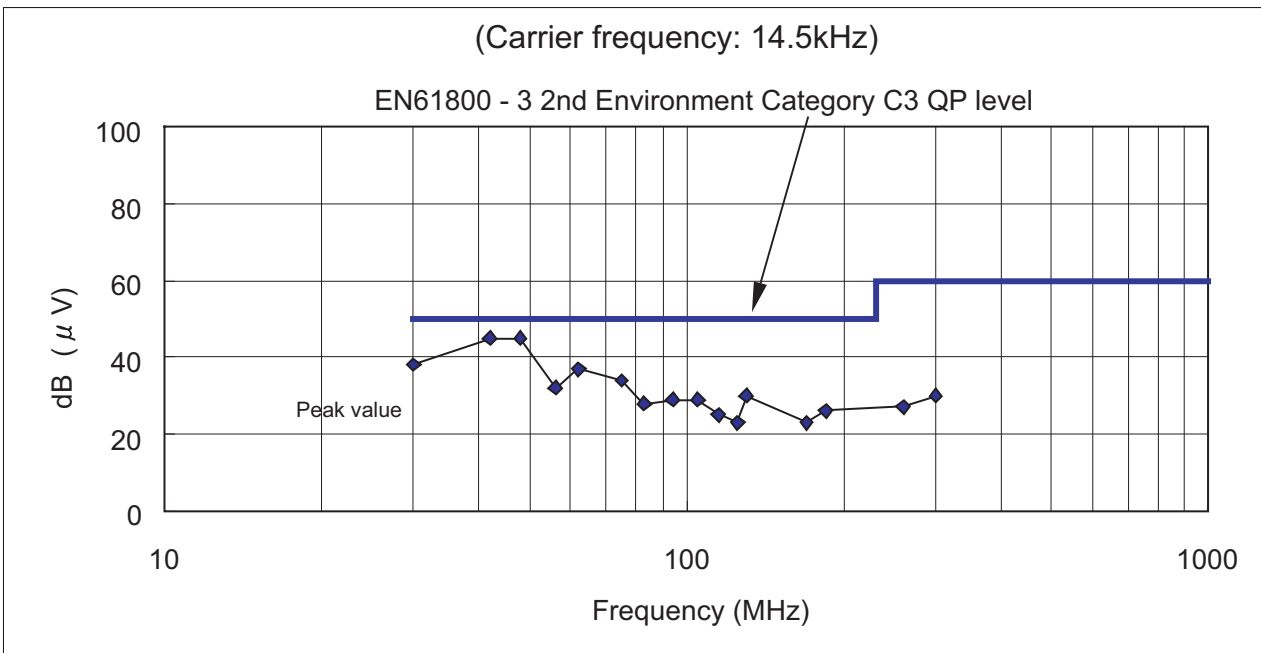

(Note) The QP value will not exceed the peak value.

• FR-D720S-0.75K, FR-S5NFSA-0.75K

◎ Conducted interference

(Note) FR-BIF and FR-BSF01(2-turn) are installed in the input side.

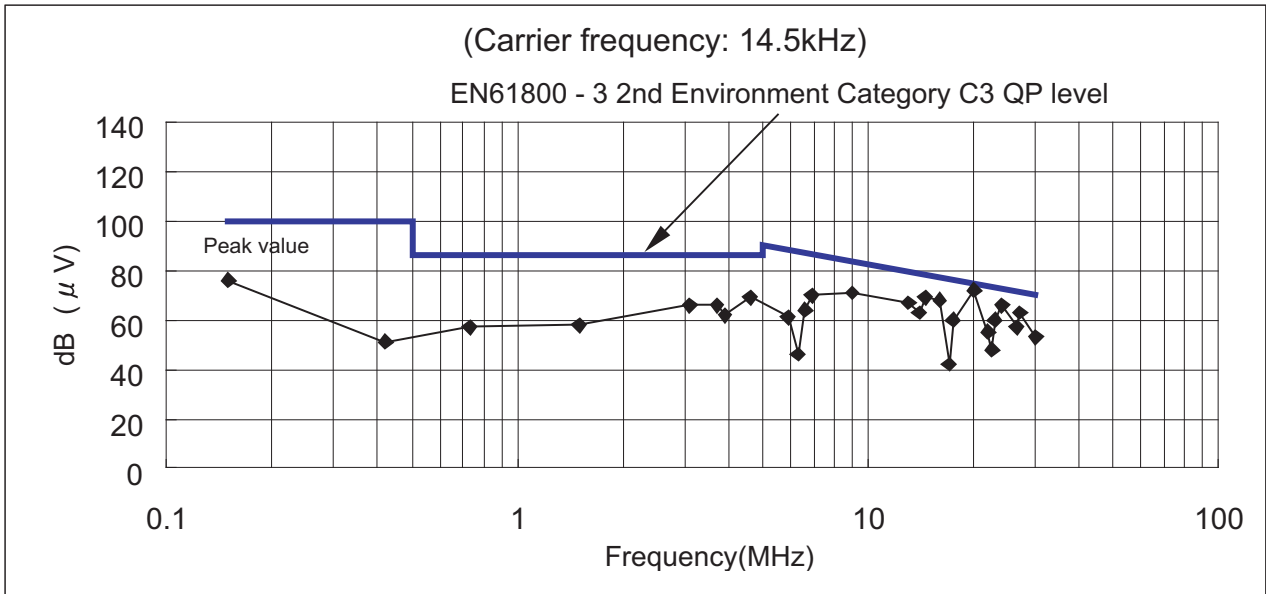

(Note) The QP value will not exceed the peak value.

◎ Radiated interference(10m site)

(Note) FR-BIF and FR-BSF01(2-turn) are installed in the input side.

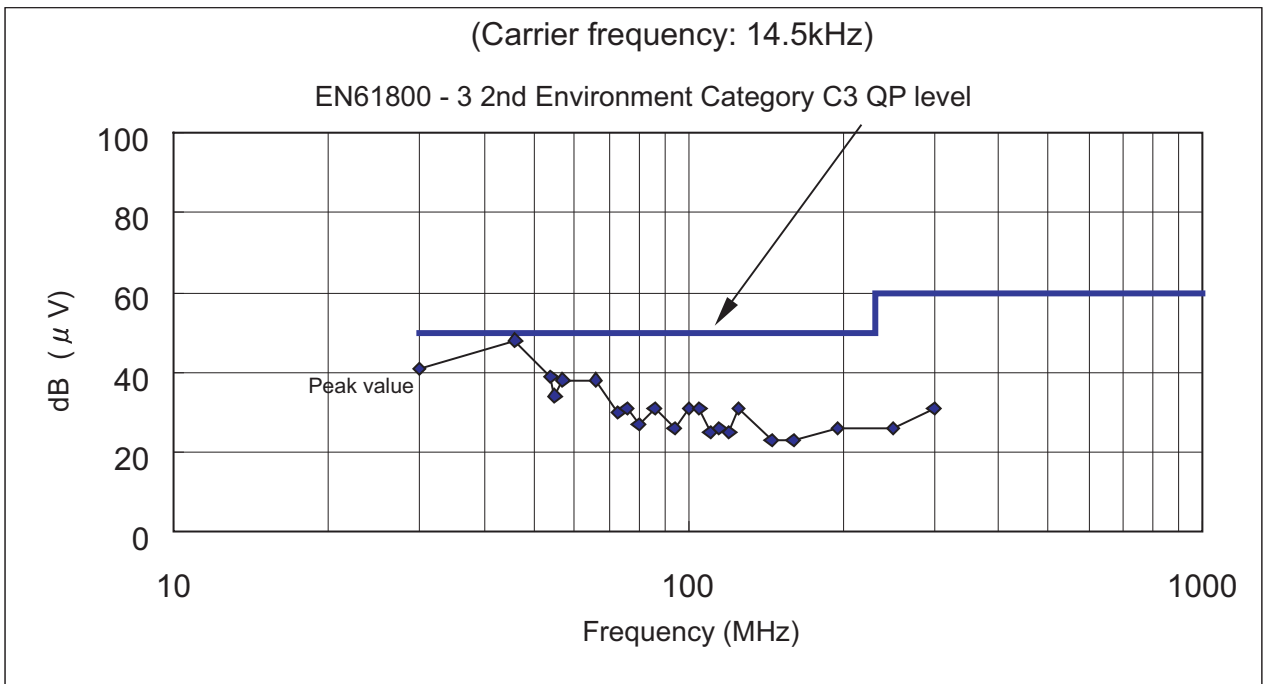

(Note) The QP value will not exceed the peak value.

• FR-D720S-1.5K, FR-S5NFSA-1.5K

◎ Conducted interference

(Note) FR-BIF and FR-BSF01(2-turn) are installed in the input side.

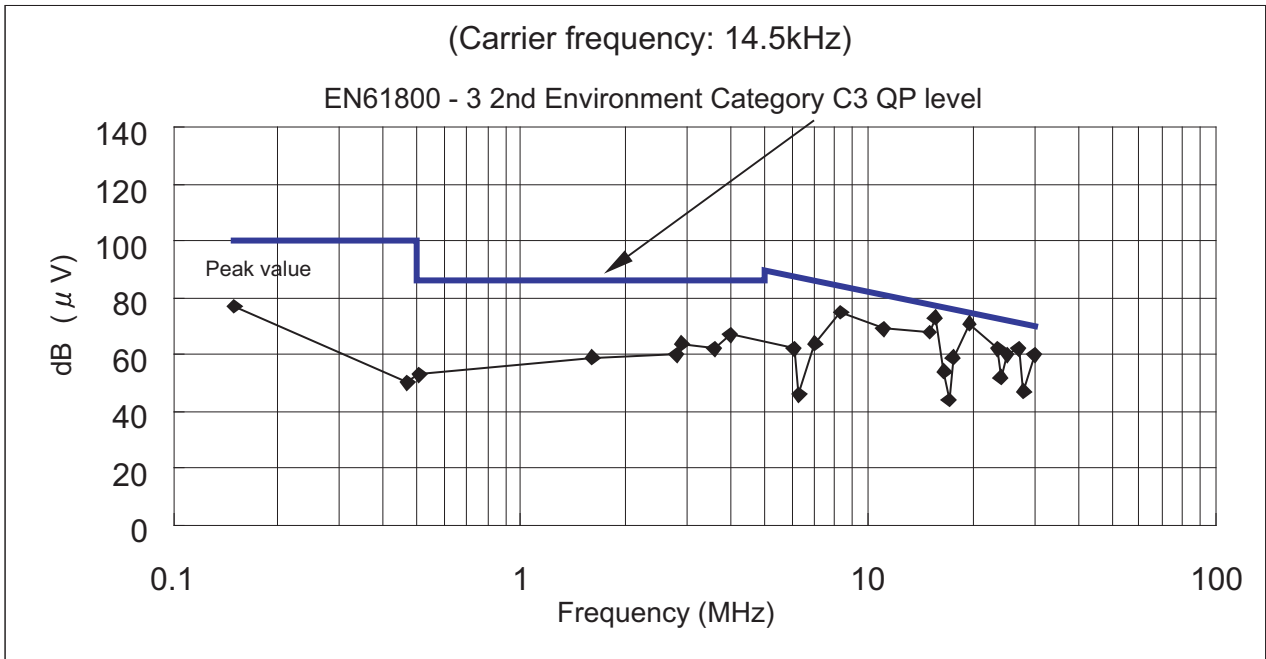

(Note) The QP value will not exceed the peak value.

◎ Radiated interference(10m site)

(Note) FR-BIF and FR-BSF01(2-turn) are installed in the input side.

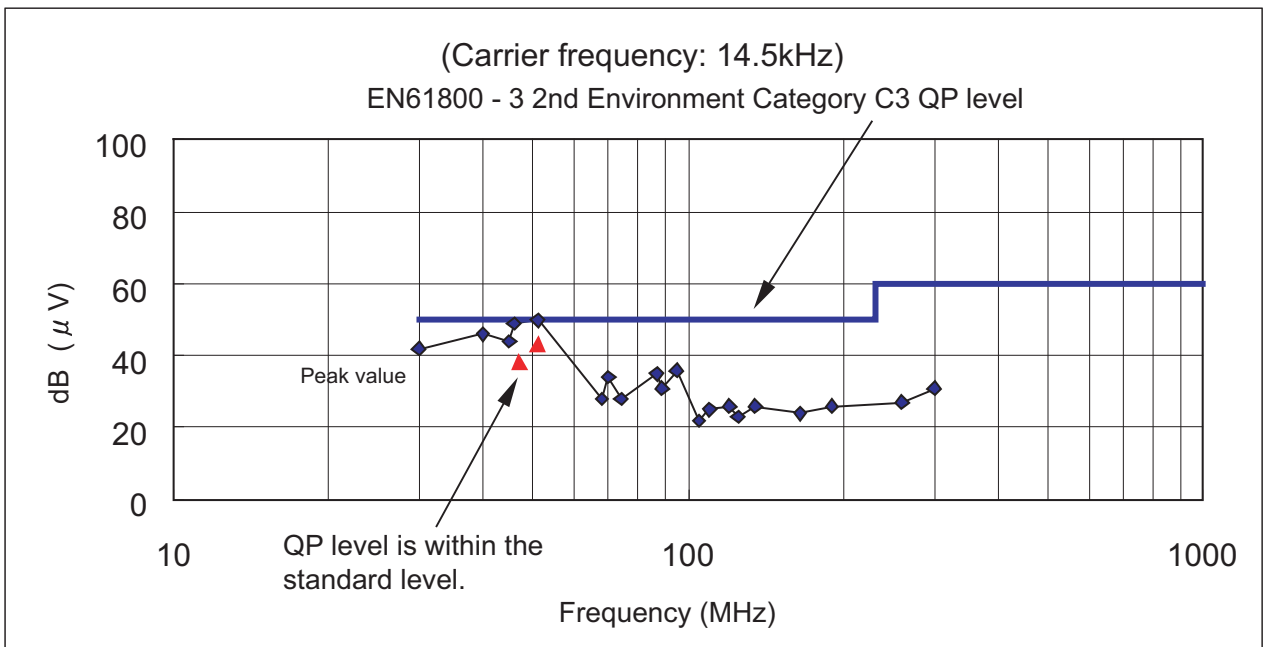

(Note) The QP value will not exceed the peak value.

• FR-D720S-2.2K, SF1309

◎ Conducted interference

(Note) FR-BIF and FR-BSF01(2-turn) are installed in the input side.

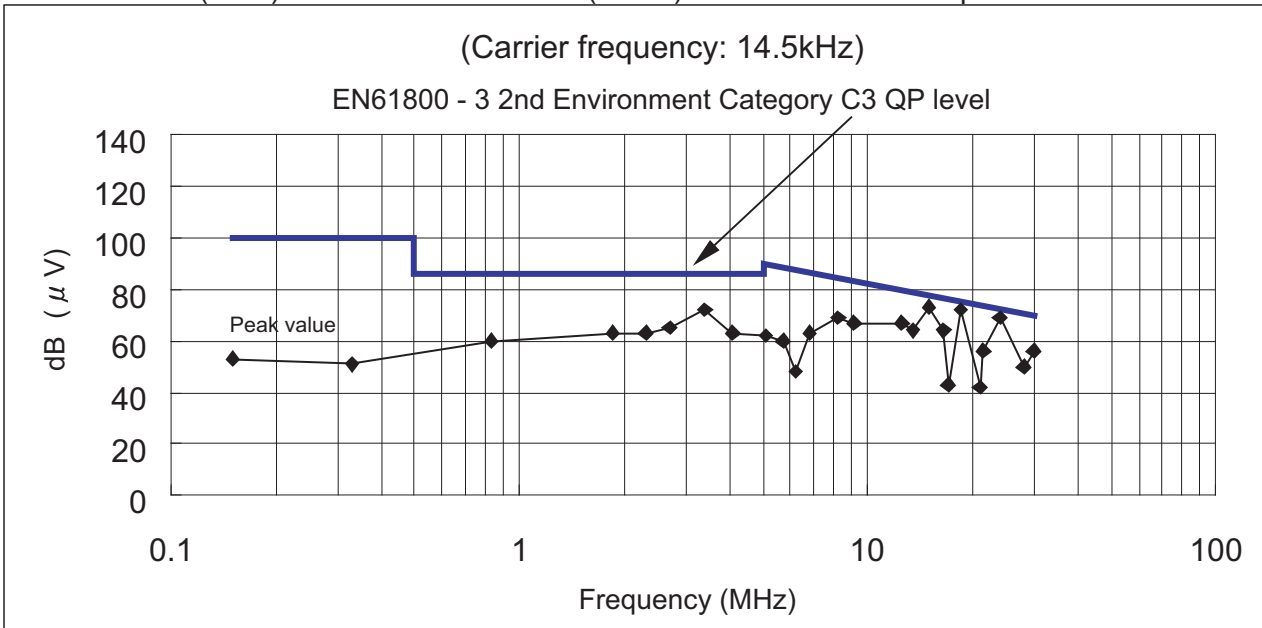

(Note) The QP value will not exceed the peak value.

◎ Radiated interference(10m site)

(Note) FR-BIF and FR-BSF01(2-turn) are installed in the input side.

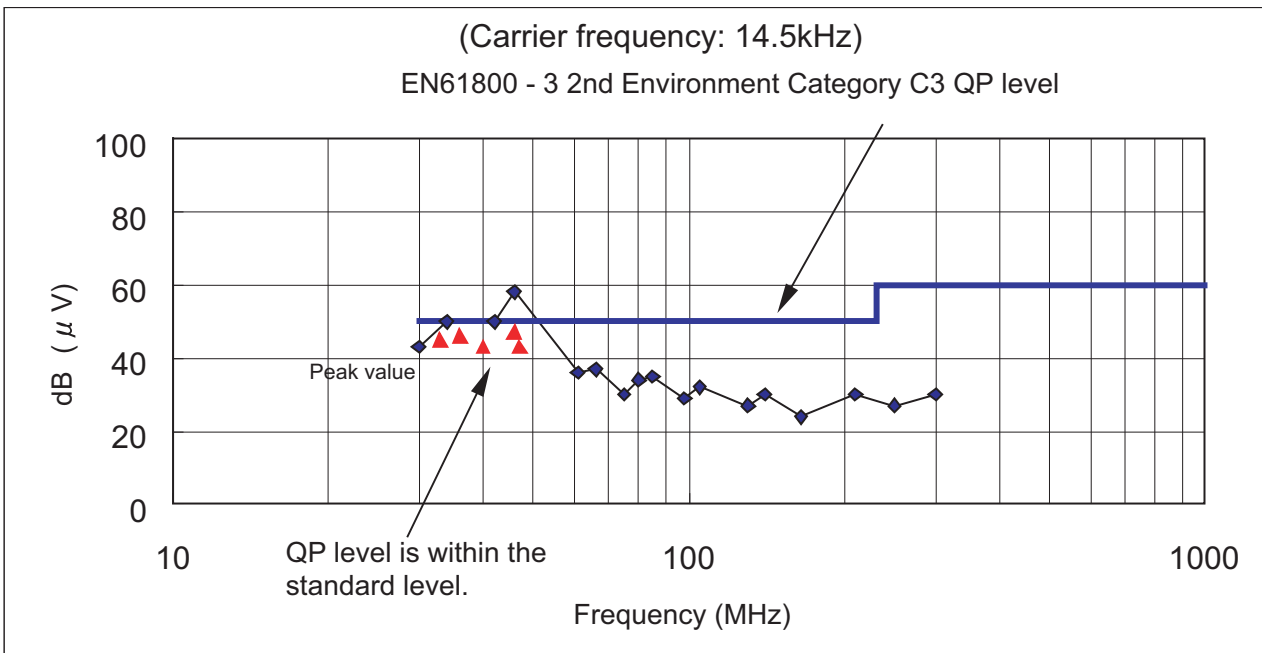

(Note) The QP value will not exceed the peak value.

