



for a greener tomorrow



**MITSUBISHI  
ELECTRIC**

*Changes for the Better*

FACTORY AUTOMATION

# TMDRIVE

MVe2 series – Energy Saving Medium Voltage Inverter



- **Very compact design**
- **Additional energy saving by regeneration**
- **Multiple input voltages available**
- **Simple commissioning, operation and trouble shooting**

# Energy Saving Medium Voltage Inverter



## Improved Productivity

**Regenerative braking is standard.** Fast acceleration/deceleration operations are available. Under sensorless vector control, high response and stable operations are available.

## Installation and Maintenance Cost Saving

**With the world's smallest class size.** The TMdrive-MVe2 has a very small footprint and height, that allows for economical transportation and installation. By using a film capacitor and a long-life fan, the inverter life cycle cost is minimized.

## Energy Saving

Application of an inverter saves energy. In addition, the TMdrive-MVe2 has high efficiency.

## Power Supply Friendly

**The TMdrive-MVe2 has very low harmonic levels and low inrush currents.**

The high input power factor contributes to an electricity cost reduction and a smaller power supply requirement for on-site power generation.

## Simple Commissioning, Operation and Troubleshooting

The Auto-tune function assists with a shorter commissioning period. Central control of multiple inverters can be performed easily with accuracy.

# Contents

---

Product introduction	<b>4-9</b>
Improved productivity	<b>4</b>
Installation and maintenance cost saving	<b>5</b>
Energy saving	<b>6</b>
Power supply friendly	<b>8</b>
Simple commissioning, operation and troubleshooting	<b>9</b>
Circuit configuration	<b>10</b>
Standard specifications	<b>12</b>
Outline dimensions	<b>18</b>

---

# Improved Productivity

## Suitable rapid acceleration/deceleration operation is available

The standard power regenerative braking function provides suitable rapid acceleration/deceleration operation with quick speed response.

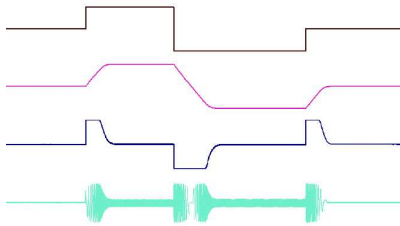

## Stable speed control without speed sensor

A speed sensor is not required. Thereby, the equipment reliability is improved. Sensorless vector control using a theory of vector operations achieves stable speed control. For applications requiring a large starting torque, vector control using sensors is also available (option).

An auto-tuning function is provided.

## Robust immunity against power supply fluctuation

Wide operable range in case of power drops. The rated voltage output is available even in case of power supply voltage drops. (Only limited by the overload capacity).

Ride-through control during an instantaneous power failure is available for a duration as high as 2 s.

When a power failure for 2 s or shorter occurs, torque output is reduced to zero without tripping, and then returns after the power recovery.

Automatic restart can be performed after the operation stops due to a power failure for 2 seconds or longer. (Automatic re-acceleration can be performed for the motors during deceleration by coasting or being stopped.)

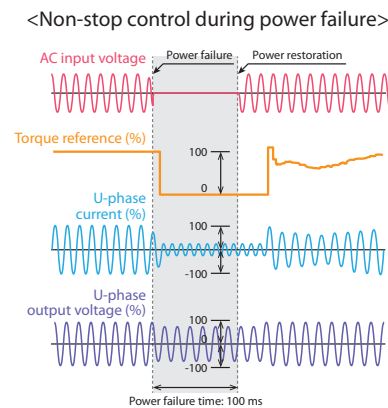

## Enhanced applications

Since the TMdrive-MVe2 output current contains extremely low harmonic content, the influence of torque ripples can be ignored. By suppressing the torsional vibration torque caused by resonance of mechanical systems, stable control is assured, achieving stable operation of machines.

TMdrive-MVe2 supports constant-torque loads, machines such as extruders or mixers, which require large starting torque, and conveyors, reciprocating compressors, and the like, which require regenerative function.

TMdrive-MVe2 can be used as a motor soft starter.

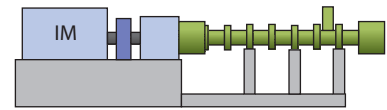

Extruder (constant-torque)

It can be used as a motor soft starter in an application with a large GD2, which may have a problem of power supply voltage drop, starting frequency, or the like when the motor is started by commercial power supply.

1 : N common soft starter is supported.

Synchronous motors can be also controlled (option).

## Short recovery time in case of failures

By using drawer type cell inverters, the MTTR (Mean Time To Repair) is as short as 30 minutes.



# Installation and Maintenance Cost Saving

## World's smallest class size\*1

The compact design of the TMdrive-MVe2 contributes to significant construction cost reduction, the enclosure height is 2100 mm for the classes up to 6.6 kV-3000 kVA\*2.

Units up to 6.6 kV-1600 kVA\*2 can be transported as a single enclosure, simplifying transport, unloading and installation. Installation is safe and straightforward as there are no shipping breaks.

For export to overseas destinations, the low-height enclosure allows transportation in general-purpose containers, enhancing convenience of transportation. Transportation costs can be reduced.

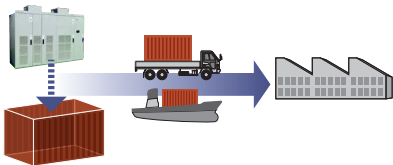

The TMdrive-MVe2 is designed for front maintenance, therefore small installation space is required.\*3

Since the input transformer and the inverter enclosure are placed side by side, external cable work is not required.

\*1: Smallest in the 6 kV class (based on the result of our survey)

\*2: Refer to page 18 for the 3 kV class and the 4 kV class. Refer to page 19 for the 11 kV class.

\*3: 11kV units require front and rear maintenance.

## Reduced load on air conditioning systems

When there is limited space in the switchroom, the input transformer can be installed externally (optional). The switchroom heating load can be reduced (by 50 %), which lightens the load to the air conditioning system. Consequently the running costs of the air conditioning system are reduced.

## Calculation examples

When the efficiency is 97 % for the 1600 kVA with the transformer externally, the heat load is reduced from 48 kW to 24 kW.

## Maintenance cost reduction

A film capacitor is used for DC smoothing. Maintenance and replacement is not necessary, which significantly reduces the life cycle cost.

Longer life of the ventilation fan can be achieved. Maintenance costs can be reduced. Conventional models: 3 years, MVe2: 7 years.

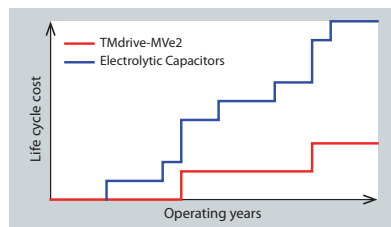

## Application to existing motors

The multilevel PWM control enables output of voltage in a waveform close to a sine wave.

By performing the proprietary switching shift control, an output filter is not required. Motors do not require surge protection.

The inverter can be easily used with existing motors without derating the motor capacity, saving the initial cost.

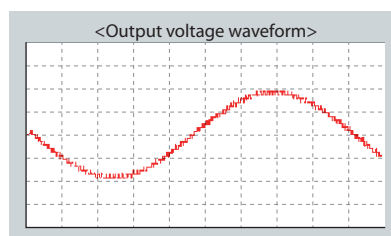

Reduction of transportation costs

## Easy wiring of control circuit

Insertion type spring terminals are used for the control circuit. The terminals are highly reliable and facilitate easy wiring. Terminals to suit ring-type crimp lugs are also available (option).

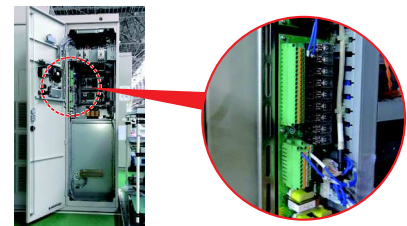

# Energy Saving



Pump, boiler and conveyor applications

## Energy saving with speed control

In variable torque load applications such as fans, pumps or blowers, variable speed operation of inverters achieves significant energy saving effect as compared to the constant speed operation using a commercial power supply (50 Hz or 60 Hz).

When motor speed control is used in applications such as a fans, pumps or blowers

$$\text{Air volume (flow)} \propto \text{Speed}$$

Required power  $\propto (\text{Speed})^3$ . For example, when 80 % air volume (flow) is required, significant power saving can be achieved by performing the speed control: Required power =  $(80\%)^3 \approx 50\%$

## Regenerative power feedback to the power supply

The power regeneration function enables stopping of large inertia loads in a short time. During deceleration, the rotational energy is returned to the power supply, which contributes to a reduction in energy consumption and a reduction in electricity costs.

### Calculation examples

A machine which decelerates with 1500 kW power in 15 minutes, with a 25 % torque

→ Each time it is stopped, power equivalent to 50 kWh is generated.\*1

\*1: Mechanical losses and losses in the motor and the inverter are not included.

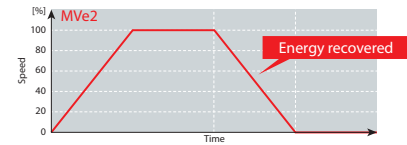

Regenerative Braking of a conveyor application allows saving of energy during each conveyor stop. Regenerative operation of downhill conveyors allows long term energy savings.

## High efficiency

The TMdrive-MVe2 has low switching losses of the main circuit elements. Low input side harmonic currents not only result in low losses, but also contributes to improvement of the efficiency of the equipment as a whole by eliminating harmonic filters or power factor improving capacitors.\*1

TMdrive-MVe2 variable speed drive system has conversion efficiency of approximately 97 %.

\*1: At rated speed and full load

<TMdrive-MVe2 efficiency curve> (with input transformer)

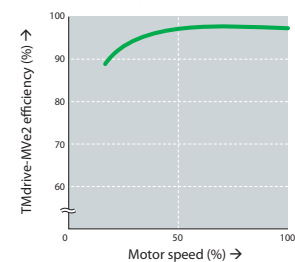

\* Example of the actual load test result of the standard 4-pole motor in our factory

## Power saving with speed control / CO<sub>2</sub> emission reduction

### Power consumption for damper control (at the rated motor speed)

The figure on the right shows a general relationship diagram when the air volume of a fan or a blower is changed from 100 % to 70 % during the damper control.

(H = 1: Rated air pressure, Q = 1: Rated air volume) The necessary shaft power P<sub>1</sub> when Q = 1 is the rated shaft power (kW) of the fan (blower). (= H0.7)

The shaft power P<sub>0.7</sub> required when Q = 0.7 (Q'0.7) is as follows when the change in efficiency of the fan (blower) is disregarded: P<sub>0.7</sub> = P<sub>1</sub> × Q<sup>0.7</sup> × H<sup>0.7</sup>. Consequently, when the motor efficiency is η<sub>M</sub>, the input power P<sub>I1</sub> when Q = 1 and the input power P<sub>I0.7</sub> when Q = 0.7 are as follows:

$$P_{I1} = P_1 / \eta_M \text{ (kW)}, P_{I0.7} = P_{0.7} / \eta_M \text{ (kW)}$$

(However, reduction in the motor efficiency due to reduction in the load rate is disregarded.)

### Power consumption for speed control of inverter

The figure on the right shows a relationship diagram when the air volume regulation of a fan or a blower is changed from 100 % to 70 % by the speed control of inverter. The input P<sub>I1</sub> required when Q = 1 is the same as that of the damper control.

$$P_{I1} = P_1 / \eta_M \text{ (kW)}$$

On the other hand, when the 70 % air volume = Q'0.7, the operation point is P'0.7. The shaft power P'0.7 required in this case is as follows:

$$P'_{0.7} = P_1 \times Q'^{0.7} \times H' = P_1 \times Q'^{0.73}.$$

Consequently, the input P'I0.7 required in this case when the inverter efficiency is η<sub>INV</sub> is as follows: P'I0.7 = P'0.7/η<sub>INV</sub>/η<sub>M</sub>

$$\eta_{INV} P_{I0.7} = P_1 \times 0.73 / \eta_M / \eta_{INV}$$

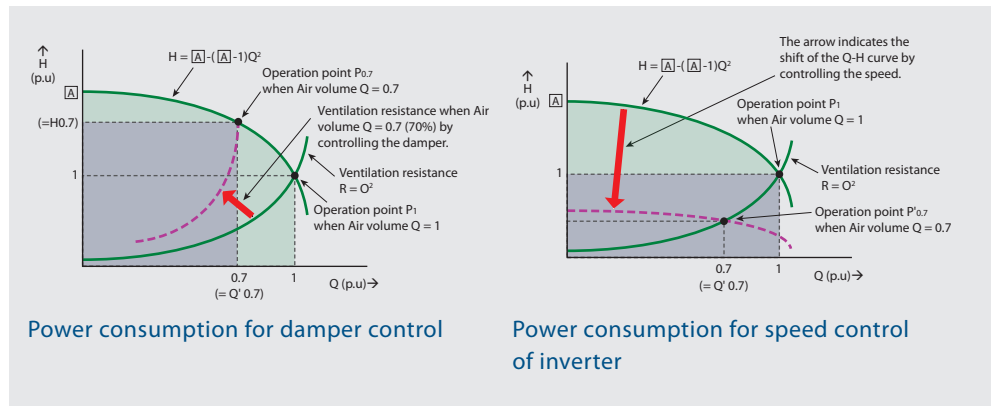

Pump, boiler and conveyor applications

## Calculation examples

- Motor efficiency = 96.5 %
- TMdrive-MVe2 efficiency = 97 % (including transformer)
- Fan shaft power at rated air volume: 1100 kW
- Fan characteristics: H (when Q = 0) = 1.4 p.u
- Annual operation time: 8000 h

Fan operation pattern

- 100 % air volume: 20 % of the annual operation time
- 70 % air volume: 50 % of the annual operation time
- 50 % air volume: 30 % of the annual operation time

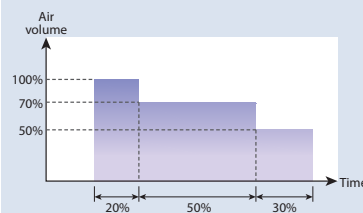

### Damper control

When P<sub>100</sub> = 100 % air volume, P<sub>70</sub> = 70 % air volume, P<sub>50</sub> = 50 % air volume,

$$P_{100} = 1100 / 0.965 = 1140 \text{ kW}$$

$$P_{70} = 1100 \times 0.7 \times$$

$$(1.4 - 0.4 \times 0.7 \times 0.7) / 0.965 = 961 \text{ kW}$$

$$P_{50} = 1100 \times 0.5 \times$$

$$(1.4 - 0.4 \times 0.5 \times 0.5) / 0.965 = 741 \text{ kW}$$

$$\text{Power consumption} = 1140 \times 8000 \times 0.2 + 961 \times 8000 \times 0.5 + 741 \times 8000 \times 0.3 = 7,446,400 \text{ kWh/year}$$

### Speed control

When P<sub>100</sub> = 100 % air volume, P<sub>70</sub> = 70 % air volume, P<sub>50</sub> = 50 % air volume,

$$P_{100} = 1100 / 0.965 / 0.97 = 1176 \text{ kW}$$

$$P_{70} = 1100 \times 0.73 / 0.965 / 0.97 = 403 \text{ kW}$$

$$P_{50} = 1100 \times 0.53 / 0.965 / 0.97 = 147 \text{ kW}$$

$$\text{Power consumption} = 1176 \times 8000 \times 0.2 + 403 \times 8000 \times 0.5 + 147 \times 8000 \times 0.3 = 3,846,400 \text{ kWh/year}$$

### Difference between the damper control and the speed control

- Power saving amount: 7,446,400 kWh - 3,846,400 kWh = 3,600,000 kWh/year
- Power cost saving: When the electric power unit price is 0.1 dollars/kWh, 3,600,000 kWh × 0.1 (dollars)/kWh = 360,000 dollars /year
- CO<sub>2</sub> reduction: When the CO<sub>2</sub> emission factor is 0.000425 t-CO<sub>2</sub>/kWh\*, 3,600,000 kWh × 0.000425 t-CO<sub>2</sub>/kWh = 1,530 ton

\* An example emission factor of Tokyo Electric Power Company, Inc. from "Emission factors by electric utility in 2007" published by the Ministry of the Environment. In actual calculations, use a factor such as an emission factor default value 0.000555 t-CO<sub>2</sub>/kWh defined in the Ordinance No. 3 of the Ministry of Economy, Trade and Industry and the Ministry of the Environment in 2006, or an emission factor by electric utility company in each year.

# Power Supply Friendly

## Input harmonic suppression

The PWM converter arrangement of the TDrive-MVe2 meets harmonic regulator's guidelines, without the use of harmonic filters.

More power supply friendly the 36 pulse system.

Current distortion limit value 5 % → 4 % (36 pulse) → 2 %\* TDrive-MVe2 achieved

As compared to the diode converter, the new model reduces harmonics in the lower order numbers, such as fifth or seventh.

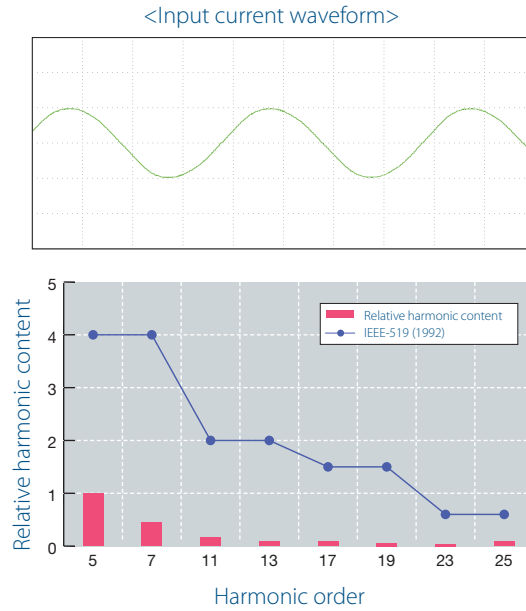

**TDrive-MVe2 relative harmonic content on the input side** (measurements in the actual load test of the 1600 kVA)

ORDER	5TH	7TH	11TH	13TH	17TH	19TH	23TH	25TH
Relative harmonic content (%)	1.0	0.45	0.16	0.08	0.08	0.06	0.04	0.08
Relative harmonic content (%)	4.0	4.0	2.0	2.0	1.5	1.5	0.6	0.6

## High input power factor

The PWM converter enables operations with a power factor 1. The basic contract charge with the electric power supplier can be reduced.

Basic charge = Unit price × Contract power × (185-Power factor)/100 As a result of the input power factor change from 95 % (diode converter) to 100 % (PWM converter), the basic charge is reduced by 5 %.

Since the equipment for power factor improvement is not required, capital investment costs can be saved. Even when the load fluctuates, stable input power factor is assured.

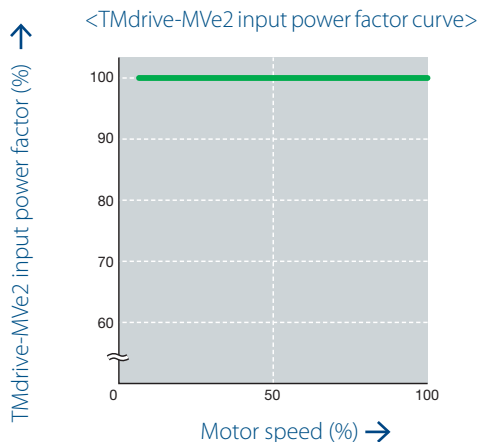

## Excitation inrush current reduction

The reactor initial charging method is applied for the 6.6 kV-1900 kVA or higher and the 11 kV to limit the excitation inrush current for the input transformer and reduce the voltage drop in the system.

Note) For installing the input transformer separately, contact your sales representative.

\* Example of the actual load test result of the standard 4-pole motor in our factory



# Simple Commissioning, Operation and Troubleshooting



An LC display is used on the operation panel.  
The inverter operating condition can be monitored on the easy-to-view display screen.  
Parameter setting and troubleshooting can be also performed easily.

### LC graphic display

- <240X64 dots, monochrome>
- Operating status display (characters/graphs)
- Fault information display (characters)
- Parameter display

### Operation status indicator (LED)

### Ethernet connector

### Operation panel



### <Main functions>

- Parameter input/change
- Display mode switching
- Local/remote switching

### Discharge check LED

### Fault reset switch

### Interlock switch

<with protective cover>

### Analog output check pins

- Current feedback output: 2 channels
- Analog output for measurement/monitoring: 5 channels

## Easy device setting/checking (option)

A high-performance display is available. It is compatible with nine languages, and has a touch panel. Anyone can check the system condition on the control panel. A variety of settings can be easily performed on the display.

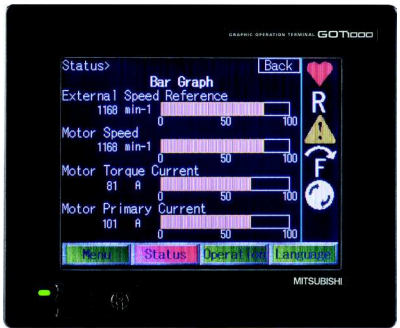

## Support function via network connection (option)

Central control of multiple devices is available in the server.

Trace data of faults can be checked in the control room. It is not necessary to

go over to the control panel. The system condition can be checked from a remote place.

By using a maintenance tool function (option), the system condition can be checked via the Internet.

Adjustment and maintenance are facilitated.

## Drive Troubleshooting

This screen displays a drive first fault and shows selected trend displays to assist in determining the cause. The fastest trend displays four variables sampled at a rate of 333 microseconds. The other two slower trends are sampled at 1 millisecond and 100 milliseconds.

### Available troubleshooting functions

- First fault display
- Operation
- Preparation display
- Fault trace back
- Trouble records
- Fault history display
- Online manual

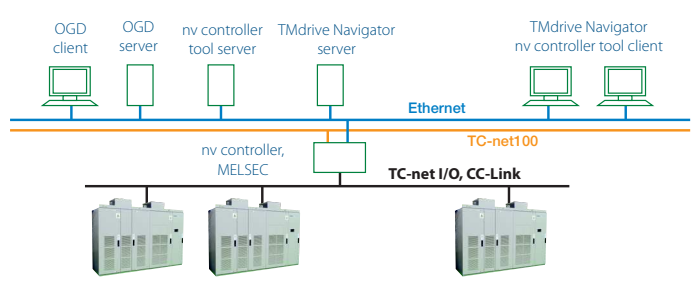

## Circuit Configuration

### Main circuit configuration diagram

The TMdrive-MVe2 consists of a dedicated input transformer and a single phase IGBT inverters (cell inverters).

Six cell inverters are connected to 3 kV/4 kV class, nine inverters to 6 kV class, and fifteen inverters to 11 kV class, which allows three-phase high voltage AC output of 3 kV, 4 kV, 6 kV, and 11 kV respectively.

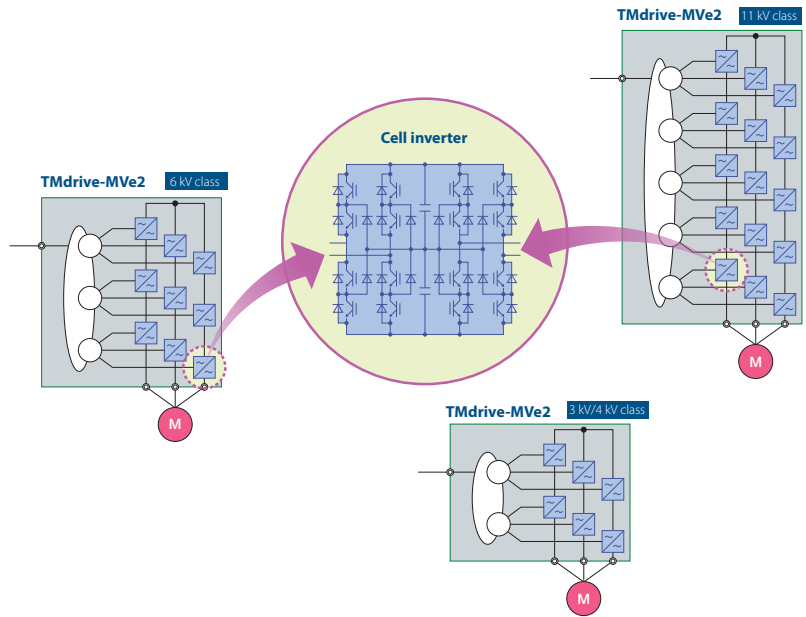

### System configuration

#### (1) Inverter individual operation



The inverter operates alone.

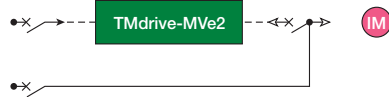

#### (2) Electronic bypass operation

Operation using a commercial power supply is also available. It is suitable for applications in which, for example, a motor is driven at a rated speed for a certain period of time, or a duplex power supply is used for a motor.

### Control block diagram

The sensorless vector control offers strong and smooth operations.

Installing 32 bit microcomputer (PP7EX2) specially designed for power electronics in MPU allows a highly reliable operation.

(The vector control with sensor is also available depending on requirements for a high quality speed control or a larger starting torque. An open loop type V/f control is also available.)

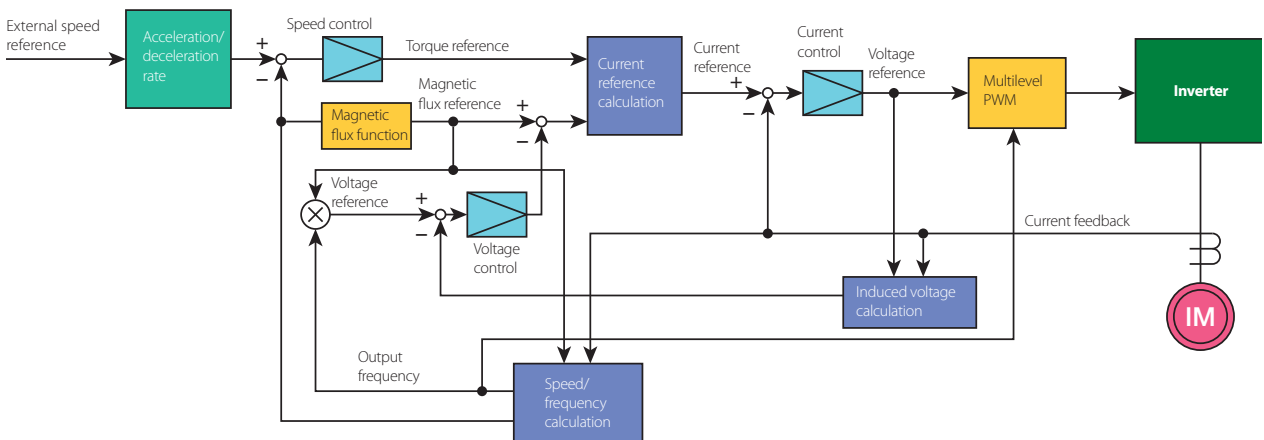

### Standard connection diagram

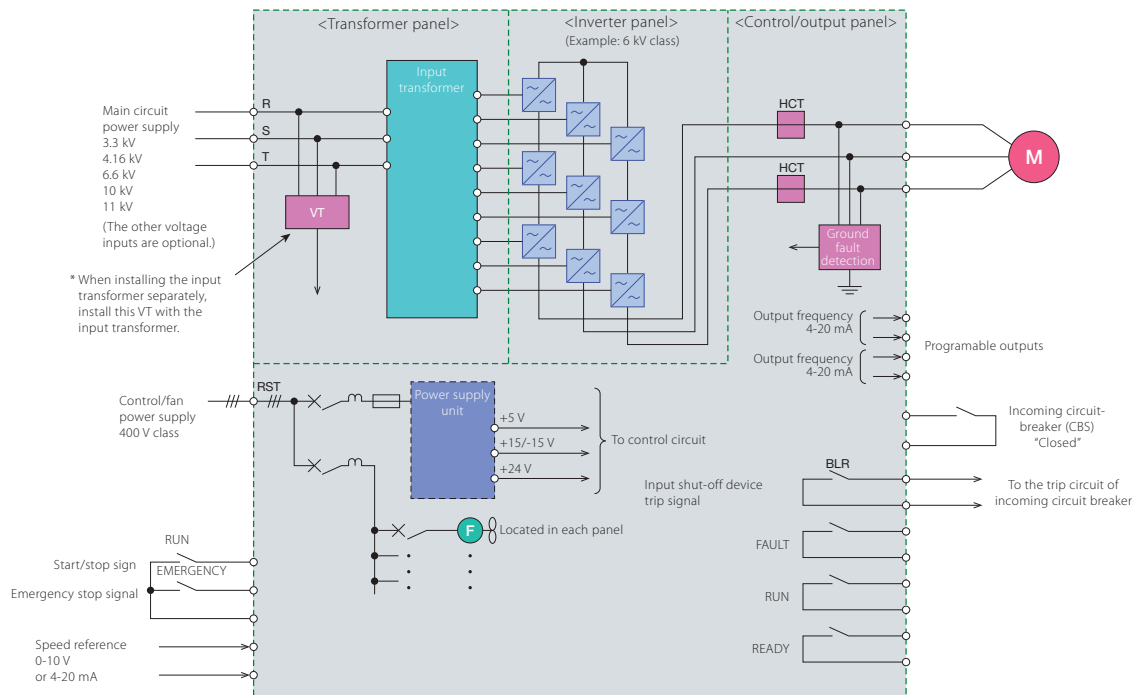

### Standard interface

CUSTOMER → INVERTER		
Main circuit power supply	Main circuit power supply	
Control/fan power supply*	Control/fan power supply	400 V/50 Hz, 440 V/60 Hz, Other options
Start/stop signal	"Closed" to operate, "opened" to stop	Dry contact: 24 V DC/12 mA
Emergency stop signal	"Closed" during normal operation, "opened" to initiate an emergency stop (coast-to-stop)	Dry contact: 24 V DC/12 mA
Incoming contactor status signal (or CBS)	"Closed" when the circuit breaker is closed	Dry contact: 24 V DC/12 mA
Output circuit breaker status signal (or CBS)	"Closed" when the circuit breaker is closed	Dry contact: 24 V DC/12 mA (if an output contactor is installed)
Speed reference signal	0-10 V = 0-100 % or 4-20 mA = 0-100 %	Input impedance 8 kΩ (0-10 V)
		Input impedance 500 Ω (4-20 mA)

\* Separate step-down transformer for the control power supply (from 400 V to 200 V) (option)

INVERTER → CUSTOMER		
Operation ready signal	"Closed" when the inverter is ready for operation	Dry contact (maximum 220 V AC/0.8 A, 110 V DC/0.2 A, 24 V DC/1.5 A)
Running signal	"Closed" when the inverter is running	Dry contact (maximum 220 V AC/0.8 A, 110 V DC/0.2 A, 24 V DC/1.5 A)
Fault signal	"Closed" when an inverter fault occurs	Dry contact (maximum 220 V AC/0.8 A, 110 V DC/0.2 A, 24 V DC/1.5 A)
Incoming circuit breaker trip signal	"Closed" when an inverter fault occurs (for tripping incoming circuit breaker)	Dry contact (maximum 220 V AC/0.8 A, 110 V DC/0.2 A, 24 V DC/1.5 A)
Output current	4-20 mA = 0-125 % current	Resistive load 500 Ω or lower
Motor speed	4-20 mA = 0-125 % speed	Resistive load 500 Ω or lower

# Standard Specifications

## Standard rating

ITEM		SPECIFICATION											
3.3/3.0 kV	At 3.3 kV output (kVA)	200	300	400	600	800	950	1100	1300	1500			
	Cell frame (frame)	100			200			300		400			
	Overload (60 seconds)	110 %											
	Rated current (A)	35	53	70	105	140	166	192	227	263			
	Applicable motor output (kW)*1	160	250	320	450	650	750	900	1000	1250			
4.16 kV	At 4.16 kV output (kVA)	500	1000	1380	1890								
	Cell frame (frame)	100	200	300	400								
	Overload (60 seconds)	110 %											
	Rated current (A)	69	138	191	262								
	Applicable motor output (kW)*1	400	810	1120	1600								
6.6/6.0 kV	At 6.6 kV output (kVA)	400	600	800	1000	1200	1400	1600	1900	2200	2600	3000	
	Cell frame (frame)	100			200			300		400			
	Overload (60 seconds)	110 %											
	Rated current (A)	35	53	70	87	105	122	140	166	192	227	262	
	Applicable motor output (kW)*1	315	450	650	810	1000	1130	1250	1600	1800	2250	2500	
10/11 kV	At 11 kV output (kVA)	660	990	1320	2000	2640	3080	3630	4290	5000			
	Cell frame (frame)	100			200			300		400			
	Overload (60 seconds)	110 %											
	Rated current (A)	35	53	70	105	139	162	191	226	263			
	Applicable motor output (kW)*1	500	800	1000	1600	2040	2500	2800	3500	3860			

\*1 Approximate value for the standard 4-pole motor

## Energy Saving Medium Voltage Inverter Family

<b>Voltage/ capacity range</b>	<b>MVG2</b>	3.3kV–200kVA to 11kV–19500kVA
	<b>MVe2</b>	3.3kV–200kVA to 11kV–5000kVA

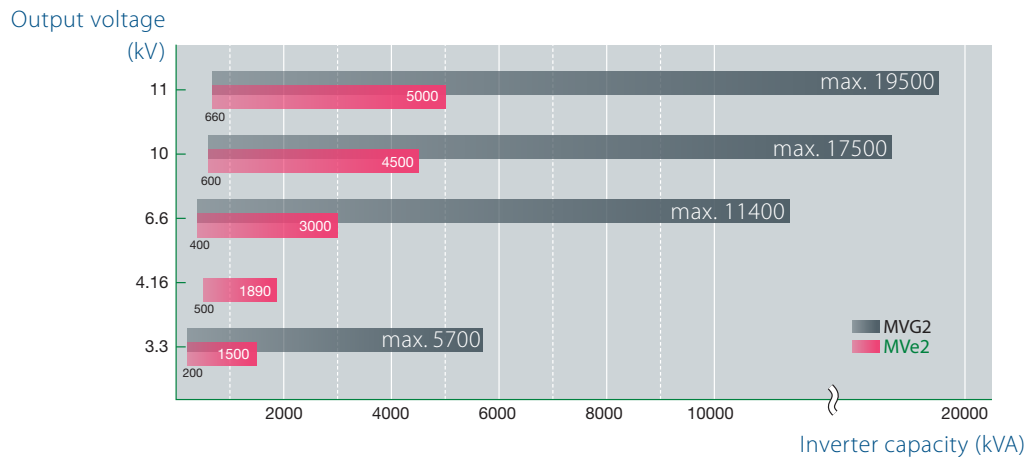

Standard specifications list

ITEM		SPECIFICATION	
Output	Output frequency (Hz)	Rated output frequency of 50 or 60 Hz	
	Overload capacity	110 % - 60 seconds	
Input	Main circuit Control/fan circuit	Three phase	3000, 3300, 4160, 6000, 6600, 10000, 11000 V - 50/60 Hz
		400 V/50 Hz, 440 V/60 Hz, Other options	
	Permissible fluctuation	Voltage: $\pm 10\%$ , frequency: $\pm 5\%$	
Input power factor/ regenerative capacity		Fundamental wave power factor of approximately $\text{pf}=1.0$ , regenerative capacity of 80 %	
Control function	Control method	Sensorless vector control, vector control with sensor, or V/f control + Multilevel PWM (Pulse Width Modulation)	
	Frequency accuracy	$\pm 0.5\%$ for maximum output frequency (for the analog frequency reference input)	
	Load torque characteristic	Variable torque load, constant-torque load	
	Acceleration/deceleration time	0.1 to 3270 seconds, individual setting possible (Setting depends on the load GD2)	
	Primary control functions	Soft stall (Programable speed reduction for fans and pumps during periods of overload), Ride-through control during instantaneous power failures, break point acceleration/deceleration function, specific frequency evasion function, continuous operation function during speed reference loss, total run time display function	
	Primary protective functions	Refer to page 14 to 16.	
	Transmission (option)	DeviceNet™, Profibus DP, Modbus® RTU, TC-net I/O, CC-Link	
Display function	Display	LCD display (240×64 dots) 4 LED indicators (READY, RUN, ALARM/FAULT, Discharge check)	
	Push buttons	NAVIGATION key, CONTROL key, Operation, stop, fault reset, interlock (drive run inhibit)	
Input transformer		Class H, dry type, TMdrive-MVe2 dedicated specifications (External options available)	
Structure	Enclosure	IP30 (except for the cooling fan opening) (Options available)	
	Enclosure structure	Steel-plate, semi-closed, self-supporting enclosure structure for a front maintenance. 11 kV requires maintenance from front and rear.	
	Cooling system	Forced air cooling by a ceiling fan	
	Finish color	Munsell 5Y7/1, leather-tone finish	
Ambient condition	Ambient temperature	0 to 40 °C (Higher temperatures with derating)	
	Humidity	85 % or less (no dew condensation)	
	Altitude	Up to 1000 m (Higher with derating)	
	Vibration	0.5 G or less (10 to 50 Hz)	
	Installation location	Indoor (free from corrosive gas, dust and dirt)	
Load pattern		Fans, blowers, pumps, compressors, extruders, fan pumps, mixers, conveyors, etc.	
Applicable standards		Electrical standards: JEC, IEC Component and others: JIS, JEC, JEM	

## Protective functions

ITEM	ABBREVIATION	CONTENT	RELATED PARAMETER
Cell converter over current	xn_C_OCA*1	The AC over current detection circuit (hardware) of the x-phase n th cell converter activated.	
Cell over voltage P side	xn_OVP*1	The P side over voltage detection of the x-phase n th cell activated.	
Cell over voltage N side	xn_OVN*1	The N side over voltage detection of the x-phase n th cell activated.	
Cell over heat	xn_OH*1	An overheat condition of the x-phase n th cell is detected.	CP_CELL_OH
Cell gate power supply failure	xn_GPSF*1	The gate power supply failure detection circuit (hardware) of the x-phase n th cell activated.	
Cell serial communication link failure	xn_LINK_F*1	Serial communication link failure of the x-phase n th cell was detected.	
Cell fuse blown	xn_FUSE*1	The fuse blown detection circuit (hardware) of the x-phase n th cell activated.	
Cell failure	xn_CELL_F*1	An x-phase n th cell failure has occurred.	
AC overcurrent	OCA	The AC over current detection circuit (hardware) activated.	CP_OCA
Over current AC B bank	OCA_B	The AC over current detection circuit (hardware) in the B bank activated.	CP_OCA
Master CPU failure	CPU_M	The watchdog failure has occurred in the main CPU of the CTR board.	
Slave CPU A failure	CPU_A	The watchdog failure has occurred in the slave CPU-A of the CTR board.	
Inverter output voltage PLL error	VPLL_ERR	Excessive phase error of the IPLL has been detected.	MS_CP_VPLL_ERR
Over voltage (soft detection)	OV_S	The drive has detected, that an inverter output voltage is greater than the over voltage protection level MS_CP_OV.	MS_CP_OV
Current failure of U-phase	CURU	The U-phase current could not be detected.	CP_CURCHK
Current failure of W-phase	CURW	The W-phase current could not be detected.	CP_CURCHK
Current failure of U-phase B bank	CURU_B	The U-phase current could not be detected.	CP_CURCHK
Current failure of W-phase B bank	CURW_B	The W-phase current could not be detected.	CP_CURCHK
Current failure of U-phase converter	CURU_CNV	When the U-phase converter starts operation, the drive checks HCTs operation of each cell. The converter current of each cell could not be detected.	CP_CURCHK_CNV TIME_CURR_CNV
Current failure of V-phase converter	CURV_CNV	When the V-phase converter starts operation, the drive checks HCTs operation of each cell. The converter current of each cell could not be detected.	CP_CURCHK_CNV TIME_CURR_CNV
Current failure of W-phase converter	CURW_CNV	When the W-phase converter starts operation, the drive checks HCTs operation of each cell. The converter current of each cell could not be detected.	CP_CURCHK_CNV TIME_CURR_CNV
Overspeed	OSS	An overspeed of the motor has been detected.	CP_OSP
Output frequency exceeded	OSS_FO	Excessive output frequency has been detected.	CS_MOTOR_FREQ CP_OSS_FO
Speed detection error	SP_ERR	A speed feedback error has been detected.	CP_SP_ERR SL_SP_ERR FLT_SP_ERR
Zero speed starting interlock	SP_SIL	Because the motor is running, a startup interlock condition cannot be made.	MA_ZERO_SP
Speed reference lost	SP_LOST	SP_LOST detects the speed reference lost. Depending on the mask setting, SP_LOST becomes one of the following during operation. (1) SP_LOST turns off the UV signal and performs a free-run stop (coast to stop). (2) SP_LOST turns off the HFD signal and performs a free-run stop (coast to stop). (3) SP_LOST turns off the READY signal and performs a slowdown stop (deceleration to stop).	CP_SP_LOST
Speed reference lost alarm	SP_LST_A	Detects the speed reference lost.	CP_SP_LOST

\*1: The character "x" shows U, V, W-phase, and the "n" shows cell's number of columns 1-6.

Protective functions

ITEM	ABBREVIATION	CONTENT	RELATED PARAMETER
Motor rotate failure	ROT_F	The motor stall has been detected.	CP_ROT_F_DIFF CP_ROT_F_EN TIME_ROT_F
Reverse rotate failure	REV_ROT_F	REV_ROT_F detected the motor was rotating in the opposite direction to the speed reference.	CP_REV_ROT
Control power source failure	CPSF	The control power supply voltage has dropped.	CP_PSF
Main power source failure	MPSF	An AC main power supply loss has been detected during operation.	CP_UVA
+15V or -15V of voltage error	PN15_F	A voltage error of +15V or -15V has been detected.	
Rectifier failure	REC_F	REC_F detected that the drive doesn't establish the DC voltage when the main AC input is on.	
Uninterruptible power supply unit error	UPS_ERR	The control power supply failure detected, in an optional system, that the uninterruptible power supply unit (UPS), supplying the control power, failed.	FLG_UPS_USE
AC input circuit breaker open	AC_P_T	The input AC circuit breaker (AC_MCCB) is open.	TIME_AC_P
Electrical condition	UV_MPSF	An AC main power supply loss has been detected during operation.	CP_UVA
AC main voltage drop	UVA_SIL	An AC main power supply loss has been detected.	CP_UVA
Overload (5 minutes) RMS	OL5	The RMS AC current has exceeded the set value for 5 minutes.	CP_RMS_5
Overload (20 minutes) RMS	OL20	The RMS output current has exceeded the set value for 20 minutes.	CP_RMS_20
Equipment overload alarm	OL_A	The RMS AC current has exceeded the set value for 5 minutes.	CP_RMS_A
Current limit timer	CL_T	The detection of operation above a current limit has continued for the time set with the timer, TIME_CL. The value to be compared with the threshold is a result of an integral calculation using the internal time counter. The counter will start on the following condition; The Current Feedback I1_F > LMT_I1 - 5%	TIME_CL
Current limit timer alarm	CL_TA	An operation under the current limited condition continued for up to 80% of the time set with the current limit timer TIME_CL_A. (The value to be compared with the threshold is a result of integral calculation using the internal time counter. The counter will start on the following condition; The Current Feedback I1_F > LMT_I1 - 5%)	TIME_CL
Converter overload (5 minutes) RMS	OL5_B	The RMS converter current has exceeded the set value for 5 minutes.	CP_RMS_CNV5
Converter overload (20 minutes) RMS	OL20_B	The RMS converter current has exceeded the set value for 20 minutes.	CP_RMS_CNV20
Converter overload alarm	OL_A_B	The RMS converter current has exceeded the set value for 5 minutes or 20 minutes.	CP_RMS_CNV5A
Converter Current limit timer	CL_T_B	The detection of operation above a current limit has continued for the time set with the timer. The value to be compared with the threshold is a result of an integral calculation using the internal time counter. The counter will start on the following condition; The Current Feedback I1_F_B > LMT_I1_B - 5% after this value reaches to the timer value TIME_CL.	CP_RMS_CN-V20A
Converter current limit timer alarm	CL_TA_B	An operation under the current limited condition continued for up to 80% of the time set with the current limit timer. (The value to be compared with the threshold is a result of integral calculation using the internal time counter. The counter will start on the following condition; The Current Feedback I1_F_B > LMT_I1_B - 5%)	
Automatic speed reduce operating in overload	SOFT_STL	The operation is in soft stall mode due to an overload or high temperature.	CR_SOFT_STALL FLG_SOFT_STALL
Equipment ventilating fan stopped timer	C_FN_T	Abnormal status of the equipment ventilating fan continued for the length of time set with the timer TIME_CFAN.	TIME_CFAN
Equipment ventilating fan stopped	C_FN	An equipment ventilating fan error has been detected. This detection is made by an auxiliary contact of the fan MCCB.	

## Protective functions

ITEM	ABBREVIATION	CONTENT	RELATED PARAMETER
Equipment ventilating redundancy fan stopped timer	C_FN_B	A redundant equipment ventilating fan error has been detected. This detection is made by an auxiliary contact of the fan MCCB.	
Ground detection timer	GR_T	A ground fault has been detected.	CP_GDV TIME_GR FLT_GDV
Ground detection alarm	GR_A	GR_A detects when the ground current increases above the ground detection alarm level.	CP_GDV_A FLT_GDV
DC voltage drop	UVD	A Power supply voltage drop was detected in the DC main circuit while the drive was running.	
DC voltage drop starting interlock	UV_SIL	The DC voltage is equal to or less than 75% and the drive is not allowed to start.	
System configuration error	SYS_ERR	A system configuration setting error has been detected. The drive turns off the UVA signal. The DIP switch (SW1) of the CTR board are not correct.	
Set parameter check error	PARA_ERR	This is a checksum error of parameter setting value.	
External interlock	IL	An external interlock signal has been lost.	
External equipment electrical condition ready condition	UVA_EX	UVA_EX is an external electrical condition signal.	
External safety switch	UVS	The "operation interlock switch input", from outside the master cubicle, is off.	FLG_UVS2_USE
Panel interlock switch on	P_SW	The interlock switch on the cubicle is in "Operation prohibited" (lamp lit) status.	
AC contactor fault	ACSW_F	The contactor on the load side was open during operation.	
AC contactor opened timer	ACSW_T	The contactor on the load side is open.	TIME_CTT
AC contactor closed	ACSW_C	The contactor on the load side is closed although it is not turned on.	
Output side open	NO_LOAD	An open load has been detected. The drive turns off the UVA signal and stops. The NO_LOAD signal is generated when the feedback current becomes one eighth or less of the excitation current.	
Overheat transformer	OH_TR	An overheat condition of the transformer has occurred.	CP_OH_TR
Input transformer high temperature alarm	OH_TR_A	The overheat alarm of the input transformer panel tripped.	CP_OH_TR_A
ACL overheat timer	OH_ACL_T	The ACL overheat condition continued for the length of time set with the TIME_ACL timer.	TIME_ACL
ACL overheat	OH_ACL	An ACL overheat has been detected. If the operation continues, "OH_ACL_T" will operate.	
General analog input signal lost fault	AIN_FAULT	Current signal fell lower than 4mA when using the 4-20mA current type general analog input.	
Input voltage phase loss detection	VAC_PH_LOSS	Input AC voltage phase loss has been detected.	CP_VAC_PH_LOSS
Output Current phase loss detection	VINV_PH_LOSS	An Output AC current phase loss has been detected.	CP_VINV_PH_LOSS
Input voltage phase rotate failure	VAC_ROT_F	Incorrect input AC voltage phase rotation has been detected.	
Voltage Feedback failure	VFBK_F	A failure of the output Voltage of the inverter has detected.	CP_VFBK_F CP_VFBKF_L_LIM FLT_VFBK_F
Voltage feedback failure alarm	VFBK_F_A	A failure of the output Voltage of the inverter has detected.	CP_VFBK_F_A CP_VFBKF_L_LIM FLT_VFBK_F
Pre-charge contactor failure	PRE_CTT_F	An error was detected in the contactor of the pre-charge circuit.	
Pre-charge contactor opened	PRE_CTT	The contactor of the pre-charge circuit is open. When the UVS signal is off or there is no DC power, the contactor of the pre-charge circuit would not be closed.	



## Option

ITEM	ABBREVIATION
Output frequency	Maximum output frequency for 3 kV/4 kV/6 kV: 120 Hz, for 11 kV: 72 Hz
Control method	Vector control with sensor (encoder)
	Automatic restart control after power failure (between 2 seconds and 6 seconds), synchronous transfer to and from commercial power supply (shock-less switching over between power supplies)
Maintenance tools	Personal computer application software for maintenance and adjustment (OS: Windows®7 Professional 32-bit version)
Others	Multi-language display on the operation panel (supports nine languages), SM control, soft start, separate step-down transformer for the control power supply (from 400 V to 200 V), duplex cooling fan
	Specified painting color
	Outlet, control panel illumination light, space heater, separate input transformer, excitation inrush current limit circuit (small-capacity)

\* For installing the transformer separately or using the excitation inrush current limit circuit, contact your sales representative for the enclosure size.  
 For the 3 kV class and the 4 kV class, if it is required to store a step-down transformer for control power supply, have a duplex cooling fan, lead the external cable in from the upper side, have outlets, in-enclosure lightings, and space heaters, or install the transformer separately, contact your sales representative.

## Inverter selection guide

### Items to be informed

Please designate the following items on your inquiry.

**1) Application**

- Equipment name

**5) Main circuit input voltage/frequency**

V –
Hz

**2) Load type**

- Fan, blower, pump, compressor, etc.

**6) Control/fan power supply voltage/frequency**

- Three-phase three-line: V – Hz

**3) Torque characteristics**

- Square variable-torque, constant-torque, with constant output range, etc.
- $GD^2$  of the load (Motor axis conversion): kgm<sup>2</sup>
- Required overload capacity: % – second
- Speed-torque curve of the load:
- Necessary starting torque: %

**7) Range of operating frequency**

Hz to
Hz

**8) Operating frequency setting**

- Automatic signal <4 to 20 mA>, manual setting on the operation panel, speed increase/decrease signal, etc.

**4) Driving motor**

- New or existing
- Power output: kW
- Number of poles: P
- Voltage: V
- Speed: min<sup>-1</sup>
- Rated frequency: Hz
- Rated current: A

**9) Commercial bypass operation**

- with  without

**10) Installation condition**

- Ambient temperature: to °C
- Humidity (no dew condensation): %
- Air conditioning systems:  with  without
- Space limitation for transportation on site:

### Inverter capacity calculation

If the rated current of the motor that the inverter is going to drive is I (A), and the related voltage V (kV), the necessary capacity of the inverter (kVA) is calculated by Inverter capacity (kVA) =  $\sqrt{3} \times V \times I \dots (1)$ .

The capacity of inverter must be larger than the capacity calculated from (1).

Additionally, the inverter capacity on the standard specifications list is printed at 3.3 or 6.6 kV output. For the inverter capacity at 3 or 6 kV output, it requires multiplying 0.9.

## Outline Dimensions

**3.3 kV–200/300/400 kVA**  
**4.16 kV–500 kVA**

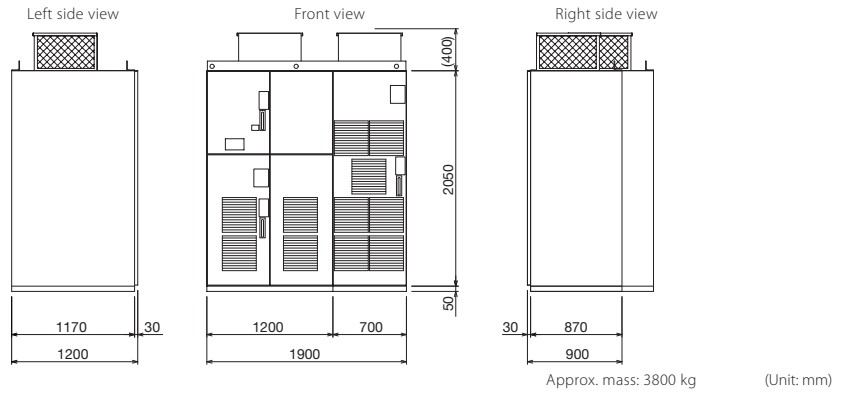

**3.3 kV–600/800 kVA**  
**4.16 kV–1000 kVA**

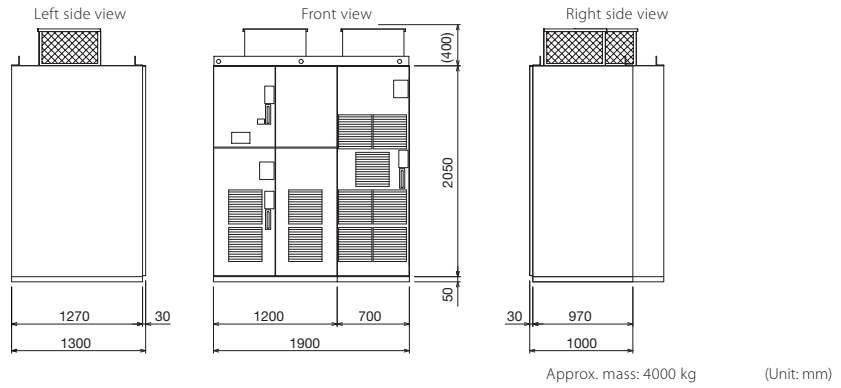

**3.3 kV–950/1100kVA**  
**4.16 kV–1380 kVA**

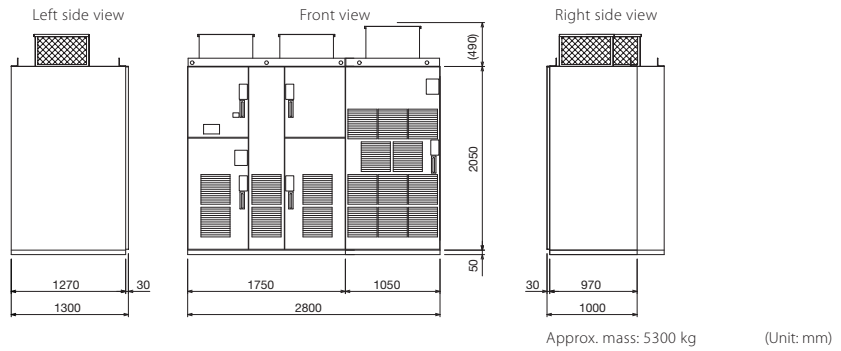

**3.3 kV–1300/1500kVA**  
**4.16 kV–1890 kVA**

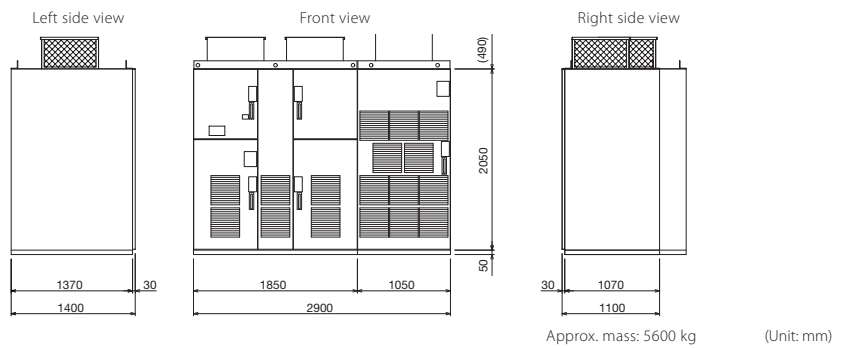

6.6 kV-400/600/800 kVA

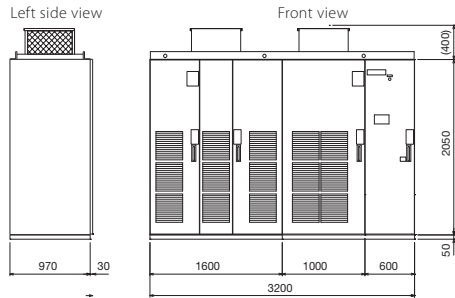

Approx. mass: 3400 kg

6.6 kV-1000/1200/1400/1600 kVA

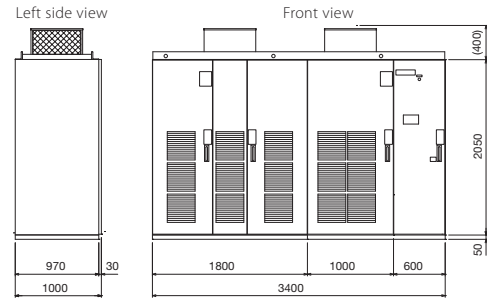

Approx. mass: 4700 kg

(Unit: mm)

6.6 kV-1900/2200/2600/3000 kVA

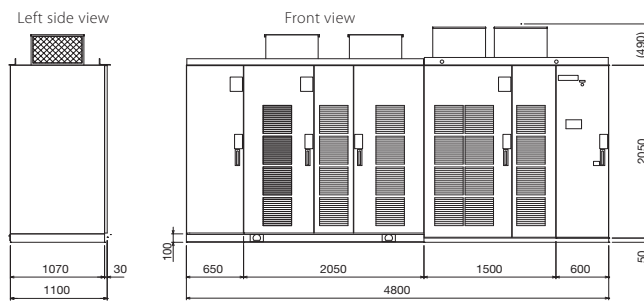

Approx. mass: <1900/2200 kVA> 6750 kg  
<2600/3000 kVA> 7150 kg

(Unit: mm)

11 kV-660/990/1320/2000/2640 kVA

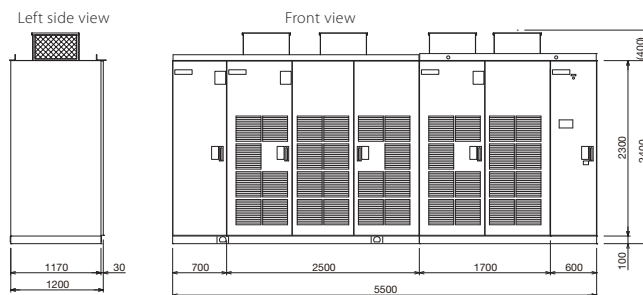

Approx. mass: <660/990/1320kVA> 7800kg  
<2000/2640kVA> 8000 kg

(Unit: mm)

11 kV-3080/3630/4290/5000 kVA

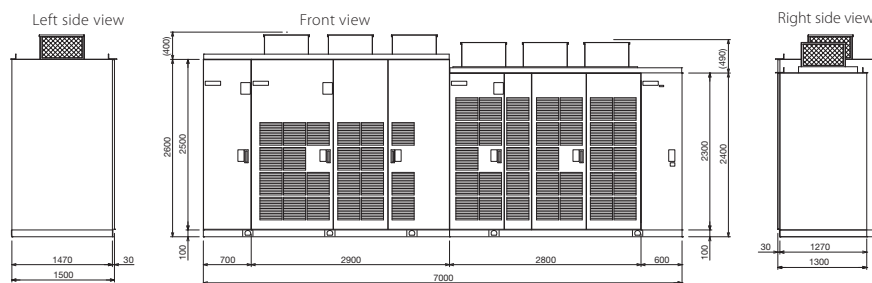

Approx. mass: <3080/3630kVA> 13350 kg  
<4290/5000kVA> 13500 kg

(Unit: mm)

# Global Partner. Local Friend.

## European Offices

<b>Mitsubishi Electric Europe B.V.</b> Mitsubishi-Electric-Platz 1 D-40882 Ratingen Phone: +49 (0)2102 / 486-0	<b>Germany</b>	<b>Mitsubishi Electric (Russia) LLC</b> 52, bld. 1, Kommodamanskaya emb. RU-115054 Moscow Phone: +7 495 / 721 2070	<b>Russia</b>
<b>Mitsubishi Electric Europe B.V.</b> Radická 751/113e Avenir Business Park CZ-158 00 Praha 5 Phone: +420 251 551 470	<b>Czech Rep.</b>	<b>Mitsubishi Electric Europe B.V.</b> Carretera de Rubí 76-80 Apdo. 420 E-08190 Sant Cugat del Valles (Barcelona) Phone: +34 (0) 93 / 5653131	<b>Spain</b>
<b>Mitsubishi Electric Europe B.V.</b> 25, Boulevard des Bouvets F-92741 Nanterre Cedex Phone: +33 (0)1 / 55 68 55 68	<b>France</b>	<b>Mitsubishi Electric Europe B.V. (Scandinavia)</b> Sweden Fjellvägen 8 SE-22736 Lund Phone: +46 (0) 8 625 10 00	<b>Sweden</b>
<b>Mitsubishi Electric Europe B.V.</b> Viale Colonna 7 Palazzo Sirio I-20864 Agrate Brianza (MB) Phone: +39 039 / 60 53 1	<b>Italy</b>	<b>Mitsubishi Electric Turkey Elektrik Ürünleri A.Ş.</b> Turkey Sarıfali Mahallesi Nispeti Sokak No:5 TR-34775 Ümraniye-İSTANBUL Phone: +90 (0)216 / 526 39 90	<b>Turkey</b>
<b>Mitsubishi Electric Europe B.V.</b> Westgate Business Park, Ballymount IRE-Dublin 24 Phone: +353 (0)1 4198800	<b>Ireland</b>	<b>Mitsubishi Electric Europe B.V.</b> Travellers Lane UK-Hatfield, Herts. AL10 8XB Phone: +44 (0)1707 / 28 87 80	<b>UK</b>
<b>Mitsubishi Electric Europe B.V.</b> Nijenheidsweg 23a NL-3641RP Mijdrecht Phone: +31 (0) 297230350	<b>Netherlands</b>	<b>Mitsubishi Electric Europe B.V.</b> Dubai Silicon Oasis United Arab Emirates - Dubai Phone: +971 4 3724716	<b>UAE</b>
<b>Mitsubishi Electric Europe B.V.</b> ul. Krakowska 50 PL-32-083 Balice Phone: +48 (0) 12 347 65 00	<b>Poland</b>		

## Representatives

<b>GEVA</b> Wiener Straße 89 A-2500 Baden Phone: +43 (0)2252 / 85 55 20	<b>Austria</b>	<b>AutoCont C.S. S.R.O.</b> Koflana 1853/3 CZ-702 00 Ostrava 2 Phone: +420 595 69 1 150	<b>Czech Republic</b>	<b>INTEHSIS SRL</b> bld. Teian 23/1 MD-2060 Kishinev Phone: +373 (0)22 / 66 4242	<b>Moldova</b>	<b>INEA FBT d.o.o.</b> Srepske 11 SI-1000 Ljubljana Phone: +386 (0)1 / 513 8116	<b>Slovenia</b>	<b>CEG LIBAN</b> Cebaco Center/Block A Autostrade DORA Lebanon-Beirut Phone: +961 (0)1 / 240 445	<b>Lebanon</b>
<b>OOO TECHNICON</b> Prospect Nezavisimosti 177-9 BY-220125 Minsk Phone: +375 (0)17 / 393 1177	<b>Belarus</b>	<b>HANS FØLSGAARD A/S</b> Theilgaard Torv 1 DK-4600 Køge Phone: +45 4320 8600	<b>Denmark</b>	<b>HIFLEX AUTOM. B.V.</b> Wolvenstraat 22 NL-2984 CD Ridderkerk Phone: +31 (0)180 / 46 60 04	<b>Netherlands</b>	<b>OMNI RAY AG</b> Im Schörl 5 CH-8600 Dübendorf Phone: +41 (0)44 / 802 28 80	<b>Switzerland</b>	<b>ADROIT TECHNOLOGIES</b> South Africa 20 Waterford Office Park 189 Witkoppen Road ZA-Fourways Phone: +27 (0)11 / 658 8100	
<b>ESCO DRIVES</b> Culliganlaan 3 BE-1831 Diegem Phone: +32 (0)2 / 717 64 60	<b>Belgium</b>	<b>PROVENDOR OY</b> Teljankatu 8 A3 FIN-28130 Porii Phone: +358 (0) 2 / 522 3300	<b>Finland</b>	<b>KONING &amp; HARTMAN B.V.</b> Energieweg 1 NL-2627 AP Delft Phone: +31 (0)15 260 99 06	<b>Netherlands</b>	<b>OOO "CSC-AUTOMATION"</b> Ukraine 4-B, M. Raszkovyi St. UA-02660 Kiev Phone: +380 (0)44 / 494 33 44	<b>Ukraine</b>		
<b>KONING &amp; HARTMAN B.V.</b> Wolvenlaan 31 BE-1800 Vilvoorde Phone: +32 (0)2 / 257 02 40	<b>Belgium</b>	<b>UTECO A.B.E.E.</b> 5, Marmarones St. GR-18542 Piraeus Phone: +30 (0)211 / 1206-900	<b>Greece</b>	<b>Fonseca S.A.</b> R. João Francisco do Casal 87/89 PT-3801-997 Aveiro, Espueira Phone: +351 (0)234 / 303 900	<b>Portugal</b>	<b>ILAN &amp; GAVISH Ltd.</b> 24 Shenkar St., Kiryat Arze IL-49001 Petah-Tikva Phone: +972 (0)3 / 922 18 24	<b>Israel</b>		
<b>INEA RBT d.o.o.</b> Bosnia and Herzegovina Stepne 11 SI-1000 Ljubljana Phone: +386 (0)1 / 513 8116	<b>Bosnia and Herzegovina</b>	<b>MELTRADE Kft.</b> Fertő utca 14. HU-1107 Budapest Phone: +36 (0)1 / 431-9726	<b>Hungary</b>	<b>Sirius Trading &amp; Services</b> Aleea Lacul Morii Nr. 3 RO-060841 Bucuresti, Sector 6 Phone: +40 (0)21 / 430 40 06	<b>Romania</b>	<b>GIRIT CELADON Ltd.</b> 12 Haomanut Street IL-42505 Netanya Phone: +972 (0)9 / 863 39 80	<b>Israel</b>		
<b>AKHNATON</b> 4, Andrei Lapchev Blvd., PO Box 21 BG-1756 Sofia Phone: +359 (0)2 / 817 6000	<b>Bulgaria</b>	<b>TDO Kazpromatomatika</b> Ul. Zhambyla 28 KAZ-100017 Karaganda Phone: +7 712 / 30 10 00	<b>Kazakhstan</b>	<b>INEA SR d.o.o.</b> Ul. Karadjordjeva 12/217 SER-11300 Smederevo Phone: +386 (0)26 461 54 01	<b>Serbia</b>	<b>SHERF MOTION TECHN. Ltd.</b> Rethov Hamekava 19 IL-58851 Holon Phone: +972 (0)3 / 559 54 62	<b>Israel</b>		
<b>INEA CR</b> Lazovska 4 HR-10000 Zagreb Phone: +385 (0)1 / 36 940- 01/-02/-03	<b>Croatia</b>	<b>ALFATRADE Ltd.</b> 99, Paola Hill Malta-Paola PLA 1702 Phone: +356 (0)21 / 697 816	<b>Malta</b>	<b>SIMAP SK</b> Jana Nerfa 1671 SK-911 01 Trenčín Phone: +421 (0)32.743.04.72	<b>Slovakia</b>				

## Version check



## Mitsubishi Electric Europe B.V.

FA - European Business Group  
Mitsubishi-Electric-Platz 1  
D-40882 Ratingen Germany  
Tel.: +49(0)2102-4860 Fax: +49(0)2102-4861120  
info@mitsubishi-automation.com  
https://eu3a.mitsubishielectric.com