

# **mitsubishi**

## **Mitsubishi Industrial Robot**

**CRn-500 Series**

**Network Vision Sensor Instruction Manual**

---

**3D-51C-WINE**

**4D-2CG5100-PKG-E**

**4D-2CG5400-PKG-E**

**4D-2CG5401-PKG-E**

**4D-2CG5403-PKG-E**

**4D-2CG5400C-PKG-E**

**4D-2CG5400R-PKG-E**

**MELFA**  
**BFP-A8520-A**





■ Revision History

Printing Date	Instruction Manual No.	Revision Contents
2009-09-18	BFP-A8520	First Edition
2009-10-08	BFP-A8520-A	Correspond to MELFA-Vision Ver.1.1.1 and 1.2. •The lineup added. (High performance / high speed / Micro)



## ■ Preface

Thank you for purchasing this network vision sensor for CRn-500 series Mitsubishi Electric industrial robots. The network vision sensor is an option that is used in combination with a CRn-500 series controller to make it possible to detect and inspect work through visual recognition. Before using this sensor, please read this manual well so that you utilize the contents of this manual when using this network vision sensor. This manual attempts to cover special handling as well. Please interpret the absence of an operation from this manual as meaning that it can not be done.

The contents of this manual target the following software versions.

Robot controller : Ver. K6 or later

## ■ Symbols & Notation Method in This Manual









- |  |                       |  |
|--|-----------------------|--|
|   | <b><i>DANGER</i></b>  | This indicates a situation in which a mistake in handling will expose the user to the danger of death or severe injury.                    |
|   | <b><i>WARNING</i></b> | This indicates a situation in which a mistake in handling has the possibility of resulting in death or severe injury of the user.          |
|  | <b><i>CAUTION</i></b> | This indicates a situation in which a mistake in handling has the danger of causing injury to the user. Equipment damage is also possible. |

- No part of this manual may be reproduced by any means or in any form, without prior consent from Mitsubishi.
- The details of this manual are subject to change without notice.
- An effort has been made to make full descriptions in this manual. However, if any discrepancies or unclear points are found, please contact your dealer.
- The information contained in this document has been written to be accurate as much as possible. Please interpret that items not described in this document “cannot be performed.”. Please contact your nearest dealer if you find any doubtful, wrong or skipped point.
- Microsoft, Windows, and .NET Framework are registered trademarks of the Microsoft Corporation of the United States in the United States and/or other countries.
- In-Sight is registered trademark of the Cognex Corporation.
- Adobe, the Adobe logo, Acrobat, and the Acrobat logo are trademarks of Adobe Systems incorporated.
- Reference to registered trademarks and trademarks are omitted in this manual.

Copyright(C) 2006-2009 MITSUBISHI ELECTRIC CORPORATION ALL RIGHTS RESERVED

## Safety Precautions

Always read the following precautions and the separate "Safety Manual" before starting use of the robot to learn the required measures to be taken.

-  CAUTION** All teaching work must be carried out by an operator who has received special training. (This also applies to maintenance work with the power source turned ON.)  
Enforcement of safety training
-  CAUTION** For teaching work, prepare a work plan related to the methods and procedures of operating the robot, and to the measures to be taken when an error occurs or when restarting. Carry out work following this plan. (This also applies to maintenance work with the power source turned ON.)  
Preparation of work plan
-  WARNING** Prepare a device that allows operation to be stopped immediately during teaching work. (This also applies to maintenance work with the power source turned ON.)  
Setting of emergency stop switch
-  CAUTION** During teaching work, place a sign indicating that teaching work is in progress on the start switch, etc. (This also applies to maintenance work with the power source turned ON.)  
Indication of teaching work in progress
-  WARNING** Provide a fence or enclosure during operation to prevent contact of the operator and robot.  
Installation of safety fence
-  CAUTION** Establish a set signaling method to the related operators for starting work, and follow this method.  
Signaling of operation start
-  CAUTION** As a principle turn the power OFF during maintenance work. Place a sign indicating that maintenance work is in progress on the start switch, etc.  
Indication of maintenance work in progress
-  CAUTION** Before starting work, inspect the robot, emergency stop switch and other related devices, etc., and confirm that there are no errors.  
Inspection before starting work

The points of the precautions given in the separate "Safety Manual" are given below.  
Refer to the actual "Safety Manual" for details.

**⚠WARNING** When automatically operating the robot with multiple control devices (GOT, PLC, pushbutton switch), the interlocks, such as each device's operation rights must be designed by the user.

**⚠CAUTION** Use the robot within the environment given in the specifications. Failure to do so could lead to a drop or reliability or faults. (Temperature, humidity, atmosphere, noise environment, etc.)

**⚠CAUTION** Transport the robot with the designated transportation posture. Transporting the robot in a non-designated posture could lead to personal injuries or faults from dropping.

**⚠CAUTION** Always use the robot installed on a secure table. Use in an instable posture could lead to positional deviation and vibration.

**⚠CAUTION** Wire the cable as far away from noise sources as possible. If placed near a noise source, positional deviation or malfunction could occur.

**⚠CAUTION** Do not apply excessive force on the connector or excessively bend the cable. Failure to observe this could lead to contact defects or wire breakage.

**⚠CAUTION** Make sure that the workpiece weight, including the hand, does not exceed the rated load or tolerable torque. Exceeding these values could lead to alarms or faults.

**⚠WARNING** Securely install the hand and tool, and securely grasp the workpiece. Failure to observe this could lead to personal injuries or damage if the object comes off or flies off during operation.

**⚠WARNING** Securely ground the robot and controller. Failure to observe this could lead to malfunctioning by noise or to electric shock accidents.

**⚠CAUTION** Indicate the operation state during robot operation. Failure to indicate the state could lead to operators approaching the robot or to incorrect operation.

**⚠WARNING** When carrying out teaching work in the robot's movement range, always secure the priority right for the robot control. Failure to observe this could lead to personal injuries or damage if the robot is started with external commands.

**⚠CAUTION** Keep the jog speed as low as possible, and always watch the robot. Failure to do so could lead to interference with the workpiece or peripheral devices.

**⚠CAUTION** After editing the program, always confirm the operation with step operation before starting automatic operation. Failure to do so could lead to interference with peripheral devices because of programming mistakes, etc.

**⚠CAUTION** Make sure that if the safety fence entrance door is opened during automatic operation, the door is locked or that the robot will automatically stop. Failure to do so could lead to personal injuries.

**⚠CAUTION** Never carry out modifications based on personal judgments, or use non-designated maintenance parts.  
Failure to observe this could lead to faults or failures.

**⚠WARNING** When the robot arm has to be moved by hand from an external area, do not place hands or fingers in the openings. Failure to observe this could lead to hands or fingers catching depending on the posture.

## ⚠CAUTION

Do not stop the robot or apply emergency stop by turning the robot controller's main power OFF. If the robot controller main power is turned OFF during automatic operation, the robot accuracy could be adversely affected. Moreover, it may interfere with the peripheral device by drop or move by inertia of the arm.

## ⚠CAUTION

Do not turn off the main power to the robot controller while rewriting the internal information of the robot controller such as the program or parameters. If the main power to the robot controller is turned off while in automatic operation or rewriting the program or parameters, the internal information of the robot controller may be damaged.

Precautions for the basic configuration are shown below. (When CR1-571/CR1B-571 is used for the controller.)

## ⚠CAUTION

Provide an earth leakage breaker that packed together on the primary power supply of the controller as protection against electric leakage. Confirm the setting connector of the input power supply voltage of the controller, if the type which more than one power supply voltage can be used. Then connect the power supply. Failure to do so could lead to electric shock accidents.

Power supply \*RV-1A/2AJ series and RP-1AH/3AH/5AH series: Single phase 90-132VAC, 180-253VAC.  
\*Except the above: Single phase 180-253VAC.

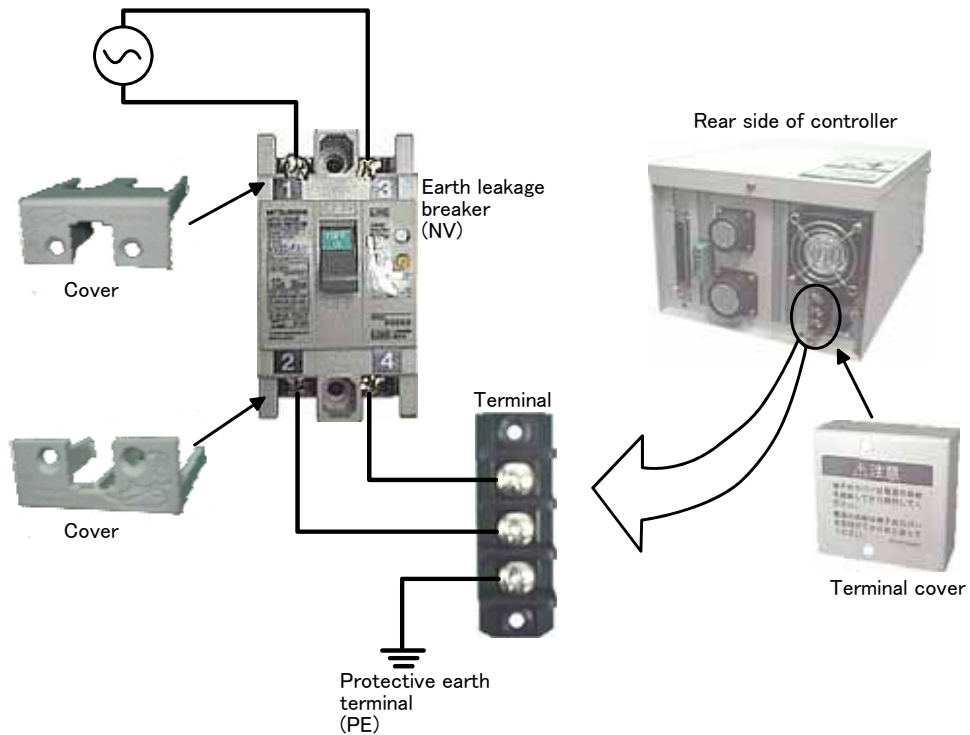

## ⚠WARNING

For using RH-5AH/10AH/15AH series or RH-6SH/12SH/18SH series. While pressing the brake releasing switch on the robot arm, beware of the arm which may drop with its own weight. Dropping of the hand could lead to a collision with the peripheral equipment or catch the hands or fingers.



# Contents

<b>1. SUMMARY .....</b>	<b>1-1</b>
1.1. <b>What A Network Vision Sensor Is.....</b>	<b>1-1</b>
1.2. <b>Features .....</b>	<b>1-2</b>
1.3. <b>Applications.....</b>	<b>1-3</b>
1.4. <b>Explanation of terms .....</b>	<b>1-5</b>
<b>2. SYSTEM CONFIGURATION.....</b>	<b>2-6</b>
2.1. <b>Component Devices .....</b>	<b>2-6</b>
2.1.1. Network vision sensor basic set composition and accessories .....	2-6
2.1.2. Equipment provided by customer .....	2-10
2.2. <b>System configuration example.....</b>	<b>2-11</b>
2.2.1. Configuration with one robot controller (for CR1 controller) and one vision sensor .....	2-11
2.2.2. Configuration with one robot controller and two vision sensors .....	2-12
2.2.3. Configuration with three robot controllers and one vision sensor .....	2-13
<b>3. SPECIFICATIONS.....</b>	<b>3-14</b>
3.1. <b>Network vision sensor specifications.....</b>	<b>3-14</b>
3.1.1. External Dimensions of Network Vision Sensor(5100/5400/5401/5403/5400C) .....	3-15
3.1.2. External Dimensions of Network Vision Sensor 5400R.....	3-16
3.2. <b>Robot controller specifications .....</b>	<b>3-18</b>
3.3. <b>MELFA-Vision .....</b>	<b>3-19</b>
3.3.1. Features.....	3-19
3.3.2. Operating Environment .....	3-20
<b>4. WORK CHARTS .....</b>	<b>4-21</b>
4.1. <b>Work procedure chart .....</b>	<b>4-21</b>
<b>5. EQUIPMENT PREPARATION AND CONNECTION .....</b>	<b>5-22</b>
5.1. <b>Equipment preparation.....</b>	<b>5-22</b>
5.2. <b>Equipment connection .....</b>	<b>5-23</b>
5.2.1. Expansion option box installation (for CR1 controller).....	5-23
5.2.2. Mounting the Ethernet interface card (card name: HR533).....	5-23
5.2.3. Individual equipment connections.....	5-23
5.3. <b>Software installation.....</b>	<b>5-25</b>
5.3.1. Vision sensor dedicated software (In-Sight Explorer before Ver.4.1) installation .....	5-25

5.3.2.	Vision sensor dedicated software (In-Sight Explorer Ver.4.1 or later) installation .....	5-26
5.3.3.	MELFA-Vision installation .....	5-27
<b>6.</b>	<b>VISION SENSOR SETTINGS .....</b>	<b>6-29</b>
6.1.	<b>Vision Sensor Initial Settings .....</b>	<b>6-29</b>
6.2.	<b>Vision Sensor Initial Settings (In-Sight Explorer Ver.4.1 or later) .....</b>	<b>6-32</b>
6.3.	<b>Work recognition test .....</b>	<b>6-34</b>
6.3.1.	Starting MELFA-Vision (network vision sensor support software) .....	6-34
6.3.2.	Image adjustment.....	6-39
6.3.3.	Image processing settings .....	6-42
<b>7.</b>	<b>ROBOT CONTROLLER SETTINGS.....</b>	<b>7-57</b>
7.1.	<b>Robot Controller Parameter Settings.....</b>	<b>7-57</b>
7.2.	<b>Calibration Setting.....</b>	<b>7-62</b>
7.3.	<b>Robot Program Writing .....</b>	<b>7-73</b>
7.3.1.	Flow for starting of image processing by robot .....	7-73
7.3.2.	Writing a Sample Robot Program .....	7-73
7.4.	<b>Executing the automatic operation test.....</b>	<b>7-75</b>
7.4.1.	Put the vision sensor online .....	7-75
7.4.2.	Test by executing each step.....	7-75
7.4.3.	Starting a Robot Program.....	7-76
7.5.	<b>When the robot can not grasp the work normally.....</b>	<b>7-78</b>
7.5.1.	Check the MELFA-Vision [Camera Image] .....	7-78
7.5.2.	Comparison of the position data for the work recognized by the vision sensor and the position data received by the robot.....	7-78
<b>8.</b>	<b>MAINTENANCE .....</b>	<b>8-80</b>
8.1.	<b>Vision Sensor Data Backup .....</b>	<b>8-80</b>
8.2.	<b>Vision Sensor Data Restoration .....</b>	<b>8-82</b>
8.3.	<b>Vision Sensor Cloning .....</b>	<b>8-85</b>
8.4.	<b>Image Log Acquisition Settings and Reception Start/End .....</b>	<b>8-87</b>
8.5.	<b>Vision Startup Settings .....</b>	<b>8-88</b>
8.6.	<b>User List Settings .....</b>	<b>8-89</b>
<b>9.</b>	<b>DETAILED EXPLANATION OF FUNCTIONS .....</b>	<b>9-91</b>
9.1.	<b>Vision Sensor Dedicated Commands and Status Variables.....</b>	<b>9-91</b>
9.1.1.	How to Read Items.....	9-91
9.1.2.	MELFA-BASIC IV Commands .....	9-91
9.1.3.	Robot status variables.....	9-107
9.2.	<b>MELFA-Vision Function Details .....</b>	<b>9-115</b>
9.2.1.	MELFA-Vision Main Screen .....	9-115

9. 2. 2.	Job Editing screen ([Image Log] tab).....	9-116
9. 2. 3.	Job edit screen ([Result Cell Position] tab).....	9-117
9. 2. 4.	Vision sensor network settings .....	9-118
<b>9. 3.</b>	<b>Vision program detailed explanation .....</b>	<b>9-119</b>
9. 3. 1.	Templates provided for MELFA-Vision.....	9-119
9. 3. 2.	Image processing - blobs.....	9-121
9. 3. 3.	Image processing – Color .....	9-124
9. 3. 4.	Using image processing for which there is no template .....	9-132
9. 3. 5.	To shorten the time for transferring data with the robot controller .....	9-133
<b>9. 4.</b>	<b>Detailed explanation of systems combining multiple vision sensors and robots.....</b>	<b>9-136</b>
9. 4. 1.	Systems with one robot controller and multiple vision sensors .....	9-136
9. 4. 2.	Systems with one vision sensor and multiple robot controllers .....	9-137
<b>10.</b>	<b>TROUBLESHOOTING .....</b>	<b>10-139</b>
10. 1.	Error list .....	10-139
<b>11.</b>	<b>APPENDIX.....</b>	<b>11-142</b>
11. 1.	<b>Performance of this product (comparison with built-in type RZ511 vision sensor) .....</b>	<b>11-142</b>
11. 1. 1.	Comparison of work recognition rate .....	11-142
11. 1. 2.	Comparison of image processing capacity .....	11-142
11. 1. 3.	Factors affecting the processing time .....	11-143
11. 2.	<b>Calibration No. marking sheet.....</b>	<b>11-144</b>

# 1. Summary

## 1. 1. What A Network Vision Sensor Is

The network vision sensor is an option that makes it possible to discriminate the position of various types of work and transport, process, assemble, inspect, and measure work with MELFA robots. It consists of MELFA-Vision and the vision sensor, and the related options.

## 1. 2. Features

The network vision sensor has the following functions.

### (1) Position detection through high-speed image processing

• High-speed image processing makes it possible to detect the work at high speed, not only when the angle is not detected, but even when the work includes 360° rotation.

① When the angle is not detected : about 50 ms

② When detecting 360° : about 150 ms

\* Measurement conditions Search area: 640x480, Pattern: 90x90

This is the pattern matching processing time using In-Sight5400 (camera exposure time of 8 ms)

\* These values are reference values. These values are not guaranteed.

### (2) Ethernet communication

• Since the system can be configured with an Ethernet network, a wide variety of system configurations can be realized.

① Up to seven vision sensors can be controlled with one robot controller.

② Up to three robot controllers can share control of one vision sensor.

③ Systems can be configured with multiple robot controllers and multiple vision sensors.

④ Both robot controller and vision sensor can be debugged using one PC.

• "MELFA-Vision Network Vision Support Software" has image log functions, so it is possible to check the image state when an error occurred.

### (3) Easy setting

• Connect a vision sensor by just connecting the Ethernet cable and the power supply cable. At the robot controller, just connect the Ethernet cable to the Ethernet interface card.

• The vision sensor and robot controller settings can be made simply with MELFA-Vision.

### (4) Easy robot program calibration

• The program can be made easily with MELFA-BASIC IV commands available for vision sensor exclusively.

① "NVOPEN" command that connects the robot and vision sensor line

② "NVPST" command that starts the vision program and obtains the results

③ "NVCLOSE" command that cuts off the robot and vision sensor line

• This system is equipped with a simple calibration function that can handle a variety of camera installation positions.

### (5) Space saving, wiring saving

• Since the vision sensor combines the camera and controller in one piece, the only wiring needed is the Ethernet cable and power supply cable, so wiring does not take up space.

### (6) Easy maintenance

• It is possible to store recognized images on a PC with MELFA-Vision running, to check the image when an error occurred, and to find the cause of the error easily.

## 1. 3. Applications

Here are major applications of the network vision sensor.

### (1) Loading/Unloading Machined Parts

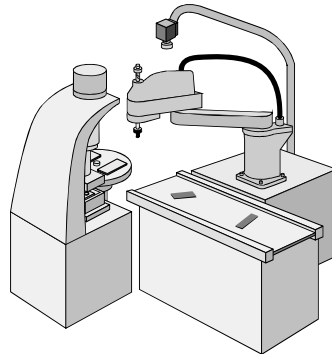

Figure 1-1 Example of Loading/Unloading Machined Parts

### (2) Processed Food Pallet Transfer

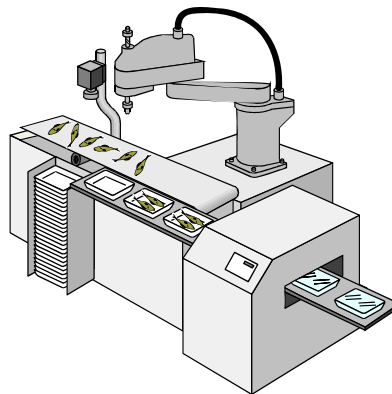

Figure 1-2 Example of Processed Food Pallet Transfer

### (3) Lining Up and Palletizing Electronic Parts

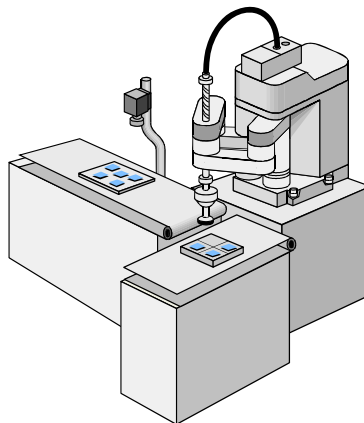
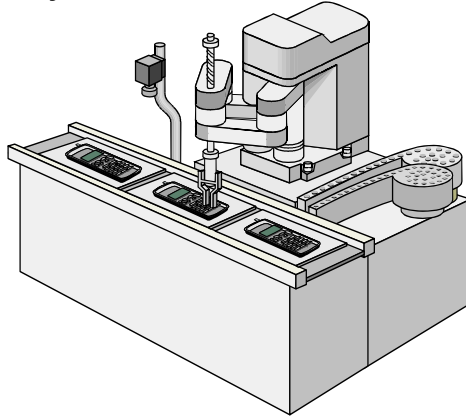

Figure 1-3 Example of Lining Up and Palletizing Electronic Parts

**(4) Small Electrical Product Assembly**



**Figure 1-4 Example of Small Electrical Product Assembly**

**(5) Lining Up Parts**

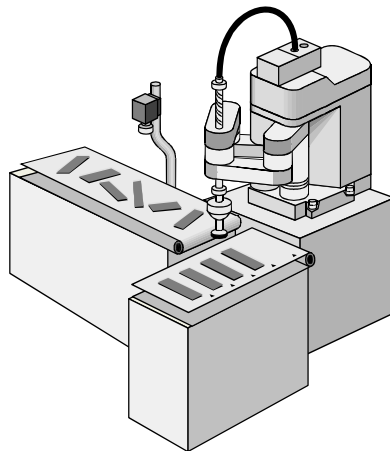

**Figure 1-5 Example of Lining Up Parts**

**(6) Small Electronic Parts Mounting**

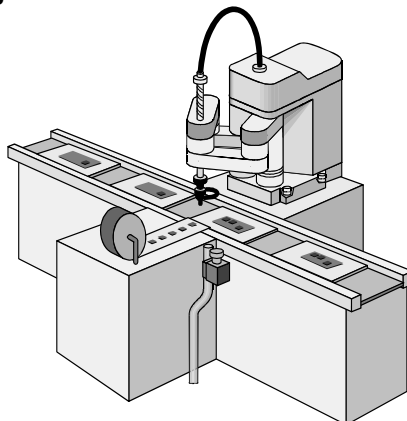

**Figure 1-6 Example of Small Electronic Parts Mounting**

## 1. 4. Explanation of terms

This section explains the terms used in this manual.

- CCD (Charge Coupled Device) · This is the most general pickup element used in cameras.
- Degree of matching (score) ····· This value indicates the degree to which the image matches the registered pattern. This value ranges from 0 to 100. The closer to 100, the higher the degree of matching.
- Offline ····· This is a vision sensor mode for such work as setting the vision sensor operating environment, setting the image processing, and backing up data to a PC.
- Online ····· This is the vision sensor mode in which the vision sensor executes image processing under command from the robot controller.
- Picture element (pixel) ····· This is the smallest unit of data making up the image. One image comprises 640x480 pixels. Depending on the type of vision sensor, one image comprises 1024x768 or 1600x1200 pixels.
- Contrast ····· This is a yardstick expressing the "brightness" of a pixel in units from 0-255. The smaller this value, the darker the pixel; the higher this value, the brighter the pixel.
- Calibration ····· This is coordinate conversion for converting from the image processing coordinate system to the robot coordinate system.
- Threshold ····· This is the cutoff point for degree of matching scores.
- Shutter speed ····· This is the exposure time (the time during which the CCD accumulates charge).
- Sort ····· This rearranges the order in which data (recognition results) is output to the robot according to the specified item.
- Trigger ····· This is the starting signal for starting the exposure (image capture).
- Pattern matching ····· This is processing for detecting the pattern that matches the pattern registered from the captured image.
- Vision program (job) ····· This is the program that executes such image processing as pattern matching, blobbing, etc. The image processing can be set freely.
- Filter ····· This is a form of image processing for improving the picture quality.
- Blob ····· This is a type of image processing for detecting blobs with features in the image captured. Bright sections are expressed as white; dark sections are expressed as black.
- Host name ····· This is the network vision sensor name. This is registered in the initial settings.
- Live ····· Images can be displayed in real time by shooting continuously.
- Area ····· This is the processing area for executing image processing.
- Log function ····· This function stores the image taken in with online operation and the execution results (log).
- Exposure ····· This is the accumulation of charge on the CCD. When light strikes the CCD, charge accumulates and the degree of this accumulation becomes the degree of brightness of the image.



## 2. System configuration

### 2.1. Component Devices

#### 2.1.1. Network vision sensor basic set composition and accessories

The composition of the network vision sensor basic set that you have purchased is shown in "Table 2-1 List of Network Vision Sensor Basic Set Composition".

Table 2-1 List of Network Vision Sensor Basic Set Composition

Composition article name Type	Network vision sensor set						MELFA-Vision
	4D-2CG 5100 -PKG	4D-2CG 5400 -PKG	4D-2CG 5401 -PKG	4D-2CG 5403 -PKG	4D-2CG 5400C -PKG	4D-2CG 5400R -PKG	3D-51C -WINE
Vision sensor 5100	●						Prepare by the customer (*5) (*6)
Vision sensor 5400		●					
Vision sensor 5401			●				
Vision sensor 5403				●			
Vision sensor 5400C					●		
Vision sensor 5400R						●	
Lens cover—			●				Prepare by the customer (*5)
Thread guard			●				
Breakout cable (5m) (*1)				●			
Network cable (5m) (*1)				●			
Camera cable (5m) (*4)						●	
remote head camera installation bracket (*4)						●	
In-Sight5000 series installation guide			●				
CD-ROM :Part# 206-6364-*** (*2) •In-Sight Explorer •In-Sight Display Control •In-Sight OPC Server Software Document (Help/Installation Manuals)				●			
<b>MELFA-Vision :</b> CD-ROM :3D-51C-WINE (*3) •MELFA-Vision (Network vision support software) •Instruction manual . BFP-A8779				●		●	

- (\*1) The cable length can be changed. For details, see "Table 2-2 List of Network Vision Sensor Related Options".
- (\*2) This is a CD-ROM that comes with a vision sensor made by the Cognex Corporation. This CD-ROM contains the software and operations manual required for using the network vision sensor.  
The \*\*\* in the model name part number is the version number.
- (\*3) MELFA-Vision and the instruction manual are included.
- (\*4) The camera cable which connects the remote head camera and the vision sensor, and the remote head camera installation bracket is bundled for Network Vision sensor 5400R.
- (\*5) These specifications apply when the vision sensor and related options are prepared by the user and only MELFA-Vision (network vision sensor support software and instruction manual) is provided. The applicable vision sensors (COGNEX brand) are listed in Table 3-4 THE CORRESPONDENCE TYPE AND VERSION OF MELFA-VISION for reference.
- (\*6) Note: The vision sensor must be equipped with an image processing algorithm (PatMax).

Table 2-2 List of Network Vision Sensor Related Options

Option name		Model
Ethernet interface card		2A-HR533
Expansion option box		CR1-EB3
Network cable	0.6m	CCB-84901-1001-00
	2m	CCB-84901-1002-02
	5m	CCB-84901-1003-05
	10m	CCB-84901-1004-10
	15m	CCB-84901-1005-15
	30m	CCB-84901-1006-30
Breakout cable	2m	CCB-84901-0101-02
	5m	CCB-84901-0102-05
	10m	CCB-84901-0103-10
	15m	CCB-84901-0104-15
Camera cable	5m	CCB-84901-0303-05
	10m	CCB-84901-0304-10
	15m	CCB-84901-0305-15
I/O Module	Terminal block conversion module	CIO-1350
	I/O Expansion module (8 inputs/8 outputs)	CIO-1450
Diffused ring light(red)		IFS-DRL-050
Direct ring light(red)		IFS-RRL050
Direct ring light(white)		IFS-WRL050
Network vision sensor instruction manual (booklet)		BFP-A8779

The composition of the basic set(All-in-one design) are shown in figures.

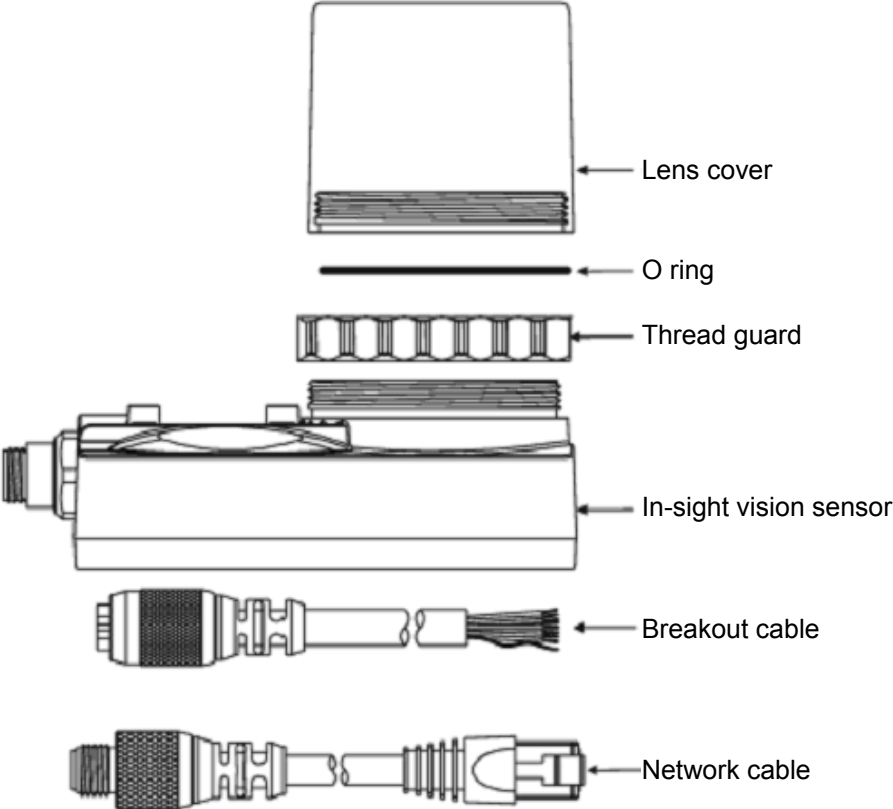

Installation guide

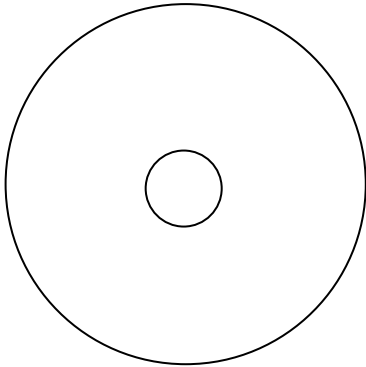

In-Sight Software CD-ROM



MELFA-Vision CD-ROM

Figure 2-1 Basic set(All-in-one design) composition

## 2 System configuration

The composition of 4D-2CG-5400R-PKG(Remote Head) are shown in figures.

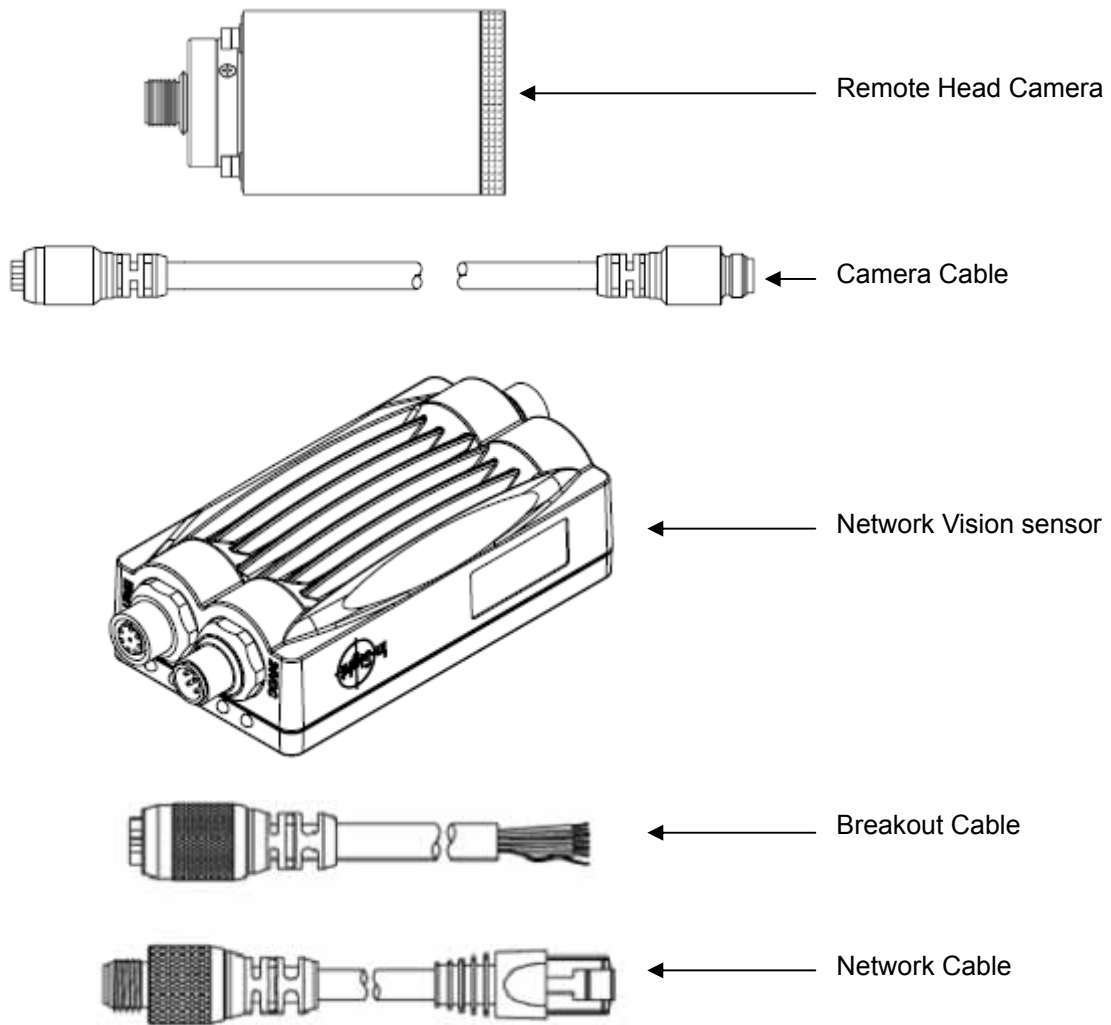

Installation guide

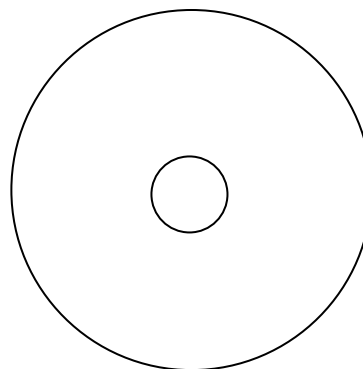

In-Sight Software CD-ROM



MELFA-Vision CD-ROM

Figure 2-2 Basic set(Remote Head Type) composition

### 2.1.2. Equipment provided by customer

In addition to this product, the system also includes equipment provided by the customer. "Table 2-3 List of Equipment Provided by Customer" shows the minimum necessary equipment. The equipment for the customer to provide depends on the system. For details, see "2.2 System configuration example".

**Table 2-3 List of Equipment Provided by Customer**

Device name	Recommended product	
Vision sensor	In-Sight5000 series (Refer Table 2-1) (*1)	
Breakout cable	— (Refer Table 2-1, Table 2-2) (*1)	
Network cable	— (Refer Table 2-1, Table 2-2) (*1)	
Camera lens	C mount lens (CS mount lens is possible for 5400R.)	
24V power supply	24 VDC ( $\pm 10\%$ ) (5100/5400/5400C/5401 are 350mA or larger, 5403 is 500mA or larger, 5400R is 250mA or larger.)	
PC	CPU	Intel® Pentium® III 700MHz (or equivalent) or faster
	Memory size	256 MB min.
	Hard disk	Available capacity of 200 MB min.
	OS	Microsoft® Windows® 2000, Service Pack 4 Microsoft® Windows® XP Professional, Service Pack 2
	Display	An SVGA (800x600) or higher resolution display with graphic functions that can display at least 16 colors
	Disc device	CD-ROM drive
	Keyboard	PC/AT compatible keyboard
	Pointing device	Device that operates in Windows® operating system
	Communications	Must have Ethernet line that operates in Windows® operating system
Hub	A switching hub is recommended.	
Ethernet straight cable	Any straight Ethernet cable is OK.	
Lighting device	Select the optimum lighting for the work to be recognized. LED lights are recommended for their long service life.	

(\*1) It is attached to the network vision sensor set

## 2. 2. System configuration example

### 2. 2. 1. Configuration with one robot controller (for CR1 controller) and one vision sensor

Below is shown the entire configuration (robot system) when one camera is used.

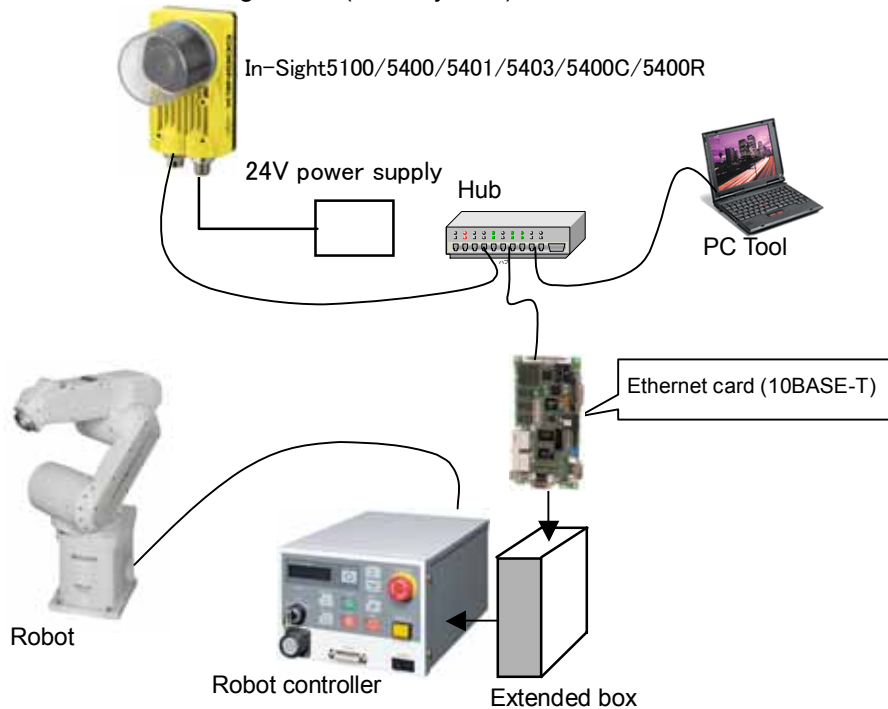

Figure 2-3 Configuration (Robot System) When One Camera Is Used

Below is a list of the equipment configuration when one camera is used.

Table 2-4 List of Configuration When One Camera Is Used

Part name		Format	Manufacturer	Q'ty	Remarks	
Robot controller		CRn-500 series	Mitsubishi Electric	1	Software: <b>K6</b> or later	
Robot main unit		All models		1		
Expansion option box		CR1-EB3		(1)		For CR1 controller
Ethernet interface card		2A-HR533		1		
MELFA-Vision		3D-51C-WINE		1	(* 4)	
Vision sensor	Vision sensor	In-Sight 5000 series	COGNEX	1	Software: <b>3.20</b> or later(* 4)	
	Breakout cable	—		1		(* 4)
	Network cable	—		1		(* 4)
Lens		C mount lens(*1)	—	1	Provided by customer (*2)	
24V power supply		— (*3)	—	1		
PC		—	—	1		
Hub		—	—	1		
Ethernet cable (straight)		—	—	2		
Lighting device		—	—	1		

(\*1) Select from general C mount lenses.

(\*2) The half tone (gray) section is the equipment provided by the customer.

(\*3) For the 24 VDC ( $\pm 10\%$ ) power supply, the vision sensor requires a minimum of 350 mA(5403:a minimum of 500mA / 5400R: a minimum of 250mA).

(\*4) It is attached to the network vision sensor set

## 2.2.2. Configuration with one robot controller and two vision sensors

Below is shown the entire configuration (robot system) when two cameras are used.

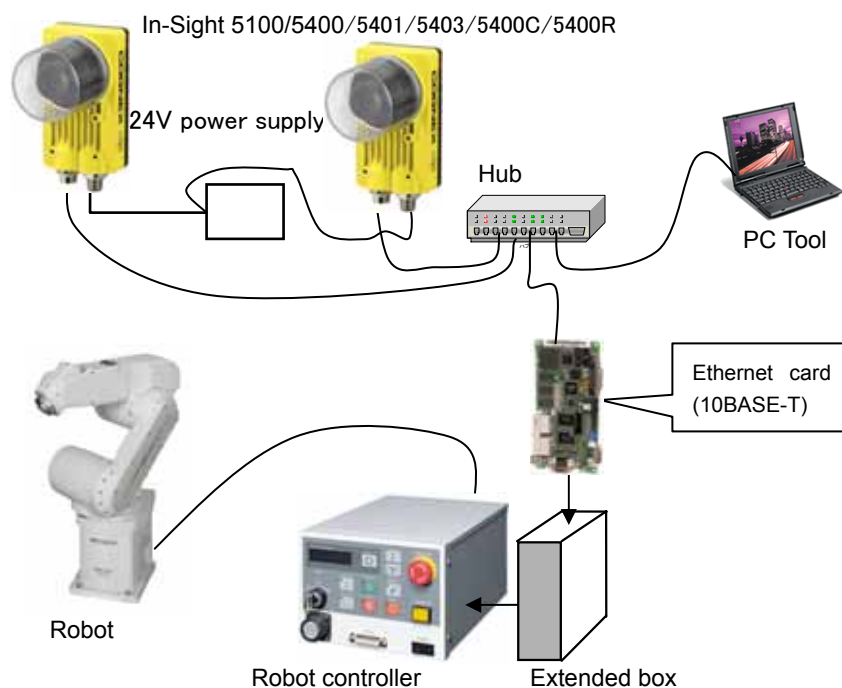

Figure 2-4 Configuration (Robot System) When Two Cameras Are Used

Below is a list of the equipment configuration when two cameras are used.

Table 2-5 List of Configuration When Two Cameras Are Used

Part name		Format	Manufacturer	Q'ty	Remarks
Robot controller		CRn-500 series	Mitsubishi Electric	1	Software: <b>K6</b> or later
Robot main unit		All models		1	
Expansion option box		CR1-EB3		(1)	For CR1 controller
Ethernet interface card		2A-HR533		1	
MELFA-Vision		3D-51C-WINE		1	(* 5)
Vision sensor (*4)	Vision sensor	In-Sight 5000 series	COGNEX	2	Software: <b>3.20</b> or later(* 5)
	Breakout cable	—		2	(* 5)
	Network cable	—		2	(* 5)
Lens (*4)		C mount lens(*1)	—	2	Provided by customer (*2)
24V power supply		— (*3)	—	1	
PC		—	—	1	
Hub		—	—	1	
Ethernet cable (straight)		—	—	2	
Lighting device		—	—	1	

(\*1) Select from general C mount lenses.

(\*2) The half tone (gray) section is the equipment provided by the customer.

(\*3) For the 24 VDC ( $\pm 10\%$ ) power supply, the vision sensor requires a minimum of 350 mA(5403:a minimum of 500mA / 5400R: a minimum of 250mA).

(\*4) Up to seven vision sensors can be connected at the same time to one robot controller, so prepare the "necessary quantity" for the number of vision sensors you use.

(\*5) It is attached to the network vision sensor set

2.2.3. Configuration with three robot controllers and one vision sensor

Below is shown the entire configuration (robot system) when one camera is used with three robots.

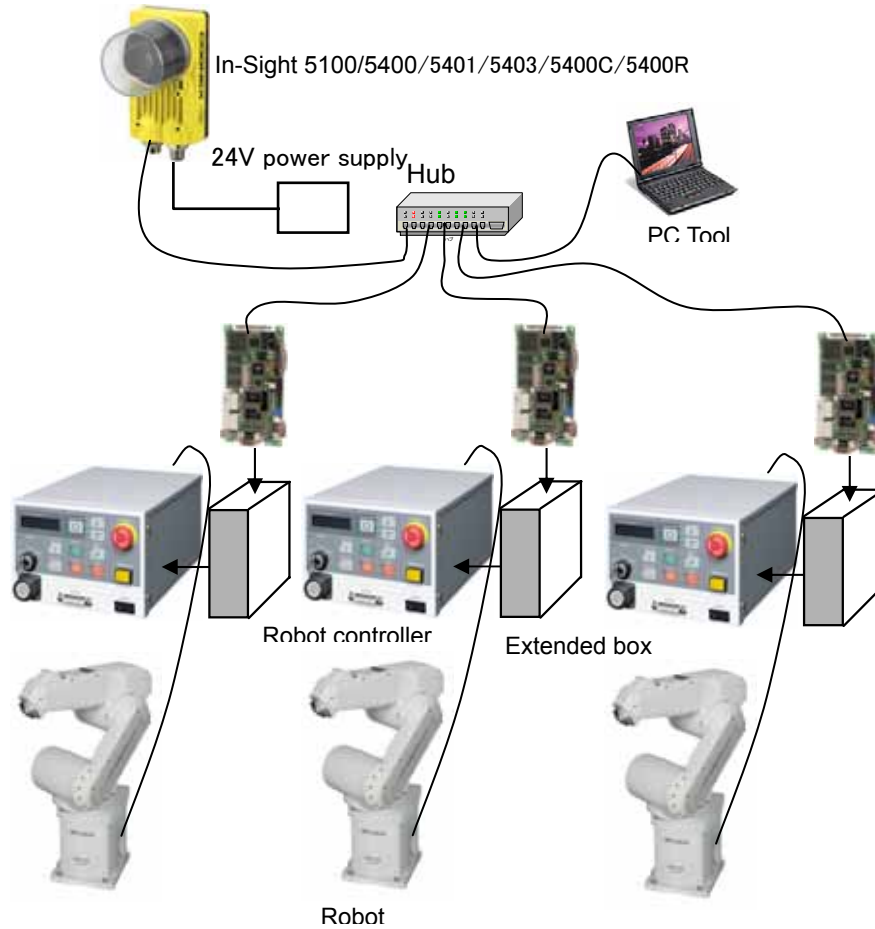

Figure 2-5 Configuration (Robot System) When One Camera Is Used with Three Robots

Below is a list of the equipment configuration when one camera is used with three robots.

Table 2-6 List of Configuration When One Camera Is Used with Three Robots

Part name		Format	Manufacturer	Q'ty	Remarks	
Robot controller (*4)		CRn-500 series	Mitsubishi Electric	1	Software: <b>K6</b> or later	
Robot main unit		All models		3		
Expansion option box		CR1-EB3		(3)		For CR1 controller
Ethernet interface card		2A-HR533		3		
MELFA-Vision		3D-51C-WINE		1	(* 5)	
Vision sensor	Vision sensor	In-Sight 5000 series	COGNEX	1	Software: <b>3.20</b> or later (* 5)	
	Breakout cable			1	(* 5)	
	Network cable			1	(* 5)	
Lens		C mount lens(*1)	—	1	Provided by customer (*2)	
24V power supply		— (*3)	—	1		
PC		—	—	1		
Hub		—	—	1		
Ethernet cable (straight)		—	—	4		
Lighting device		—	—	1		

(\*1) Select from general C mount lenses.

(\*2) The half tone (gray) section is the equipment provided by the customer.

(\*3) For the 24 VDC (±10%) power supply, the vision sensor requires a minimum of 350 mA(5403:a minimum of 500mA/ 5400R: a minimum of 250mA).

(\*4) Up to three robot controllers can be connected at the same time to one vision sensor, so prepare the "necessary quantity" for the number of robot controllers you use.

(\*5) It is attached to the network vision sensor set



## 3. Specifications

### 3.1. Network vision sensor specifications

Here are the specifications of the network vision sensor by itself.

Table 3-1 Network Vision Sensor Stand-Alone Specifications

		Standard 5100	High-Perfor mance 5400	Color 5400C (*1)	High-resolution		Remote Head 5400R (*1)		
					5401 (*1)	5403 (*1)			
<b>Magnificati on ratio</b>	Average performance with standard edition as 1 (*2)	x1	x2.5	x2			x2.5		
<b>Memory</b>		Vision program storage area		:32MB					
		Image processing area		:64MB					
<b>Firmware Version</b>		Ver. 3.2 or later							
<b>Camera</b>	Resolution	640x480		1024x768	1600x1200	640x480			
	CCD sensor size	1/3 inch			1/1.8 inch		1/3 inch		
	Color	x		○		x			
	Exposure[ms]	0.032-1000			0.027-1000		0.025-1000		
	Image capture speed (frames/sec.) (*3)	60		20		15		40	
	Capture[greytone]	256		16,777,216		256			
<b>Weight[g]</b> (lens cover mounted, no lens)	297.6					294.8			
<b>Display option</b>	VGA board	x							
	PC	○							
<b>I/O option (*6)</b>	Trigger/high-speed output count	○/2(*5)							
	I/O breakout expansion module	○							
	Ethernet I/O support (512 input max./512 output)	○							
<b>Interface (*6)</b>	Ethernet	○(Communication lines: 3 lines)							
<b>Lighting</b>	Integrated lighting option	○					x		
<b>Application development</b>	Controller pad/VGA	x							
	In-Sight Explorer/PC	○							
<b>Lens mounting</b>	C or CS	C					C/CS		
<b>Power supply</b>	Voltage condition	24VDC±10%							
	The maximum current	350mA			500mA		250mA		
<b>Image processing</b>		Pattern matching / Blob / Edge/Bar code 2D codes / Text comparison / Histogram / Color							
<b>Environme ntal</b>	Ambient temperature (operation / storage)	0 - 45°C / -30 - 80°C (*7)							
	Ambient humidity	90°C (no condensation allowed)							
	Protection	IP67 (When lens cover installed)							
	Impact[G]	80 (IEC68-2-27)							
	Vibration[G]	10 (10 - 500Hz IEC68-2-6)							
<b>Certificatio n</b>	CE, FCC, UL, CUL	○							

(\*1) High-resolution edition, Color edition and Remote-Head edition correspond from Ver.1.1 of MELFA-Vision.

(\*2) The performance values do not include the image capture speed.

(\*3) The image capture speeds are the values with an exposure time of 8 ms and full image frame capture.

(\*4) A lens cover (that comes with this sensor) is required that was designed to meet the NEMA standard protection specifications.

(\*5) One high-speed output is for strobe.

(\*6) I/O and Ethernet cable The maximum curve radius is 38 mm.

(\*7) The maximum operating temperature of the remote head is possible for 5400R up to 50°C.

### 3 Specifications

#### 3.1.1. External Dimensions of Network Vision Sensor(5100/5400/5401/5403/5400C)

Externals dimensions of Network Vision Sensor(5100/5400/5401/5403/5400C) is shown below. please refer when you fix the Vision sensor.

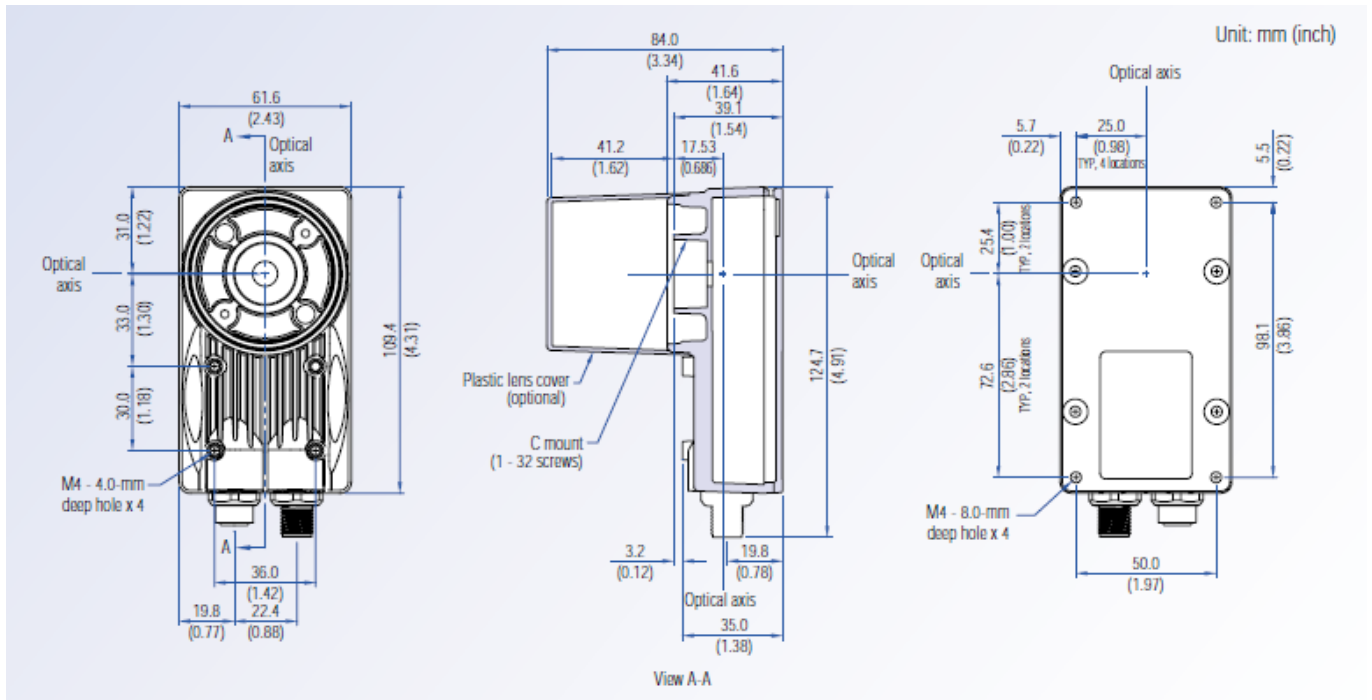

Figure 3-1 External Charts of Network Vision Sensor(5100/5400/5401/5403/5400C)

### 3.1.2. External Dimensions of Network Vision Sensor 5400R

Externals dimensions of Network Vision Sensor 5400R is shown below.  
please refer when you fix the Vision sensor.

Unit:mm

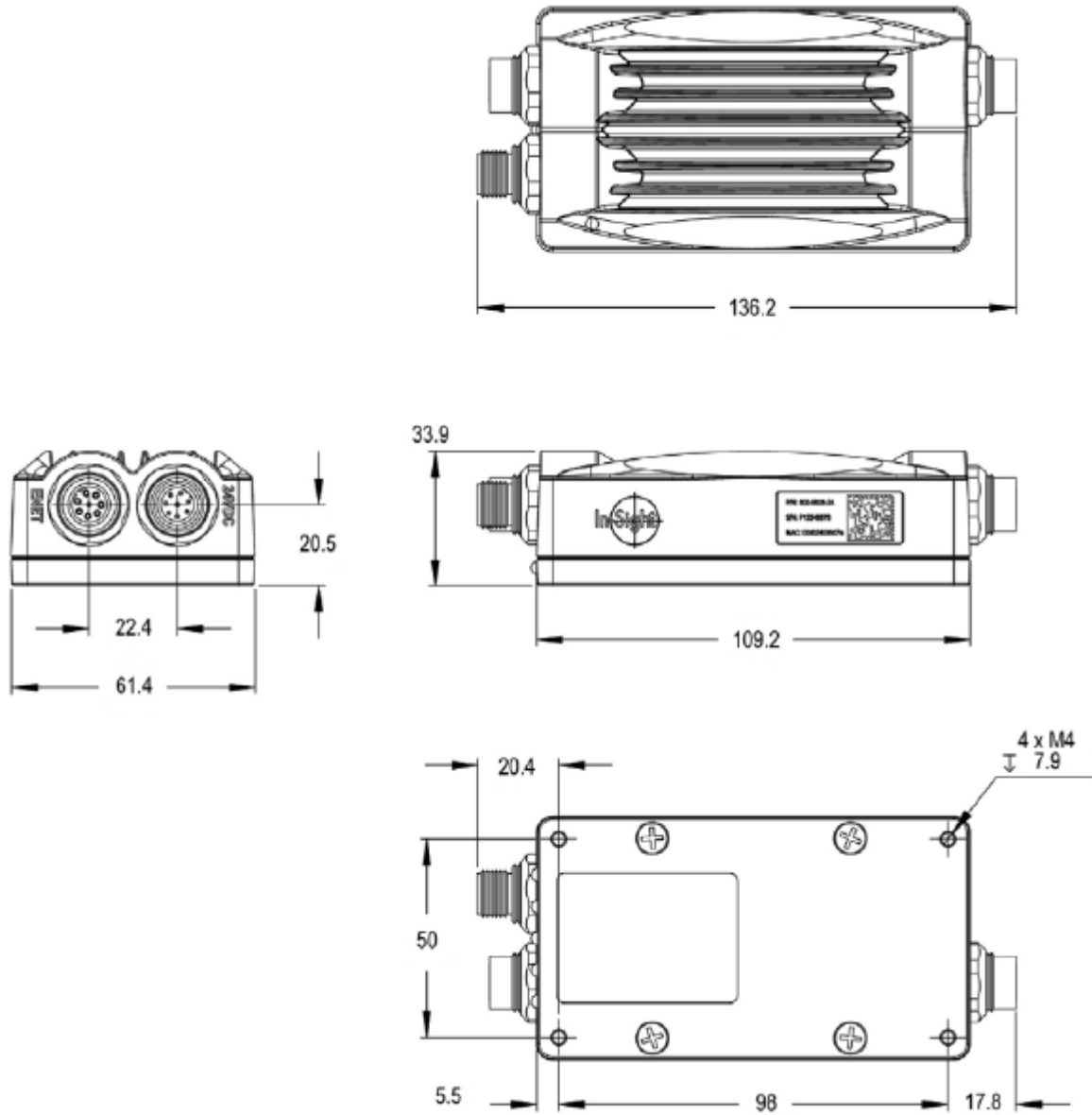

Figure 3-2 External Charts of Network Vision Sensor 5400R (Processor part)

Unit:mm

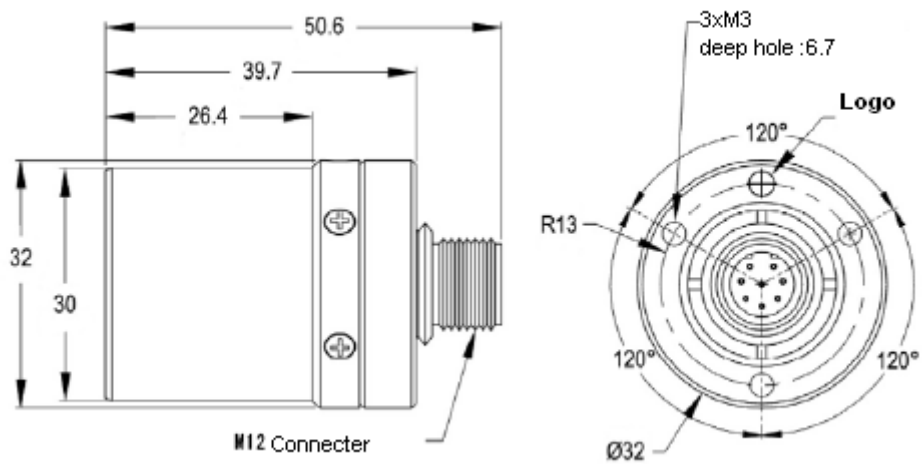

Figure 3-3 External Charts of Network Vision Sensor 5400R (Remote Head part)

Unit:mm

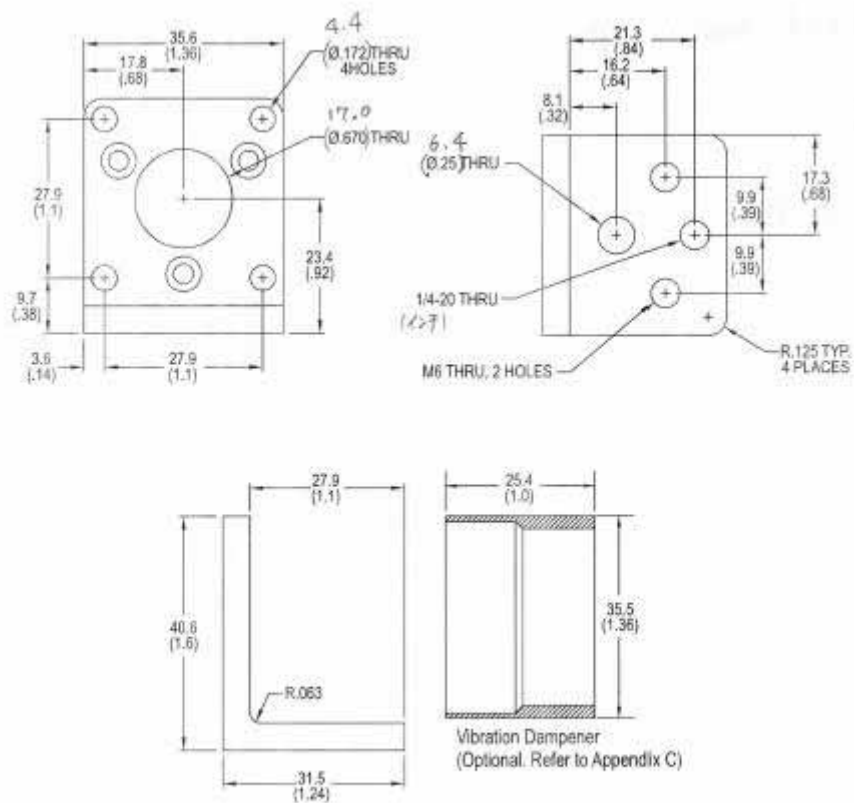

Figure 3-4 External Charts of Network Vision Sensor 5400R (Bracket part)

## 3.2. Robot controller specifications

The robot controller specifications related to the network vision sensor is shown below.

**Table 3-2 Robot Controller Specifications**

Item	Specifications
Software	Robot controller: Ver. K6 or later (*1) RT Toolbox: Ver.F3 or later are recommended. (*2)
Applicable robot controllers	All CRn-500 series controllers (*3)
Connectable robots	All robots (*4)
Options (*5)	Ethernet interface card (2A-HR533) required
Number of sensors and robots connectable	Number of cameras per robot controller : 7 maximum
	Number of robot controllers that can be connected per vision sensor : 3 maximum
Robot program language	MELFA-BASIC IV with special vision sensor commands

(\*1) Versions K5 and earlier can communicate with a vision sensor by combining the previous "Open/Print/Input/Close" commands.

Versions K7 and later can communicate with a vision sensor to high-speed by improved command.

(\*2) Versions F2 and earlier do not support MELFA-BASIC IV special commands for vision sensors, so errors occur in syntax checks, so use these versions without syntax checking.

(\*3) Ethernet functions must be mounted.

(\*4) Be careful. The robot types are restricted if tracking functions are used.

(\*5) For a CR1/CR1B controller, the expansion option box is required. For details on the expansion option box specifications and installation method, see the BFP-A8054 "CR1/CR1B Controller Instruction Manual" "From Controller Setup and Basic Operations to Maintenance" "3. Optional Equipment Installation".

Mount the Ethernet interface card (2A-HR533) in option slot 1.

## 3.3. MELFA-Vision

### 3.3.1. Features

MELFA-Vision is software that provides support for those using vision sensors for the first time and support for connections between robot controllers and vision sensors. Below are the basic functions and features of MELFA-Vision.

**Table 3-3 MELFA-Vision Basic Functions and Features**

	Function	Features
1	Logon and logoff	You log on to specify the vision sensors on the network and control them. Also, you log off to end control.
2	Image operations	Images captured with the vision sensor are operated on as follows.
	Capture request	This manually requests the vision sensor to capture an image and requests live (real time) capturing.
	Camera image adjustment	This changes the display magnification ratio for images captured with the vision sensor.
3	Online and offline	When a robot controller controls vision sensors, it is put online (making it controllable from the outside); when making such settings as vision program writing, changing, and deleting, it is put offline.
4	Vision program writing	This registers frequently used image processing (pattern matching, blob and color) as templates. Each of these image processing types easily using the setting screen with easy-to-understand work procedure. It is also possible to edit, delete, and change the name of written vision programs.
5	Recognition result display	The vision sensor image processing results can be displayed and the recognized quantity and recognized work position are checked.
6	Robot controller communication settings	It is easy to make settings for communicating between the robot controller and vision sensor.
7	Robot and vision sensor calibration	The position of work recognized by a vision sensor can be converted the robot coordinate system. In this way, work positions received from the vision sensor become positions at which the robot directly holds the work.
8	Image Log	Images recognized by a vision sensor can be stored on a PC. This makes it possible to analyze later pictures of work that could not be recognized and aids in finding the cause.
9	File transfer	Files can be transferred between a vision sensor and a PC.
	Backup	All data set on a vision sensor can be stored on a PC.
	Restore	Backup data stored on a PC can be returned to a vision sensor.
	Cloning	It is possible to set multiple vision sensors with the same settings as one vision sensor.

Version correspondence with the vision sensor by COGNEX and MELFA-Vision is shown in the following.

● : Indicates supported model name of each version

**Table 3-4 THE CORRESPONDENCE TYPE AND VERSION OF MELFA-VISION**

In-Sight model name	Specification	Ver.1.0	Ver.1.1	Ver.1.1.1	Ver.2.0
5100	Standard	●	●	●	●
5101	Standard + High resolution1 (1,024x768)		●	●	●
5103	Standard + High resolution2 (1,600x1,200)		●	●	●
5100C	Standard + color		●	●	●
5400	High performance	●	●	●	●
5401	High performance + High resolution1 (1,024x768)	●	●	●	●
5403	High performance + High resolution2 (1,600x1,200)	●	●	●	●
5400C	High performance+ color	●	●	●	●
5400R	High performance+ Remote head		●	●	●
5400S	High performance+ Stainless steel body			●	●
5403S	High performance + High resolution2 + Stainless steel body (1,600x1,200)			●	●
5400CS	High performance+ color + Stainless steel body			●	●
5600	High speed			●	●
5603	High speed + High resolution2 (1,600x1,200)			●	●
1100(Micro)	Micro standard			●	●
1400(Micro)	Micro high performance			●	●
1403(Micro)	Micro high performance + High resolution2 (1,600x1,200)			●	●
1100C(Micro)	Micro standard + color				●
1400C(Micro)	Micro high performance + color				●
1403C(Micro)	Micro high performance + High resolution2 (1,600x1,200) + color				●

### 3.3.2. Operating Environment

Below is the PC operating environment for MELFA-Vision.

**Table 3-5 MELFA-Vision Operating Environment**

Item	Requirement
CPU	Intel® Pentium® III 700MHz (or equivalent) or faster
Main memory	256 MB min.
Hard disk	Available capacity of 200 MB min.
OS	Microsoft® Windows® 2000, Service Pack 4 Microsoft® Windows® XP Professional, Service Pack 2
Display	An SVGA (800x600) or higher resolution display with graphic functions that can display at least 16 colors
Disc device	CD-ROM drive
Keyboard	PC/AT compatible keyboard
Pointing device	Device that operates in Windows® operating system
Communications	Must have Ethernet line that operates in Windows® operating system

# 4. Work Charts

## 4. 1. Work procedure chart

This chapter explains the work procedure for building a vision system using our robots. Check the following procedure before working.

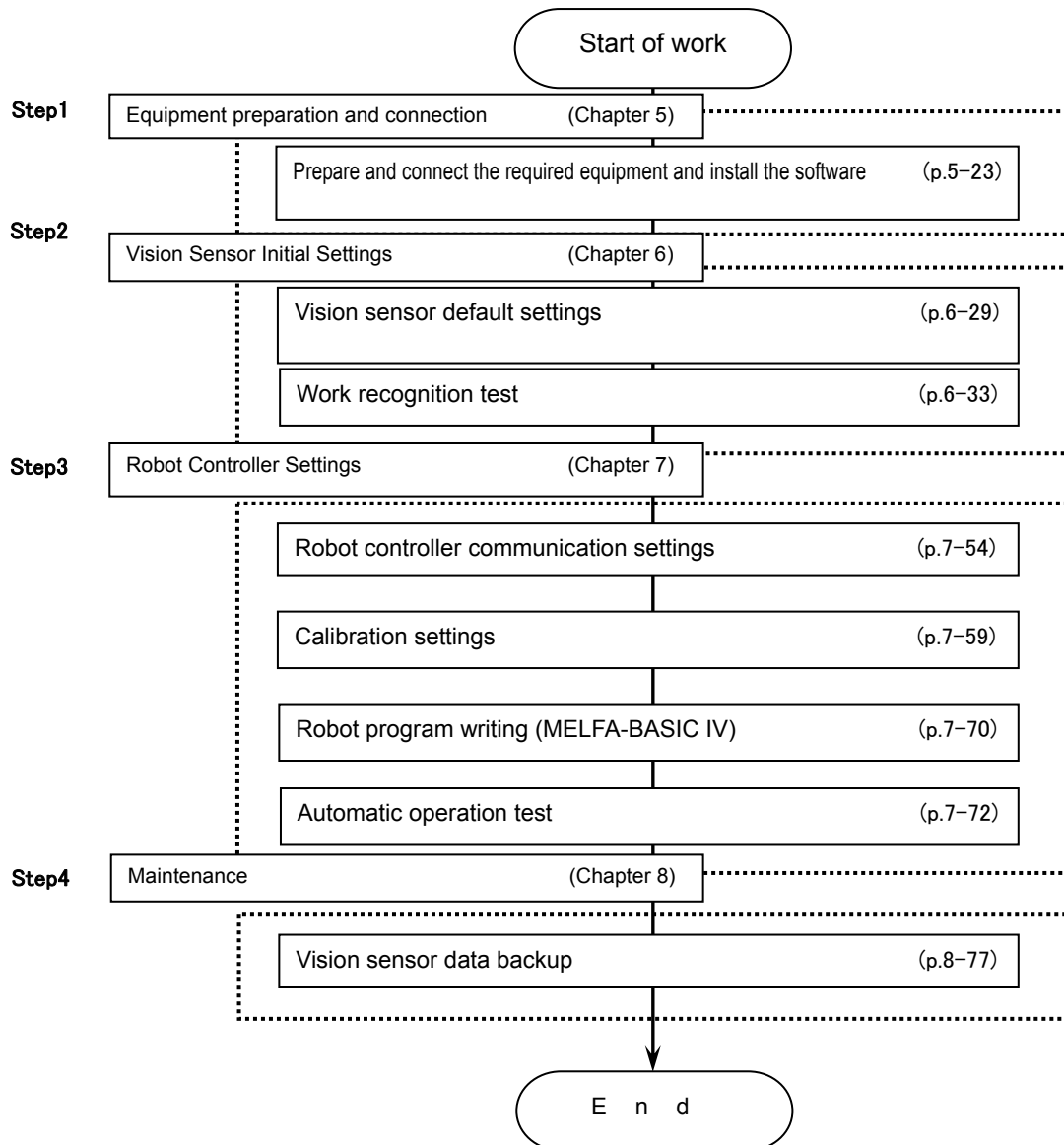



## 5. Equipment preparation and connection

This chapter explains how to prepare necessary equipment, connect it to the system, etc., using a system with one vision sensor and one robot controller as an example.

### 5.1. Equipment preparation

The following equipment is required for building the vision system. Included is equipment that must be provided by the customer, so prepare what is necessary for your system.

**Table 5-1 List of Configuration When One Camera Is Used**

Part name		Format	Manufacturer	Q'ty	Remarks
Robot controller		CRn-500 series	Mitsubishi Electric	1	Software: <b>K6</b> or later
Robot main unit		All models		1	
Teaching pendant		R28TB		1	
Ethernetinterface card(*1)		2A-HR533		1	
Network vision sensor basic set	Vision sensor	In-Sight 5000 series		1	Software: <b>3.20</b> or later
	Breakout cable			1	
	Network cable			1	
Lens		C mount lens		—	1
24V power supply		—	—	1	
PC		—	—	1	
Hub		—	—	1	
Ethernet cable (straight)		—	—	2	
Lightning device		—	—	1	
Robot hand		—	Mitsubishi	1	Equipment arranged for as necessary
Hand interface card		2A-RZ365	Electric	1	

(\*1) When a CR1 or CR1B robot controller is used, the expansion option box is required.

## 5. 2. Equipment connection

This section explains how to connect the equipment prepared.

### 5. 2. 1. Expansion option box installation (for CR1 controller)

A CR1 expansion option box is required in order to connect the Ethernet card to the CR1 controller. If the controller is a CR1 or CR1B, first install the expansion option box.

For any other controller, it is not necessary to install an expansion option box.

For details on the expansion option box installation method, see the BFP-A8054 "CR1/CR1B Controller Instruction Manual" "From Controller Setup and Basic Operations to Maintenance" "3. Optional Equipment Installation".

### 5. 2. 2. Mounting the Ethernet interface card (card name: HR533)

Install the Ethernet card in the robot controller. For details on robot controller handling, see the BFP-A8054 "CR1/CR1B Controller Instruction Manual" "From Controller Setup and Basic Operations to Maintenance" "3. Optional Equipment Installation".

For details on any controller other than a CR1, see the "CRn Controller Instruction Manual" "From Controller Setup and Basic Operations to Maintenance" "3. Optional Equipment Installation". (n = 2, 3, 4, 7, or 8)

### 5. 2. 3. Individual equipment connections

This section explains how to connect each piece of equipment.

For details on how to install the lens on the vision sensor main unit, how to install the breakout cable, and how to install the network cable, see the "In-Sight 5000 Series Installation Guide".

- (1) Install the C mount lens on the vision sensor. The C mount lens focal distance depends on the distance between the lens and the work and the field of vision the customer requires for image processing.
- (2) Connect the Ethernet cable to the connector (female) labeled "ENET".
- (3) Connect the breakout cable to the connector (male) labeled "24VDC".
- (4) Connect the other end of the 24V power supply with the "24VDC" (white/green) wire and the "GND" (brown) wire.
- (5) Connect the other end of the Ethernet cable to hub.

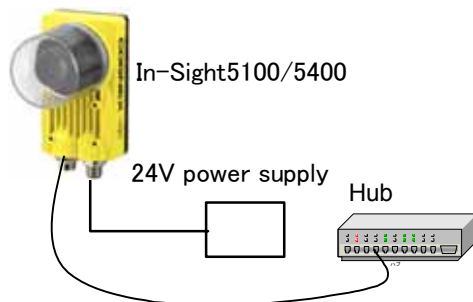

- (6) Connect the Ethernet straight cable to the hub and the other end to the PC.

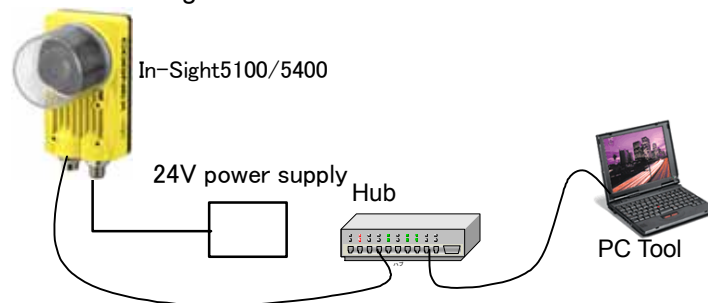

- (7) Connect the Ethernet straight cable to the hub and the other end to the robot controller's Ethernet interface card.

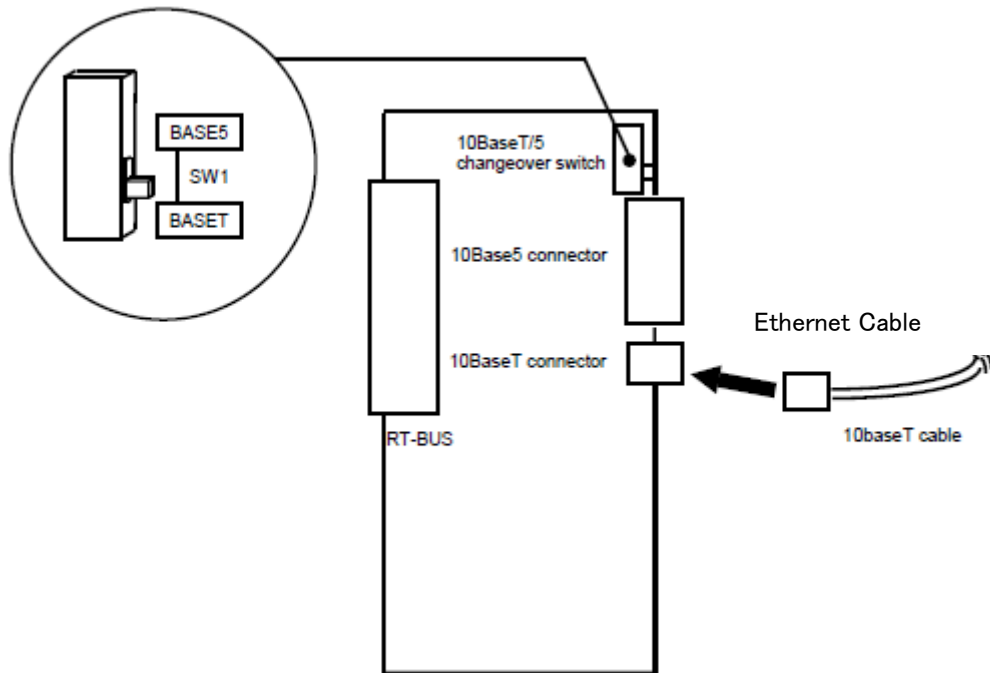

Figure 5-1 Ethernet Cable Connection

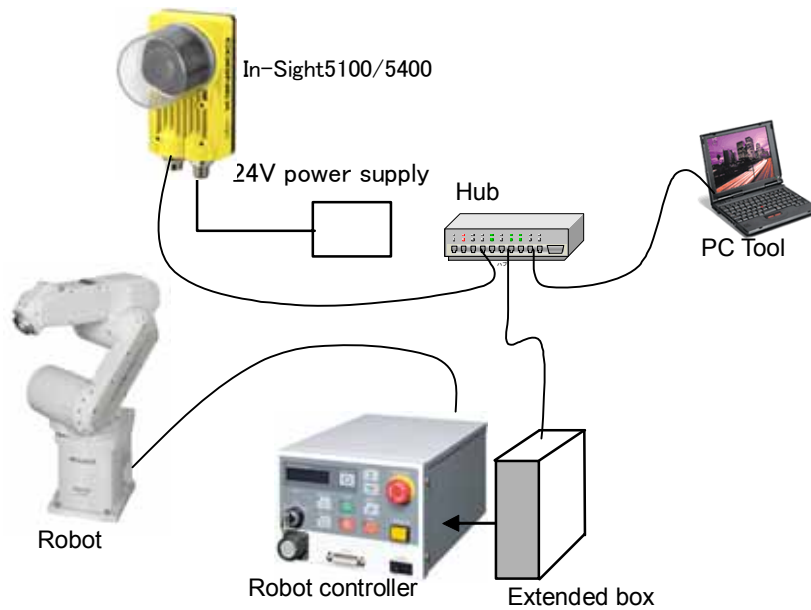

Figure 5-2 Completed System Configuration Diagram

### 5. 3. Software installation

This product comes with two CD-ROMs (In-Sight and MELFA-Vision). Each CD-ROM contains software necessary for starting up the vision system.

This section explains how to install this software.

Before installing the vision sensor dedicated software (In-Sight Explorer), always check the model and type of vision sensor and the version of the vision sensor dedicated software (In-Sight Explorer) being used.

Before installing MELFA-Vision, check the version of MELFA-Vision being used.

#### 5. 3. 1. Vision sensor dedicated software (In-Sight Explorer before Ver.4.1) installation

This section explains how to install the vision sensor dedicated software (In-Sight Explorer before Ver.4.1).

- (1) End all applications that are running.
- (2) Insert the In-Sight installation CD-ROM into the PC's CD-ROM drive. When the installation program starts automatically, the following screen is displayed.



Figure 5-3 In-Sight Software Setup Screen

- (3) Select the language displayed on the right side of the screen.
- (4) Click the [1] – [3] buttons in order to install the respective software.
- (5) For [4], click if your PC does not yet have Adobe Reader installed. Also click to install Adobe Reader if you have an older version.
- (6) When each piece of software has been installed, "Installed" is displayed next to that item on the installation program screen. Check that "Installed" is displayed next to [1] – [3]. Whether or not to install [4] is up to your judgment.
- (7) When the installation is complete, the icons for the installed software are displayed on the PC's desktop.

### 5.3.2. Vision sensor dedicated software (In-Sight Explorer Ver.4.1 or later) installation

This section explains how to install the vision sensor dedicated software (In-Sight Explorer Ver.4.1 or later).

- (1) End all applications that are running
- (2) Insert the In-Sight installation CD-ROM into the PC's CD-ROM drive. When the installation program starts automatically, the following screen is displayed.
- (3) Click the items indicated as not installed, and install each tool

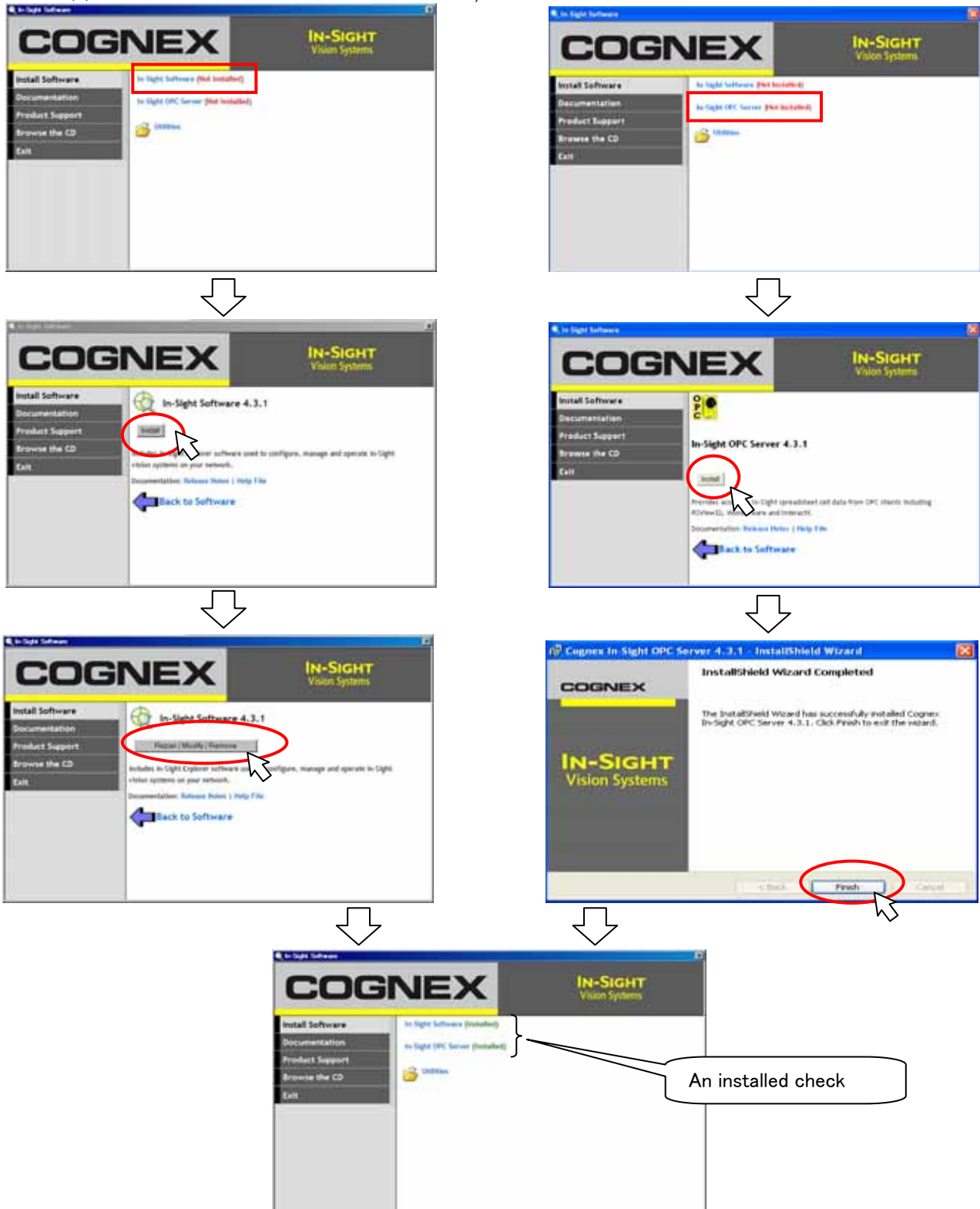

Figure 5-4 In-Sight Software Setup Screen

- (4) When installation is completed, the icon for the installed software will appear on the personal computer's desktop
- (5) Start the installed software to make sure it has been installed correctly

### 5.3.3. MELFA-Vision installation

This section explains how to install MELFA-Vision (network vision sensor support software).

Install this product with the following procedure.

- ◆ When "MELFA-Vision" is installed in the personal computer, ".NET Framework 1.1" is installed.
- ◆ If the OS is one of those followings, you must be logged on as an Administrator or as a member of the Administrators group in order to install this software.
  - Microsoft® Windows® 2000 Professional Operating System
  - Microsoft® Windows® XP Professional Operating System

- (1) Set this CD-ROM in the personal computer's CD-ROM drive. The Setup screen will be started up automatically.
- (2) If the screen does not start up automatically, carry out the following procedure.
  - (a) Select the [start] button and [run]
  - (b) Check the CD-ROM drive name. Input as shown below.  
"Drive name": \Setup.exe

(If the CD-ROM drive is "D:", this will be "D:\Setup.exe".)

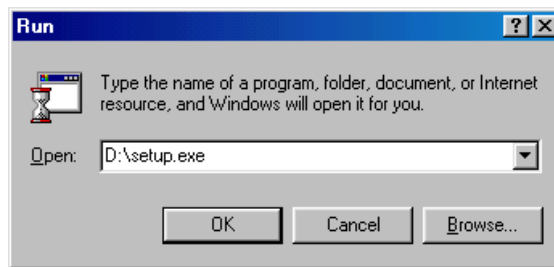
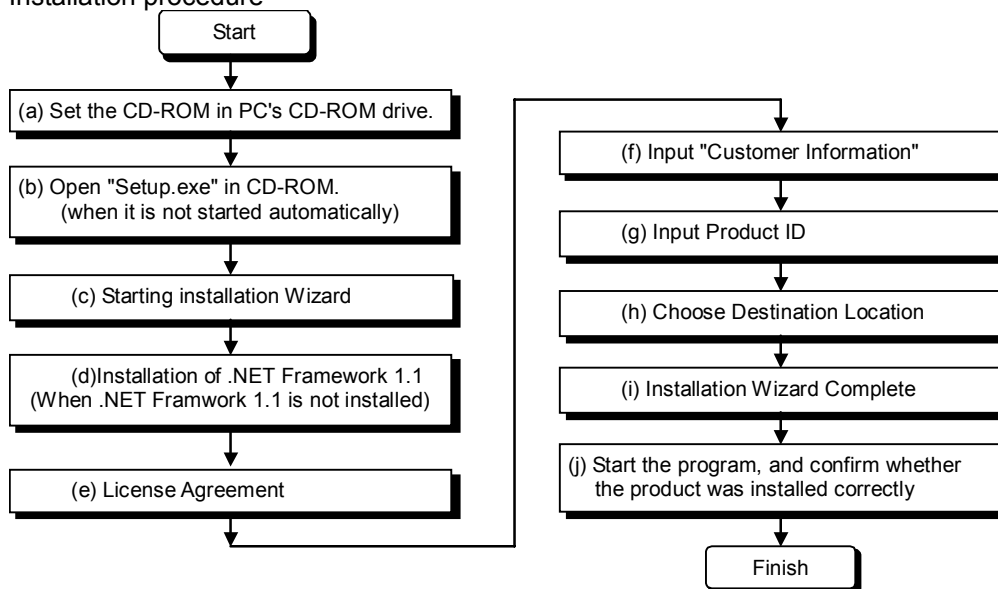

Figure 5-5 Run

- (3) Installation procedure



\* Product ID is printed on the License Certificate

Below are the contents of the CD-ROM.

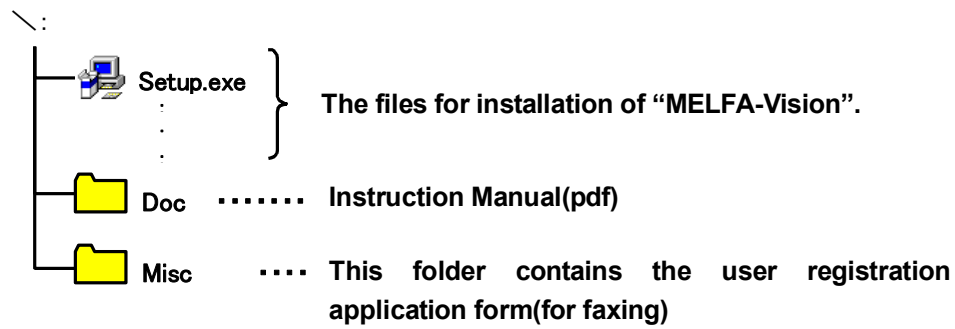

(4) Installation check

When the installation is complete, the installed software can be started from the Windows Start menu. For details, see "6.3.1 Starting MELFA-Vision (network vision sensor support software)".

## 6. Vision Sensor Settings

This chapter explains the vision sensor settings for recognizing work images.

### 6. 1. Vision Sensor Initial Settings

The first time you use your vision sensor, if you use a DHCP server, just switching on the power for the vision sensor automatically sets its IP address, but if you are not using a DHCP server, it is necessary to make this initial setting with the "In-Sight Connection Manager" installed with "5.3.1 Vision sensor dedicated software (In-Sight Explorer before Ver.4.1) installation". The method for this initial setting is as follows.

- (1) From the Windows Start menu, click the installed [In-Sight Connection Manager] to start "In-Sight Connection Manager".



Alternatively, double click  displayed on the desktop.

- (2) On the displayed screen select [Setup one or more In-Sight vision sensors to work on my network], then click the [Next] button.

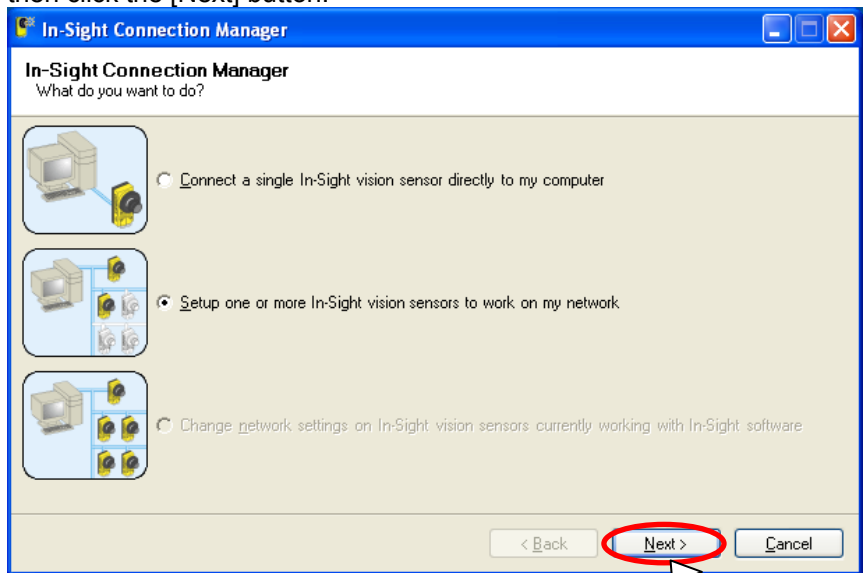

Key point: For details on the In-Sight connection manager, see the In-Sight Explorer help.



- (3) Input the MAC address listed on the vision sensor main unit sticker, then click the [Add] button. When connecting multiple vision sensors, add a MAC address for each vision sensor connected. Also, if you restart by switching Off, then On the power for all the vision sensors set, the MAC addresses are automatically displayed in a list.

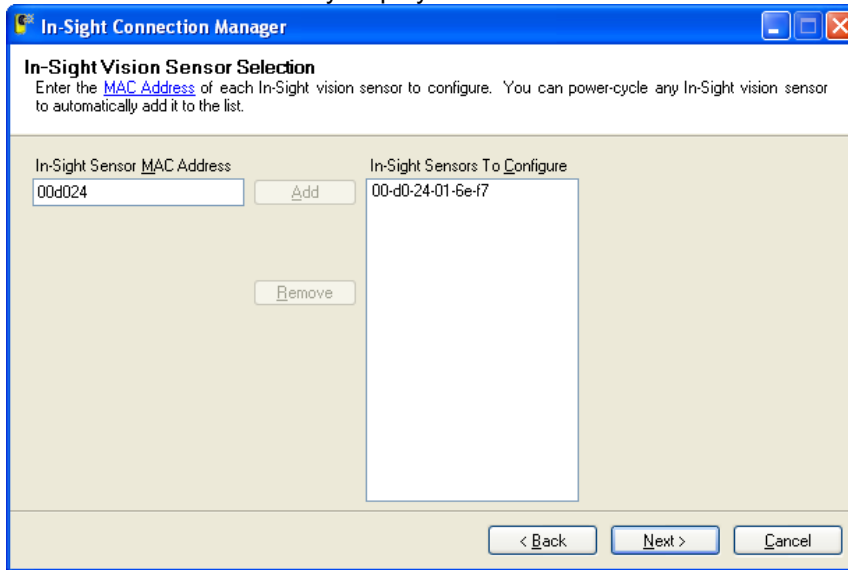

- (4) Click the [Next] button.

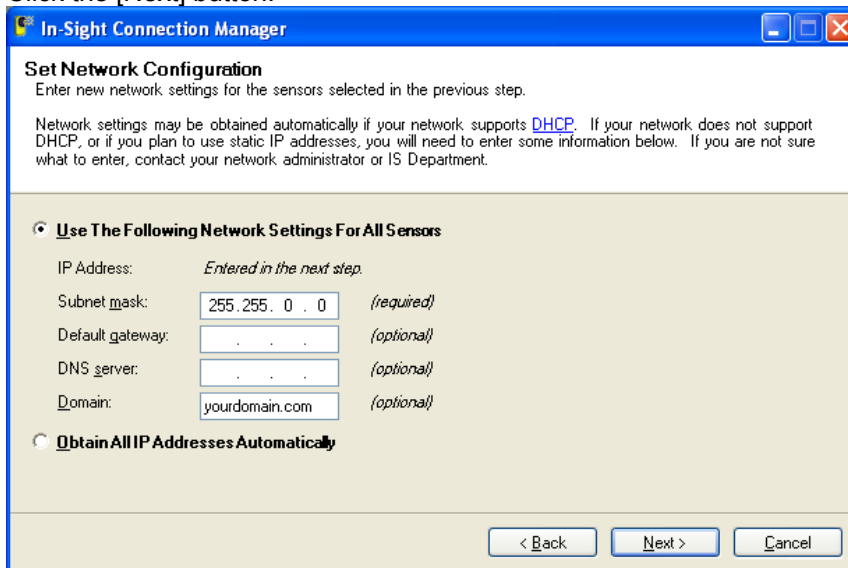

- (5) Your PC's [Subnet mask] (mandatory), [Default gateway] (option), [DNS server] (option), [Domain] (option) settings are automatically acquired and displayed. Check that these values are correct, then click the [Next] button.

- (6) Input the vision sensor [New Name] (host name) and [New IP], then click the [Next] button. Check with your network administrator for the IP address to set. Here is an example in which an IP address of "10.50.0.100" is set.

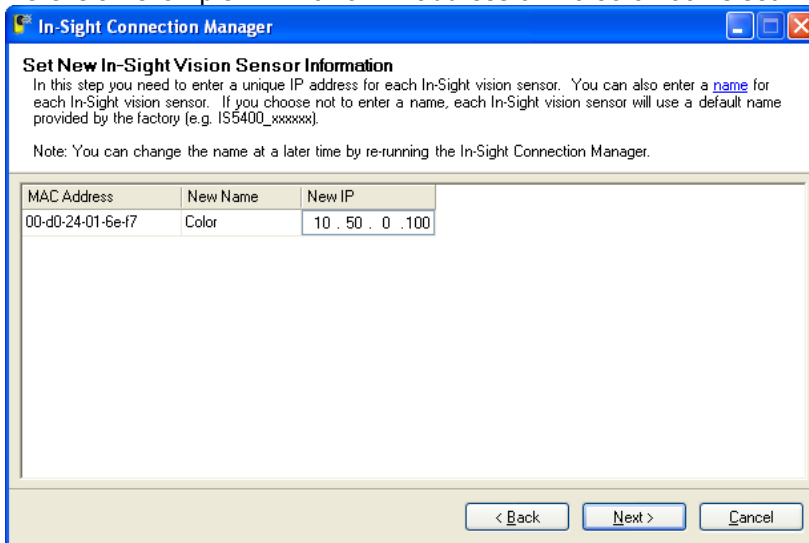

- (7) Click the [Configure] button, cut off the power for the vision sensor, wait at least 5 seconds, then switch the power back on again.

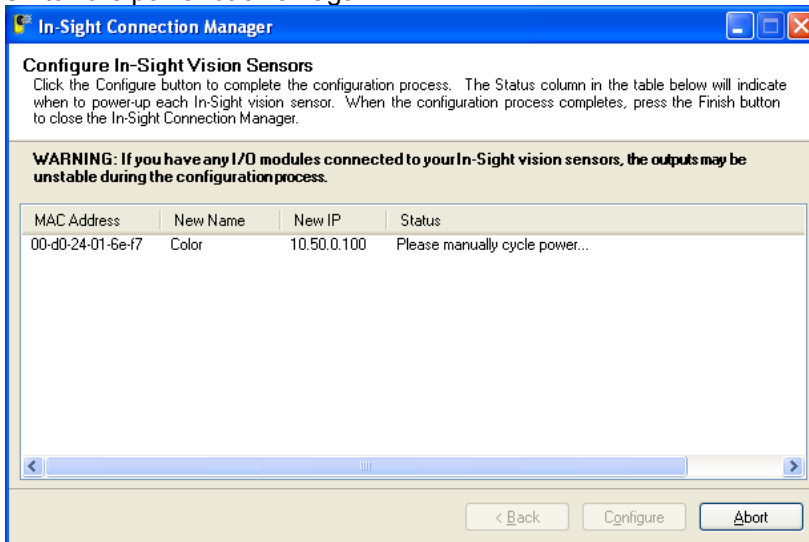

- (8) When "Settings complete" is displayed in the [Status] column, the settings are complete. Finally click the [Close] button to close the screen.

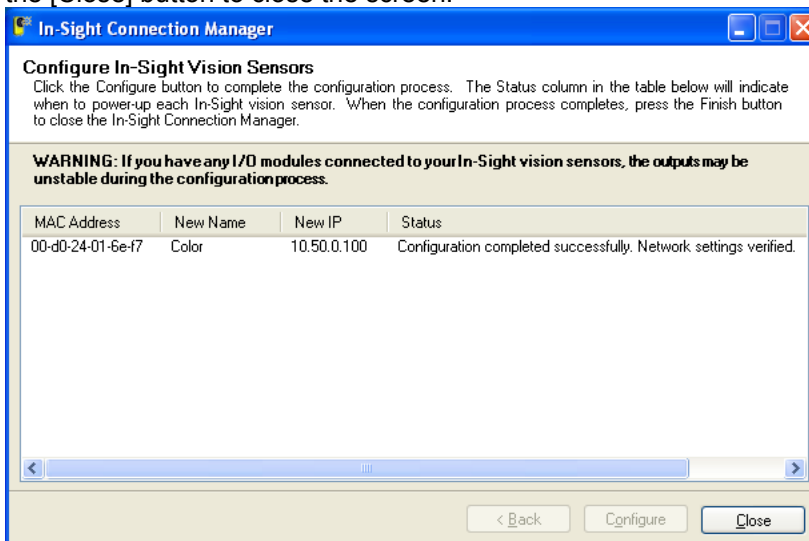

## 6. 2. Vision Sensor Initial Settings (In-Sight Explorer Ver.4.1or later)

The first time you use your vision sensor, if you use a DHCP server, just switching on the power for the vision sensor automatically sets its IP address, but if you are not using a DHCP server, it is necessary to make this initial setting with the "In-Sight Connection Manager" installed with 5.3.1Vision sensor dedicated software (In-Sight Explorer before Ver.4.1) installation. The method for this initial setting is as follows.

- (1) From the Windows Start menu, click the installed [In-Sight Explorer4.3.1] to start "In-Sight Connection Manager"

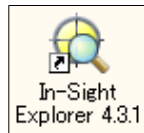

Alternatively, double click displayed on the desktop

- (2) Select and click [System] from the displayed screen's menu bar

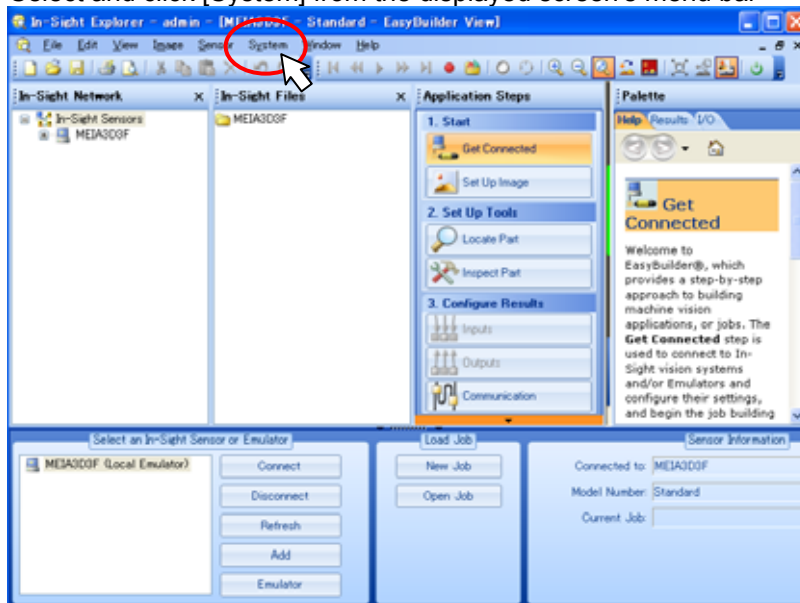

- (3) Select and click [Add Sensor/Device To Network] from the displayed screen's menu bar

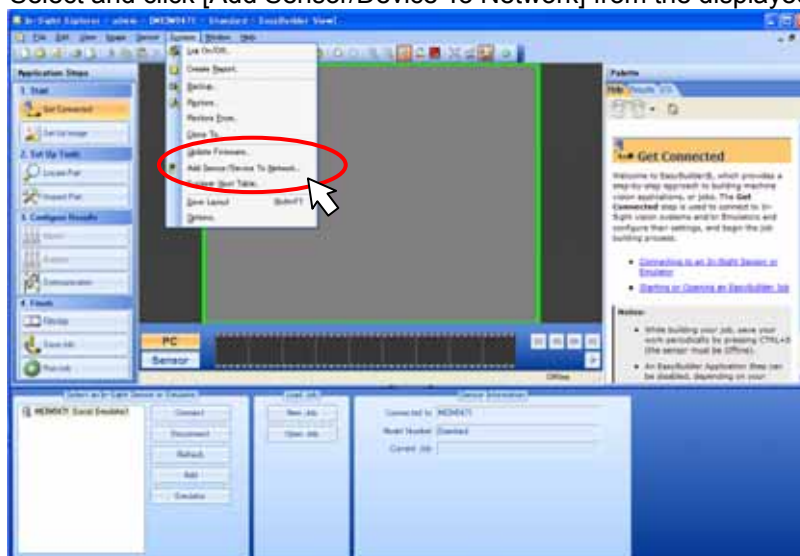

## 6 Vision Sensor Settings

- (4) The following screen appears when [Add Sensor/Device to Network] is selected. Click the [OK] button, and turn the vision sensor power OFF. Wait at least five seconds, and then turn the power ON again.

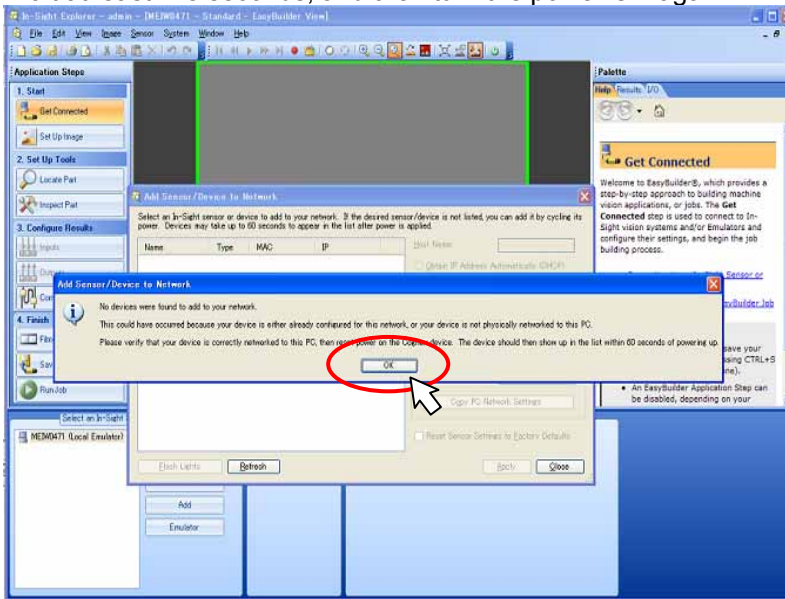

- (5) The devices to add to the network will appear, so select the displayed device and input the IP address. When finished inputting, click the [Close] button.

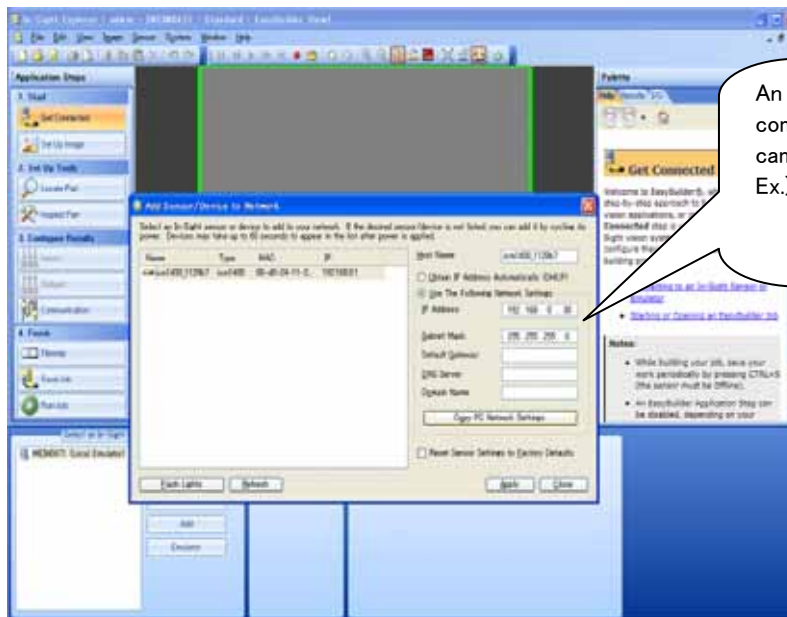

Key point: For details on the In-Sight connection manager, see the In-Sight Explorer help.

## 6.3. Work recognition test

This section explains how to register the work to be recognized with the vision sensor and how to test recognition of this work.

### 6.3.1. Starting MELFA-Vision (network vision sensor support software)

This section explains the procedure for starting MELFA-Vision, which can easily execute a work recognition test.

- (1) From the Windows Start menu, click [All Programs] – [MELSOFT Application] – [RT ToolBox] – [MELFA-Vision] to start "MELFA-Vision".

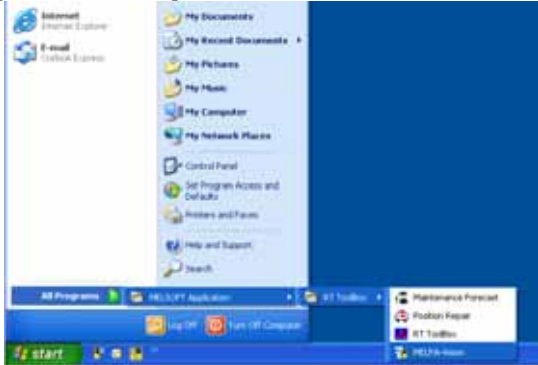

Alternatively, double click MELFA-Vision displayed on the desktop

- (2) Select the appropriate vision sensor from the displayed vision sensor list, then click the [Log On] button.

Input a [User Name] whose access rights for the vision sensor are "Full access" and the [Password], then click the [OK] button.

\* The [User Name] and [Password] are registered in the vision sensor. The default setting is a user name of "admin" with no password. If the user ID and password have been changed, input the new user name and password.

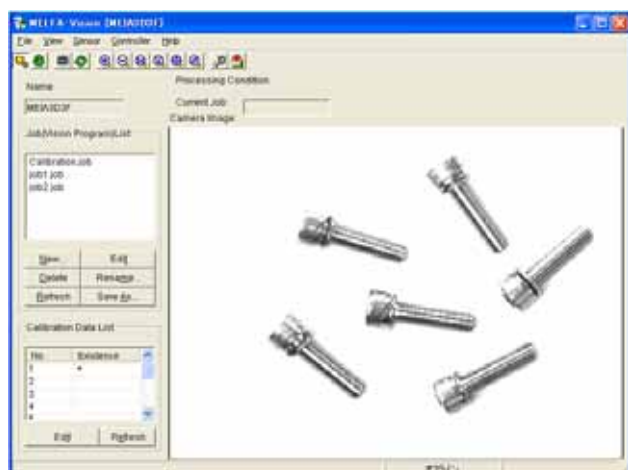
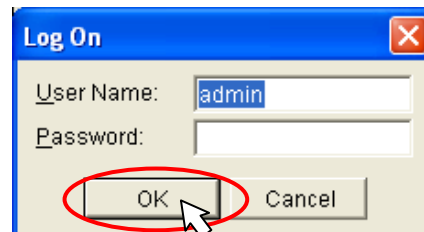
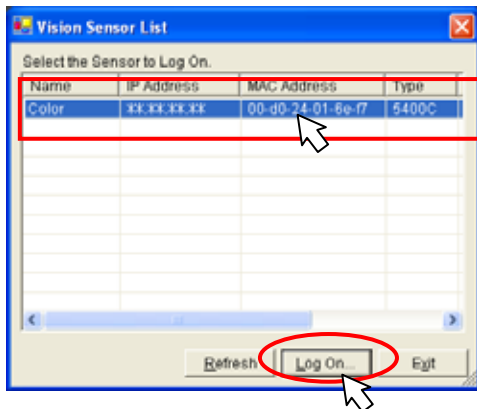

Figure 6-1 Starting MELFA-Vision

This section explains the MELFA-Vision main screen. For details on the MELFA-Vision functions, see "9.2 MELFA-Vision Function Details".

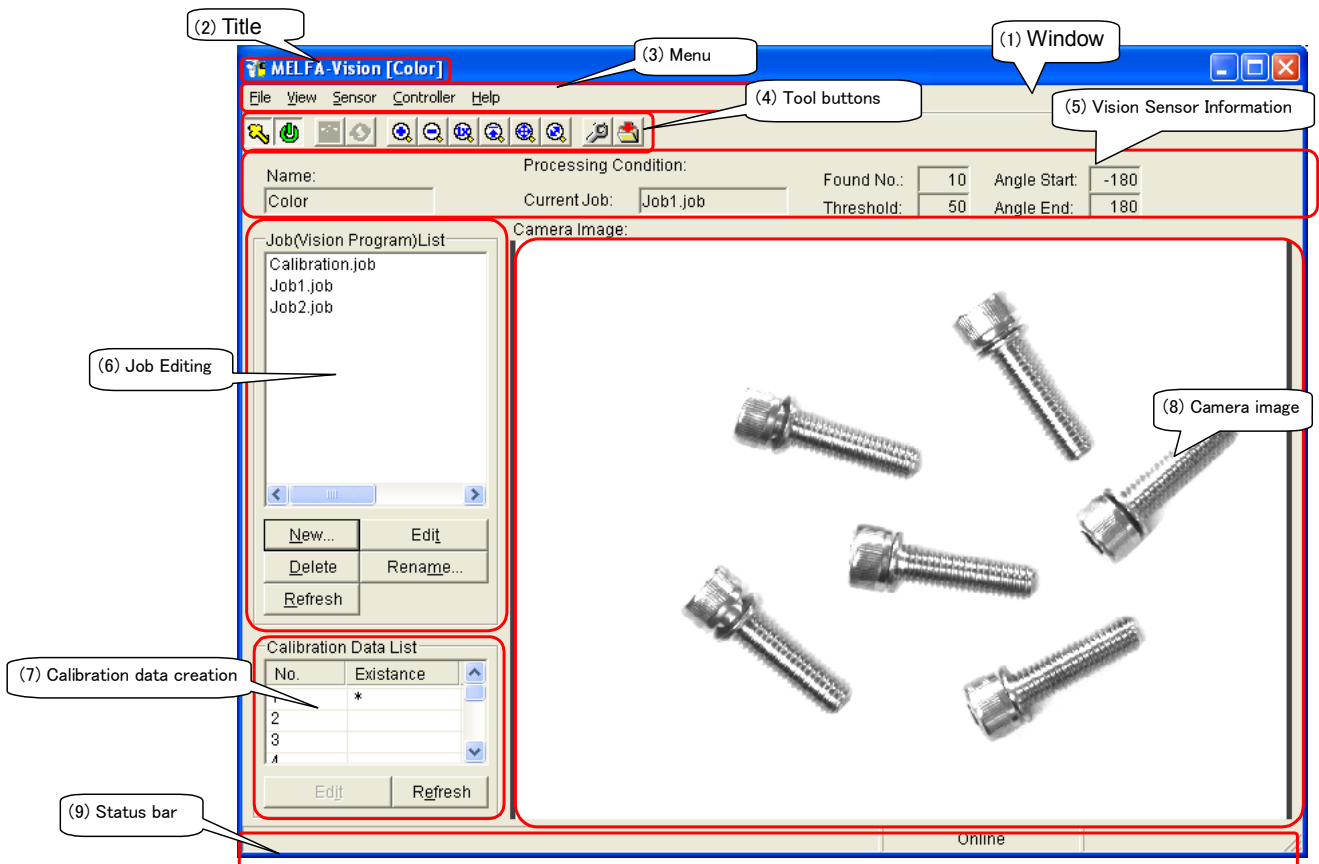

Figure 6-2 Main Screen

(1) Window

The default window size is "800x600".

(2) Title

The title character string is "MELFA-Vision [logged in vision sensor name]".

## (3) Menu

File View Sensor Controller Help

Table 6-1 MELFA-Vision Menu List

Menu	Item	Sub-item	Explanation	
File	Exit		Exits MELFA-Vision.	
View	Refresh Job Files		Updates the job list display on the left of the screen.	
	Refresh Calibration Data		Updates the calibration data list display at the bottom left of the screen.	
	Image	Zoom In		Raises the magnification ratio for display of the background picture.
		Zoom Out		Lowers the magnification ratio for display of the background picture.
		Zoom 1:1		Sets the magnification ratio for display to 1:1.
		Zoom to Max		Raises the magnification ratio for display of the background picture to the maximum.
		Zoom to Fit		Applies the background picture to the screen.
Zoom to Fill		Adjusts so that the picture is displayed on the entire screen.		
Sensor	Connection	Logon...	Logs on to make it possible to control the specified vision sensor.	
		Logoff	Logs off from the specified vision sensor.	
		Communication setting	Edits the vision sensor communication settings.	
	Adjust Lens...		Check the adjustment method for the lens mounted on the vision sensor.	
	Manual trigger		Requests the vision sensor to capture an image.	
	<input checked="" type="checkbox"/> Online		Select whether the vision sensor can be controlled from the outside (online) or editing of image processing (offline).	
	<input checked="" type="checkbox"/> Live Mode		Shoots continuously and recognizes images in real time.	
	Display Test Result(s)...		Monitors the information on the work recognized by the vision sensor.	
	Image Log	Setting...		This makes the FTP settings for storing images captured with the vision sensor to the PC.
		Start Log		Starts the image log.
		Quit Log		Quits the image log.
	User List...		Adds, edits, and deletes the user name and password with which the vision sensor is logged on to.	
	Startup...		This sets the initial state for when the vision sensor power has just been switched On.	
	Backup...		Backs up and restores the vision sensor setting contents. A clone can be prepared and copied to another vision sensor.	
	Restore...			
	Clone To...			
Delete Calibration Job		Deletes calibration data.		
Delete All Files		Deletes all the calibration data and vision programs.		
Controller	Communication setting...		This makes the settings for the line connection between the robot controller and vision sensor.	
	Monitor...		Monitors the data acquired by the robot.	
Help	About MELFA-Vision		Checks the MELFA-Vision version.	



(4) Tool buttons



Figure 6-3 Tool Bar

Table 6-2 Tool Button List

Button	Tool tip	Explanation
	Logon/Logoff	On: Logged on Off: Logged off
	Online/Offline	On: Online Off: Offline
	Manual Trigger	Each time this button is clicked, the image is shot.
	Live Mode	On: Live display underway Off: Live display ended
	Zoom In	Raises the magnification ratio for display of the background picture.
	Zoom Out	Lowers the magnification ratio for display of the background picture.
	Zoom to Max	Increases the background image's display magnification to the maximum.
	Zoom 1:1	Sets the magnification ratio for display to 1:1.
	Zoom to Fit	Adjusts the background image to the screen.
	Zoom to Fill	Adjusts the image so it is displayed on the entire screen.
	Image Log	This makes the settings for FTP transfer of images captured with the vision sensor to the PC.
	Start Log/Quit Log	On: Image log reception enabled Off: Image log reception disabled

(5) Vision Sensor Information

This displays the information for logged on vision sensors.

Name:  Processing Condition:  Found No.:  Angle Start:   
 Current Job:  Threshold:  Angle End:

Figure 6-4 Vision Sensor Information (Pattern Matching)

Table 6-3 Vision Sensor Information Items (Pattern Matching)

Control	Operation
Name	This is the host name of the vision sensor logged onto. Blank when vision sensor logged off.
Current Job	Displays the name of the job being edited.
Found No.	Displays the recognition count set with the recognition conditions on the job editing screen.
Threshold	Displays the threshold set with the recognition conditions on the job editing screen.
Angle Start	Displays the start angle set with the recognition conditions on the job editing screen.
Angle End	Displays the end angle set with the recognition conditions on the job editing screen.

Name:  Processing Condition:  Color:  Area Limit:   
 Current Job:  Found No.:  Threshold:  Greyscale:   
mera Image:

Figure 6-5 Vision Sensor Information (Blobs)

Table 6-4 Vision Sensor Information Items (Blobs)

Control	Operation
Color	Displays the background color and the target color for recognition set with the color setting on the job editing screen.
Area Limit	Displays the minimum and maximum values set with the work surface area on the job editing screen.
Greyscale	Displays the threshold for the grayscale minimum set with the grayscale threshold value on the job editing screen.



## (6) Job Editing

A list of the job files for the logged on vision sensors is displayed and job files are managed (created, edited, name changed, updated).

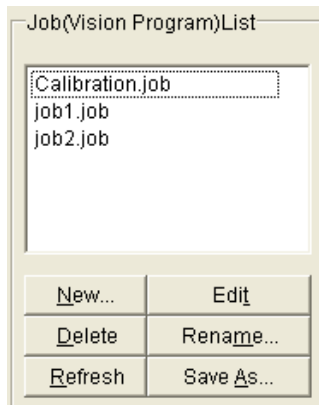

Button	Explanation
New (N)	A job (vision program) is created newly.
Deletion (D)	A job is deleted.
Renewal (R)	A job list is renewed.
Edit (T)	A job is edited (change).
Name change (M)	The name of a job is changed.
Alias preservation (A)	The job is named and saves

Figure 6-6 Job (Vision Program) List

## (7) Calibration data creation

A list of the calibration for the logged on vision sensors is displayed and calibration data is created.

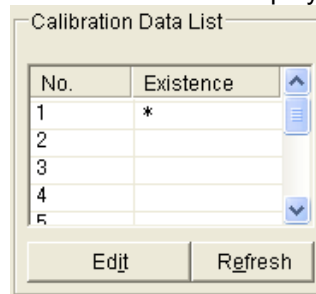

Figure 6-7 Calibration List

## (8) Camera image

This displays the logged-on camera image. Black when logged off.

## (9) Status bar

This displays the vision sensor mode, image information for the mouse position, and PC image log reception status.

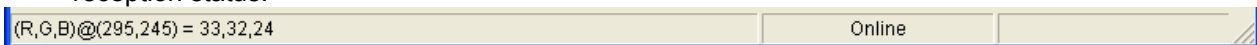



Figure 6-8 Status Bar

Table 6-5 Status Bar

Control	Explanation
Left frame	This displays the mouse position image information. (X coordinate value, Y coordinate value) = Contrast value
Center frame	When the vision sensor status changes, the following character strings are displayed. Anything else is blank. <ul style="list-style-type: none"> <li>▪ "Online"</li> <li>▪ "Offline"</li> <li>▪ "Live"</li> <li>▪ "Incomplete online"</li> <li>▪ "Discrete online"</li> </ul>
Right frame	This displays the PC image log reception status. When reception enabled: "Image log reception enabled" When disabled: Blank

### 6.3.2. Image adjustment

This section explains how to adjust the brightness and Diaphragm for the image captured by the vision sensor.

- (1) Check the image shot with MELFA-Vision [Camera Image].  
From MELFA-Vision menu, click [Sensor] – [Live Mode] or click  from the tool bar to put MELFA-Vision into live image mode. Put the work to be recognized under the vision sensor and check the resulting image with MELFA-Vision [Camera Image].

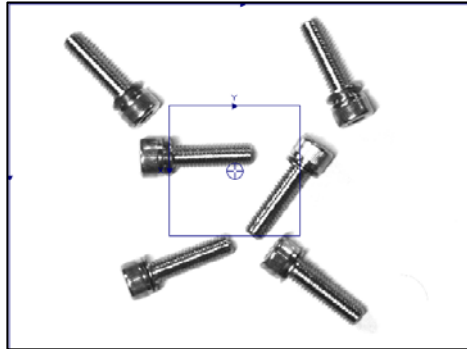

Figure 6-9 Image Check Example

- (2) If the field of vision is not appropriate, adjust the distance between the vision sensor and the work or replace the lens.
  - ① When the image is too large

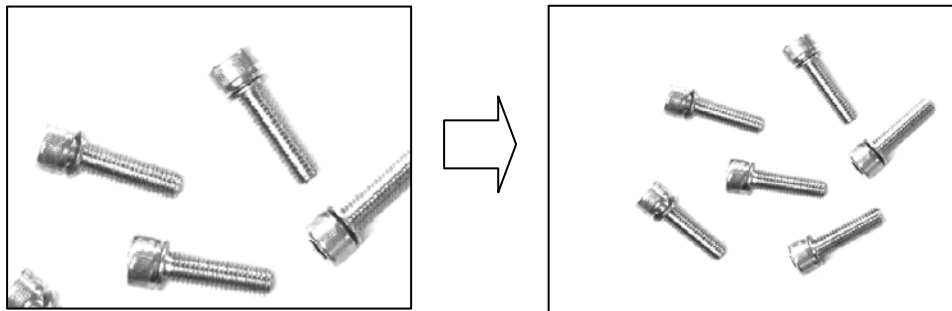

Figure 6-10 Example in Which the Image Is Too Large

- ② When the image is too small

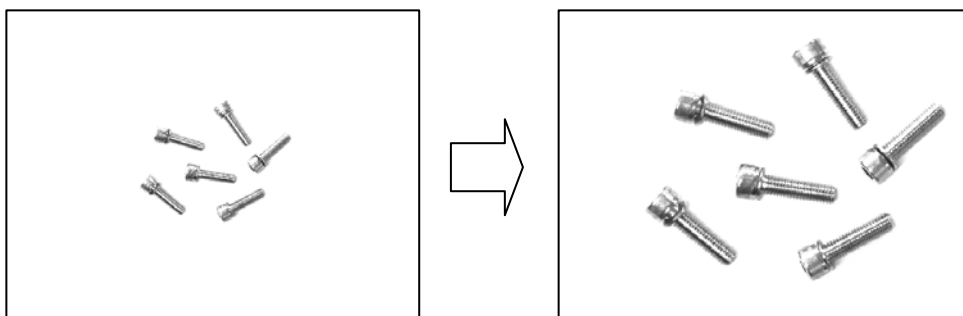

Figure 6-11 Example in Which the Image Is Too Small

(3) If the brightness is not appropriate, adjust the lens "Diaphragm".



Figure 6-12 Camera Lens adjustment

If the appropriate brightness can not be achieved by just adjusting the Diaphragm, provide different lighting.

① Too bright

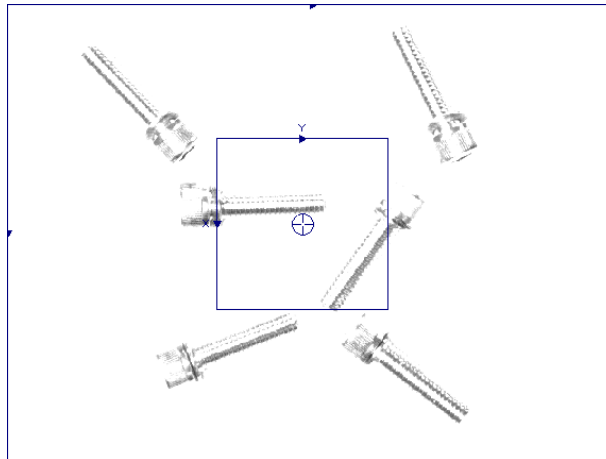

Figure 6-13 Example in Which the Image Is Too Bright

② Too dark

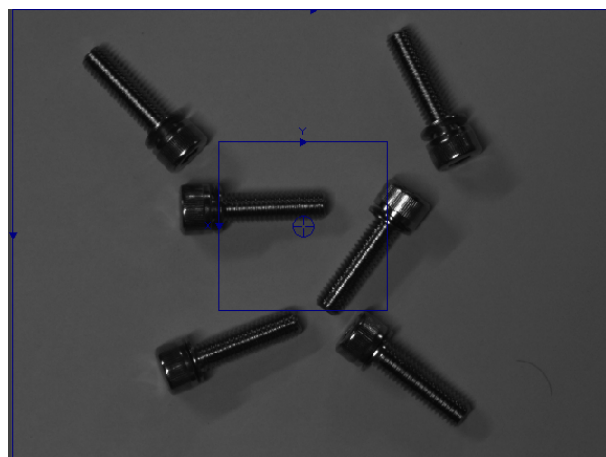

Figure 6-14 Example in Which the Image Is Too Dark

(4) If the focus is not appropriate, adjust the lens "focus".

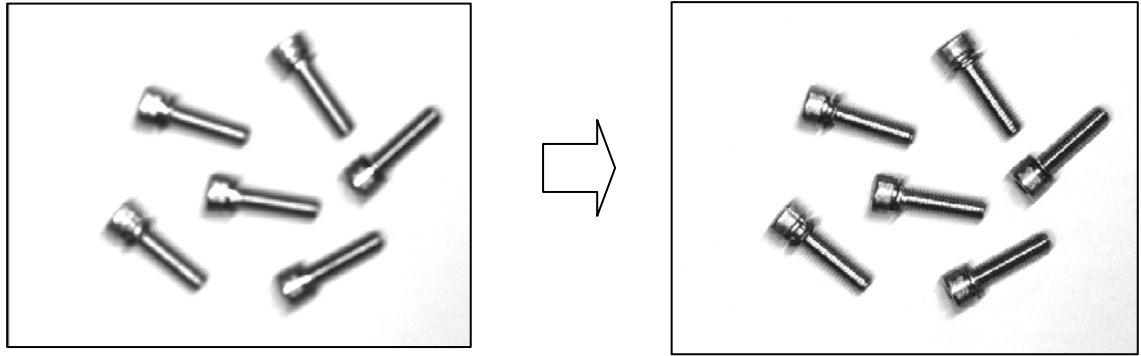

Figure 6-15 Example in Which The Image Is Out of Focus

### 6.3.3. Image processing settings

This section explains how to make the image processing settings, using pattern matching image processing (only one robot, results output as robot absolute coordinate values) as an example. For details on other image processing, see "9.3.1 Templates provided for MELFA-Vision".

- (1) Click [New] under Job (Vision Program) List at the left of the MELFA-Vision main screen. Select the process method from the displayed [Processing Method] screen, and then click the [OK] button.

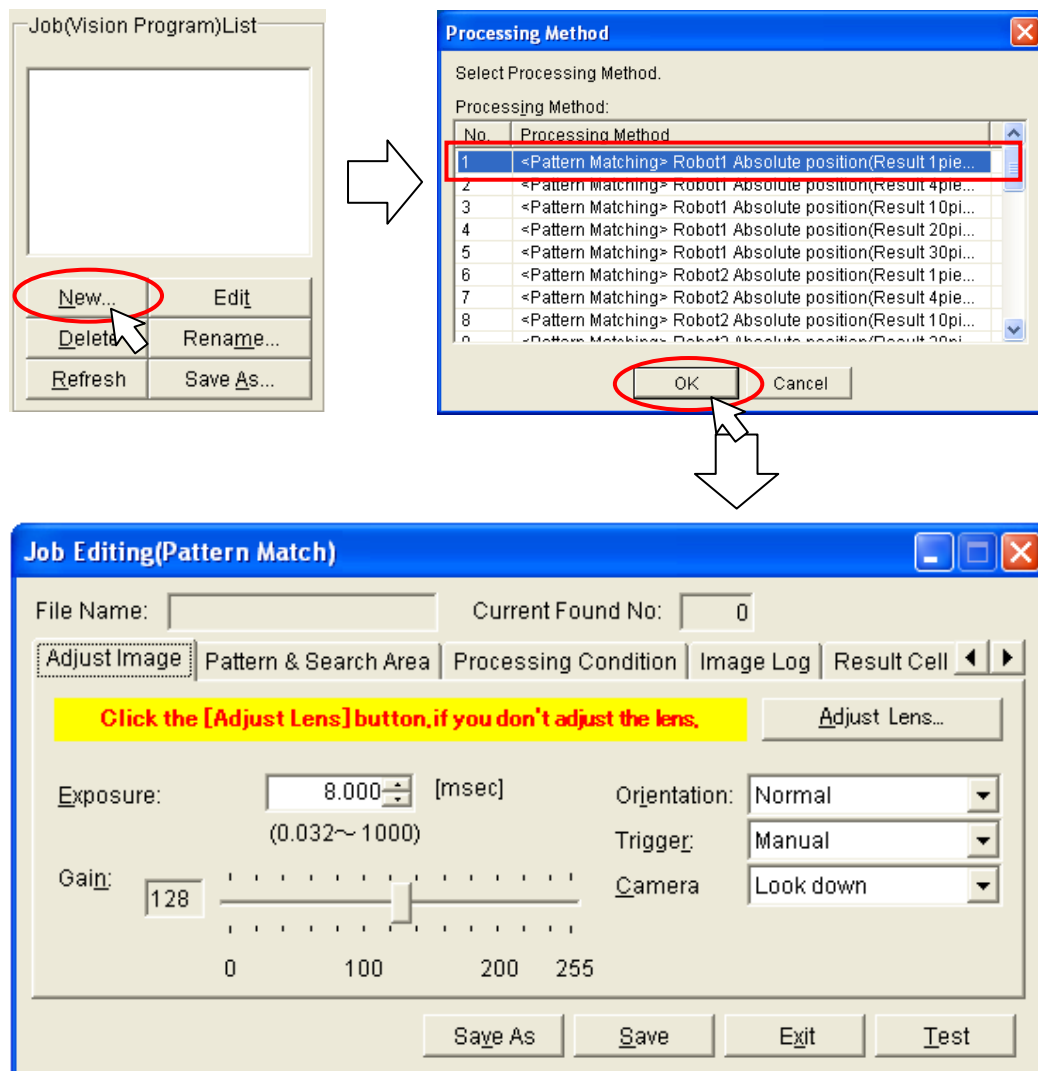
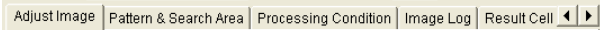
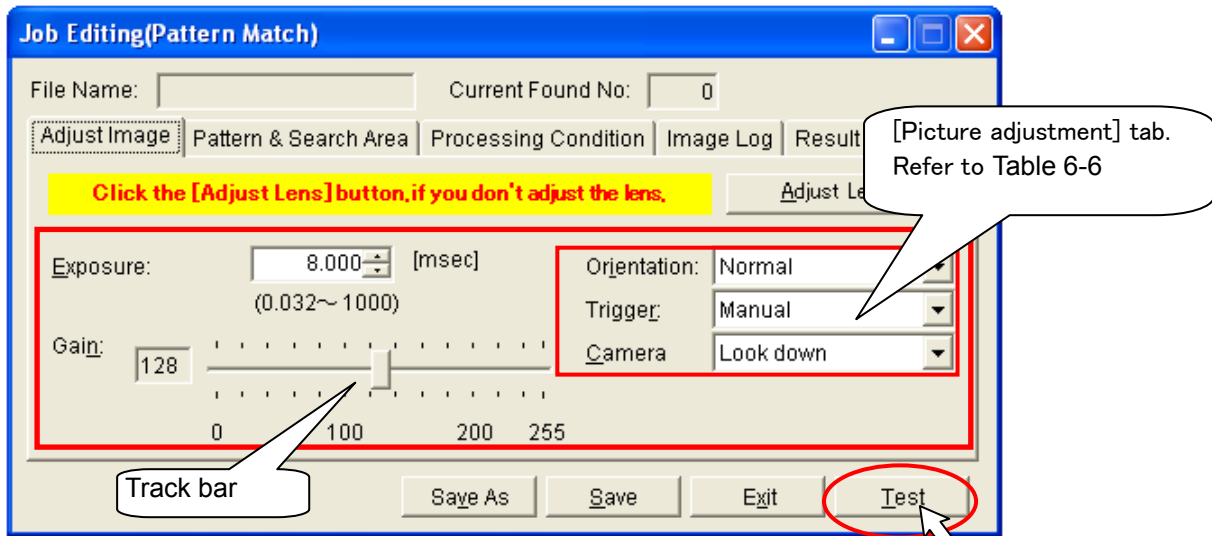



Figure 6-16 Selection of Image Processing Method



- (2) Execute the work in order of the  tabs from left to right on the displayed "Job Editing" screen. First, adjust the image with the [Adjust Image] tab.

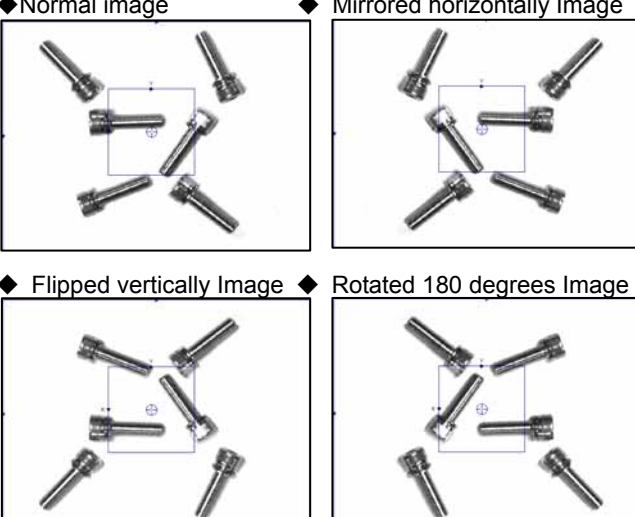

- (3) When you change all the displayed items, then click the [Test] button, the picture is displayed for when the setting is changed to the main screen [Camera Image], so adjust for clear contrast between the work and the background. For details on the setting items, see below.

Table 6-6 List of [Adjust Image] Tab Items

Setting item	Setting range	Explanation
Exposure	0.032 - 1000	This adjusts the exposure time for images captured. Lowering this value shortens the image take-in time and reduces the amount of light accumulated on the CDD array, so the image becomes darker. On the other hand, if this value is raised, the amount of light accumulated increases, so the image becomes brighter.
Gain	0 - 255	This adjusts the image brightness. Adjust by moving the track bar left and right. <ul style="list-style-type: none"> <li>◆ When value decreased</li> <li>◆ When value increased</li> </ul> 
Orientation	Normal Mirrored horizontally Flipped vertically Rotated 180 degrees	This changes the direction in which the image is displayed. <ul style="list-style-type: none"> <li>◆ Normal image</li> <li>◆ Mirrored horizontally Image</li> <li>◆ Flipped vertically Image</li> <li>◆ Rotated 180 degrees Image</li> </ul> 

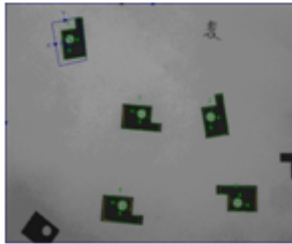
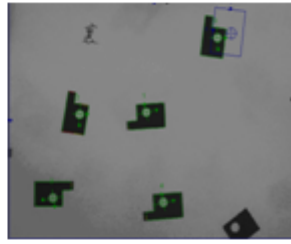
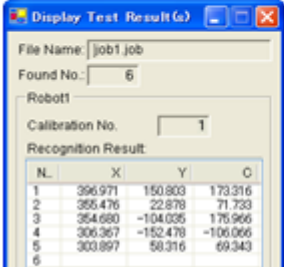
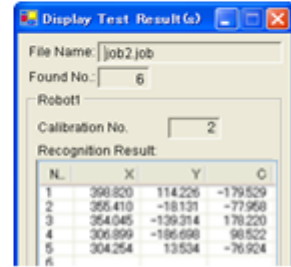
Setting item	Setting range	Explanation
Trigger	Camera Continuous External Manual Network	<p>This specifies the image take-in trigger for when the vision sensor is "online".</p> <p>[Camera] The image is taken in at the rising edge detected at the camera hardware trigger input port.</p> <p>[Continuous] Images are taken in continuously.</p> <p>[External] The image is taken in at the rising edge of a discrete I/O (*1) input bit or serial command.</p> <p>[Manual] The image is taken in when the &lt;F5&gt; key is pressed.</p> <p>[Network] The image is taken in when the trigger is input to the master vision sensor on the network.</p>
カメラ方向 (上下設置方)		<div style="display: flex; flex-wrap: wrap;"> <div style="width: 50%; text-align: center;">  </div> <div style="width: 50%; text-align: center;">  </div> <div style="width: 50%; text-align: center;">  </div> <div style="width: 50%; text-align: center;">  </div> <div style="width: 50%; text-align: center;">  </div> <div style="width: 50%; text-align: center;">  </div> </div> <p><b>【Direction of a camera】</b> Facing down or facing up is specified with the [Camera] tab.</p> <p><b>【Photography picture】</b> A picture becomes a front side and the back side by the direction of a camera.</p> <p><b>【Recognition result】</b> If the recognition result has the the same coordinates of a vision sensor and a robot when the same work is photographed facing up and downward, C axis component will turn into an axial component of downward (front side ) plus and upward (reverse side) minus.</p>

(\*1) For details on discrete I/O, see the "In-Sight Installation Guide" that comes with this system.

- (4) The area in which work is detected, registration of work to search for, and the work position output to the robot are set with the "Job Editing" screen [Pattern & Search Area] tab.

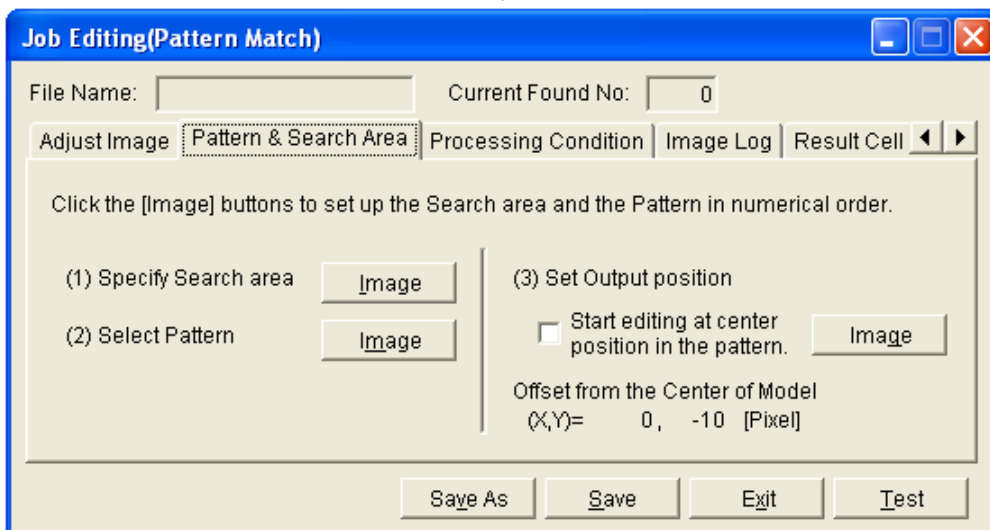
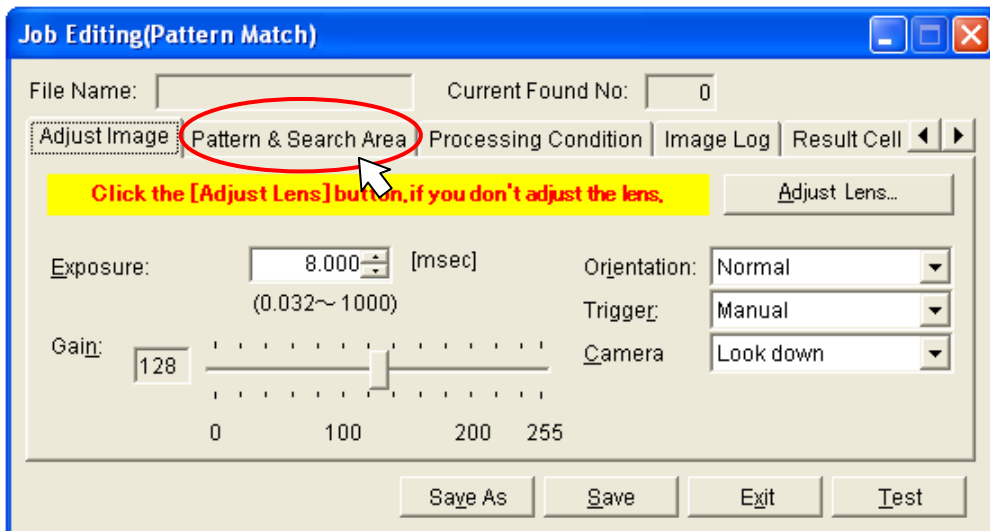



## (4-1) Determining the search area

When you click the "Search area" [Image] button, the focus shifts to the main screen and a red frame is displayed around [Camera Image] on the main screen. The registered work is detected from the area enclosed by the red frame. The area in which the work is detected can be changed with the mouse or keyboard.

If you use the keyboard, each time the [F9] key is pressed, the "area adjustment mark" changes and fine adjustments can be made with the [arrow keys]. To finalize the area, press the [OK] key; to cancel it, press the [Cancel] key. The focus returns to the "Job Editing" screen.

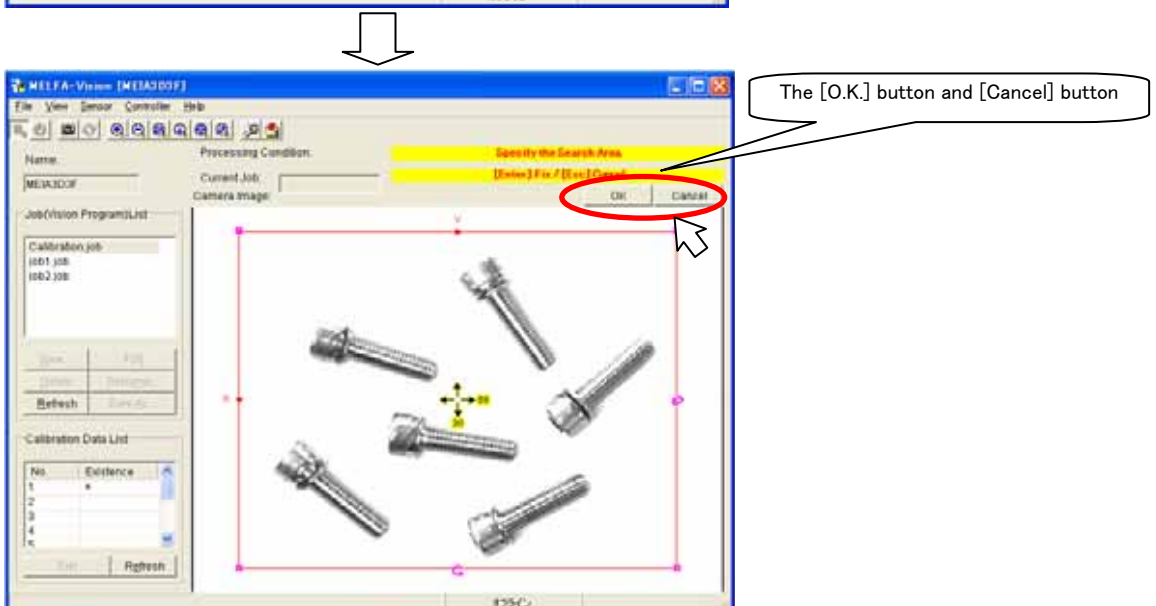
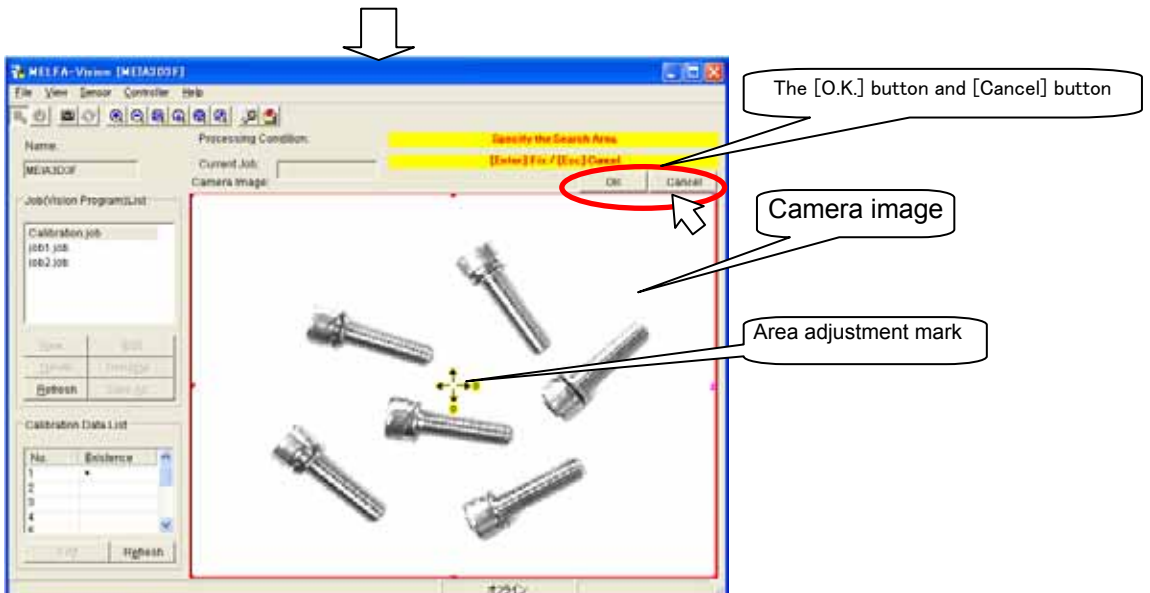
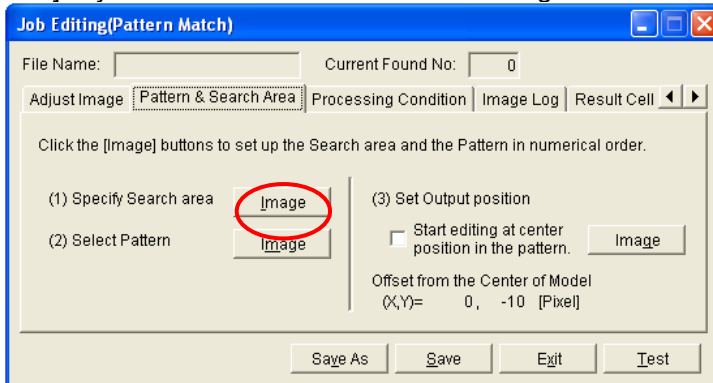

(4-2) Determining the recognition pattern

When you click the "Pattern select" [Image] button, the focus shifts to the main screen and a red frame is displayed around [Camera Image] on the main screen. The registered work is enclosed by the red frame. For operations, use the mouse or keyboard. If you use the keyboard, each time the [F9] key is pressed, the "area adjustment mark" changes and fine adjustments can be made with the [arrow keys]. To finalize the pattern selection, press the [OK] key; to cancel it, press the [Cancel] key. The focus returns to the "Job Editing" screen.

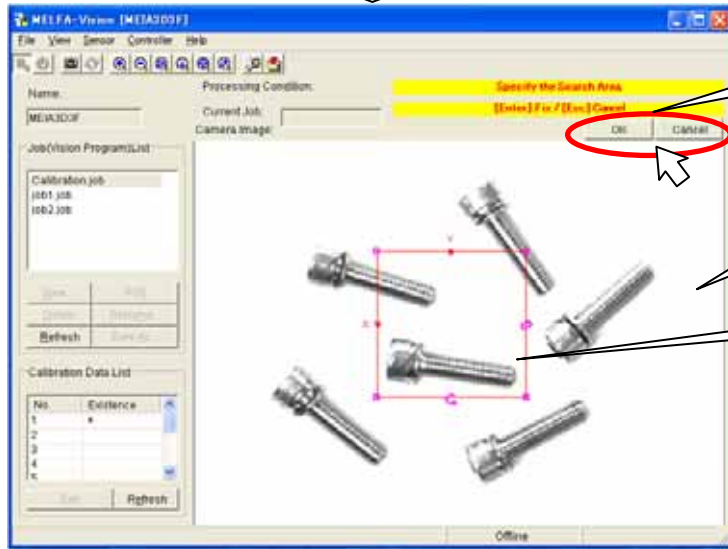
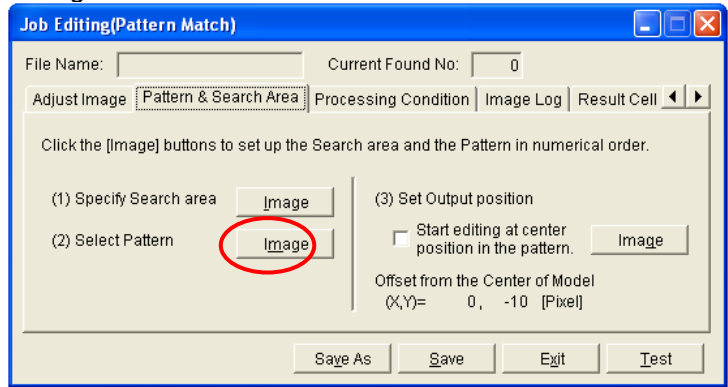

The [O.K.] button and [Cancel] button

Camera image

Area adjustment mark

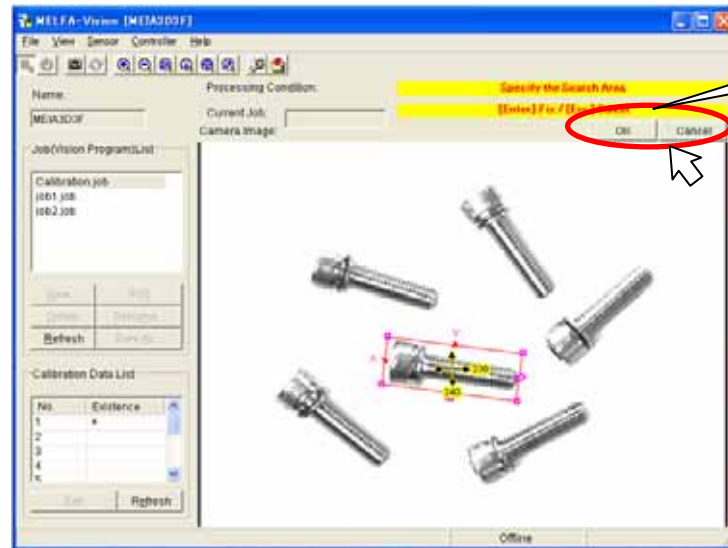

The [O.K.] button and [Cancel] button

(4-3) This specifies the work coordinates sent to the robot.

When you click the "Output position setting" [Image] button, the focus shifts to the main screen and a red circle is displayed at [Camera Image] on the main screen. Move this circle with the mouse or keyboard to specify what position to send to the robot for the registered work. If you use the keyboard, fine adjustments can be made with the [arrow keys]. To finalize the setting, press the [OK] key; to cancel it, press the [Cancel] key. The focus returns to the "Job Editing" screen.

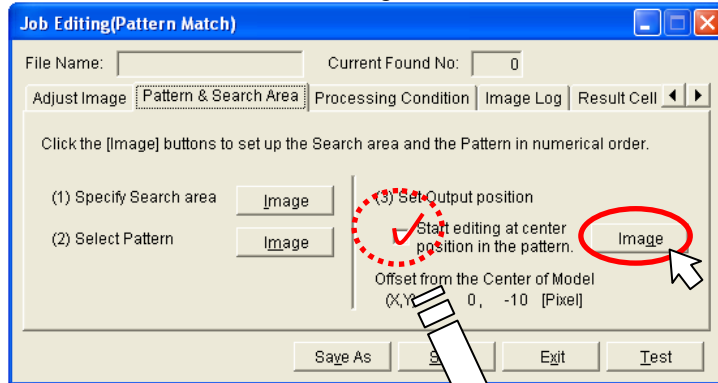

**Use the following steps when using MELFA-Vision earlier than Ver. 1.2.**

"Display mark at center of pattern" does not appear. Designate the area position mark of the pattern to be transmitted.

**Only when using MELFA-Vision Ver. 1.2 or later.**

If "Display mark at center of pattern" is checked, the pattern position area mark decided in step (4-2) will automatically appear.

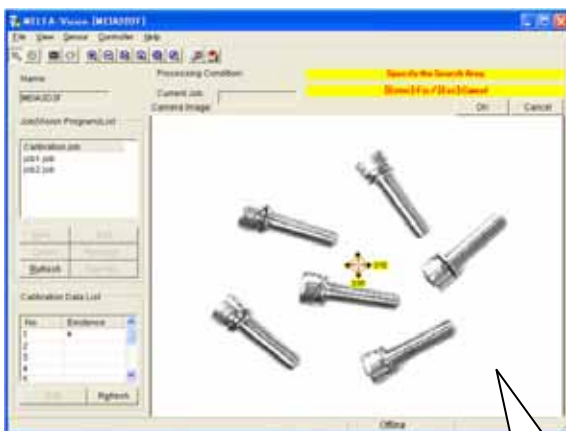

Camera picture

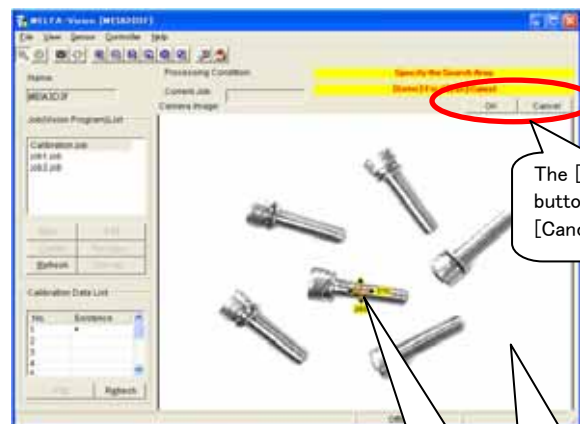

The [O.K.] button and [Cancel] button

Camera picture

The center of red O is a coordinates output position.

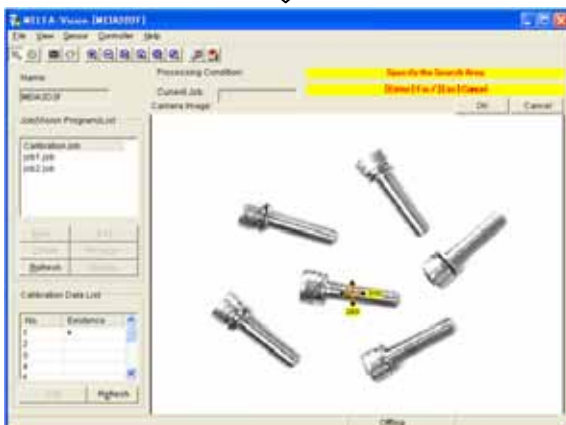

- (5) This determines the recognition conditions. When you click the "Job Editing" screen [Processing Condition] tab, the conditions for searching for the registered work are set.

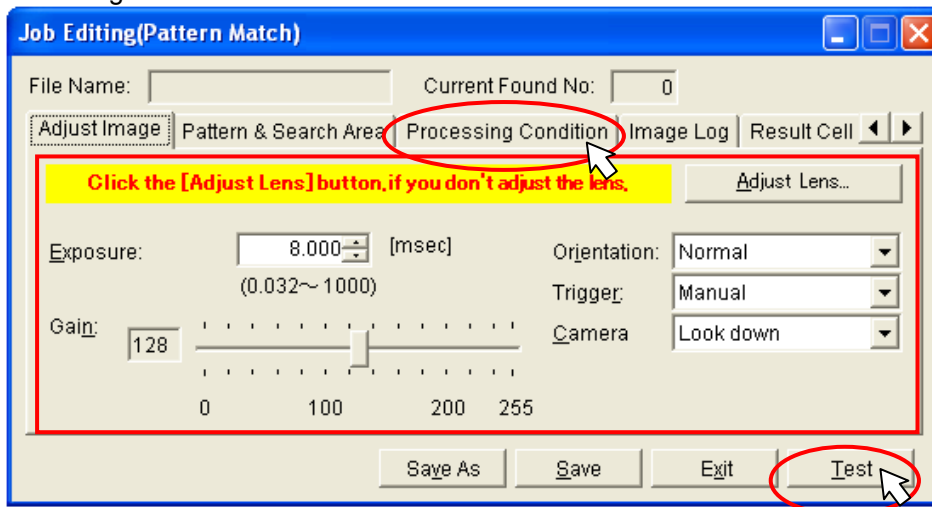

When you change a displayed setting item, then click the [Test] button, the results of image processing under the specified conditions are displayed at the main screen [Camera Image], so check whether or not the work is correctly recognized. For details on the setting items, see below.

**Table 6-7 List of [Processing Condition] Tab Items**

Setting item		Setting range	Explanation
Number to Find		1 - 255	This sets the maximum number of pieces that can be detected in one image processing.
Accept		1 - 100	This sets how much the detected work must match the registered work in order to be recognized. For the vision sensor, the degree of matching of the detected work is expressed as 1-100%. Work whose degree of matching is lower than the value set here is not recognized.
Find Tolerances	Angle Start	-180 - 180	Sets the detected work tilt (start angle – end angle). This sets the start angle and end angle with the angle for the registered work as 0°.
	Angle End	-180 - 180	
Sort By		None X Y	Returns the recognized work results in the specified sort order. When "None" is specified, the results are returned with the work sorted in order of high recognition ratio. This sorting is used for cases such as when multiple work pieces are detected and you want to grasp the work in order from left to right in the image. The "X" and "Y" specified here indicate the "X" and "Y" at the red frame displayed with the search area setting.
Offset of Rotation		-180 - 180	When outputting the recognized work results, this function adds the specified offset amount to the detection angle. When registering patterns, this is used if the 0°-tilt image can not be captured.
Calibration No.		None 1 - 10	This selects the data when outputting the recognized work coordinate value converted to the robot coordinate value. Work information can be converted to the coordinate systems for up to three robots and sent. Therefore, it is possible to select calibration numbers for three robots. * The figure above shows a screen assuming a system with one robot. When a system is selected with three robots, [Robot 2:] and [Robot 3:] display appears.

\* For all the items, if a value outside the range is input, it is replaced with the upper or lower limit value near the image going out of focus.

(5-1) This shows setting examples for the maximum detection count.

◆ When 10 is set

Number to Find:  (1~255)

When you click the "Job Editing" screen [Test] button, the 6 pieces of work captured in the image are recognized and they are displayed with "+" pointer mark and a number from 0 in order of highest degree of match attached to each piece of work.

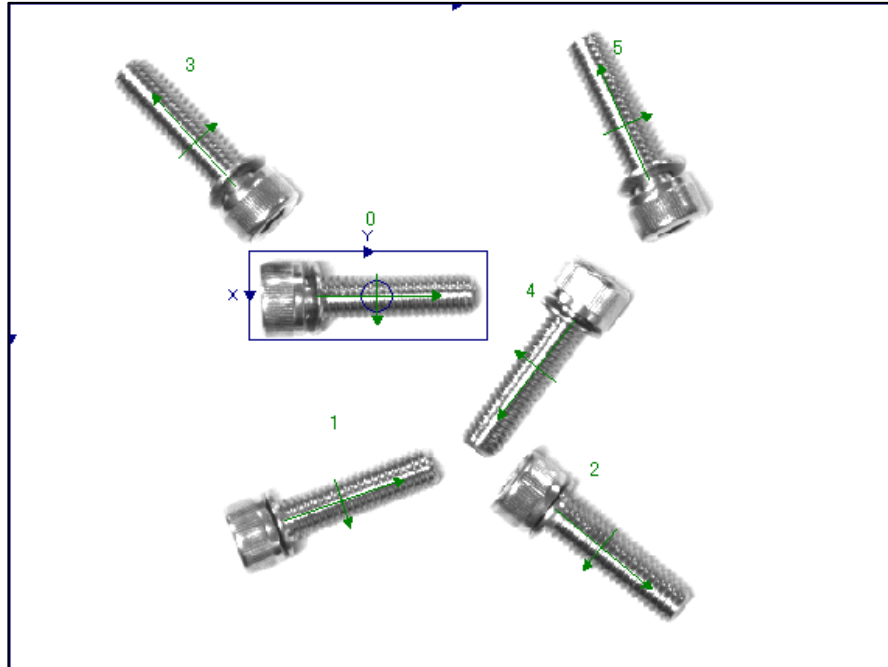

◆ When 3 is set

Number to Find:  (1~255)

When you click the "Job Editing" screen [Test] button, the three pieces of work with the highest degree of match are detected. They are displayed with "+" pointer mark and a number from 0 to 2 in order of highest degree of match attached to each piece of work.

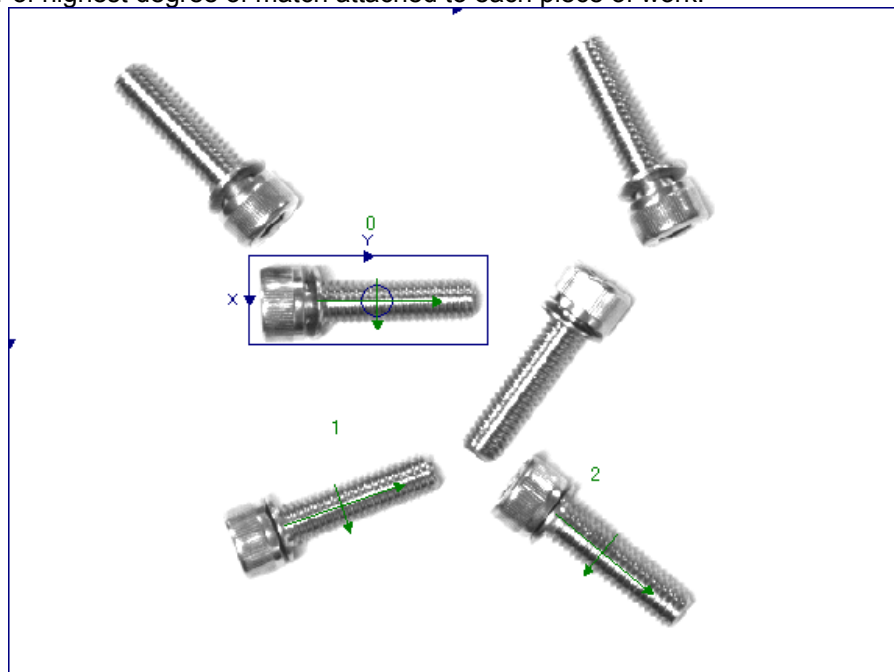

(5-2) This shows setting examples for the threshold.  
The higher the threshold, the greater the precision of the detection.  
◆ When 40% is set as the threshold

Maximum detection count of 10: Number to Find:  (1~255)

Threshold of 40%:

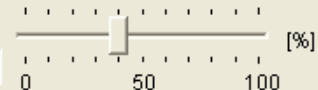
Accept:   [%]

When you click the "Job Editing" screen [Test] button, even though there is one piece of work at the top left, two pieces of work are recognized. Large work is also recognized and the recognition count becomes 7.

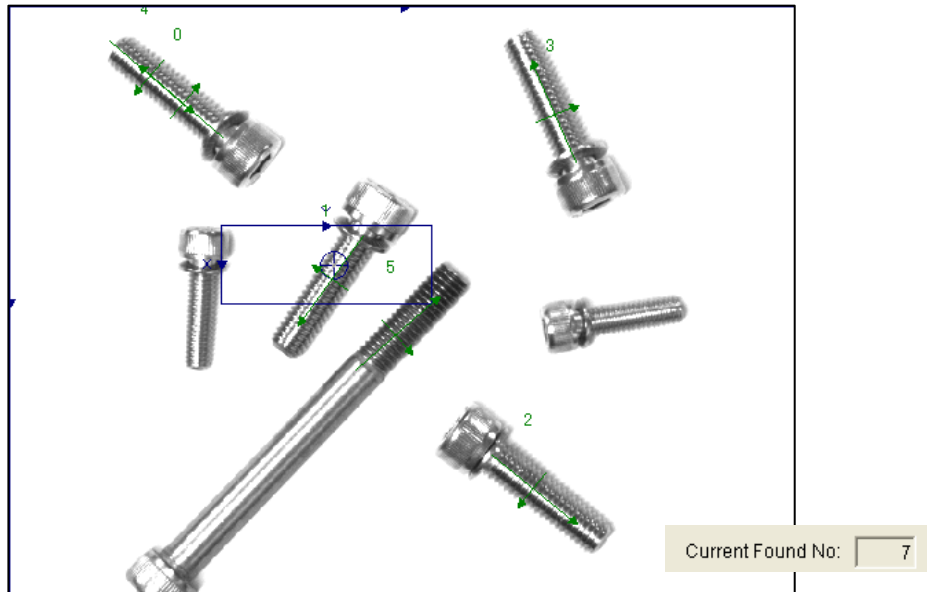

◆ When 60% is set as the threshold

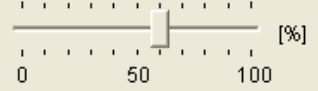
Accept:   [%]

When you click the "Job Editing" screen [Test] button, only the registered four pieces of work are recognized, which is correct.

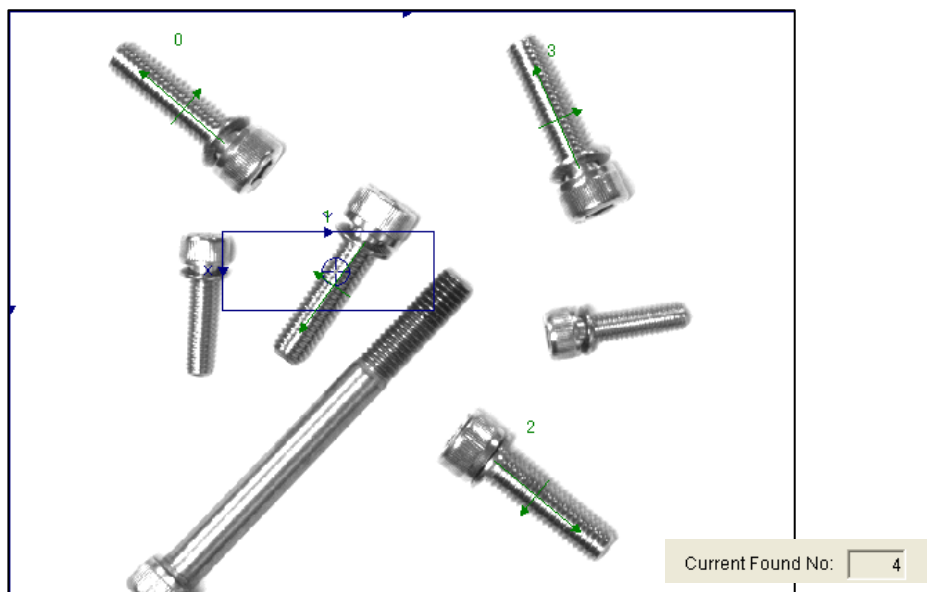

(5-3) This shows setting examples for the start angle and end angle.

◆ When Start angle:  $-45^\circ$ , end angle:  $45^\circ$  is set

Find Tolerances:

Angle Start:	<input type="text" value="-45"/>	[degrees]
Angle End:	<input type="text" value="45"/>	[degrees]

(-180~180)

When you click the "Job Editing" screen [Test] button, only work is detected that is within the  $\pm 45^\circ$  range with the registered work angle as  $0^\circ$ .

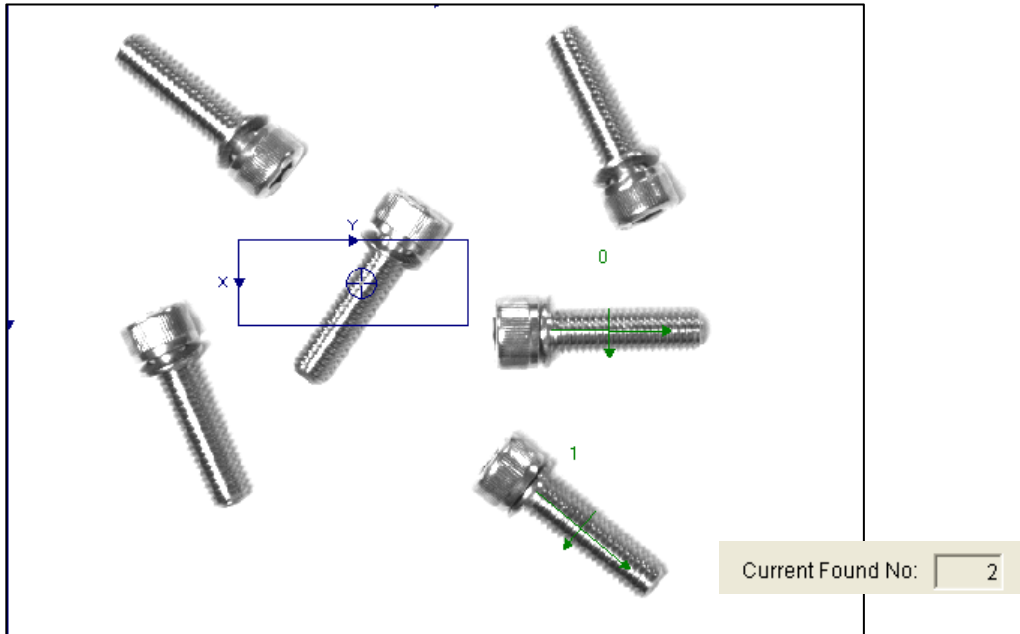

◆ When Start angle:  $-45^\circ$ , end angle:  $180^\circ$  is set

Find Tolerances:

Angle Start:	<input type="text" value="-45"/>	[degrees]
Angle End:	<input type="text" value="180"/>	[degrees]

(-180~180)

When you click the "Job Editing" screen [Test] button, only work is detected that is within the range  $-45^\circ$  to  $+180^\circ$  with the registered work angle as  $0^\circ$ .

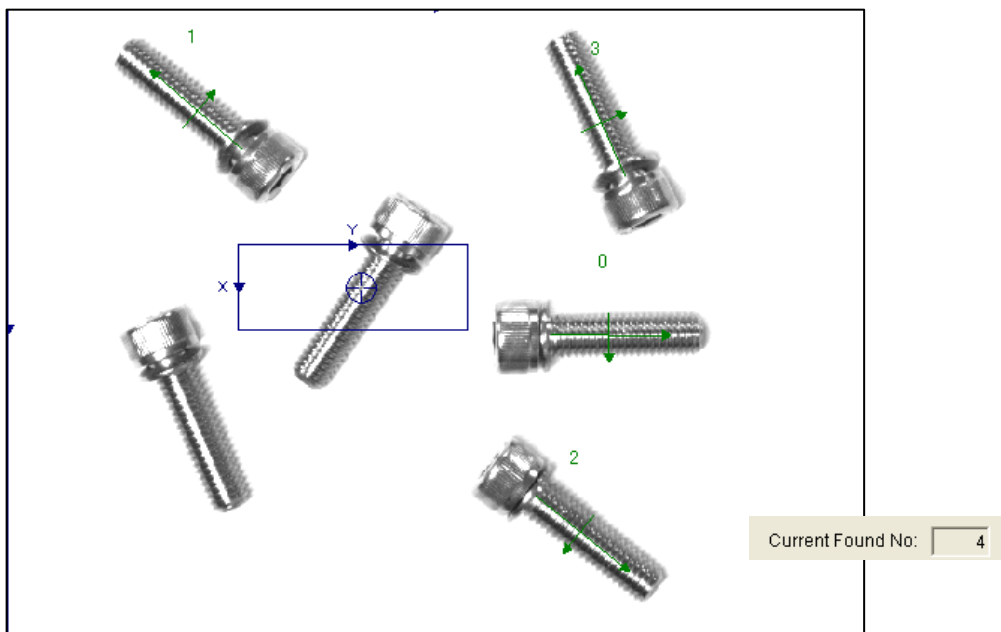



(5-4) This shows setting examples for the sort direction.

◆ Sort direction: X



When you click the "Job Editing" screen [Test] button, the recognized work is displayed with a number from 0 in order of the +X direction (from top to bottom in the figure above) of the frame specified with the search area specification.

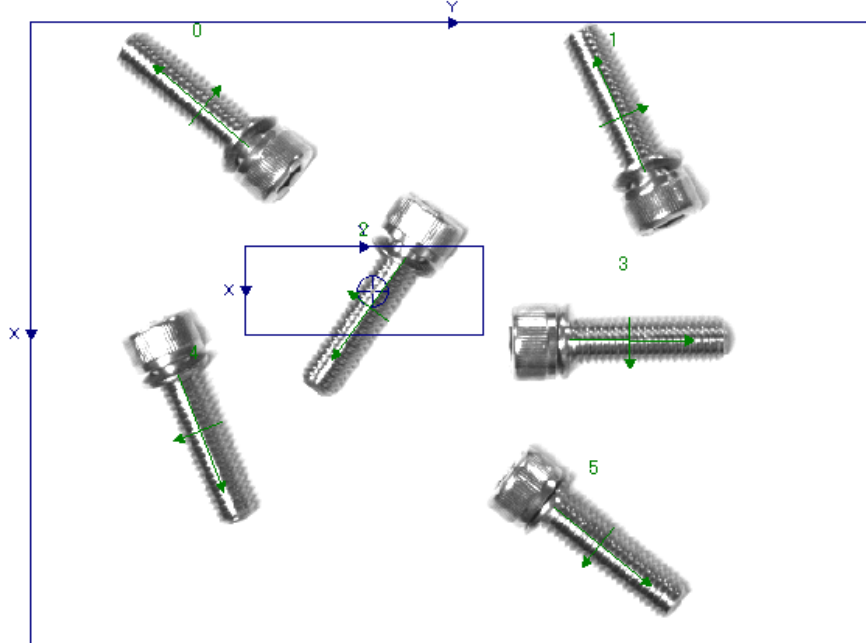

◆ Sort direction: Y



When you click the "Job Editing" screen [Test] button, the recognized work is displayed with a number from 0 in order of the +Y direction (from left to right in the figure above) of the frame specified with the search area specification.

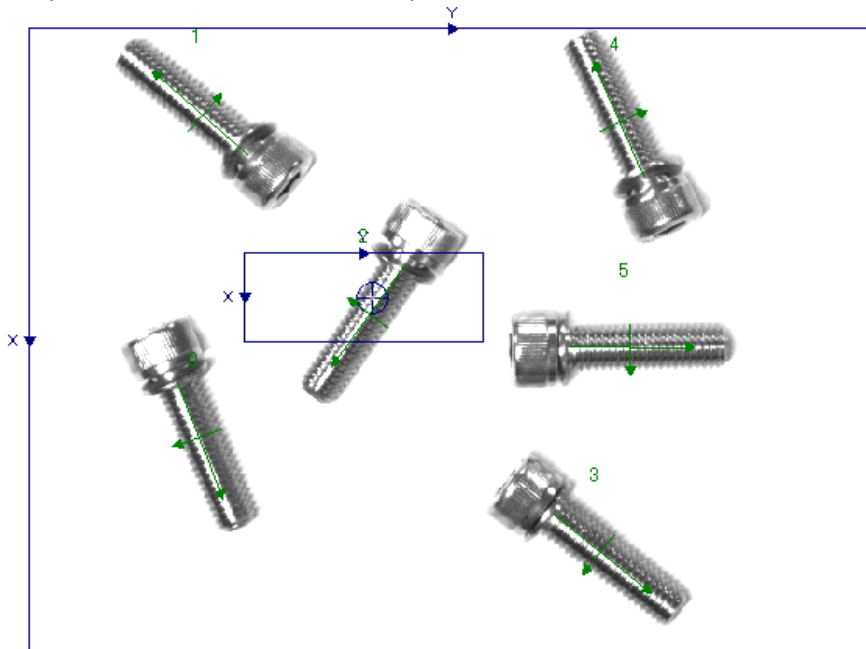



- (6) The "Job Editing" screen [Image log] tab is explained in "9.2.2 Job Editing screen ([Image Log] tab)"; the [Results Cell Position] tab is explained in "9.2.3 Job edit screen ([Result Cell Position] tab)".
- (7) When you want to check not only the image but also the numeric data in the image processing results, click [Sensor] – [Display Test Result(s)] in the main screen menu.

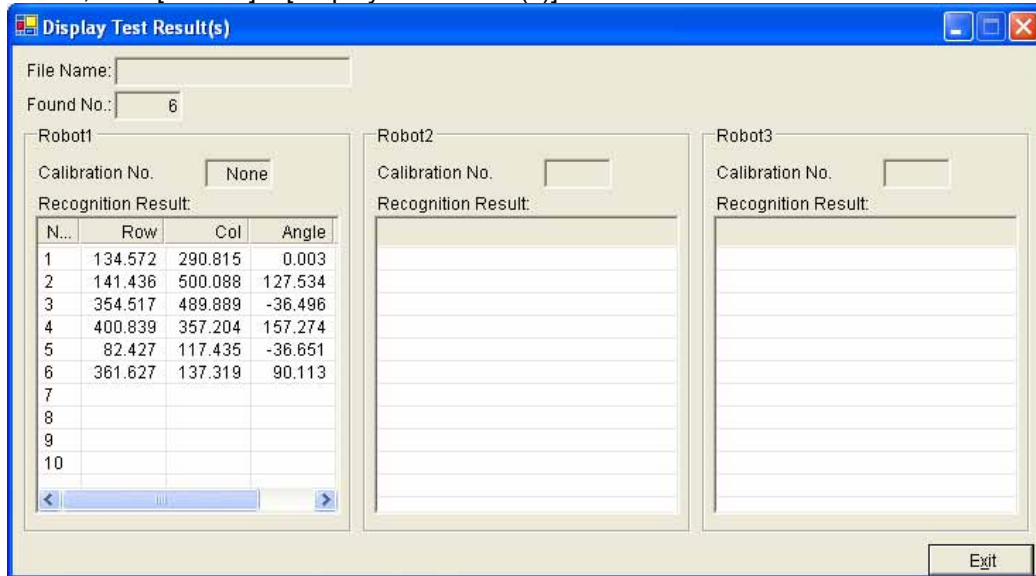

In the initial display, recognition results monitors for three robots are displayed.

To view just the results for [Robot 1], move the mouse pointer to the right edge of the screen and while dragging the screen right edge, move the mouse to the left.

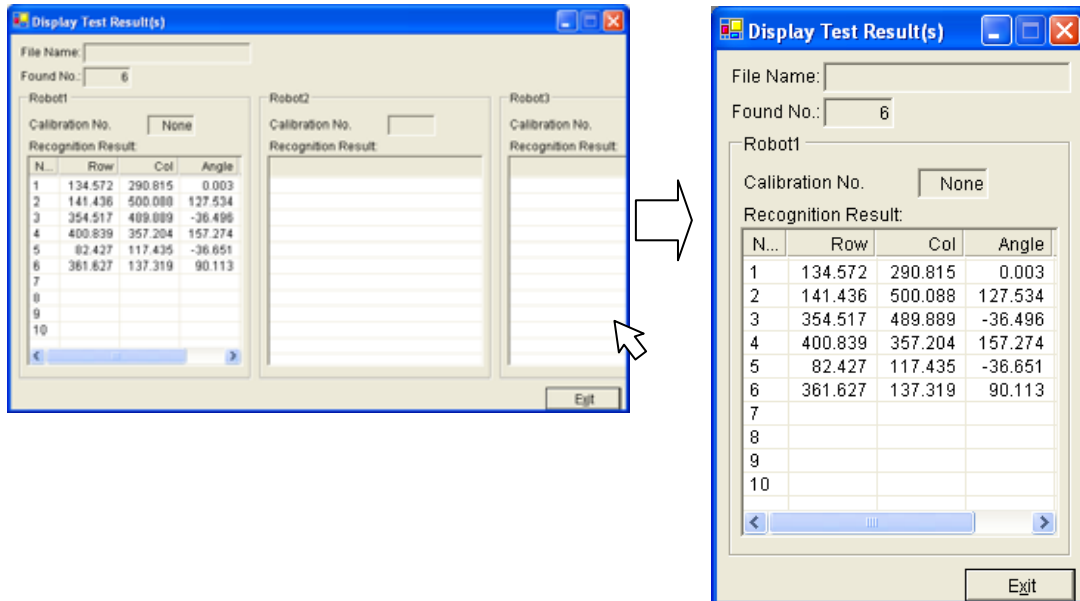

- (8) If the recognition results are not what was expected, change the recognition conditions with the "Job Editing" screen [Processing Condition].
- (9) If the recognition results are what was expected, click the "Job Editing" screen [Save] button to save the image processing conditions set up till now to the vision sensor. When you click the [Save] button, a "Confirmation" screen is displayed to check that you want to save the settings. If you click [No], the save is cancelled. If you click [Yes], the "Input the File Name" screen is displayed, so input the desired vision program name, then click the [OK] button. You can check that the file was saved with the "Job Editing" screen "File Name" or the main screen "Current Job", or the "Job (Vision Program) List".

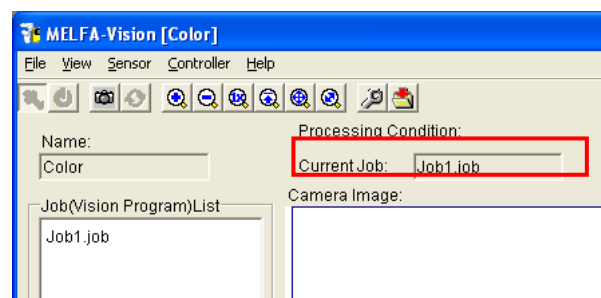
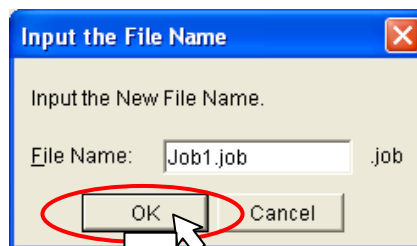
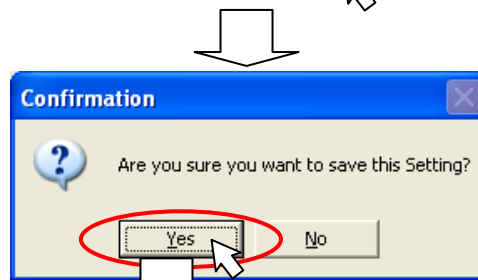
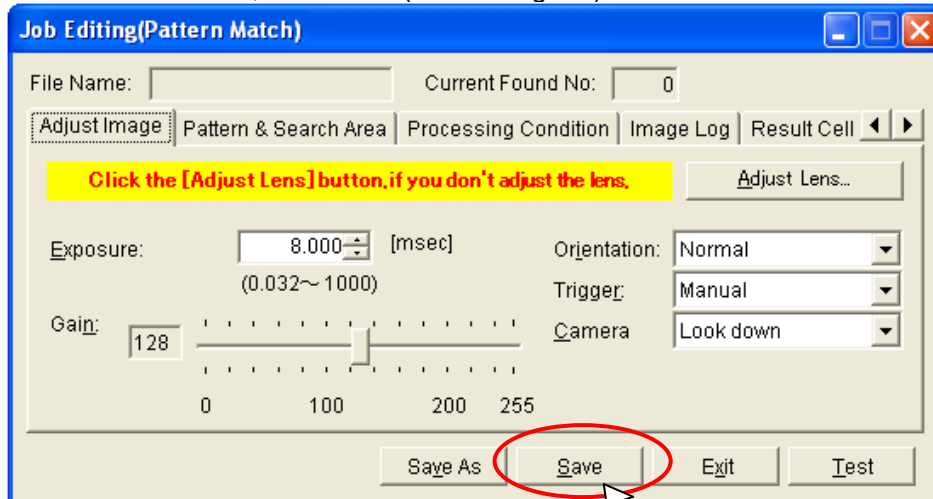

- (10) Click the "Job Editing" screen [Close] button to close the "Job Editing" screen.

(11) Job1.job を別名で保存したい場合は、Job1.job を選択し「別名保存」をクリックしてください。

(Ex.) Here, job1 is saved to job2.

The contents of the same vision program are saved by another name.

The contents of a program, such as a front reverse side judging which used the same work, can be saved by the alias.

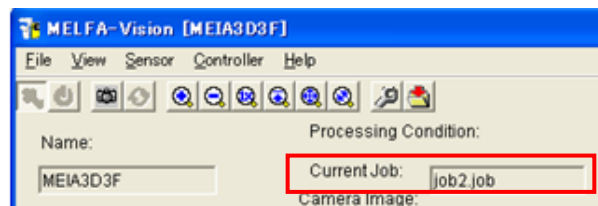
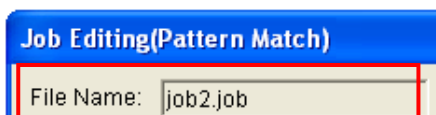
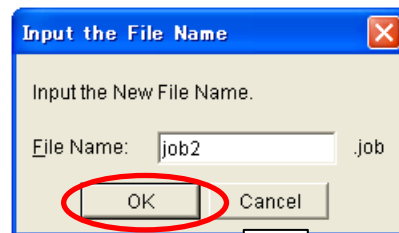
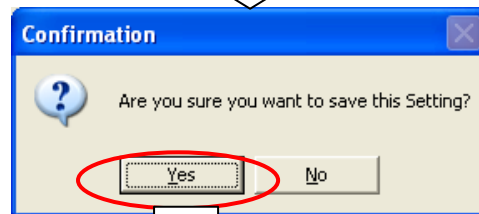
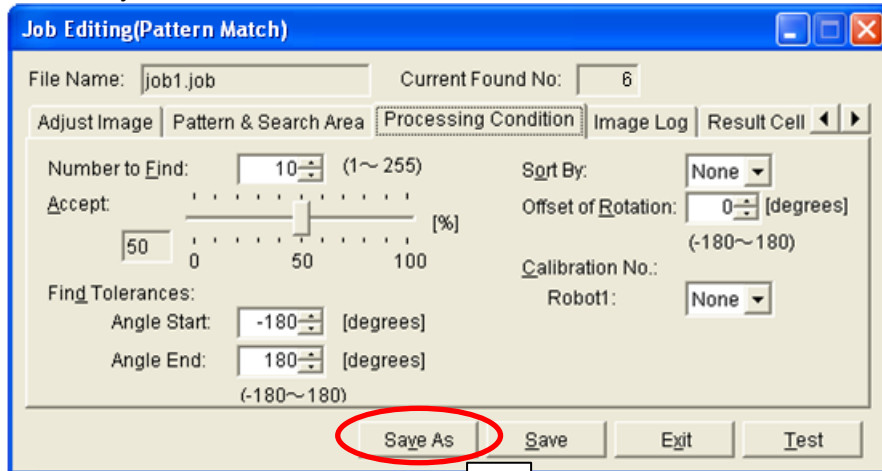

# 7. Robot Controller Settings

This chapter explains the items set in the robot controller, using a system with one vision sensor and one robot controller as an example.

## 7. 1. Robot Controller Parameter Settings

In order for the robot controller to control the vision sensor, it is necessary to set the parameters for the communication connection with the vision sensor. This section explains the methods for setting the parameters.

- (1) Switch On the robot controller power.



- (2) Set the robot controller IP address.

- ① With the teaching box (R28TB), turn the key switch in the "Enable" direction.
- ② [MENU] – [5: Maintenance] – [1: Parameters] – Input "NETIP"– [INP]–Input the IP address.
- ③ Switch Off the robot controller power, then switch it On again.

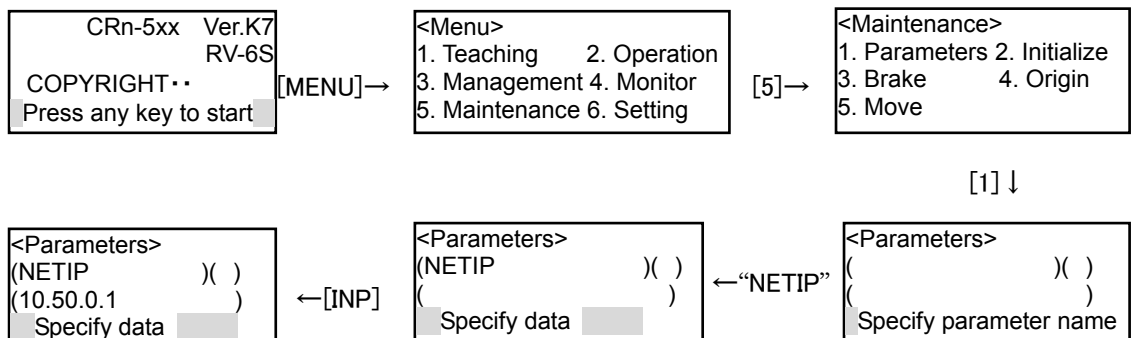

- (3) From the Windows Start menu, click [All Programs] – [MELSOFT Application] – [RT ToolBox] – [MELFA-Vision] to start "MELFA-Vision".

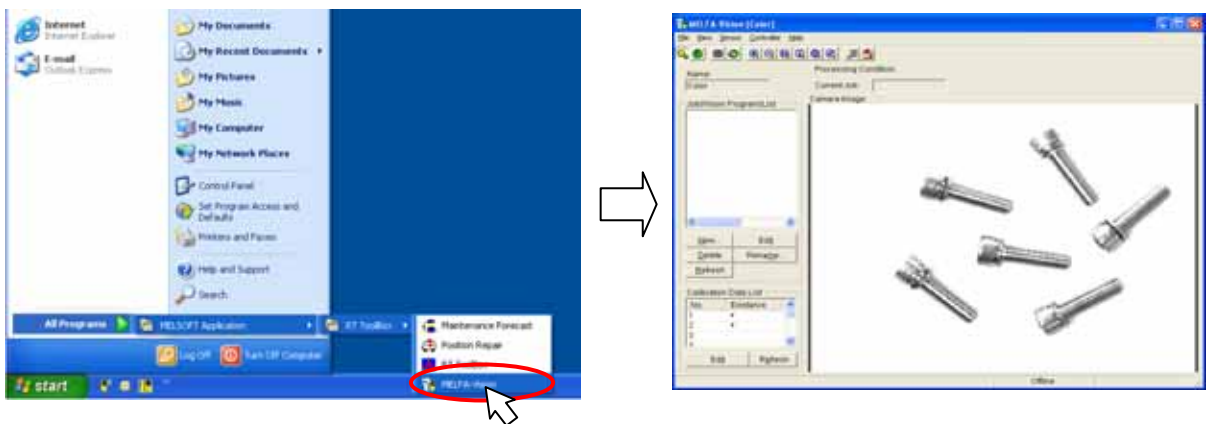

(4) This makes the settings for the robot controller and MELFA-Vision to communicate.

Click the "Communications server"  displayed on the Windows taskbar to display the "Communication Server" screen. (If the communication parameters have not been set yet, all the information is written in red.)

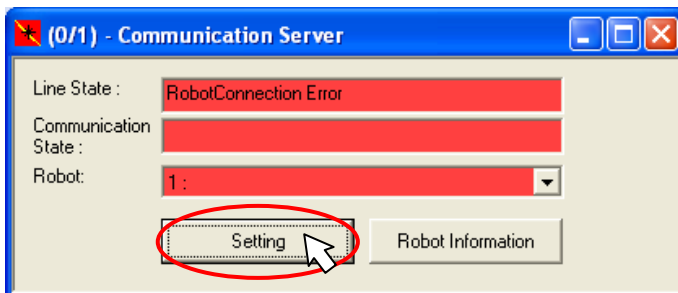

Click the [Setting] button to display the "Communication Setting" screen.

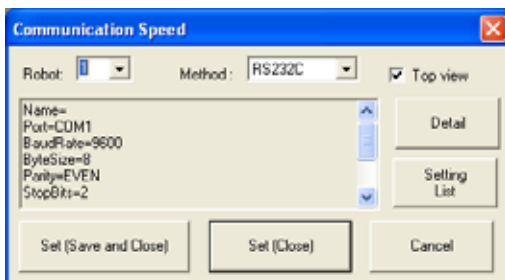

Click [Method], then select "TCP/IP".

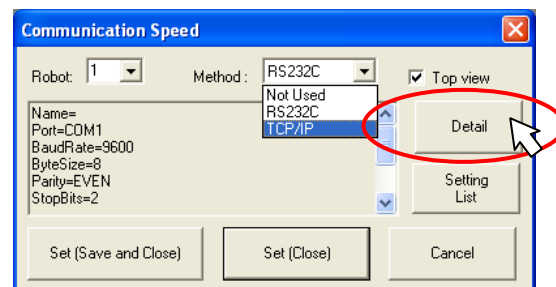

Click the [Detail] button to display the "TCP/IP Communication Protocol" screen.

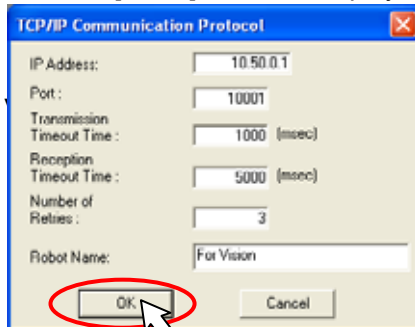

IP Address : Robot controller IP address.

Robot Name : Easy-to-understand name (Here, [For

Click the [OK] button to finalize the settings.

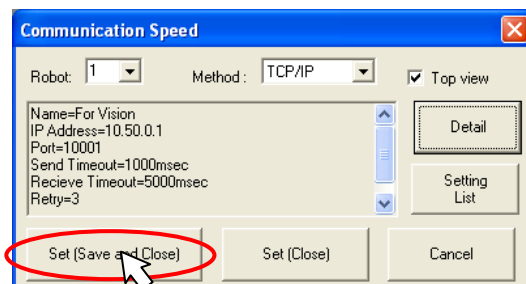

Click the [Set(Save and Close)] button to store the communication settings you have set.

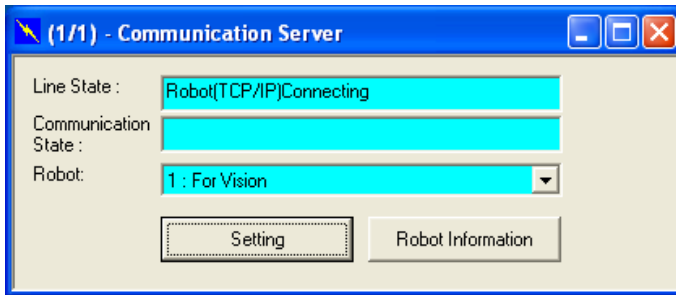

Check that all the frames on the "Communication Server" main screen become light blue. If a frame is green, redo the setting.

- (5) This sets the parameters for the robot controller and vision sensor to communicate. From MELFA-Vision menu, select [Controller] – [Communication Setting] to display the "Communication Setting" screen.

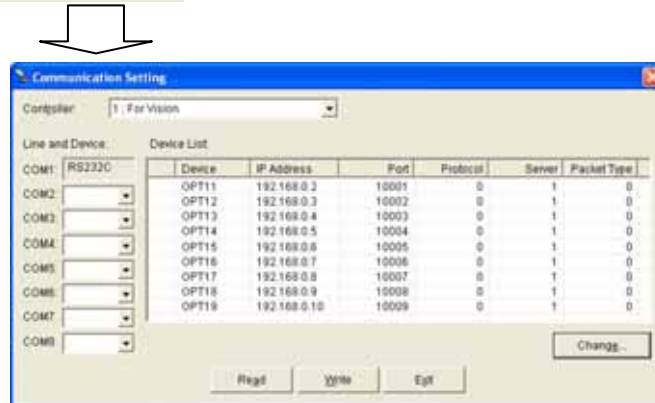
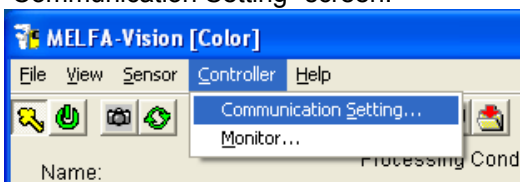

This sets the device number for the COM number used. Here is an example in which a COM number of "COM2:" is used and the setting content is "OPT15". Click the "COM2" pull-down, then select "OPT15".

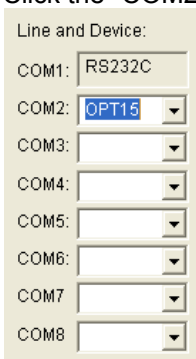

From the "Device List", select [OPT15], then click the [Change] button.

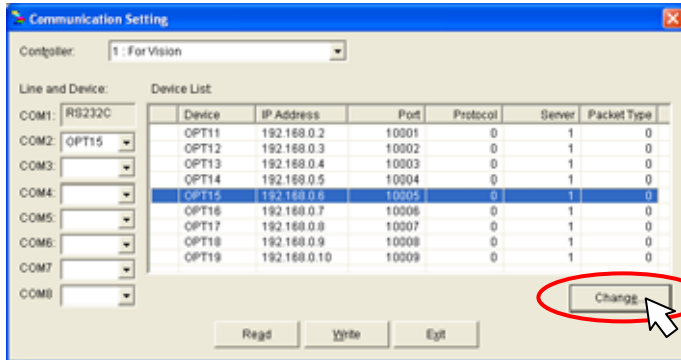

On the displayed "Device Setting" screen, switch On the [Change the Parameter to connect Vision] checkbox, then input the vision sensor IP address as the IP Address.

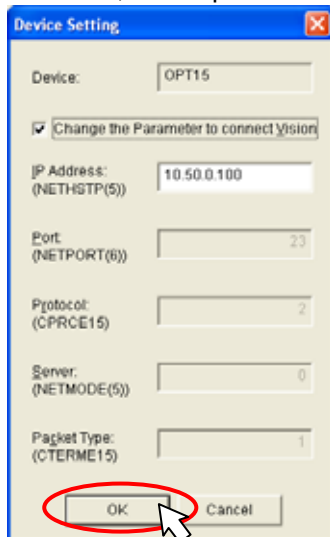

Click the [OK] button and check that a "\*" is displayed in the "Communication Setting" screen "Device List".

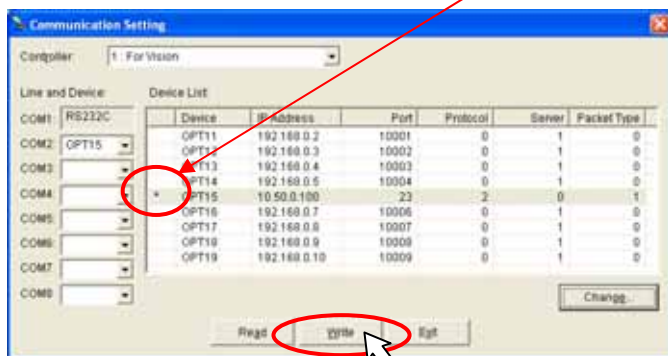

Click the [Write] button to display the "Confirmation" screen.

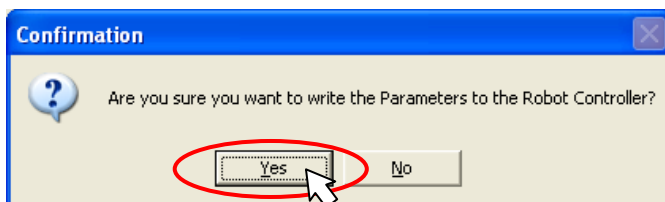

## 7 Robot Controller Settings

If you click [Yes], the parameters are written to the robot controller. A message is displayed that the controller power will be switched Off, then On again to put the parameter change into effect.

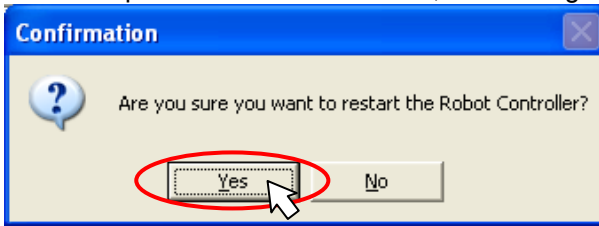

Click the [Yes] button and wait for the robot controller power supply to be reset. When the robot controller starts, click the [Read] button on the "Communication Setting" to check if the parameters have been written normally.

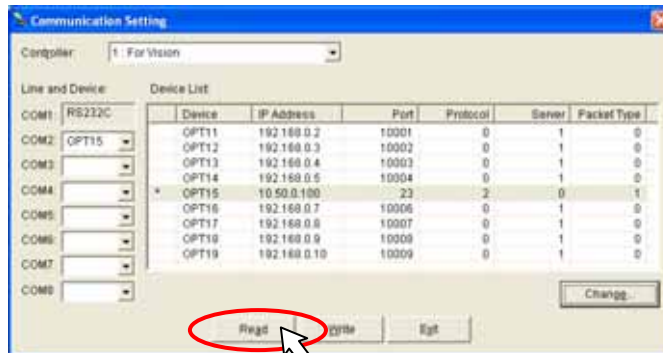

If the parameters were written normally, click the [Exit] button to close the "Communication Setting" screen.

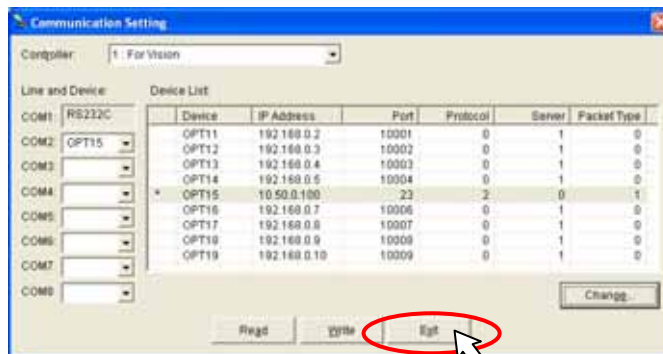



## 7.2. Calibration Setting

Calibration is a function that converts the vision sensor coordinate system into the robot coordinate system. This calibration work is necessary for recognizing what position in the robot coordinate system the recognized work is at. If this setting is not made, the coordinates for work recognized by the vision sensor display the results in the sensor coordinate system.



This section explains calibration work using MELFA-Vision.

- (1) Prepare the equipment used in calibration work.

Prepare four marking labels (copy the marking sheet in the appendix, align it with the image field of vision and make enlarged and reduced copies) and the calibration jigs (for example a hand with sharpened tip for specifying the center of the marking label with the robot).

- (2) Set MELFA-Vision to a live image.

From the MELFA-Vision menu, click [Sensor] – [Live Mode] or from the MELFA-Vision tool bar,

click  to put MELFA-Vision into live image mode. Check that  sinks.

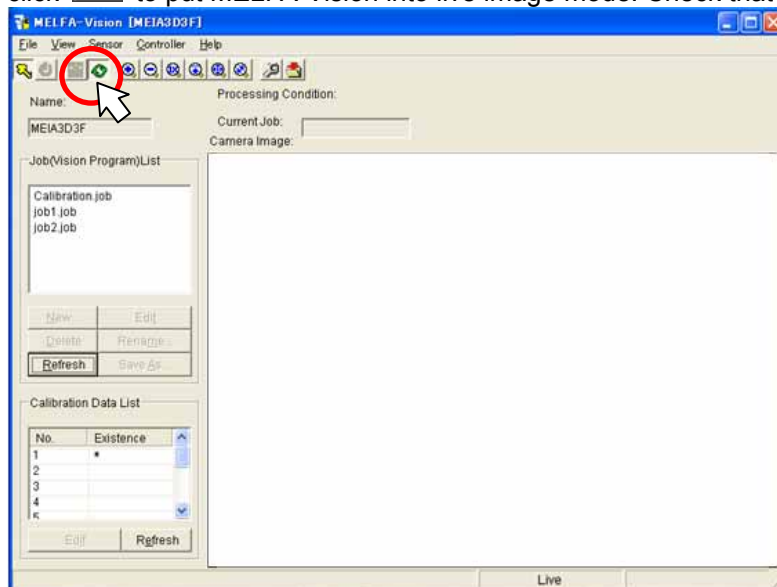

- (3) Adjust the mark positions so that four marking labels for calibration fit in the screen. Here is an example in the appendix marking sheet is placed. Here, the four marks are set to be marks 1-4 as in the figure below.

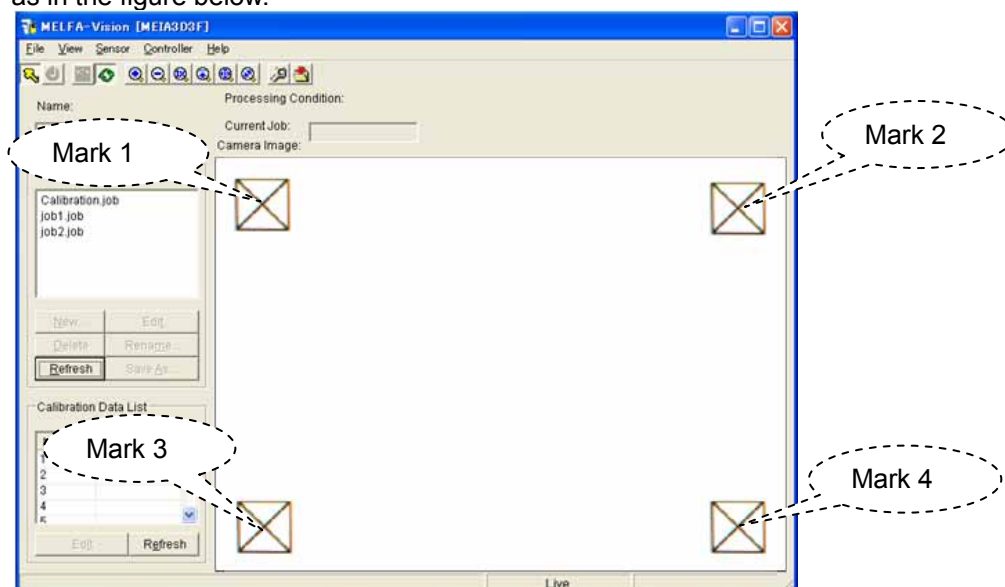

- (4) Exit the live image.  
From the MELFA-Vision menu, click [Sensor] – [Live Mode] or from the MELFA-Vision tool bar, click  to exit live image mode.
- (5) From the MELFA-Vision main screen, select [No. 1] in the [Calibration Data List]. This section explains [No. 1] data creation.

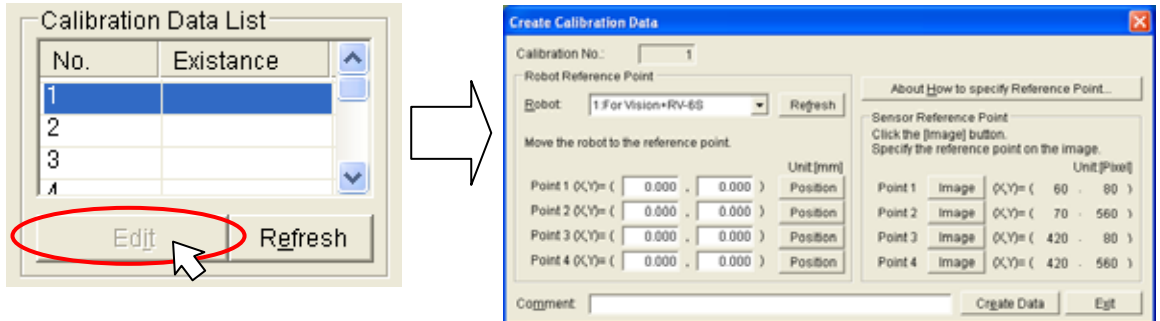

- (6) On the "Create Calibration Data" screen, click the [About How to specify Reference Point] button to check the calibration operation method.

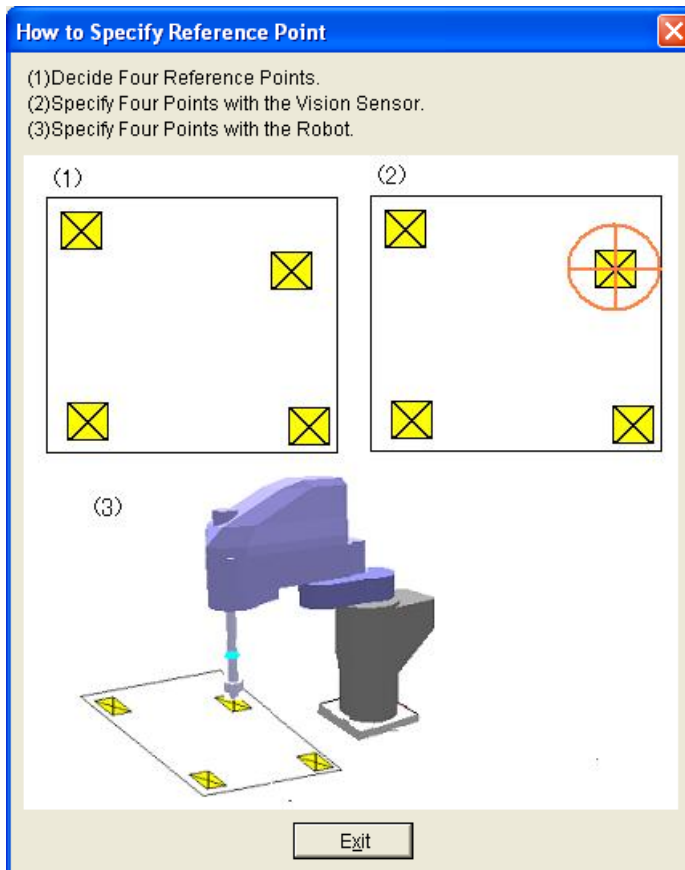

- (7) Specify the first point on the vision sensor.  
Click the [Image] button for the first point.

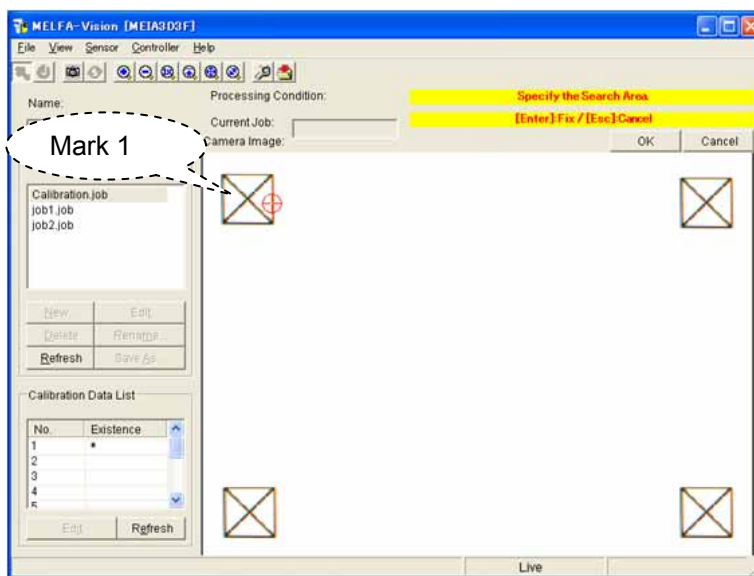
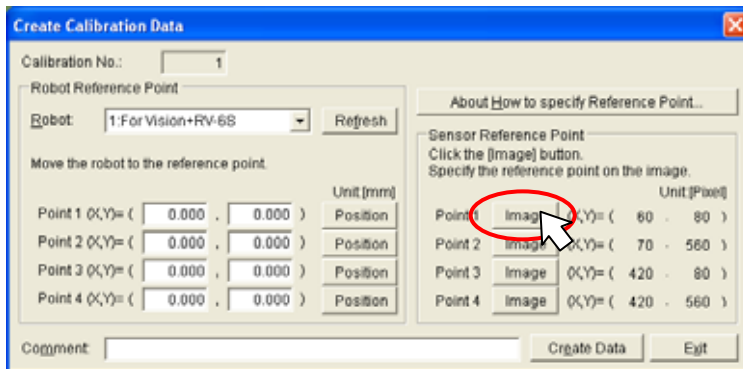

Use the mouse or the [arrow keys] to move the  mark to mark 1, then click the [OK.] button.

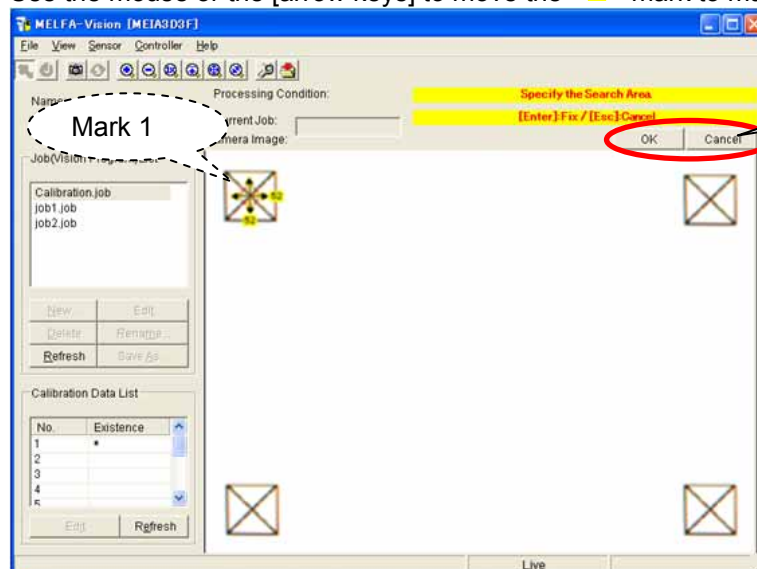

- (8) Specify the second point on the vision sensor.  
Click the [Image] button for the second point.

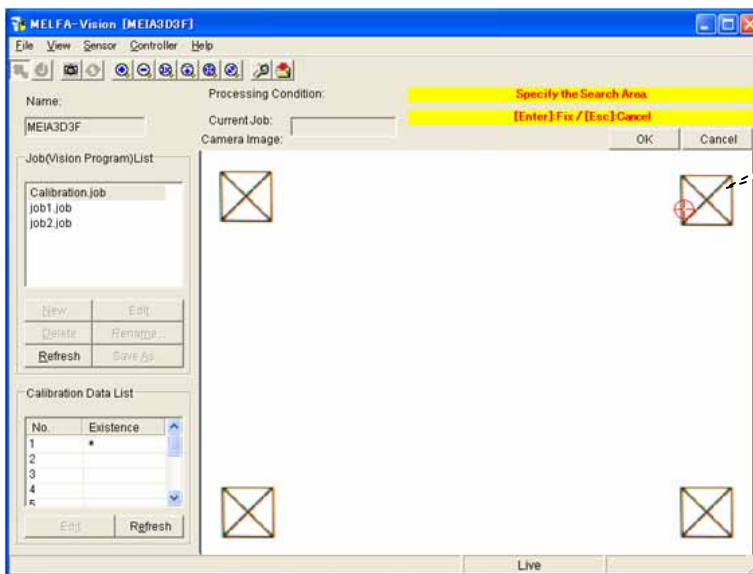
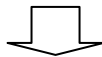
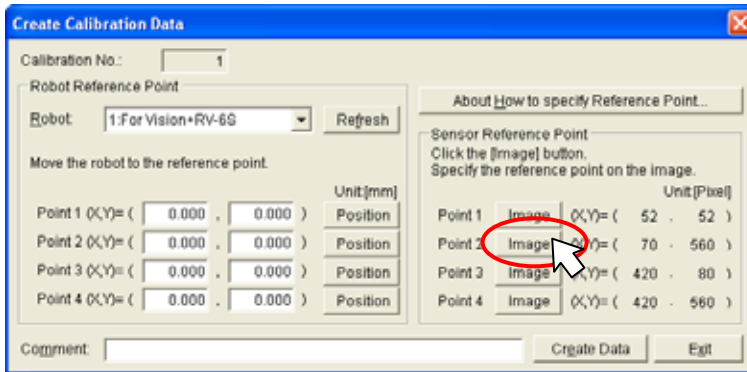

Use the mouse or the [arrow keys] to move the  mark to mark 2, then click the [OK.] button.

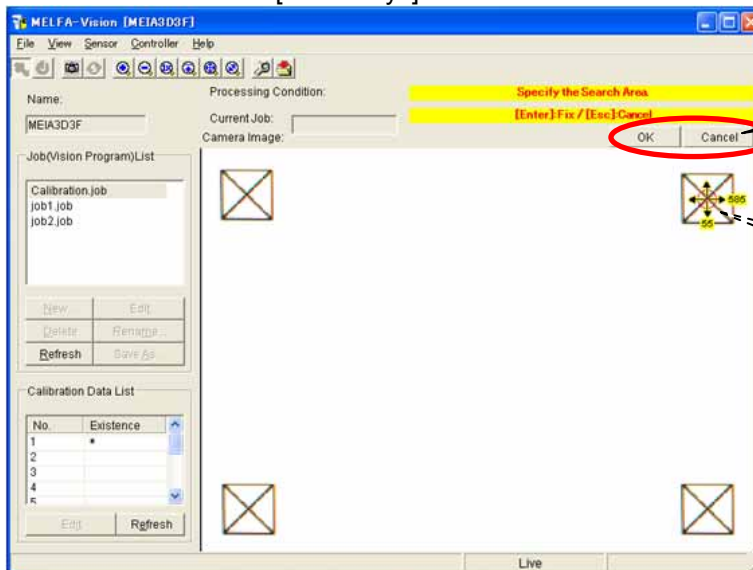

- (9) Specify the third point on the vision sensor.  
Click the [Image] button for the third point.

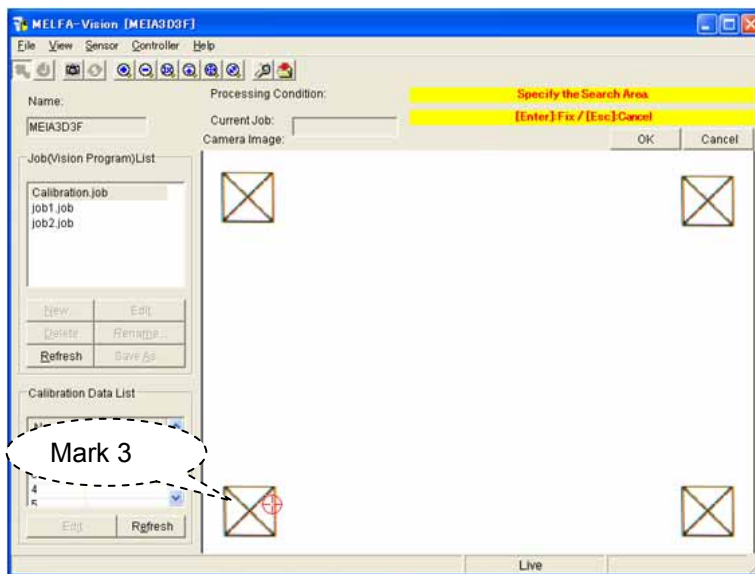
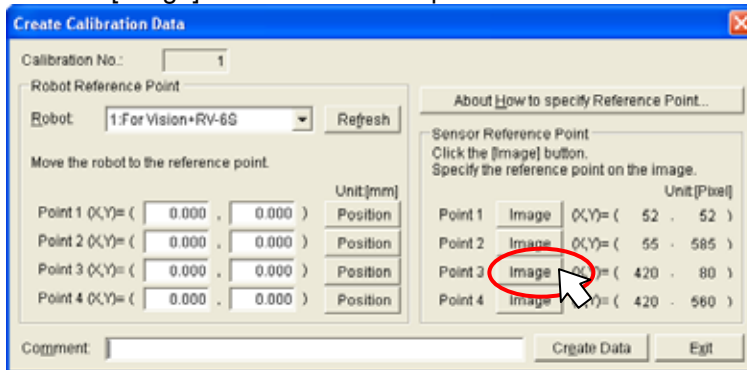

Use the mouse or the [arrow keys] to move the  mark to mark 3, then click the [OK.] button.

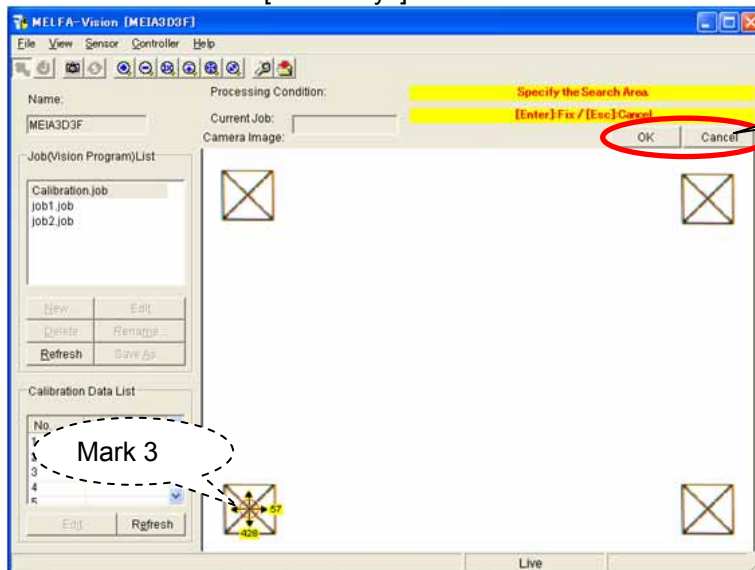

- (10) Specify the fourth point on the vision sensor.  
Click the [Image] button for the fourth point.

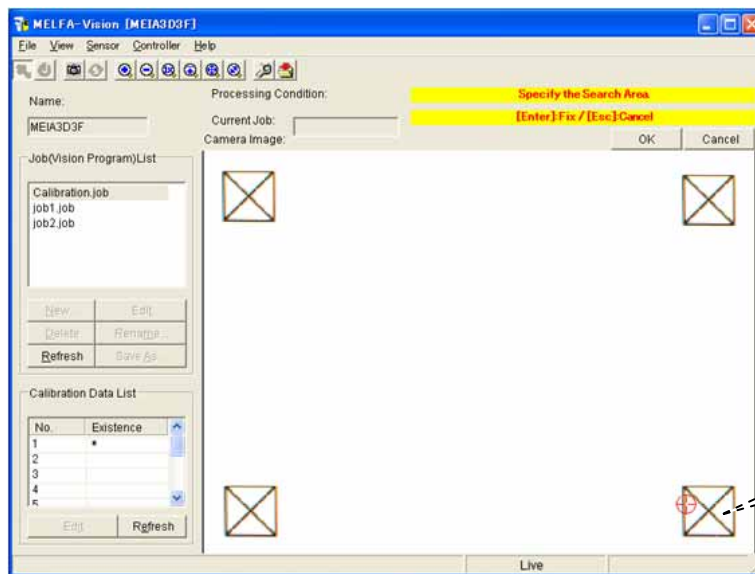
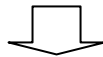
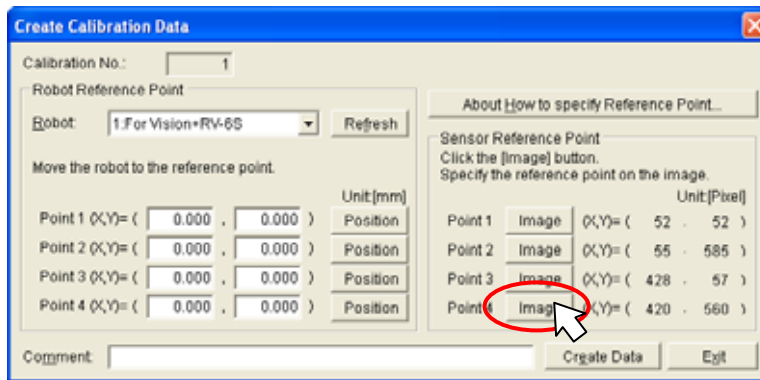

Mark 4

Use the mouse or the [arrow keys] to move the  mark to mark 4, then click the [OK.] button.

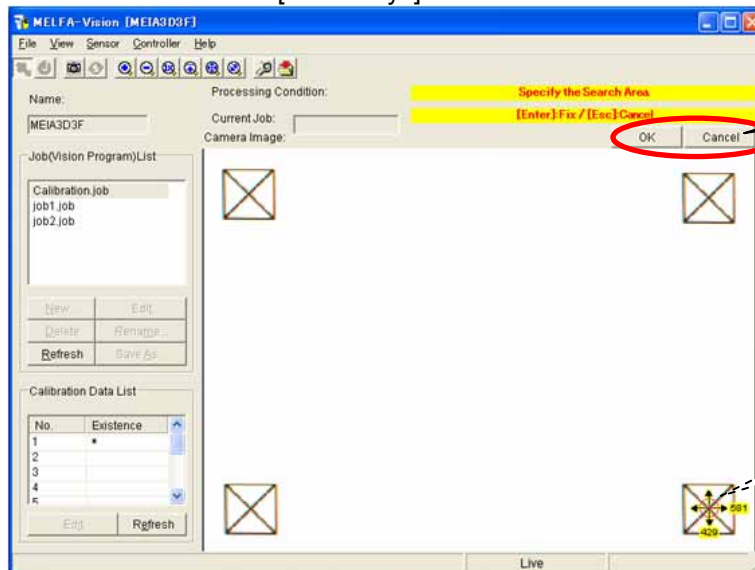

The [OK.] button and [Cancel] button .

Mark 4

(11) Specify the first point with the robot.

Use the teaching box to move the robot hand to the first point.

**\* For this work, the use of a pointed-tip object in the hand is recommended.**

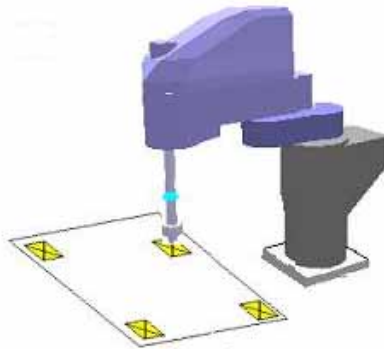

On the "Create Calibration Data" screen, click the [Position] button for the first point to acquire the robot's current position.

Robot Reference Point		About How to specify Reference Point...	
Robot: 1 For Vision+RV-6S Refresh		Sensor Reference Point	
Move the robot to the reference point.		Click the [Image] button.	
		Specify the reference point on the image.	
Point 1	X(Y)= ( 312.414 , 109.209 )	Point 1	Image X(Y)= ( 52 , 52 )
Point 2	X(Y)= ( 0.000 , 0.000 )	Point 2	Image X(Y)= ( 55 , 585 )
Point 3	X(Y)= ( 0.000 , 0.000 )	Point 3	Image X(Y)= ( 428 , 57 )
Point 4	X(Y)= ( 0.000 , 0.000 )	Point 4	Image X(Y)= ( 429 , 581 )

(12) Specify the second point with the robot.

Use the teaching box to move the robot hand to the second point.

On the "Create Calibration Data" screen, click the [Position] button for the second point to acquire the robot's current position.

Robot Reference Point		About How to specify Reference Point...	
Robot: 1 For Vision+RV-6S Refresh		Sensor Reference Point	
Move the robot to the reference point.		Click the [Image] button.	
		Specify the reference point on the image.	
Point 1	X(Y)= ( 312.414 , 109.209 )	Point 1	Image X(Y)= ( 52 , 52 )
Point 2	X(Y)= ( 480.449 , 109.275 )	Point 2	Image X(Y)= ( 55 , 585 )
Point 3	X(Y)= ( 0.000 , 0.000 )	Point 3	Image X(Y)= ( 428 , 57 )
Point 4	X(Y)= ( 0.000 , 0.000 )	Point 4	Image X(Y)= ( 429 , 581 )

(13) Specify the third point with the robot.

Use the teaching box to move the robot hand to the third point.

On the "Create Calibration Data" screen, click the [Position] button for the third point to acquire the robot's current position.

Robot Reference Point		About How to specify Reference Point...	
Robot: 1 For Vision+RV-6S Refresh		Sensor Reference Point	
Move the robot to the reference point.		Click the [Image] button.	
		Specify the reference point on the image.	
Point 1	X(Y)= ( 312.414 , 109.209 )	Point 1	Image X(Y)= ( 52 , 52 )
Point 2	X(Y)= ( 480.449 , 109.275 )	Point 2	Image X(Y)= ( 55 , 585 )
Point 3	X(Y)= ( 313.651 , -144.682 )	Point 3	Image X(Y)= ( 428 , 57 )
Point 4	X(Y)= ( 0.000 , 0.000 )	Point 4	Image X(Y)= ( 429 , 581 )



- (14) Specify the fourth point with the robot.  
 Use the teaching box to move the robot hand to the fourth point.  
 On the "Create Calibration Data" screen, click the [Position] button for the fourth point to acquire the robot's current position.

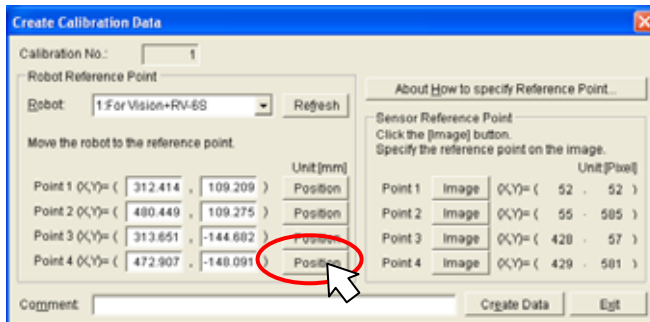

- (15) Input a comment.  
 In the "Create Calibration Data" screen [Comment] column input a comment to make the meaning of this work easy to understand, then click the [Create Data] button.

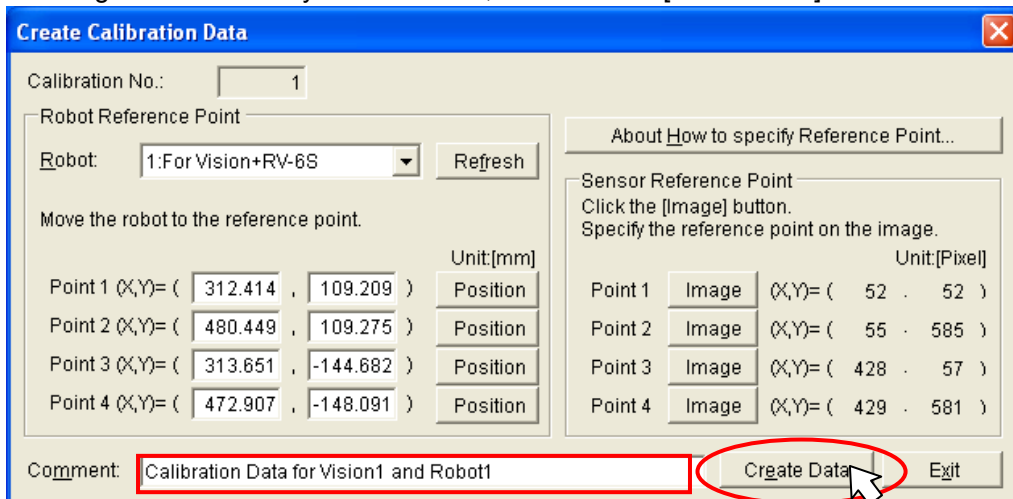

- (16) Check that the calibration data is created.  
 Check the MELFA-Vision main screen [Calibration Data List] column and check that there is an "\*" in the "No. 1" [Existance] column.

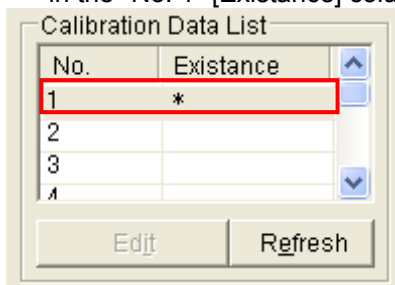

- (17) Close the "Create Calibration Data" screen.  
 Click the "Create Calibration Data" screen [Exit] button.



(18) The calibration data is set for the created job and the recognized work is displayed with the robot coordinate system.

From the MELFA-Vision main screen "Job(Vision Program)List", select "Job1.job", then click the [Edit] button.

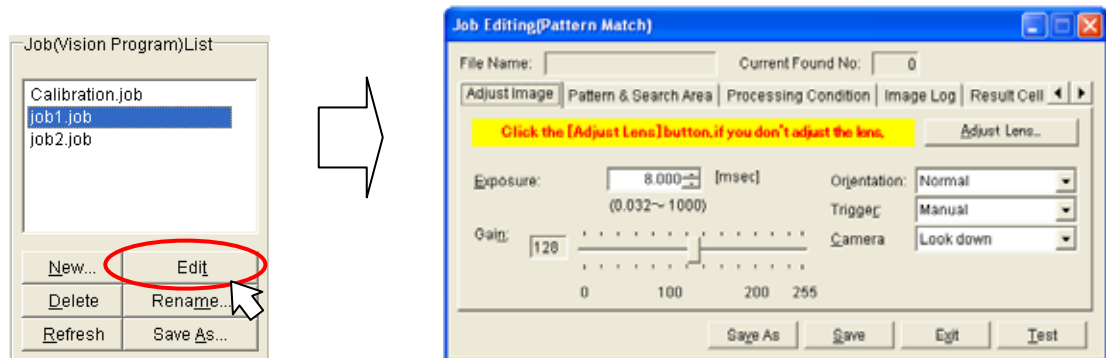

On the displayed "Job Editing" screen, click the [Processing Conditions] tab.

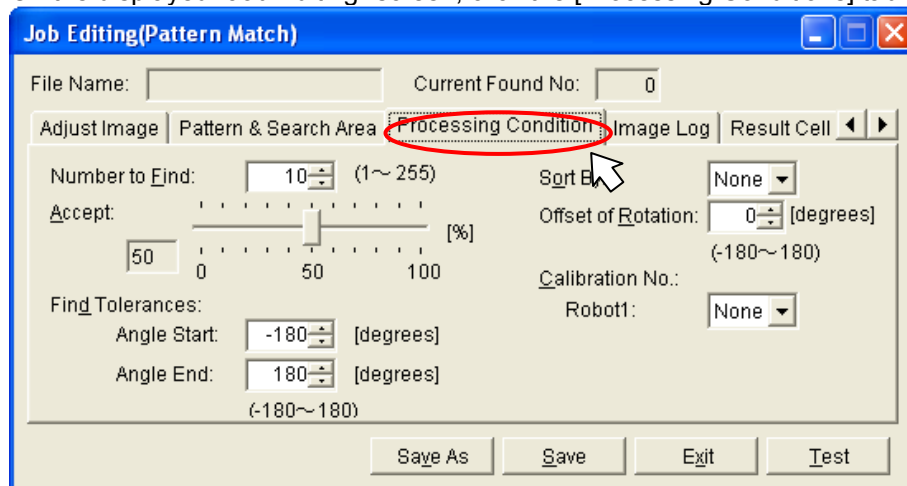

Click the "Calibration No." – "Robot 1:" pull-down, then with the "Job Editing" screen [Processing Conditions] tab, select "1" as the [Calibration No.]

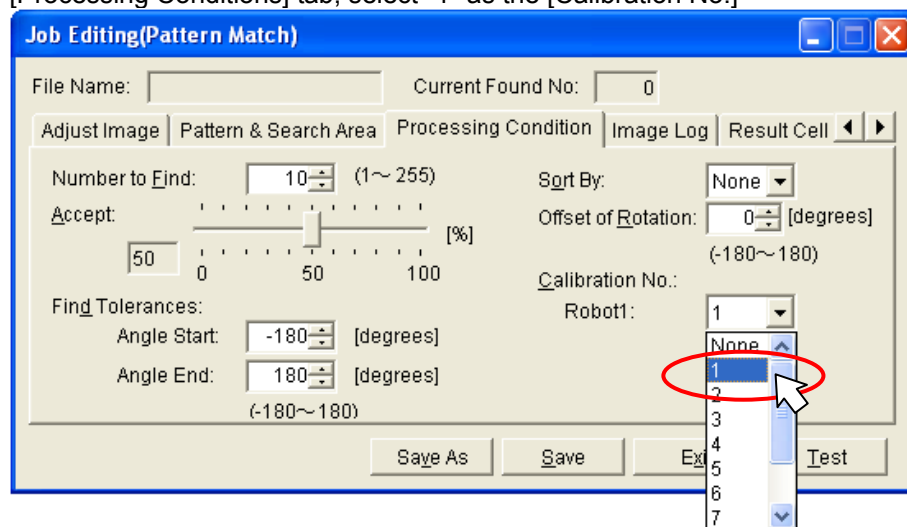

## 7 Robot Controller Settings

Place the work under the vision sensor, then click the "Job Editing" screen [Test] button.

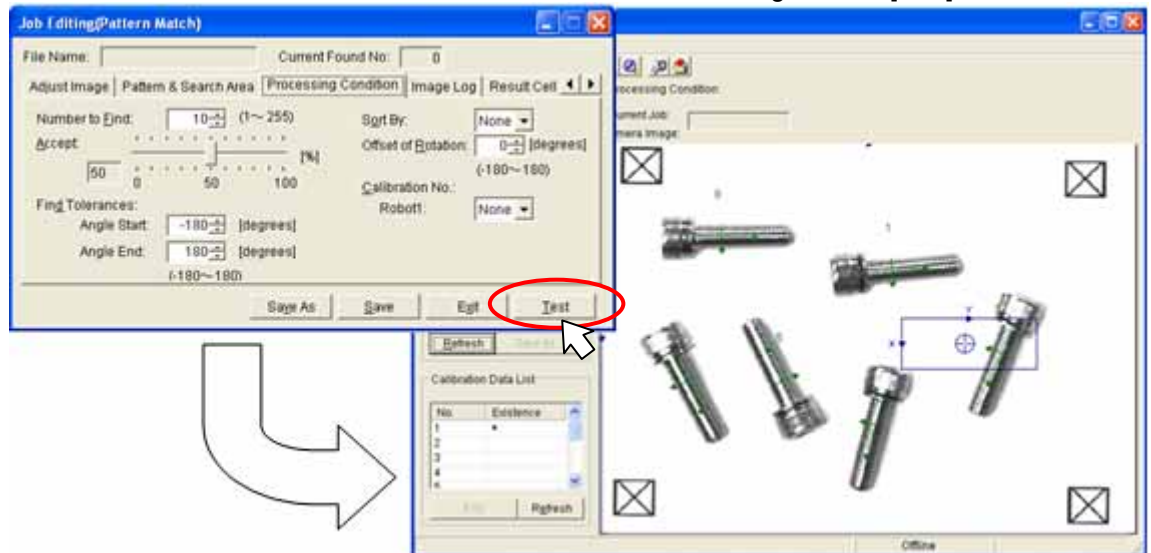

From the MELFA-Vision menu, when you click [Sensor] – [Recognition Test Results], the coordinates for the recognized work are displayed with the robot coordinate system.

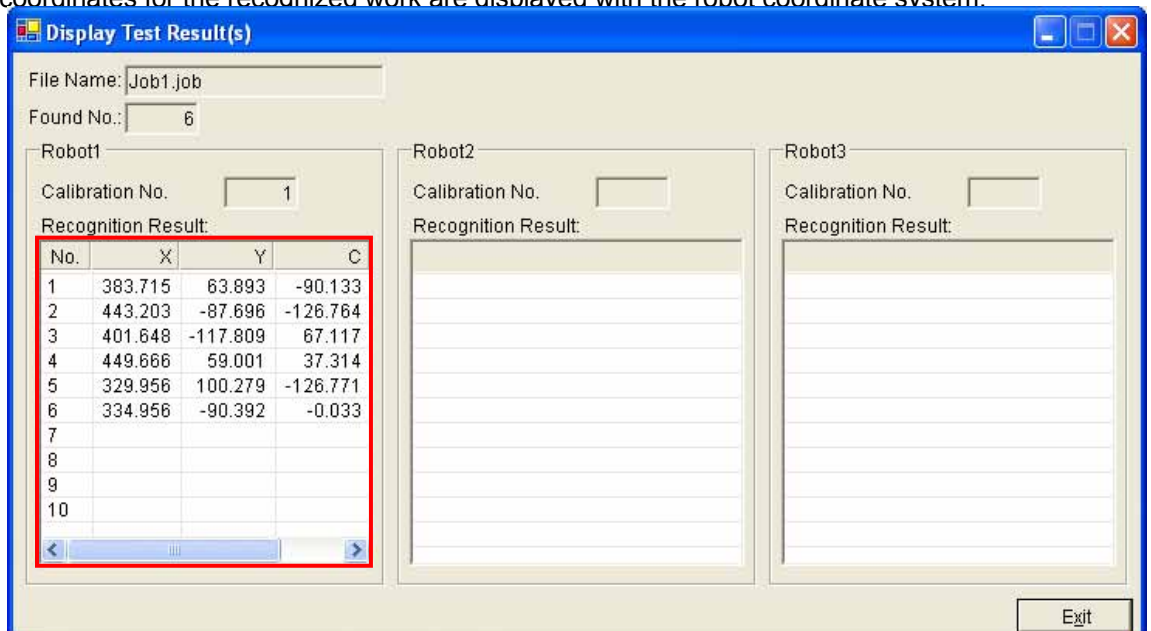

(19)The "Job Editing" screen "Calibration" specification has been changed, so the recognition conditions are saved.

Click the "Job Editing" screen [Save] button.

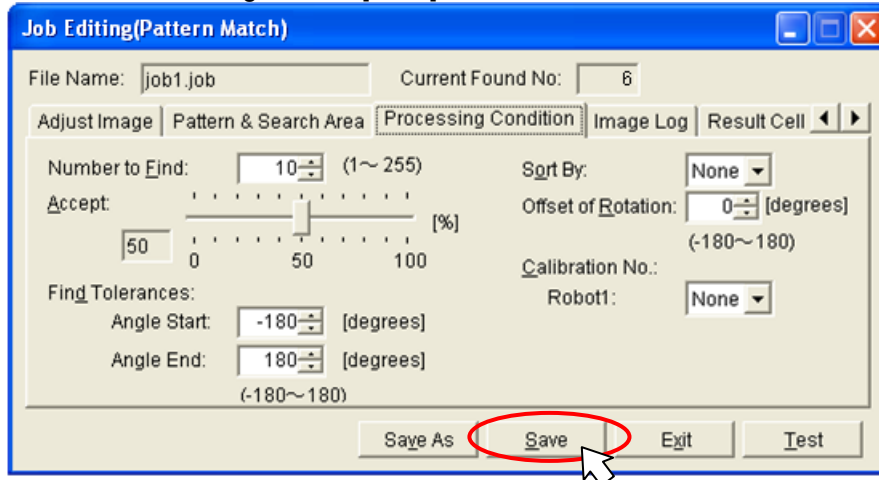

(20)Close the "Job Editing" screen.

Click the "Job Editing" screen [Exit] button.

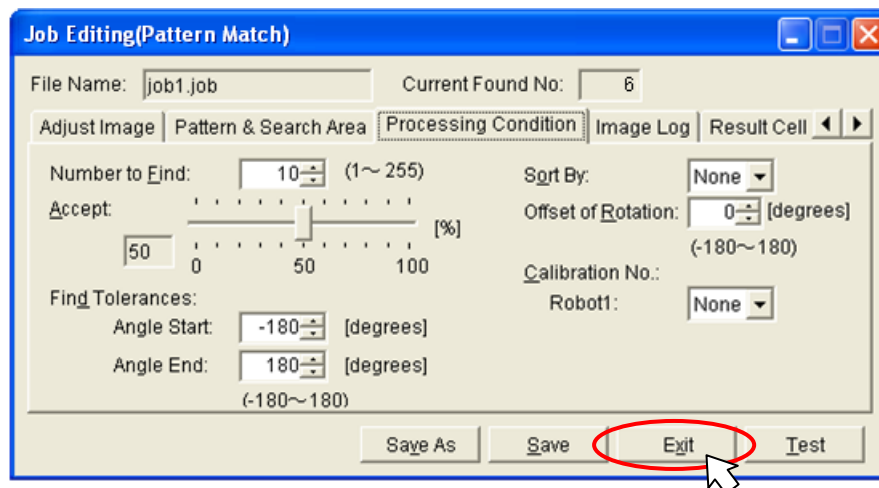

## 7.3. Robot Program Writing

In order to start (execute) image processing with the vision sensor from the robot, it is necessary to execute commands controlling the vision sensor in a robot program written in MELFA-Basic IV.

### 7.3.1. Flow for starting of image processing by robot

Next is shown the method for starting image processing from a robot program.

- ① Check the line connection with the vision sensor (State variable :M\_NVOPEN)
- ② Line connection with vision sensor (MELFA-BASIC IV :NVOPEN)
- ③ Vision program start (MELFA-BASIC IV :NVPST)
- ④ Vision sensor detection quantity acquisition (State variable :M\_NVNUM)
- ⑤ Vision detection position data acquisition (State variable :P\_NVS1 - P\_NVS8)
- ⑥ After this, the robot is moved with the position data detected with the vision sensor.

For details on the vision program dedicated MELFA-BASIC IV commands and status variables, see "9.1 Vision Sensor Dedicated Commands and Status Variables".

### 7.3.2. Writing a Sample Robot Program

The robot program below is written and stored in the robot controller. For details on the storage method, see the "RT ToolBox PC Support Software Instruction Manual".

Example acquiring data in the absolute coordinates using pattern matching

```

1 ' Before this program is run, the evacuation position P0, the work grasping position P1, and the work placement position P2 must have
already been taught.
2 ' Example: P0=(+250.000,+350.000,+300.000,-180.000,+0.000,+0.000)(7,0)
3 '   P1=(+500.000, +0.000, +100.000, -180.000, +0.000, +10.000)(7,0)
4 '   P2=(+300.000, +400.00, +100.000, -180.000, +0.000, +90.000)(7,0)
10 IF M_NVOPEN(1)<>1 THEN ' When logon has not been completed for vision sensor number 1
20   NVOPEN "COM2:" AS #1 ' Connects with the vision sensor connected to COM2.
30 ENDIF
40 WAIT M_NVOPEN(1)=1 ' Connects with vision sensor number 1 and waits for logon to be completed.
50 NVPST #1,"Job1","E76","J81","L85",0,10 ' Start vision program [Job1] and receives the number of recognitions by the
vision sensor from the [E67] cell.
60 ' and receives the recognized coordinates from the [J81] -[L85] cells, and stores this in P_NVS1 (30).
70 MOV P0 ' Moves to the evacuation point.
80 IF M_NVNUM(1)=0 THEN *NG ' If the detection count is 0, jumps to an error.
90 FOR M1=1 TO M_NVNUM(1) ' Loops once for each detection by vision sensor number 1.
100   P10=P1 ' Creates the target position P10 using the vision sensor 1 results data.
110   P10.X=P_NVS1(M1).X
120   P10.Y=P_NVS1(M1).Y
130   P10.C=P_NVS1(M1).C
140   MOV P10,10 ' Moves to 10 mm above the work grasping position P10.
150   MVS P10 ' Moves to the work grasping position P10.
160   DLY 0.1 ' Wait time of 0.1 second
170   HCLOSE 1 ' Closes hand 1
180   DLY 0.2 ' Wait time of 0.2 second
190   MVS P10,10 ' Moves to 10 mm above the work grasping position P10
200   MOV P2,10 ' Moves to 10 mm above the work placement position P2
210   MVS P2 ' Moves the work placement position P2
220   DLY 0.1 ' Wait time of 0.1 second
230   HOPEN 1 ' Opens hand 1.
240   DLY 0.2 ' Wait time of 0.2 second
250   MVS P2,10 ' Moves to 10 mm above the work placement position P2
260 NEXT M1 ' Repeats.
270 HLT ' Program pause (Create the appropriate processing.)
280 END ' Exit
290 '
300 *NG ' Error processing
310   ERROR 9000 ' Error 9000 output.
320   HLT ' Program pause (Create the appropriate processing.)
330 END ' Exit

```

- (1) The evaluation position, work grasping position, and work placement position are taught in order to operate the robot. Use the teaching box to open the stored robot program and open the position edit screen.
  - ① With the teaching box (R28TB), turn the key switch in the "Enable" direction.
  - ② Input [MENU] - [1: Teaching], then press [INP] to display the command edit screen.
  - ③ Press [POS] + [ADD] to display the position edit screen.

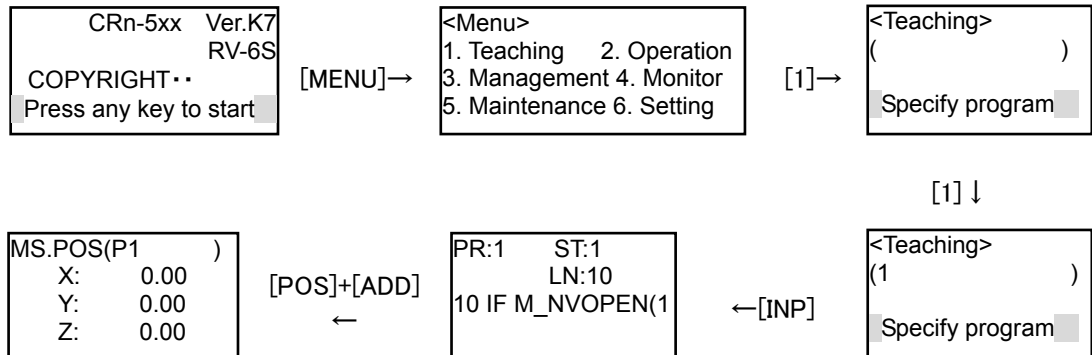

- (2) Move the robot to the evacuation position. Switch On the robot servo power supply and move the robot with Jog operation.
  - ① Press [Deadman Switch] + [STEP/MOVE] to switch on the servo power supply.
  - ② Press the [Deadman Switch] + [STEP/MOVE] + [key for each axis (for example +X/-X)] to move the robot to the evacuation point.

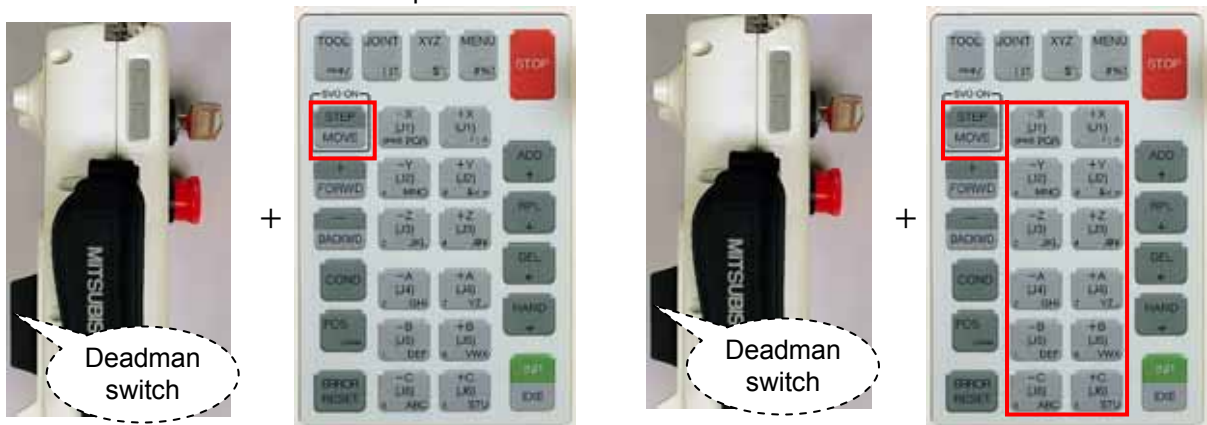

- (3) Teach the evacuation point.
  - ① Input the position name "P0" for the evacuation point in the position edit screen [POS] column or scroll the position names with [+ /FORWD] or [- /BACKWD] to display "P0".
  - ② Press [STEP/MOVE] + [ADD] + [ADD] ([ADD] twice) to store the current robot position as position name "P0".

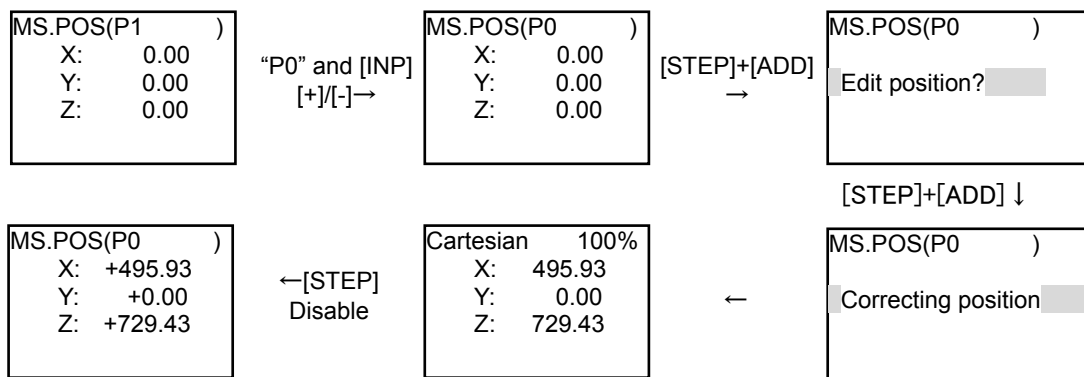

- (4) Teach the work grasping position and work placement position in the same way.
- (5) When this work is complete, press the teaching box [MENU] button to store the robot program.
- (6) Turn the teaching box key switch in the "Disable" direction.

## 7. 4. Executing the automatic operation test

This section explains automatic operation that starts the program created with “7.3 Robot Program Writing” and transports the work recognized with the vision sensor.

### 7. 4. 1. Put the vision sensor online.

In order for the robot controller to control the vision sensor, it is necessary to put the vision sensor "online". This section explains the work for putting the vision sensor online.

From the MELFA-Vision "Main" screen menu, click [Sensor] - [Online] or

click  on the toolbar button.

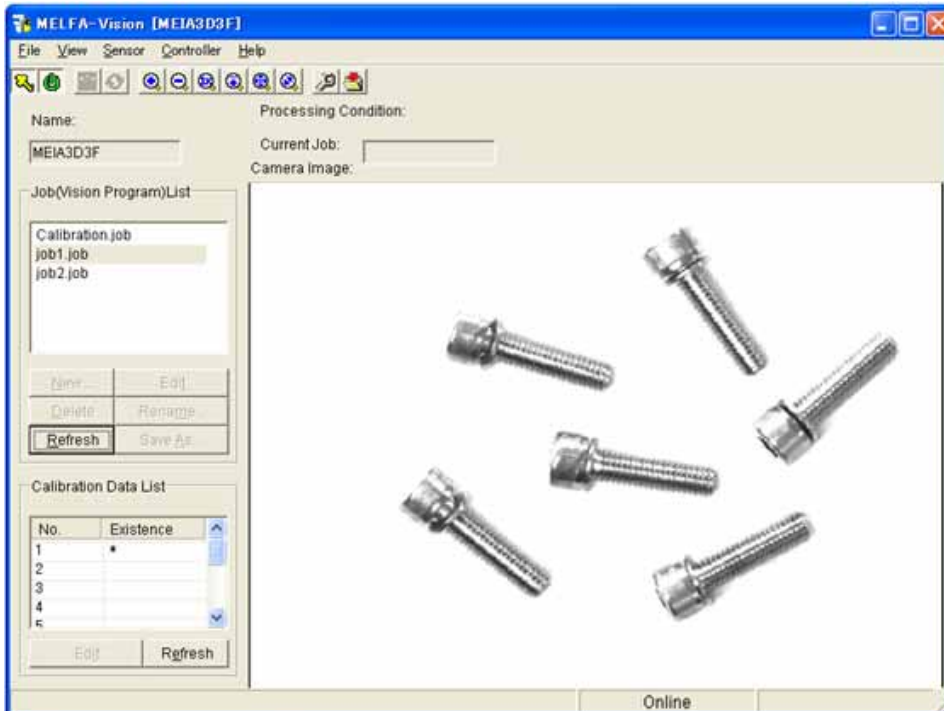

### 7. 4. 2. Test by executing each step.

Open the robot program created with the teaching box and while executing one line at a time, check the robot program operations.

For details on the step execution method, see "Detailed explanations of functions and operations (BFP-A5992)" "3.6 Debugging Operations".



## CAUTION

***There are command words not completed in a single step execution.***

When execution does not move to the next step when the step is executed one time, execute the step again.

Example: NVOPEN requires at least seven repetitions of step execution.

### 7.4.3. Starting a Robot Program

This section explains the work for starting the stored robot program "1" with the robot controller operation panel (O/P).

- ① Turn the operation panel key switch in the "Auto (Op)" direction.



- ② Press the [CHNG DISP] button to display the override at the Status Number.

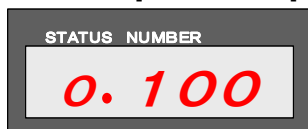

- ③ Press the [UP/DOWN] button to set the Status Number display to "o.010". (This sets the robot override to 10%.)
- ④ Press the [CHNG DISP] button to display the robot program number at the Status Number.

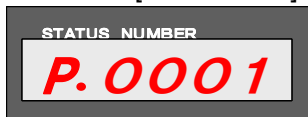

- ⑤ Press the [UP/DOWN] button to set the Status Number display to "P.0001". (This selects robot program 1.)
- ⑥ Press the [SVO ON] button to switch On the robot servo power supply.



- ⑦ Check around the robot to make sure that everything will be safe even if the robot operates.
- ⑧ Press the [START] button.



- ⑨ The main screen [Camera Image] displays the recognition results and the robot transports all the work recognized by the vision sensor. After transporting, the robot program stops.

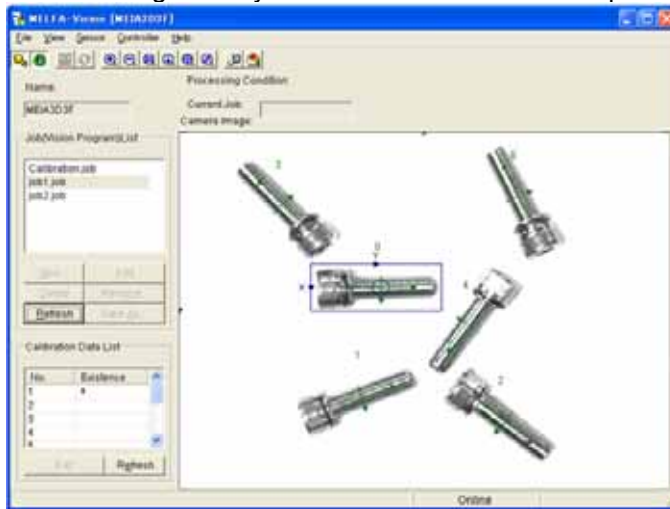



## 7.5. When the robot can not grasp the work normally

This section explains what to do if the robot program started normally, but the robot could not grasp the work normally.

### 7.5.1. Check the MELFA-Vision [Camera Image].

Check if the position of the work recognized by the vision sensor is correct.

- (1) Check the main screen [Camera Image] and check that the "+" is on the recognized work.
- (2) Check if the position of the "+" is the position specified with the "Job Editing" screen "Output position setting".

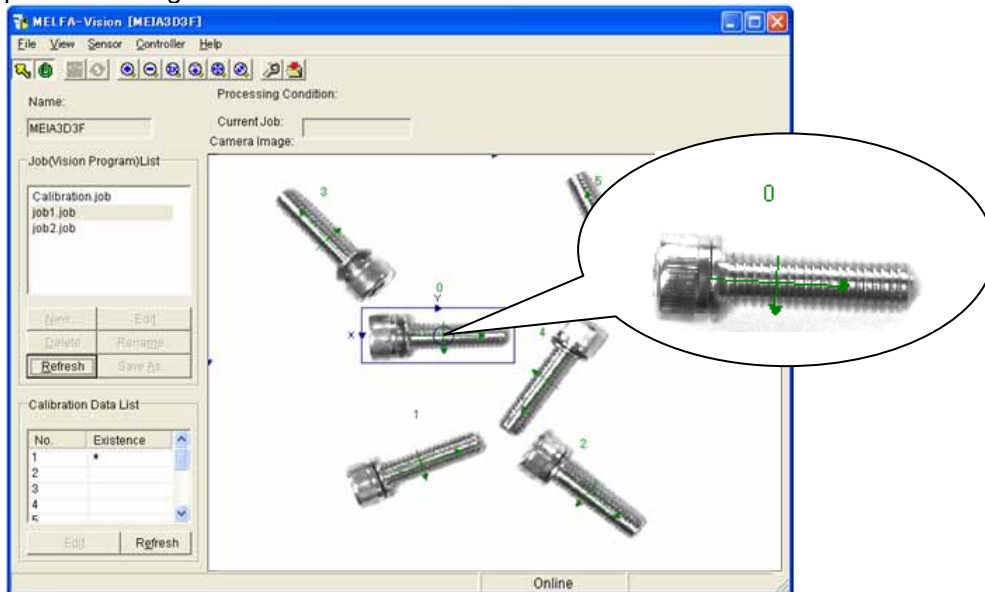

- (3) If the position of the recognized work is abnormal, re-edit the MELFA-Vision job.

### 7.5.2. Comparison of the position data for the work recognized by the vision sensor and the position data received by the robot

Check if the robot received the work position data normally from the vision sensor.

- (1) From the main screen menu, click [Sensor] - [Recognition Test Results].

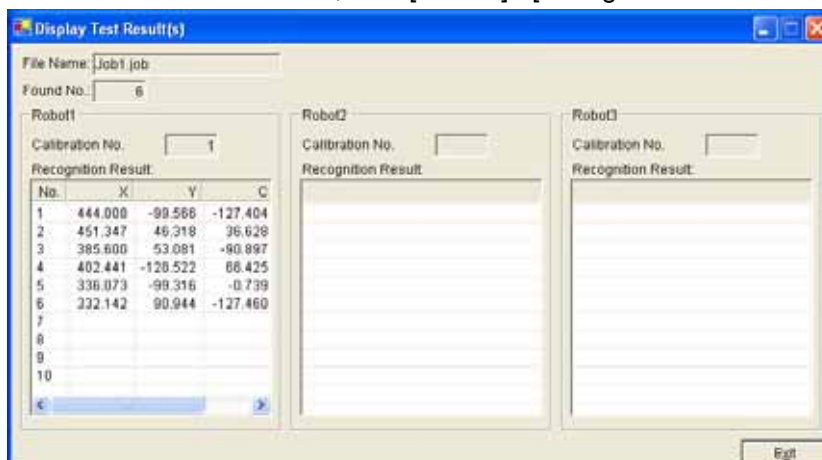

- From the main screen menu, click [Controller] - [Monitor] to display the "Monitor of Controller" screen. This screen monitors the controller's dedicated status variables for the vision sensor.

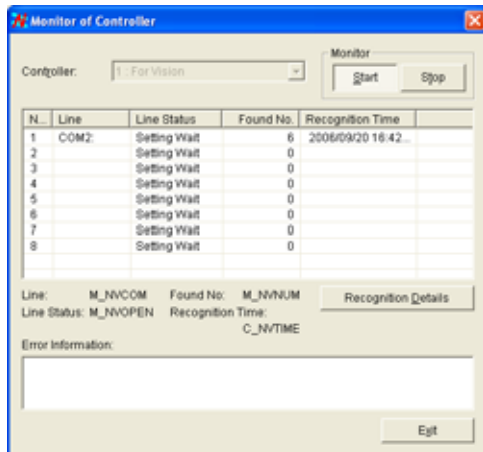

- Select the line connecting the robot controller and the vision sensor (in the explanation up till now "COM2:"), then click the [Recognition Details] button.

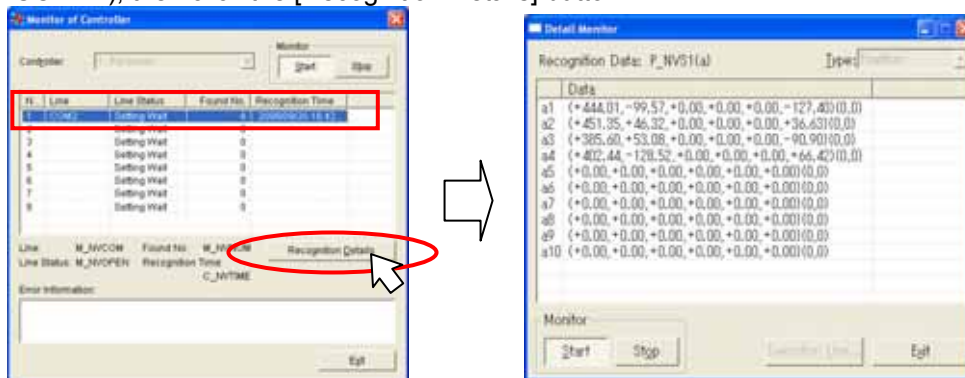

- Compare the "Display Test Result(s)" screen and "Detail Monitor" screen "P\_NV51" values to check if the robot controller is receiving the data normally.

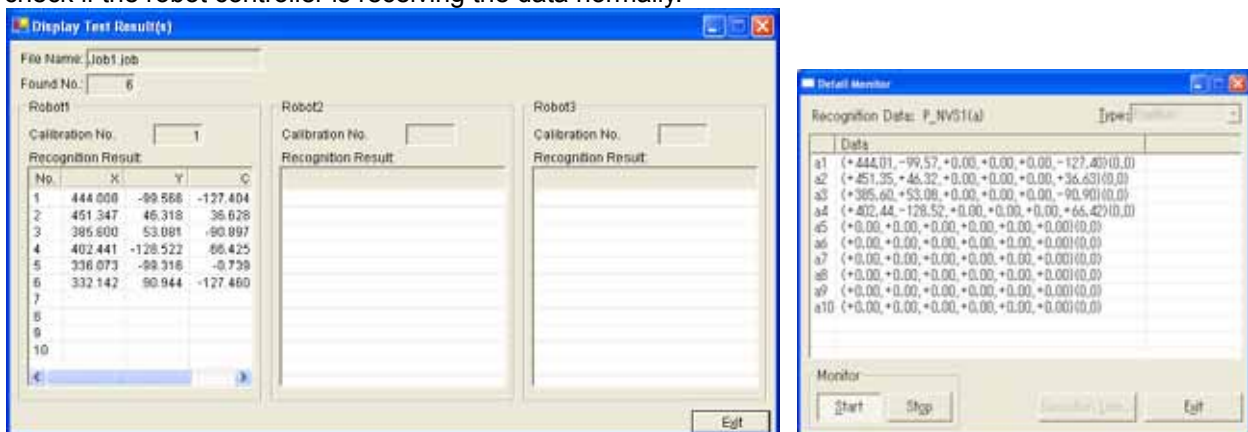

- If the work position data received by the robot is abnormal, check the [Start Cell] and [End Cell] positions specified with the robot program "NVPST" command.
- If the work position data received by the robot is normal, re-do the calibration setting.

## 8. Maintenance

This chapter explains vision sensor data backup and restoration, the image log function, vision sensor cloning, the startup function, and user list registration overall maintenance.

### 8.1. Vision Sensor Data Backup

The backup function stores on a PC all the files (\*.job, \*.bmp, \*.jpg, proc.set and hosts.net) stored on the vision sensor.

This function can be used with the specified vision sensor either Online or Offline.

Also, although this function can be used with the specified vision sensor either logged on or logged off, since the robot and vision sensor access can be slowed down by file transfer operations, normally back up with the vision sensor offline.

This section backup work using MELFA-Vision.

- (1) Display the MELFA-Vision backup screen.  
From the MELFA-Vision menu, click [Sensor] - [Backup] to display the "Backup" screen.
- (2) From the "Backup" screen "Sensor List", select the vision sensor to back up.  
The destination to which backed up files are transferred can be changed with the [Browse] button.  
Select whether to back up all of the files in the selected vision sensor, or to back up only the vision programs, and then click the [Backup] button.

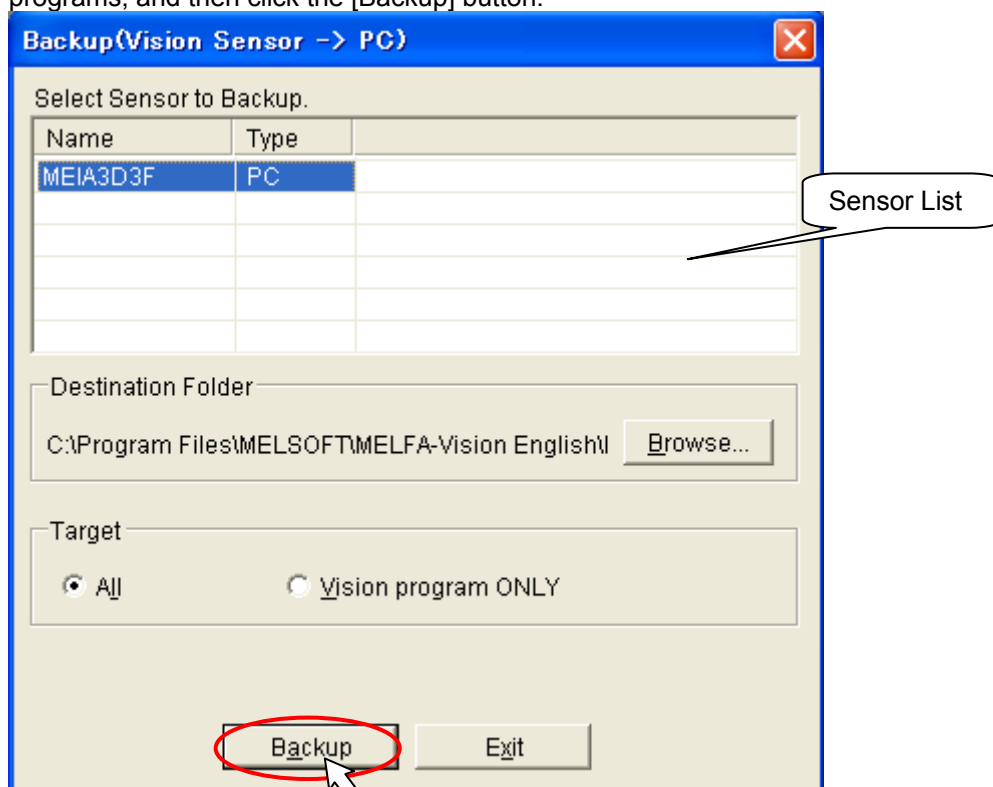

- (3) If you select a vision sensor other than the one currently logged on the "User Name And Password" screen is displayed, so input the user name and password for the vision sensor to be backed up, then click the [OK] button.

This screen is not displayed if the currently logged on vision sensor is selected with the "Sensor List".

This screen is also not displayed if a sensor is selected that is not logged on but that vision sensor can be logged on with the currently logged on user name and password.

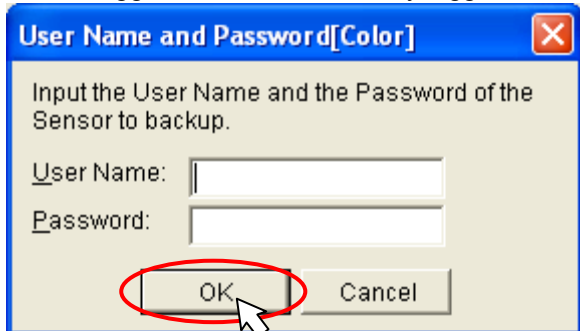

- (4) A confirmation screen is displayed, so check the contents, then click the [Yes] button.  
\* A vision sensor can be backed up even when it is online, but file transfer operations may delay the robot and vision sensor access.

- (5) When the backup starts, the indicator progresses as on the screen below. To cancel a backup that is underway, click the [Stop] button.

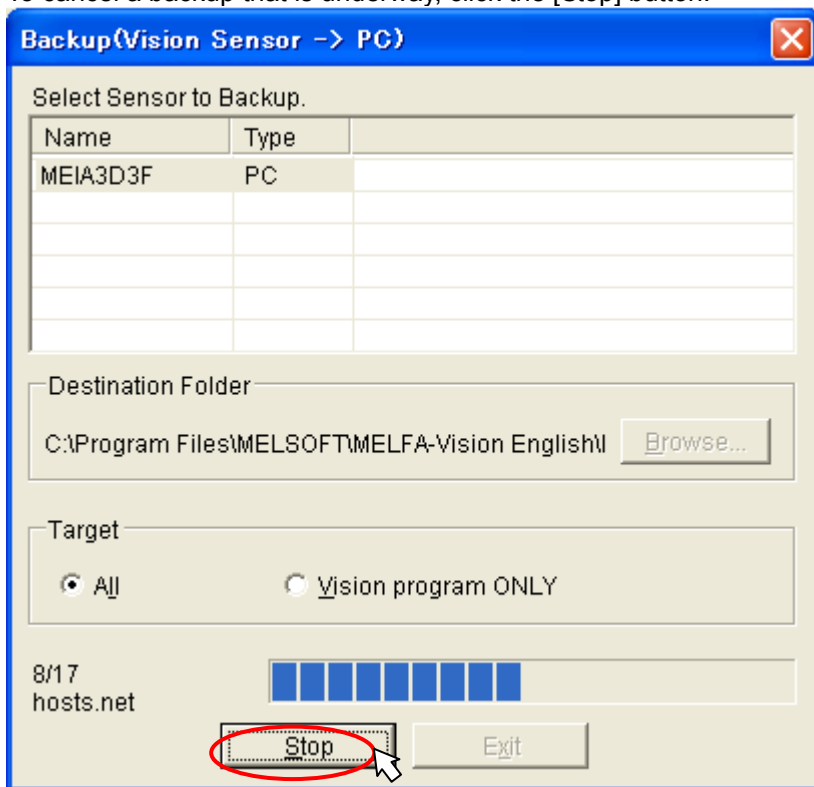

- (6) When the backup is complete, the completion message is displayed. When the [OK] button is clicked, display returns to the "Backup" screen.

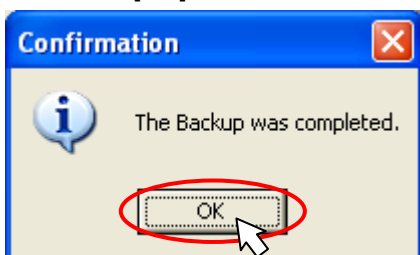

## 8. 2. Vision Sensor Data Restoration

The restore function takes the files backed up to the PC with the backup function and returns them to the vision sensor.

The restored files are all the files that were backed up.

This function can be used with the vision sensor either logged on or logged off.

Also, although this function can be used with the specified vision sensor either Online or Offline, since the robot and vision sensor access can be slowed down by file transfer operations, it is recommended to restore with the vision sensor offline.

This section explains restoration work using MELFA-Vision.

- (1) Display the MELFA-Vision restore screen.

From the MELFA-Vision menu, click [Sensor] - [Restore] to display the "Restore" screen.

- (2) Specify the folder to transfer from.

The folder to transfer from can be changed with the [Browse] button.

Select the vision sensor to restore from the "Sensor List".

Select whether to restore all files or only the vision program, and then click the [Restore] button.

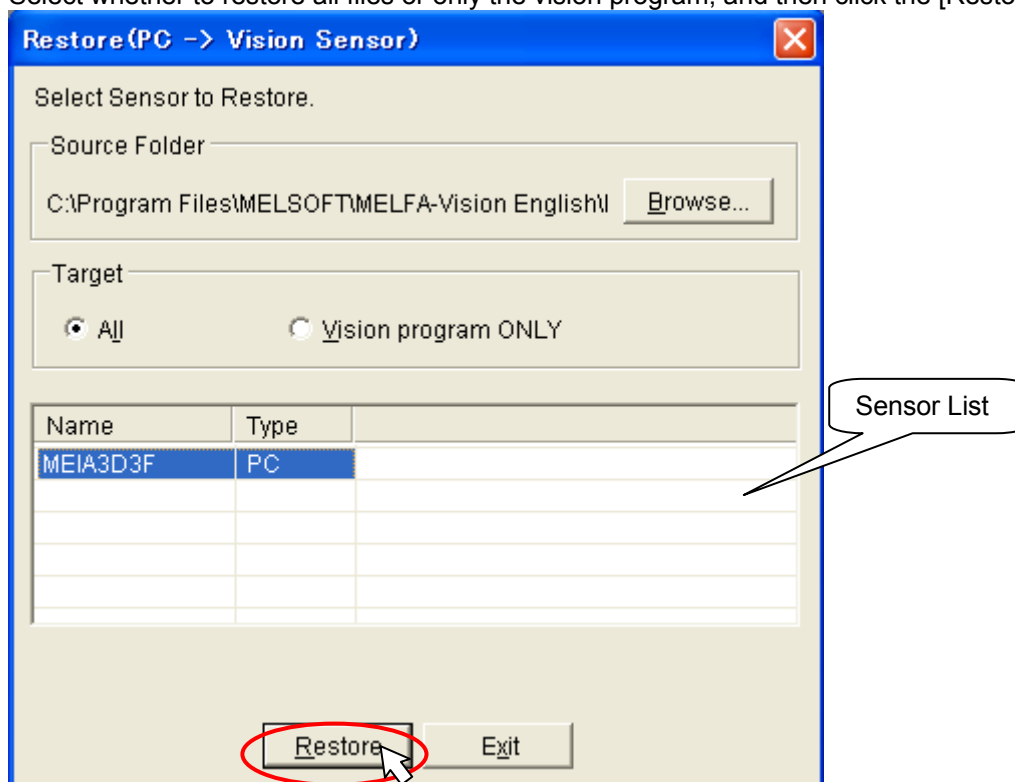

- (3) If you select a vision sensor other than the one currently logged on to, the "User Name and Password" screen is displayed, so input the user name and password for the vision sensor to be restored, then click the [OK] button.

This screen is not displayed if the currently logged on vision sensor is selected with the "Sensor List".

This screen is also not displayed if a sensor is selected that is not logged on but that can be logged onto with the currently logged on user name and password.

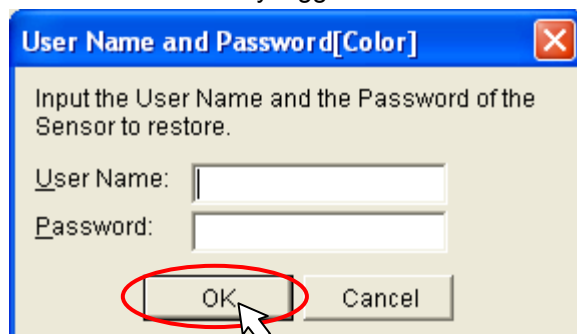

- (4) A confirmation screen is displayed, so check the contents, then click the [Yes] button.
- (5) A confirmation screen is displayed to ask whether or not to enable restoration of the vision sensor network setting files.

To restore the vision sensor setting file (proc.set) and the host table file (hosts.net) vision sensor network setting file too, click the [Yes] button.

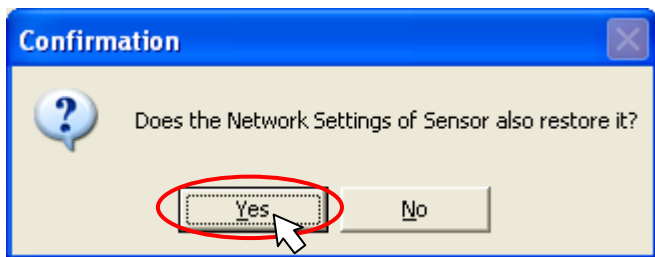

**CAUTION**

**Only restore a network setting file to the sensor it was backed up from.**  
Restoring a network settings file to any other sensor can cause trouble.

- (6) When the restoration starts, the indicator progresses as on the screen below. To cancel a restoration that is underway, click the [Stop] button.

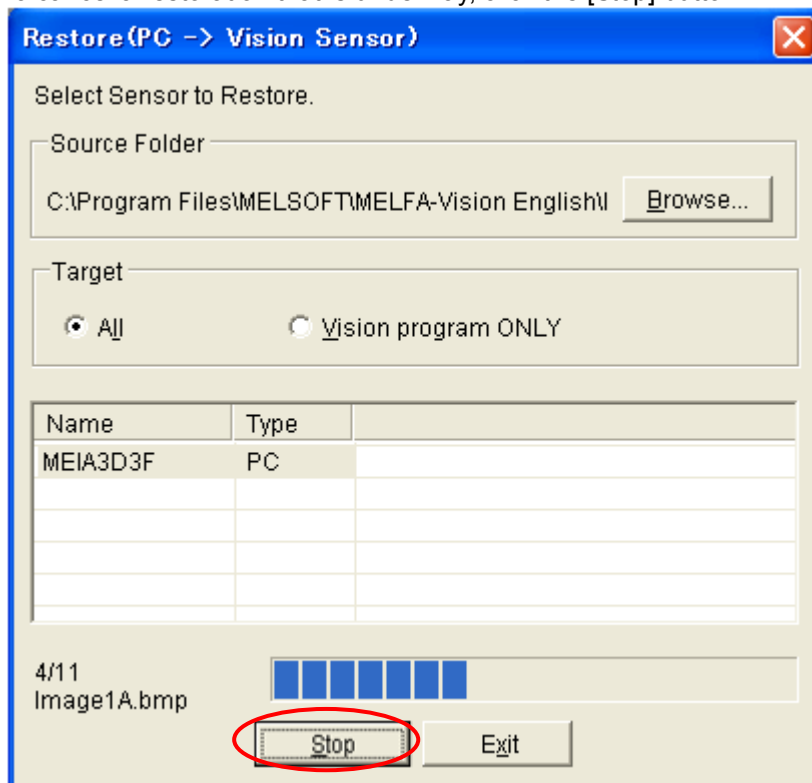

- (7) When the restoration is complete, the completion message is displayed.  
To reflect the restoration settings, restart the vision sensor.  
When the [OK] button is clicked, display returns to the [Backup from Vision Sensor] screen.

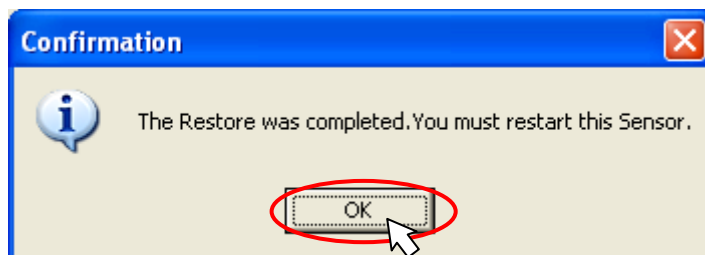

### 8. 3. Vision Sensor Cloning

The cloning function can create multiple vision sensors with the same files as the original one vision sensor.

This function can be used with the vision sensors either logged on or logged off.

Also, although this function can be used with the vision sensors either Online or Offline, since the robot and vision sensor access can be slowed by file transfer operations, it is recommended to restore with the vision sensor offline.

This section explains cloning work using MELFA-Vision.

- (1) Display the MELFA-Vision cloning screen.  
From the MELFA-Vision menu, click [Sensor] - [Clone To] to display the "Clone" screen.
- (2) Select the vision sensor to be the cloning source and the vision sensor to be turned into a clone on the "Clone" screen. Multiple vision sensors can be selected. To select multiple vision sensors, select with mouse operations while pressing down the keyboard [Shift] key or [Ctrl] key. Select whether to back up all files from the clone source vision sensor and create clones, or to create clones of only the vision program, and then click the [Clone] button

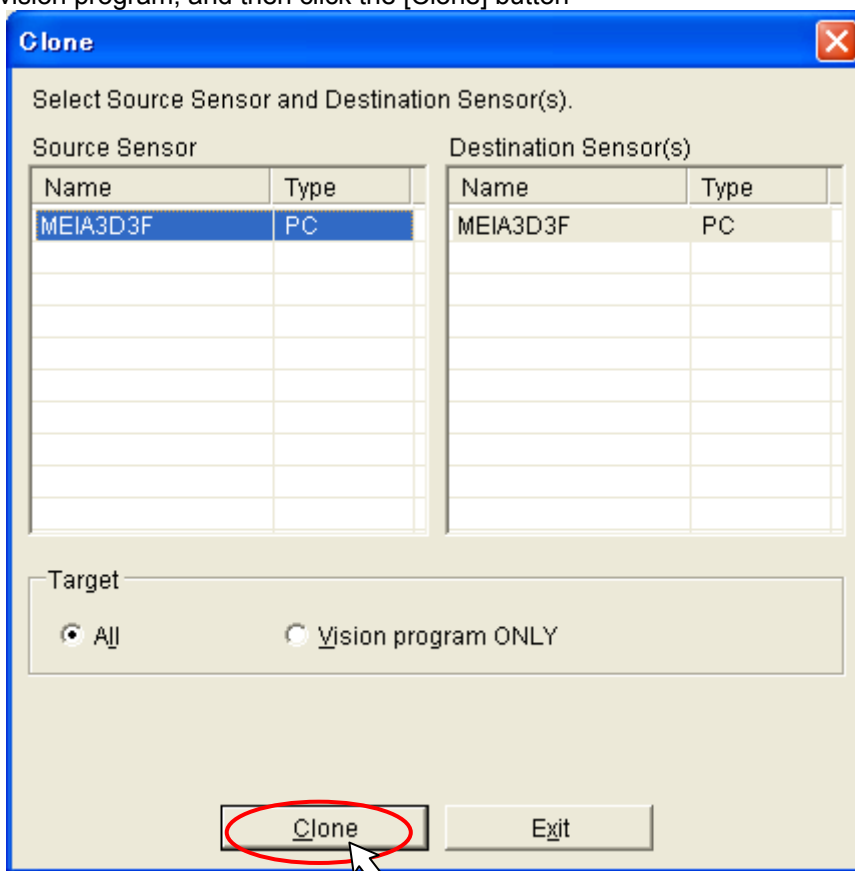

- (3) If the clone source vision sensor(s) and the vision sensor(s) to be cloned from it are different, the following warning message is displayed.  
To continue the work, click the [Yes] button; to cancel it, click the [No] button.

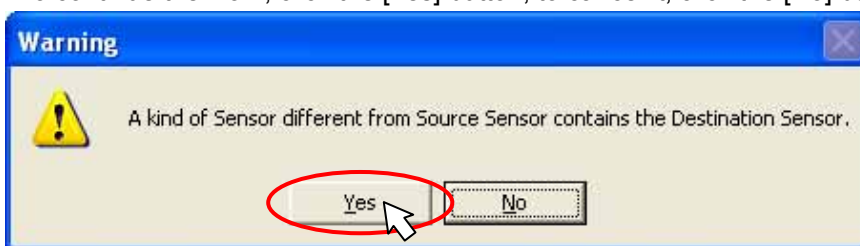



- (4) A confirmation screen is displayed, so check the contents, then click the [Yes] button.
- (5) When the cloning work starts, the indicator progresses as on the screen below.  
To cancel cloning work that is underway, click the [Stop] button.

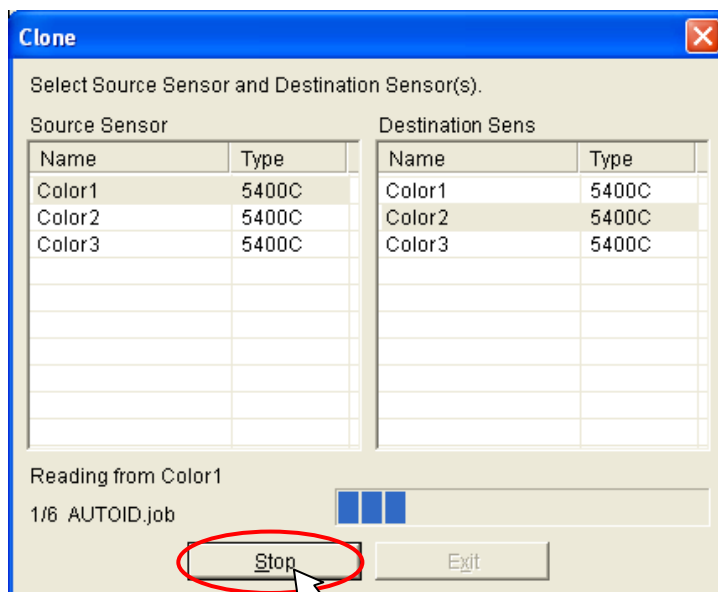

- (6) When the cloning is complete, the completion message is displayed.  
To reflect the restoration settings, restart the vision sensor.  
When the [OK] button is clicked, display returns to the "Clone" screen.

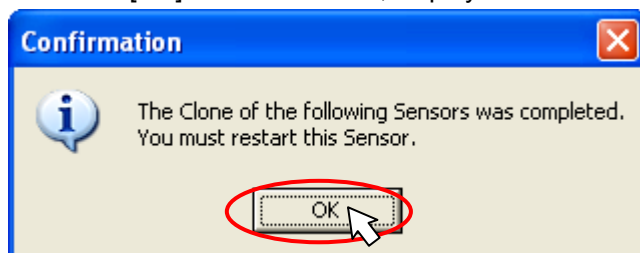

## 8. 4. Image Log Acquisition Settings and Reception Start/End

The image log acquisition function is a function that stores the images captured by the vision sensor with the conditions set with the job (Always/OK images/NG images) while the vision sensor is communicating with the controller in online mode.



Using this function makes it possible to check afterwards on images that could not be recognized and track down the reason why they could not be recognized.

In order to acquire the image log, the FTP server is started on the PC on which the images are stored, so set the FTP server user name and password.

This section explains the method for acquiring the image log using MELFA-Vision.

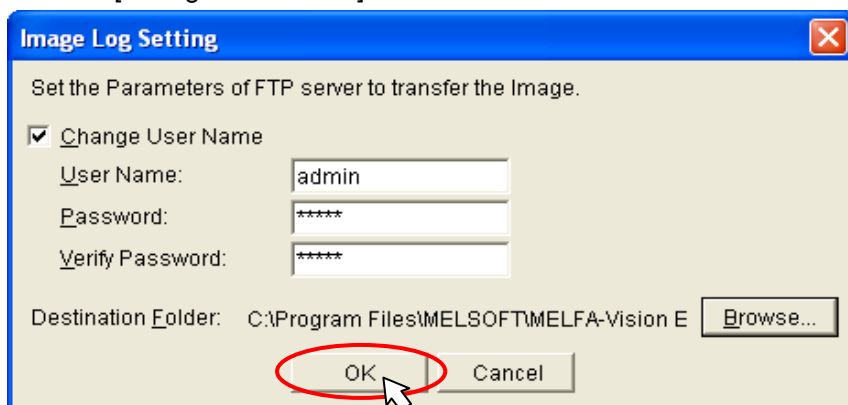
- (1) Display the MELFA-Vision image log setting screen.  
From the MELFA-Vision menu, click [Sensor] - [Image Log] - [Setting] or from the MELFA-Vision tool bar, click  to display the "Image Log Setting" screen.
- (2) Enter the FTP server user name and password on the displayed "Image Log Setting" screen.  
This user name and password are the ones for the FTP server and are different from the user name and password for logging on to the vision sensor. However, the same user name and password may be set for both.  
Also, enter here the same user name and password as for the "Job Editing" screen "Image Log" tab "User Name of FTP" and "Password of FTP".  
For details on the "Image Log" tab setting method, see "9.2.2 Job Editing screen ([Image Log] tab)".  
The storage destination for acquired images can be changed with the [Browse] button.  
When the settings are complete, click the [OK] button to close the "Image Log Setting" screen.  
The next time the "Image Log Setting" screen is opened, the screen is opened with the same settings as the previous time. To make the same settings as the previous time, remove the check from the [Change User Name] check box.



- (3) When the image log is started, the FTP server is started.  
From the MELFA-Vision menu, click [Sensor] - [Image Log] - [Start Log] or from the MELFA-Vision tool bar, click  .  
When the FTP server starts up and image log reception becomes possible, **Image Log Mode** is displayed at the right end of the status bar of the MELFA-Vision main screen.  
In this state, the vision sensor images are stored in the specified folder under the conditions set with the "Jog Editing" screen "Image Log" tab.
- (4) When the image log is ended, the FTP server is ended.  
From the MELFA-Vision menu, click [Sensor] - [Image Log] - [Quit Log] or from the MELFA-Vision tool bar, click  .  
When the image log processing ends, **Image Log Mode** is no longer displayed at the right end of the status bar of the MELFA-Vision main screen.

## 8. 5. Vision Startup Settings

The startup settings are a function that sets the startup conditions for when the power supply to the vision sensor is switched On (select whether to start up online or offline and select the job to load). This section explains the work for setting the startup using MELFA-Vision.

- (1) Display the MELFA-Vision startup screen.  
From the MELFA-Vision menu, click [Sensor] - [Startup] to display the "Startup" screen.
- (2) Select whether to start up online or offline and what job to load when starting the vision sensor.  
To start online, put a check in the [Online] checkbox. To start offline, remove the check from the checkbox.  
The jobs in the vision sensor are displayed in the [Job] drop-down list so select the job to load. If there is no particular job to specify, select [<New>].  
When the settings are complete, click the [OK] button.  
The "Startup" screen is closed and display returns to the main screen.

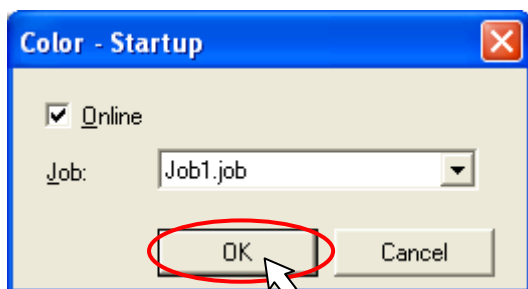

## 8. 6. User List Settings

The user list settings function is the function that sets the access rights for users that use the vision sensor, the FTP read and write rights, and password settings.

This section explains the work for setting the user list using MELFA-Vision.

- (1) Display the MELFA-Vision "User List" screen.  
From the MELFA-Vision menu, click [Sensor] - [User List] to display the "User List" screen.
- (2) The "User List" screen is displayed.

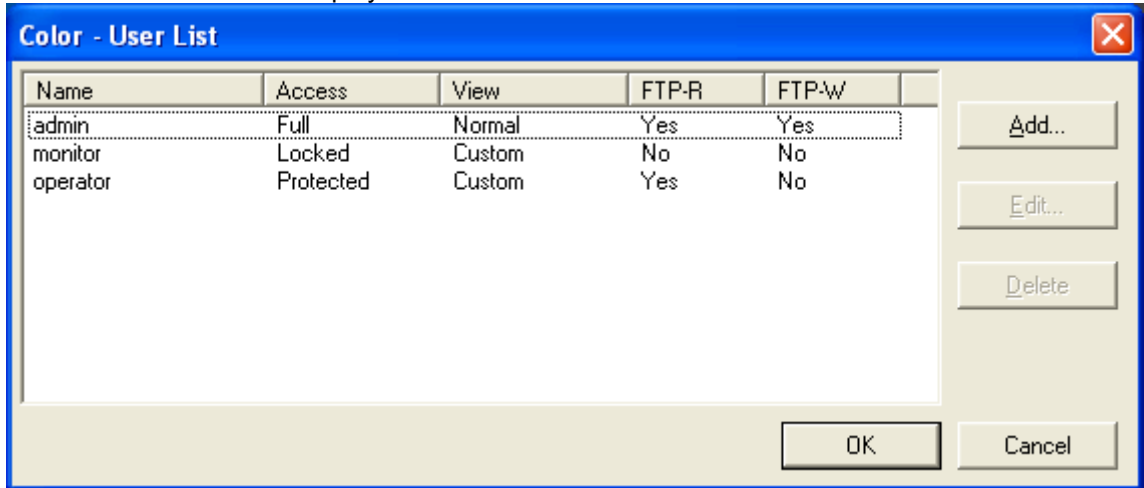

There are three types of user access rights.

**Table 8-1 List of User Access Rights for Vision Sensors**

Access	Explanation
Full	The user has full access (without restriction) to the vision sensor. The job can be loaded, edited, and stored. Normally log on with this right when using MELFA-Vision.
Protected	This user is not permitted to do FTP writing under the initial conditions. However, it is possible for writing to be permitted.
Locked	This user is only permitted to check the vision sensor processing state with the MELFA-Vision camera picture.

There are two types of display item settings - normal and custom; for MELFA-Vision, the custom view is not displayed even if custom is selected.

FTP writing and reading can be permitted and prohibited with [Yes] and [No].

Also, the following three types of users can be set for the initial state for the vision sensor. The respective settings are shown in the table below.

**Table 8-2 Registered User Name List**

User name	Password	Access	Display	FTP writing	FTP reading
admin	None	Full	Normal	○	○
monitor	None	Locked	Custom	×	×
operator	None	Protected	Custom	○	×

- (3) To add a user, click the [Add] button on the "User List" screen; to edit an existing user, select the user from the list and click the [Edit] button.  
The "User" screen is displayed, so set the required items and click the [OK] button.

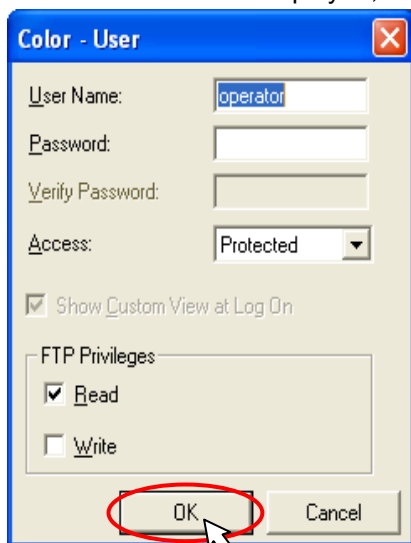

Color - User

User Name: operator

Password:

Verify Password:

Access: Protected

Show Custom View at Log On

FTP Privileges:

Read

Write

OK Cancel

- (4) To delete an existing a user, select the user from the "User List" screen list and click the [Delete] button.  
Check the contents of the confirmation screen, then click the [Yes] button.

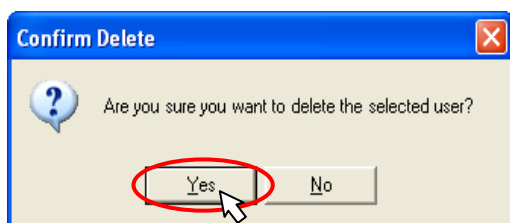

Confirm Delete

Are you sure you want to delete the selected user?

Yes No

\* The "admin" user can not be deleted.

- (5) When the settings are complete, click the [OK] button on the "User List" screen. The "User List" screen is closed and display returns to the main screen.

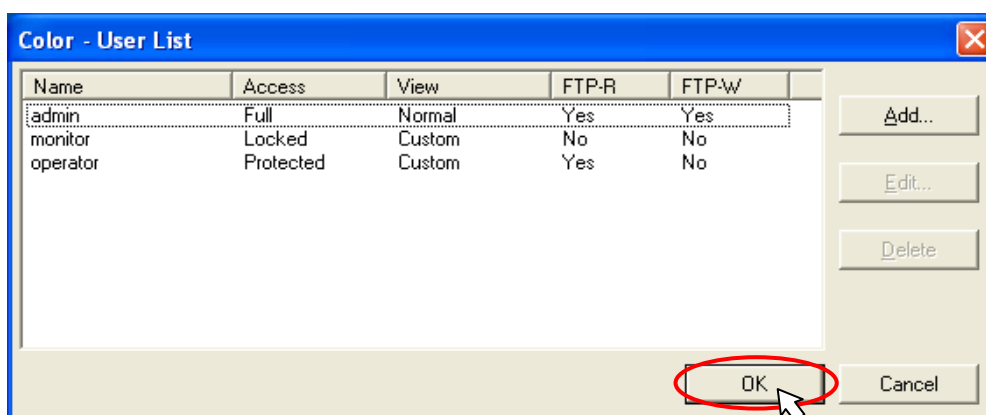

Color - User List

Name	Access	View	FTP-R	FTP-W
admin	Full	Normal	Yes	Yes
monitor	Locked	Custom	No	No
operator	Protected	Custom	Yes	No

Add... Edit... Delete

OK Cancel

## 9. Detailed Explanation of Functions

This chapter explains the functions of this product in detail.

### 9. 1. Vision Sensor Dedicated Commands and Status Variables

The robot controller has status variables and dedicated commands for controlling vision sensors. This section explains these dedicated commands and status variables.

#### 9. 1. 1. How to Read Items

[Function]	: Shows the command word function.
[Format]	: Shows the command word argument input method. <> indicates an argument. [ ] indicates that it can be omitted. □ indicates that a space is required.
[Term]	: Shows the argument meaning, range, etc.
[Sample sentence]	: Shows a sample sentence.
[Explanation]	: Shows the functions in detail and caution item.
[Error]	: Shows an error generated when the command word is executed.

#### 9. 1. 2. MELFA-BASIC IV Commands

Here are the dedicated vision sensor commands.

**Table9-1 List of Dedicated Vision Sensor Commands**

Command word	Contents
NVOPEN	Connects with the vision sensor and logs on to the vision sensor.
NVPST	Starts the specified vision program and receives the results.
NVRUN	Starts the specified vision program.
NVIN	Receives the results of the vision program specified with the NVRUN command.
NVCLOSE	Cuts off the connection with vision sensor.
NVLOAD	Puts the specified vision program into the state in which it can be started.
NVTRG	Requests the vision sensor to capture an image and acquires the encoder value after the specified time.

Additional command word details are shown below.

**(1) NVOPEN (network vision sensor line open)**

[Function]

Connects with the specified vision sensor and logs on to that vision sensor.

[Format]

NVOPEN " <COM number> " AS # <Vision sensor number>
---

[Term]

**<Com number>** (Can not be omitted):

Specify the communications line number in the same way as for the Open command.

"COM1:" can not be specified by it is monopolized by the operation panel front RS-232C.

Setting range: "COM2:" – "COM8:"

**<Vision sensor number>** (Can not be omitted)

Specifies a constant from 1 to 8 (the vision sensor number). Indicates the number for the vision sensor connection to the COM specified with the &lt;COM number&gt;.

Be careful. This number is shared with the &lt;file number&gt; of the Open command.

Setting range: 1 – 8

[Sample sentence]

```

100 IF M_NVOPEN(1)<>1 THEN 'If vision sensor number 1 log on is not complete
110 NVOPEN "COM2:" AS #1 ' Connects with the vision sensor connected to COM2 and sets its
number as number 1.
120 ENDIF
130 WAIT M_NVOPEN(1)=1 ' Connects with vision sensor number 1 and waits for logon to be
completed.
```

[Explanation]

- 1) Connects with the vision sensor connected to the line specified with the <COM number> and logs on to that vision sensor.
- 2) It is possible to connect to a maximum of 7 vision sensors at the same time. <Vision sensor numbers> are used in order to identify which vision sensor is being communicated with.
- 3) When used together with the Open command, the Open command <COM number> and <File number> and the <COM number> and <Vision sensor number> of this command are shared, so use numbers other than those specified with the Open command <COM number> and <File number>.

Example: Normal example

```

10 OPEN "COM1:" AS #1
20 NVOPEN "COM2:" AS #2
30 NVOPEN "COM3:" AS #3
```

Error example

```

10 OPEN "COM2:" AS #1
20 NVOPEN "COM2:" AS #2 =><COM number> used
30 NVOPEN "COM3:" AS #1 =><Vision sensor
number>
```

Used

It is not possible to open more than one line in a configuration with one robot controller and one vision sensor. If the same IP address is set as when the [NETHSTIP] parameter was set, an "Ethernet parameter NETHSTIP setting" error occurs.

- 4) Logging on to the vision sensor requires the "User name" and "Password". It is necessary to set a user name for which full access is set in the vision sensor and the password in the robot controller [NVUSER] and [NVPSWD] parameters.

The user name and password can each be any combination of up to **15** numbers (0-9) and letters (A-Z). **(T/B only supports uppercase letters, so when using a new user, set the password set in the vision sensor with uppercase letters.)**

The user name with full access rights when the network vision sensor is purchased is "admin". The password is "". Therefore, the default values for the [NVUSER] and [NVPSWD] parameters are [NVUSER] = "admin" and [NVPSWD] = "".

When the "admin" password is changed with MELFA-Vision or a new user is registered, change the [NVUSER] and [NVPSWD] parameters. When such a change is made, when the content of the [NVPSWD] parameter is displayed, "\*\*\*\*\*" is displayed. If the vision sensor side password is changed, open the [NVPSWD] parameter and directly change the displayed "\*\*\*\*\*" value. After the making the change, reset the robot controller power.

[Caution]

When multiple vision sensors are connected to one robot controller, set the same user name and

password for all of them.

- 5) The state of communications with the network vision sensor when this command is executed can be checked with M\_NVOPEN. For details, see the explanation of M\_NVOPEN.
- 6) If the program is cancelled while this command is being executed, it stops immediately. In order to log on to the vision sensor, it is necessary to reset the robot program, then start.
- 7) When this command is used with multi-tasking, there are the following restrictions.  
The <COM number> and <Vision sensor number> must not be duplicated in different tasks.

① If the same <COM number> is used in another task, the **"attempt was made to open an already open communication file"** error occurs.

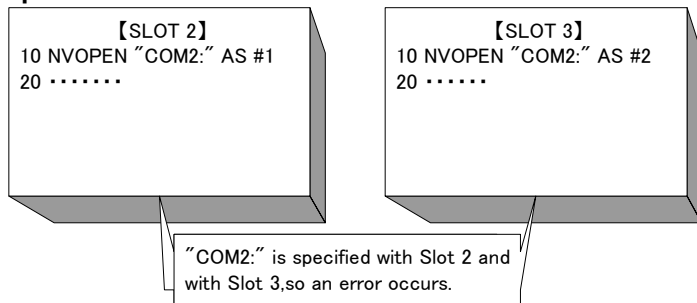

② If the same vision sensor number is used in another task, the **"attempt was made to open an already open communication file"** error occurs.

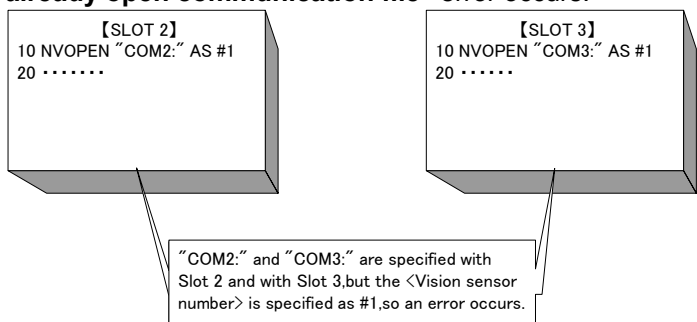

- 8) A program start condition of "Always" and the continue function are not supported.
- 9) Three robots can control the same vision sensor at the same time. If a fourth robot logs on, the line for the first robot is cut off, so be careful when constructing the system.
- 10) The line is not closed with an End command in a program called out with a CALLP command, but the line is closed with a main program End command. The line is also closed by a program reset.
- 11) If an interrupt condition is established while this command is being executed, the interrupt processing is executed immediately even during processing of this command.

[Error]

- 1) If data type for an argument is incorrect, the **"syntax error in input command"** error is generated.
- 2) If there is an abnormal number of command arguments (too many or too few), the **"incorrect argument count"** error occurs.
- 3) If the character specified in <COM number> is anything other than "COM2:" through "COM8:", the **"argument out of range"** error occurs.
- 4) If the value specified as the <vision sensor number> is anything other than "1" through "8", the **"argument out of range"** error occurs.
- 5) If a <COM number> for which the line is already connected is specified (including the <File number> for which the line has been opened with an Open command), the **"attempt was made to open an already open communication file"** error occurs.
- 6) If the vision sensor is not connected before the line is opened, the **"vision sensor not connected"** error occurs. (The same set manufacturer parameter [COMTIMER] as in the Ethernet specifications is used. Currently "1s")
- 7) If the same <COM number> or the same <vision sensor number> is specified in another task, the **"attempt was made to open an already open communication file"** error occurs.
- 8) If the user name or password specified in the [NVUSER] parameter (user name) and [NVPSWD] (password) is wrong, the **"wrong password"** error occurs.
- 9) If the communications line is cut while this command is being executed, the **"abnormal communications"** error occurs and the robot controller side line is closed.
- 10) If a program is used for which the starting condition is "Always", the **"this command can not be used if the start condition is ERR or ALW"** error occurs.



## (2) **NVPST (Network vision program start)**

[Function]

Starts the specified vision program and obtains the results.  
The data received from the vision sensor is stored in the robot controller robot status variables.

[Format]

```
NVPST□#<Vision sensor number>,"<Vision program (job) name>"
    , "<Recognition count cell>", "<Start cell>", "<End cell>", <Type> [, <Timeout>]
```

[Term]

- <Vision sensor number>** (Can not be omitted)  
This specifies the number of the vision sensor to control.  
Setting range: 1 - 8
- <Vision program (job) name>** (Can not be omitted)  
Specifies the name of the vision program to start.  
The vision program extension (.job) can be omitted.  
The only characters that can be used are "0" – "9", "A" – "Z", "a" – "z", "-", and "\_".
- <Recognition count>** (Can not be omitted)  
Specifies the cell in which the count of work recognized by the vision sensor is stored.  
Setting range: Row: 0-399 Column: "A" – "Z" Example: "A5"  
The count of work recognized by the vision sensor stored in the specified cell is saved in M\_NVNUM(\*).(\*=1 – 8)  
\* When a vision program is created with MELFA-Vision, see "9.2.3Job edit screen ([Result Cell Position] tab)" and input the value indicated by MELFA-Vision.
- <Start cell>/<End cell>** (Can not be omitted)  
Specifies the cell range (rows and columns) in which the results recognized by the vision sensor are stored.  
The contents of the specified cell are stored in any of the status variables P\_NV\*(30)·M\_NV\*(30,10)·C\_NV\*(30,10).(\*=1 - 8)  
Setting range: Row: 0-399 Column: "A" – "Z" Example: "A5", "C10", etc.  
However, the error "**specified cell value out of range**" occurs when the number of data that the range specified by < Start cell > and < End cell > is included in row 30, column 10 or the cell exceeds as many as 90.  
\* When a vision program is created with MELFA-Vision, see "9.2.3Job edit screen ([Result Cell Position] tab)" and input the value indicated by MELFA-Vision.

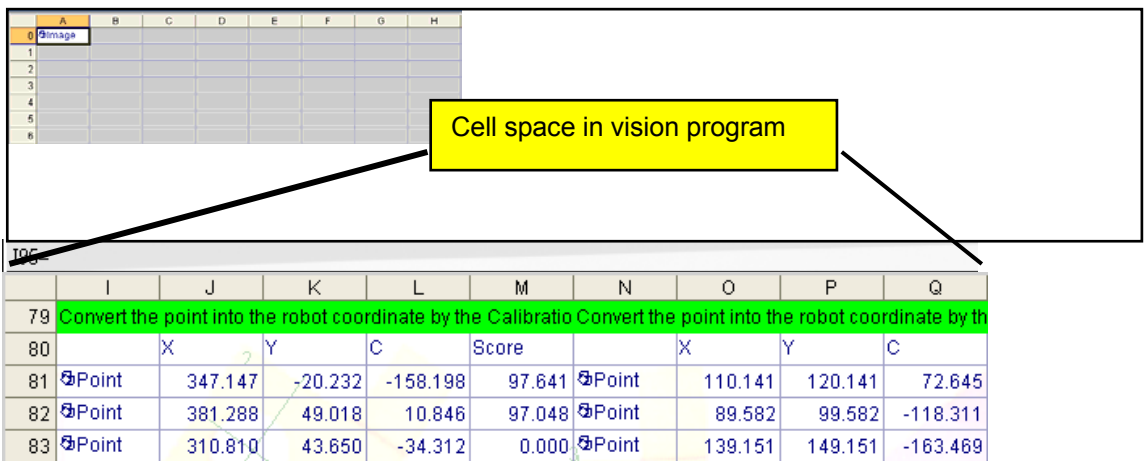

When creating a vision program this way and acquiring the data (X, Y, C) only for Robot 1, specify <Start cell> = "J96" <End cell> = "L98".

- <Type>** (Can not be omitted)  
Specifies the status variable cell in which the results recognized by the vision sensor are stored.  
As a result of the recognition, one cell can store plural data by switching off the comma district.  
However, there is a limitation up to 255 characters or less on one cell.  
The specified character-string data (two or more of one data or the comma district switching off data) preserved from < Start cell > to < End cell > is preserved in a state variable either of character type a positional type variable and a numeric type by the specification of < type >.  
Setting range: 0 – 7 (Set value 4-7 can be used since software version K7.)

9 Detailed Explanation of Functions

About details of a set value, see the " Table 9-2 Preservation specification to state variable by <Type> specified value".

**Table9-2 Preservation specification to state variable by <Type> specified value**

Specified value	0	1	2	3	4	5	6	7
State of cell	1Data/Cell				Two or more of comma(,) district switching off data/Cell			
Correspondence state variable(*1)	P_NVS*()	M_NVS*()	C_NVS*()	M_NVS*() C_NVS*()	P_NVS*()	M_NVS*()	C_NVS*()	M_NVS*() C_NVS*()
Data type	Position type	Single-precision real number type	Text type	Single-precision real number type, Text type	Position type	Single-precision real number type	Text type	Single-precision real number type, Text type

(\*1)\*\*" sign of the correspondence state variable specifies < Vision Sensor Number >.

The Position data P\_NVS\*() is converted into the numerical value for a positional variable and it preserves it in X, Y, and Z coordinates sequentially.  
 When the character which cannot be converted is included, it preserves it as "0".  
 Moreover, the data preserved in the row since the fourth row in cell which specifies it for < Start cell > and < End cell > must not be acquired.

The Numeric type data M\_NVS\*() is converted into the numerical value for a numeric variable and it preserves it.  
 When the character which cannot be converted is included, it preserves it as "0".  
 M\_NVS\*() is two dimension array, and all the data specified for < Start cell > and < End cell > can be preserved.  
 It explains the content by "Explanation".

The Text type dataC\_NVS\*() is preserved as it is for the character type variable.  
 It replies from the Vision Sensor the function and kanji code etc. of the vision program as "#"  
 character.  
 Moreover, it replies by the NULL character for a blank cell.  
 All these situations are preserved in C\_NVS\*() as NULL character.  
 C\_NVS\*() is two dimension array, and all the data specified for < Start cell > and < End cell > can be preserved.

The example of storing information up to 255 characters or less in one cell by switching off the comma district is shown as follows.

	I	J	K	L	M	N	O	P	Q	
91		336.4328,-71.143379,122.274216,344.100983,151.541656,-5.776062,224.575745,274.841492,31.23642,0.0,								

When "4" is specified in the <Type> in this example, "J91" is specified for the <Start cell>, and "J91" is specified for the <End cell>, the following result is obtained.

Variable	Data(X,Y,Z,A,B,C,L1,L2)
P_NVS1(1)	(+336.43,-71.14,+0.00,+0.00,+0.00,+122.27,+0.00+0.00)
P_NVS1(2)	(+344.10,+151.54,+0.00,+0.00,+0.00,-5.78,+0.00+0.00)
P_NVS1(3)	(+224.58,+274.84,+0.00,+0.00,+0.00,+31.24,+0.00+0.00)
P_NVS1(4)	(+0.00,+0.00,+0.00,+0.00,+0.00,+0.00,+0.00+0.00)
.....	.....

<Time out> (If omitted, 10)  
 Specifies the time-out time (in seconds).  
 Specification range: Integer 1-32767

[Sample sentence]

```

100 IF M_NVOPEN(1)<>1 THEN 'If vision sensor number 1 log on is not complete
110   NVOPEN "COM2:" AS #1 'Connects with the vision sensor connected to COM2.
120 ENDIF
130 WAIT M_NVOPEN(1)=1      ' Connects with vision sensor number 1 and waits for logon to be
completed.
140 NVPST #1,"TEST","E76","J81","L84",1,10
'Starts the "Test" program, receives the recognition count from the E76 cell and the recognition results
from cells J81 through L84, and stores this in M_NVSV1 ().
150 'Processes referencing the acquired data.
160 ....
300 NVCLOSE #1 'Cuts the line with the vision sensor connected to COM2.
    
```

[Explanation]

- 1) Starts the specified vision program on the specified vision sensor and receives the results.
- 2) Within the timeout time, does not move to the next step until the results are received from the vision sensor. However, if the robot program is stopped, this command is immediately cancelled. Processing is continued with a restart.
- 3) If the specified <vision program name> is already loaded, processing is executed without loading the program, so the processing time is shortened.
- 4) When this command is used with multi-tasking, it is necessary to execute the NVOPEN command in the task using this command. Also, use the <vision sensor number> specified with the NVOPEN command.
- 5) When type from "4" to "7" is specified for <Type>, the improvement of the data receiving speed from the Vision Sensor can be expected.

A specified position of <Start Cell> and <End Cell> is different depending on a specified value of <Type>, and refer to "Job Editing" Screen - "Result Cell Position" Tab of MELFA-Vision for a specified position.

- 6) A program start condition of "Always" and the continue function are not supported.
- 7) When multi-mechanism mode is used, specified the <Start cell> and <End cell> to acquire information for the number of robots used and specify a type from "1" to "3".

Example: Handling of vision sensor information on only one mult-mechanism mode

	I	J	K	L	M	N	O	P	Q	R
79	Convert the point into the robot coordinate by the Calibration									
80	X	Y	C	Score		X	Y	C	Score	
81	Point	347.147	-20.232	-158.198	97.641	Point	110.141	120.141	72.645	97.641
82	Point	381.289	49.017	10.844	97.224	Point	89.585	99.585	-118.313	97.224
83	Point	310.810	43.649	-34.313	96.217	Point	139.151	149.151	-163.470	96.217

When as in the figure above, the information to the first robot is stored in vision program sheet cells <J96> through <M98> and the information to the second robot is stored in cells <O96> through <R98>, <J96> and <M98> are specified as the <Start cell> and <End cell>.

When "1" is specified as the type with the NVPST command, it is stored in M\_NVSV1() as follows.

Column Row	1	2	3	4	5	6	7	8	9	
M_NVSV1()	1	347.147	-20.232	-158.198	97.641	0.0	0.0	0.0	0.0	0.0
	2	381.288	49.018	10.846	97.048	0.0	0.0	0.0	0.0	0.0
	3	310.81	43.65	-34.312	0.0	0.0	0.0	0.0	0.0	0.0
	4	0.0	0.0	0.0	0.0	0.0	0	0	0	0
	5	0.0	0.0	0.0	0.0	0.0	0	0	0	0

9 Detailed Explanation of Functions

Example: Handling of vision sensor information on two multi-mechanism mode  
 <J96> and <R98> are specified as the <Start cell> and <End cell>.

When "1" is specified as the type with the NVPST command, it is stored in M\_NVSI(30,10) as follows.

Column	1	2	3	4	5	6	7	8	9	
Row										
M_NVSI(10)	1	347.147	-20.232	-158.198	97.641	0.0	110.141	120.141	72.645	97.641
	2	381.288	49.018	10.846	97.048	0.0	89.582	99.582	-118.311	97.048
	3	310.81	43.65	-34.312	0.0	0.0	139.151	149.151	-163.469	95.793
	4	0.0	0.0	0.0	0.0	0.0	0.0	0.0	0.0	0.0
	5	0.0	0.0	0.0	0.0	0.0	0.0	0.0	0.0	0.0

- 8) Up to three robots can control the same vision sensor at the same time, but this command can not be used by more than one robot at the same time. Use this command on any one of the robots.

**[Example of tracking system with three robots and one vision sensor]**

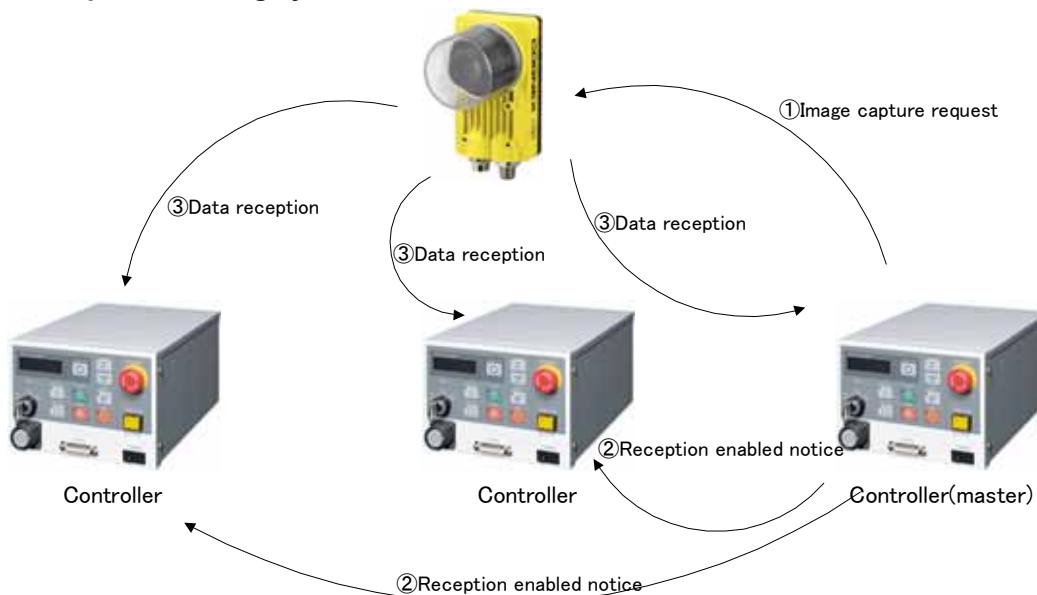

<Procedure>

- ①Of the three robots, one is set as the master and the controller (master) outputs the "image capture request" to the vision sensor with the NVPST command. The vision sensor starts the image capture and when it is complete, returns that to the controller (master).
- ②The controller (master) outputs the "reception enabled notice" to the other two robots. (Taking cost and degree of difficulty into account, we recommend to connect between robots with I/O. The other robots are connected with Ethernet, so interactive notification with text string transmission/reception is possible.)
- ③The respective robots receive the information they respectively require with NVIN commands.

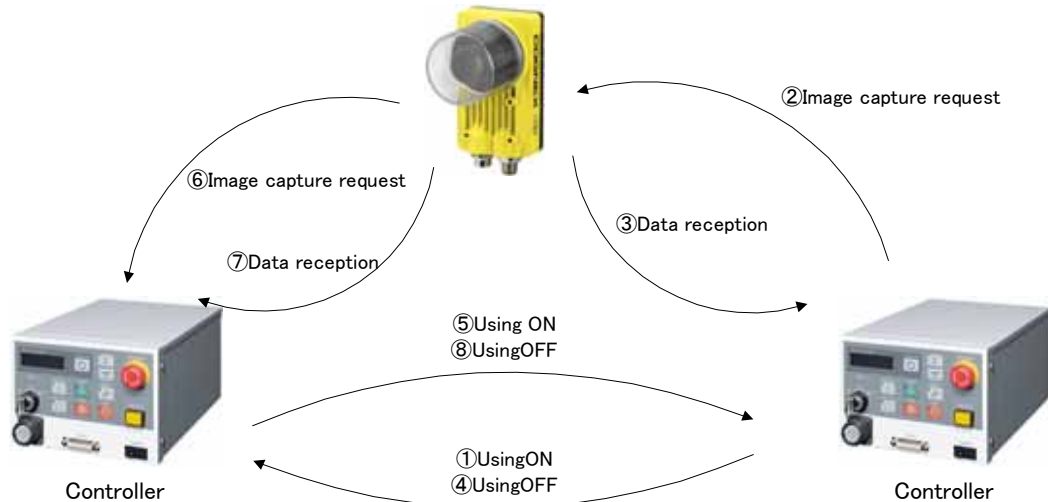
**[Example assembling system with two robots and one vision sensor]**

## &lt;Procedure&gt;

- ①The controller using the vision sensor checks that the vision sensor is not being used by another controller and outputs the "Using" On signal to that controller.
  - ②It outputs the "Image capture request" to the vision sensor.
  - ③When the vision sensor image processing is complete, the controller receives the necessary data.
  - ④The controller switches Off the "Using" signal it had output to the other controller.
  - ⑤The other controller executes Steps 1 - 4.
- In this way, the two robot controllers use the vision sensor alternating or as necessary.
- 9) If an interrupt condition is established while this command is being executed, the interrupt processing is executed immediately.

## [Errors]

- 1) If the data type for an argument is incorrect, a **"syntax error in input command statement"** error is generated.
- 2) If there is an abnormal number of command arguments (too many or too few), an **"incorrect argument count"** error occurs.
- 3) If the <vision sensor number> is anything other than "1" through "8", an **"argument out of range"** error occurs.
- 4) If the NVOOPEN command is not opened with the number specified as the <vision sensor number>, an **"abnormal vision sensor number specification"** error occurs.
- 5) If the <vision program name> exceeds 15 characters, an **"abnormal vision program name"** error occurs.
- 6) If a <vision program name> uses a character other than "0" - "9", "A" - "Z", "-", or "\_" (including lowercase letters), an **"abnormal vision program name"** error occurs.
- 7) If the program specified in the <vision program name> is not in the vision sensor, a **"vision program not present"** error occurs.
- 8) If the <Recognition count cell>, <Start cell>, or <End cell> contains a number other than "0" - "399" or a letter other than "A" - "Z", an **"argument out of range"** error occurs.
- 9) If there is no value in the cell specified in "Recognition count cell", an **"incorrect value in recognition count cell"** error occurs.
- 10) If the <Start cell> and <End cell> are reversed, a **"specified cell value out of range"** error occurs.
- 11) If the number of data included in the cell which specifies it by <Start cell> and <End cell> exceeds 90, a **"specified cell value out of range"** error occurs.
- 12) If the range specified by <Start cell> and <End cell> exceeds line 30 and row 10, a **"specified cell value out of range"** error occurs.
- 13) If the <Type> is other than "0" - "7", an **"argument out of range"** error occurs.
- 14) If the <Timeout> is other than "1" - "32767", an **"argument out of range"** error occurs.
- 15) If the vision sensor does not respond without the time specified as the <Timeout> or within the first 10 seconds if the <Timeout> parameter is omitted, a **"vision sensor response timeout"** error occurs.
- 16) If the vision program's image capture specification is set to anything other than "Camera" (all trigger command), "External trigger", or "Manual trigger", an **"abnormal image capture specification"** error occurs.
- 17) If the vision sensor is "offline", the **"Put online"** error occurs, so put the vision sensor "Online".
- 18) If the communications line is cut while this command is being executed, an **"abnormal communications"** error occurs and the robot controller side line is closed.

### (3) **NVLOAD (network vision sensor load)**

**[Function]**

Loads the specified vision program into the vision sensor.

**[Format]**

NVLOAD #<Vision sensor number>,"<Vision program (job) name>"
--

**[Term]**

**<Vision sensor number>** (Can not be omitted)

This specifies the number of the vision sensor to control.

Setting range: 1 - 8

**<Vision program (job) name>** (Can not be omitted)

Specifies the name of the vision program to start.

The vision program extension (.job) can be omitted.

The only characters that can be used are "0" - "9", "A" - "Z", "a" - "z", "-", and "\_".

**[Sample sentence]**

```
100 IF M_NVOPEN(1)<>1 THEN 'If vision sensor number 1 log on is not complete
110   NVOPEN "COM2:" AS #1 'Connects with the vision sensor connected to COM2.
120 ENDIF
130 WAIT M_NVOPEN(1)=1      ' Connects with vision sensor number 1 and waits for logon to be
    completed.
140 NVLOAD #1,"TEST"        'Loads the "Test".
150 NVPST #1, "", "E76", "J81", "L84", 0, 10
    'Receives the recognition count recognized with the "Test" program from the E76 cell and the
    recognition results from cells J81 through L84, and stores them in P_NVS1().
160 ....
300 NVCLOSE #1 'Cuts the line with the vision sensor connected to COM2.
```

**[Explanation]**

- 1) Loads the specified vision program into the specified vision sensor.
- 2) This command moves to the next step at the point in time when the vision program is loaded into the vision sensor.
- 3) If the program is cancelled while this command is being executed, it stops immediately.
- 4) If the specified <vision program name> is already loaded, the command ends with no processing.
- 5) When this command is used with multi-tasking, it is necessary to execute the NVOPEN command in the task using this command. Also, use the <vision sensor number> specified with the NVOPEN command.
- 6) A program start condition of "Always" and the continue function are not supported.
- 7) If an interrupt condition is established while this command is being executed, the interrupt processing is executed immediately.

**[Errors]**

- 1) If data type for an argument is incorrect, a **"syntax error in input command statement"** error is generated.
- 2) If there is an abnormal number of command arguments (too many or too few), an **"incorrect argument count"** error occurs.
- 3) If the <vision sensor number> is anything other than "1" through "8", an **"argument out of range"** error occurs.
- 4) If the NVOPEN command is not opened with the number specified as the <vision sensor number>, an **"abnormal vision sensor number specification"** error occurs.
- 5) If the <vision program name> exceeds 15 characters, an **"abnormal vision program name"** error occurs.
- 6) If a <vision program name> uses a character other than "0" – "9", "A" – "Z", "-", or "\_" (including lowercase letters), an **"abnormal vision program name"** error occurs.
- 7) If the program specified in the <vision program name> is not in the vision sensor, a **"vision program does not exist"** error occurs.
- 8) If the vision sensor is "offline", the **"Put online"** error occurs, so put the vision sensor "Online".
- 9) If the communications line is cut while this command is being executed, an **"abnormal communications"** error occurs and the robot controller side line is closed.

**(4) NVTRG (network vision sensor trigger)****[Function]**

Requests the specified vision program to capture an image.

**[Format]**

```
NVTRG □ #<Vision sensor number>, <delay time>, <encoder 1 value read-out variable>
                                     [, [<encoder 2 read-out variable>], [<encoder 3 value read-out variable>]
                                     [, [<encoder 4 read-out variable>], [<encoder 5 value read-out variable>]
                                     [, [<encoder 6 read-out variable>], [<encoder 7 value read-out variable>]
                                     [, [<encoder 8 read-out variable>]
```

**[Term]****<Vision sensor number>** (Can not be omitted)

This specifies the number of the vision sensor to control.

Setting range: 1 - 8

**<Delay time>** (Can not be omitted)

This specifies the delay time (in ms) from when the image capture request is output to the vision sensor until the encoder value is obtained.

Setting range: 0 - 150 ms

**<Encoder n value read-out variable>** (Can be omitted from the second one on)

Specifies the double precision numeric variable into which the read out external encoder n value is set.

Note: n is 1 - 8.

**[Sample sentence]**

```
100 IF M_NVOPEN(1)<>1 THEN 'If vision sensor number 1 logon is not complete
110   NVOPEN "COM2:" AS #1 'Connects with the vision sensor connected to COM2.
120 ENDIF
130 WAIT M_NVOPEN(1)=1      ' Connects with vision sensor number 1 and waits for logon to be
    completed.
140 NVRUN #1,"TEST"        'Starts the "Test" program.
150 NVTRG #1,15,M1#,M2#    'Requests the vision sensor to capture an image and acquires encoders
    1 and 2 after 15 ms.
160 NVIN #1, "TEST", "E76", "J81", "L84", 0, 10
    'Receives the recognition count recognized with the "Test" program from the E76 cell and the
    recognition results from cells J81 through L84, and stores this in P_NVS1 (.).
170 ....
300 NVCLOSE #1            'Cuts the line with the vision sensor connected to COM2.
```

**[Explanation]**

- 1) Outputs the image capture request to the specified vision sensor and acquires the encoder value after the specified time. The acquired encoder value is stored in the specified numeric variable.
- 2) This command moves to the next step at the point in time when the encoder value is acquired the specified time after the image capture request to the vision sensor.
- 3) If the program is cancelled while this command is being executed, it stops immediately.
- 4) For receiving data from the vision sensor, use the NVIN command.
- 5) When this command is used with multi-tasking, it is necessary to execute the NVOPEN command in the task using this command. Also, use the <vision sensor number> specified with the NVOPEN command.
- 6) A program start condition of "Always" and the continue function are not supported.
- 7) Up to three robots can control the same vision sensor at the same time, but this command can not be used by more than one robot at the same time. Use this command on any one of the robots.
- 8) If an interrupt condition is established while this command is being executed, the interrupt processing is executed immediately.

[Errors]

- (1) If data type for an argument is incorrect, a **"syntax error in input command statement"** error is generated.
- (2) If there is an abnormal number of command arguments (too many or too few), an **"incorrect argument count"** error occurs.
- (3) If the <vision sensor number> is anything other than "1" through "8", an **"argument out of range"** error occurs.
- (4) If the NVOPEN command is not opened with the number specified as the <vision sensor number>, an **"abnormal vision sensor number specification"** error occurs.
- (5) If the vision program's image capture specification is set to anything other than "Camera" (all trigger command), "External trigger", or "Manual trigger", an **"abnormal image capture specification"** error occurs.
- (6) If the vision sensor is "offline", the **"Put online"** error occurs, so put the vision sensor "Online".
- (7) If the communications line is cut while this command is being executed, an **"abnormal communications"** error occurs and the robot controller side line is closed.



**(5) NVRUN (network vision sensor run)****[Function]**

Starts the specified vision program.

**[Format]**

```
NVRUN □ #<Vision sensor number>,"<Vision program (job) name>"
```

**[Term]**

**<Vision sensor number>** (Can not be omitted)

This specifies the number of the vision sensor to control.

Setting range: 1 - 8

**<Vision program (job) name>** (Can not be omitted)

Specifies the name of the vision program to start.

The vision program extension (.job) can be omitted.

The only characters that can be used are "0" - "9", "A" - "Z", "a" - "z", "-", and "\_".

**[Sample sentence]**

```
100 IF M_NVOPEN(1)<>1 THEN 'If vision sensor number 1 log on is not complete
110   NVOPEN "COM2:" AS #1 'Connects with the vision sensor connected to COM2.
120 ENDIF
130 WAIT M_NVOPEN(1)=1      ' Connects with vision sensor number 1 and waits for logon to be
    completed.
140 NVRUN #1,"TEST"         'Starts the "Test" program.
150 NVIN #1,"TEST","E76","J81","L84",0,10
    'Receives the recognition count recognized with the "Test" program from the E76 cell and the
    recognition results from cells J81 through L84, and stores this in P_NVS1 (30).
160 ....
300 NVCLOSE #1 'Cuts the line with the vision sensor connected to COM2.
```

**[Explanation]**

- 1) Starts the specified vision program in the specified vision sensor.
- 2) This command moves to the next step after it has verified that the vision sensor has received the image capture and image processing command.
- 3) If the program is cancelled while this command is being executed, it stops immediately.
- 4) If the specified <vision program name> is already loaded, only image capture and image processing are executed. (The vision program is not loaded.)
- 5) For receiving data from the vision sensor, use the NVIN command.
- 6) When this command is used with multi-tasking, it is necessary to execute the NVOPEN command in the task using this command. Also, use the <vision sensor number> specified with the NVOPEN command.
- 7) A program start condition of "Always" and the continue function are not supported.
- 8) When multi-mechanism mode is used and data for multiple robots is required, make a vision program that creates data for multiple robots with one image capture request.

**Example**

I95=		I	J	K	L	M	N	O	P	Q	R
79		Convert the point into the robot coordinate by the Calibration					Convert the point into the robot coordinate by the Calibration				
80		X	Y	C	Score	X	Y	C	Score		
81	Point	347.147	-20.232	-158.198	97.641	Point	110.141	120.141	72.645	97.641	
82	Point	381.289	49.017	10.844	97.224	Point	89.585	99.585	-118.313	97.224	
83	Point	310.810	43.649	-34.313	96.217	Point	139.151	149.151	-163.470	96.217	

- 9) Up to three robots can control the same vision sensor at the same time, but this command can not be used by more than one robot at the same time. Use this command on any one of the robots.
- 10) If an interrupt condition is established while this command is being executed, the interrupt processing is executed immediately.

[Errors]

- 1) If data type for an argument is incorrect, a **"syntax error in input command statement"** error is generated.
- 2) If there is an abnormal number of command arguments (too many or too few), an **"incorrect argument count"** error occurs.
- 3) If the <vision sensor number> is anything other than "1" through "8", an **"argument out of range"** error occurs.
- 4) If the NVOOPEN command is not opened with the number specified as the <vision sensor number>, an **"abnormal vision sensor number specification"** error occurs.
- 5) If the <vision program name> exceeds 15 characters, an **"abnormal vision program name"** error occurs.
- 6) If a <vision program name> uses a character other than "0" – "9", "A" – "Z", "-", or "\_" (including lowercase letters), an **"abnormal vision program name"** error occurs.
- 7) If the program specified in the <vision program name> is not in the vision sensor, a **"vision program not present"** error occurs.
- 8) If the vision program's image capture specification is set to anything other than "Camera" (all trigger command), "External trigger", or "Manual trigger", an **"abnormal image capture specification"** error occurs.
- 9) If the vision sensor is "offline", the **"Put online"** error occurs, so put the vision sensor "Online".
- 10) If the communications line is cut while this command is being executed, an **"abnormal communications"** error occurs and the robot controller side line is closed.

**(6) NVIN (network vision sensor input)****[Function]**

Receives the results of the recognition by the vision sensor.  
The data received from the vision sensor is stored in the robot controller robot status variables.

**[Format]**

NVIN□#<Vision sensor number>,[<Vision program (job) name]  
, <Recognition count cell>,<Start cell>,<End cell>,<Type> [,<Timeout>]

**[Term]****<Vision sensor number>** (Can not be omitted)

This specifies the number of the vision sensor to control.

Setting range: 1 - 8

**<Vision program (job) name>** (Can not be omitted)

Specifies the name of the vision program to obtain the recognition results of.

If this parameter is omitted, the results are obtained from the currently active vision program.

The vision program extension (.job) can be omitted.

The only characters that can be used are "0" - "9", "A" - "Z", "a" - "z", "-", and "\_".

**<Recognition count>** (Can not be omitted)

Specifies the cell in which the count of work recognized by the vision sensor is stored.

Setting range: Row: 0-399 Column: "A" - "Z" Example: "A5"

\* When a vision program is created with MELFA-Vision, input the value specified by MELFA-Vision is input.

**<Start cell>/<End cell>** (Can not be omitted)

Specifies the cell range in which the results recognized by the vision sensor are stored.

The contents of the specified cell are stored in any of the status variables P\_NVS\*()EM\_NVS\*()EC\_NVS\*().

(\* = 1 - 8)

Setting range: Row: 0-399 Column: "A" - "Z" Example: "A5", "C10", etc.

\* When a vision program is created with MELFA-Vision, input the value specified by MELFA-Vision.

**<Type>** (Can not be omitted)

Specifies the status variable cell in which the results recognized by the vision sensor are stored.

Setting range: 0 - 7 (Set value 4-7 can be used since software version K7.)

Refer to the explanation of NVPST for the content of the processing of a specified value.

**<Time out>** (If omitted, 10)

Specifies the time-out time (in seconds).

Specification range: Integer 1-32767

**[Sample sentence]**

```
100 IF M_NVOPEN(1)<>1 THEN 'If vision sensor number 1 log on is not complete
110   NVOPEN "COM2:" AS #1 'Connects with the vision sensor connected to COM2.
120 ENDIF
130 WAIT M_NVOPEN(1)=1      ' Connects with vision sensor number 1 and waits for logon to be
    completed.
140 NVRUN #1,"TEST"         'Starts the "Test" program.
150 NVIN #1, "TEST","E76","J81","L84",0,10
    'Receives the recognition count recognized with the "Test" program from the E76 cell and the
    recognition results from cells J81 through L84, and stores this in P_NVS1 (30).
160 .....
300 NVCLOSE #1             'Cuts the line with the vision sensor connected to COM2.
```

[Explanation]

- 1) Receives the recognition results from the specified vision program of the specified vision sensor.
- 2) Within the timeout time, does not move to the next step until the results are received from the vision sensor.  
However, if the robot program is stopped, this command is cancelled. Processing is executed from the cancelled state with a restart.
- 3) When this command is used with multi-tasking, it is necessary to execute the NVOOPEN command and NVRUN command in the task using this command. At this time, use the <vision sensor number> specified with the NVOOPEN command.
- 4) When type from "4" to "7" is specified for <Type>, the improvement of the data receiving speed from the Vision Sensor can be expected.  
A specified position of <Start Cell> and <End Cell> is different depending on a specified value of <Type>, and refer to "Job Editing" Screen - "Result Cell Position" Tab of MELFA-Vision for a specified position.
- 5) A program start condition of "Always" and the continue function are not supported.
- 6) When using multi-mechanism mode, see the explanation of the NVPST command.
- 7) Up to three robots can control the same vision sensor at the same time, but this command can not be used by more than one robot at the same time. Use this command on any one of the robots.
- 8) If an interrupt condition is established while this command is being executed, the interrupt processing is executed immediately. Processing is executed when the interrupt processing ends or is continued with a restart.
- 9) When this command is executed, it is necessary to specify beforehand with the NVPST command or NVRUN command the vision program specified with the <Vision program name>.
- 10) In order to shorten the tact time, it is possible to do other work after executing the NVRUN command and execute NVIN when it is required.
- 11) Note that if the program stops between NVRUN and NVIN, the results when NVRUN is executed and the results when NVIN is executed may be different.

[Errors]

- 1) If the data type for an argument is incorrect, a **"syntax error in input command statement"** error is generated.
- 2) If there is an abnormal number of command arguments (too many or too few), an **"incorrect argument count"** error occurs.
- 3) If the <vision sensor number> is anything other than "1" through "8", an **"argument out of range"** error occurs.
- 4) If the NVOOPEN command is not opened with the number specified as the <vision sensor number>, an **"abnormal vision sensor number specification"** error occurs.
- 5) If the <vision program name> exceeds 15 characters, an "abnormal vision program name" error occurs.
- 6) If a <vision program name> uses a character other than "0" – "9", "A" – "Z", "-", or "\_" (including lowercase letters), an "abnormal vision program name" error occurs.
- 7) If the program specified in the <vision program name> is not in the vision sensor, a **"vision program does not exist"** error occurs.
- 8) If the program specified in the <vision program name> is not started by an NVRUN command, a **"abnormal vision program name"** error occurs.
- 9) If the <Recognition count cell>, <Start cell>, or <End cell> contains a number other than "0" – "399" or a letter other than "A" – "Z", an **"argument out of range"** error occurs.
- 10) If there is no value in the cell specified in "Recognition count cell", an **"invalid value in specified for recognition count cell"** error occurs.
- 11) If the number of data included in the cell which specifies it by <Start cell> and <End cell> exceeds 90, a **"specified cell value out of range"** error occurs.
- 12) If the range specified by <Star cell> and <End cell> exceeds line 30 and row 10, a **"specified cell value out of range"** error occurs.
- 13) If the <Type> is other than "0" - "7", an **"argument out of range"** error occurs.
- 14) If the <Start cell> and <End cell> are reversed, a **"specified cell value out of range"** error occurs.
- 15) If the <Type> is other than "0" – "3", an **"argument out of range"** error occurs.
- 16) If the <Timeout> is other than "1" – "32767", an **"argument out of range"** error occurs.
- 17) If the vision sensor does not respond without the time specified as the <Timeout> or within the first 10 seconds if the <Timeout> parameter is omitted, a **"vision sensor response timeout"** error occurs.
- 18) If the communications line is cut while this command is being executed, an **"abnormal communications"** error occurs and the robot controller side line is closed.

**(7) NVCLOSE (network vision sensor line close)****[Function]**

Cuts the line with the specified vision sensor.

**[Format]**

```
NVCLOSE □ [[#]<Vision sensor number>[, [[#]<Vision sensor number>···]]
```

**[Term]**

**<Vision sensor number>** (Can be omitted)

Specifies a constant from 1 to 8 (the vision sensor number). Indicates the number for the vision sensor connection to the COM specified with the <COM number>.

When this parameter is omitted, all the lines (vision sensor lines) opened with an NVOOPEN command are closed.

Also, up to 8 <vision sensor numbers> can be specified. They are delimited with commas.

Setting range: 1 - 8

**[Sample sentence]**

```
100 IF M_NVOOPEN(1)<>1 THEN' When logon has not been completed for vision sensor number 1
110   NVOOPEN "COM2:" AS #1 ' Connects with the vision sensor connected to COM2 and sets its number
as number 1.
120 ENDIF
130 WAIT M_NVOOPEN(1)=1   ' Connects with vision sensor number 1 and waits for logon to be
completed.
140 .....
300 NVCLOSE #1           'Cuts the line with the vision sensor connected to COM2.
```

**[Explanation]**

- 1) Cuts the line with the vision sensor connected with the NVOOPEN command.
- 2) If the <vision sensor number> is omitted, cuts the line with all the vision sensors.
- 3) If a line is already cut, execution shifts to the next step.
- 4) Because up to seven vision sensors can be connected at the same time, <Vision sensor numbers> are used in order to identify which vision sensor to close the line for.
- 5) If the program is cancelled while this command is being executed, execution continues until processing of this command is complete.
- 6) When this command is used with multi-tasking, in the task using this command, it is necessary to close only the lines opened by executing an NVOOPEN command . At this time, use the <Vision sensor number> specified with the NVOOPEN command.
- 7) A program start condition of "Always" and the continue function are not supported.
- 8) If an END command is used, all the lines opened with an NVOOPEN command or OPEN command are closed. However, lines are not closed with an End command in a program called out with a CALLP command.  
Lines are also closed by a program reset, so when an END command or a program reset is executed, it is not necessary to close lines with this command.
- 9) The continue function is not supported.
- 10) If an interrupt condition is established while this command is being executed, the interrupt processing is executed after this command is completed.

**[Errors]**

- 1) If the value specified as the <vision sensor number> is anything other than "1" through "8", the **"argument out of range"** error occurs.
- 2) If there are more than eight command arguments, an **"incorrect argument count"** error occurs.

### 9.1.3. Robot status variables

Here are the status variables for vision sensors.

Be careful. The data for these status variables is not backed up by the RT ToolBox backup function. These status variables can be used on Ver.K6 or later of robot controller's software versions .

**Table 9-3 Vision Sensor Status Variable List**

Variable name	Array elements	Contents	Attribute (*)	Data type
M_NVOPEN	8	Line connection status	R	Integer type
M_NVNUM	8	Vision sensor work detection count	R	Integer type
P_NVSV*(*=1 - 8)	30	Vision sensor detection data	R	Position type
M_NVSV*(*=1 - 8)	30, 10		R	Single-precision real number type
C_NVSV*(*=1 - 8)	30, 10		R	Text type

(\*1) R indicates that a status variable is read-only.

The details of the status variables are as follows.

#### (1) M\_NVOPEN

[Function]

Indicates the vision sensor line connection status.

[Array meaning]

Array elements (1 - 8): Vision sensor numbers

[Explanation of values returned]

0: Line connecting (logon not complete)    1: Logon complete    -1: Not connected

[Usage]

After an NVOPEN command is executed, checks whether or not the line with the vision sensor is connected and the vision sensor logged onto.

[Sample sentence]

```

100 IF M_NVOPEN(1)<>1 THEN ' If vision sensor number 1 is not connected
110   NVOPEN "COM2:" AS #1 ' Connects with the vision sensor connected to COM2 and sets its
   number as number 1.
120 ENDIF
130 WAIT M_NVOPEN(1)=1     ' Connects with vision sensor number 1 and waits for the logon state.
140 .....
300 NVCLOSE #1            'Cuts the line with the vision sensor connected to COM2.

```

[Explanation]

- 1) Indicates the status of a line connected with a network vision sensor with an NVOPEN command when the line is opened.
- 2) The initial value is "-1". At the point in time that the NVOPEN command is executed and the line is connected, the value becomes "0" (line connecting). At the point in time that the network vision sensor logon is completed, the value becomes "1" (logon complete).
- 3) This variable strongly resembles the status of status variable M\_OPEN, but whereas M\_OPEN becomes "1" when the connection is verified, M\_NVOPEN becomes "1" when the vision sensor logon is complete.

[Errors]

- (1) If the type of data specified as an array element is incorrect, a **"syntax error in input command statement"** error occurs.
- (2) If there is an abnormal number of array elements (too many or too few), an **"incorrect argument type"** error occurs.
- (3) If an array element other than "1" through "8" is specified, an **"array element mistake"** error occurs.

**(2) M\_NVNUM****[Function]**

Indicates the number of pieces of work detected by the vision sensor.

**[Array meaning]**

Array elements (1 - 8): Vision sensor numbers

**[Explanation of values returned]**

Work detection count (0-255)

**[Explanation]**

- 1) Indicates the number of pieces of work detected by the vision sensor with the NVPST command or NVIN command.
- 2) The stored recognition count is held until the next NVPST command or NVIN command is executed. When an NVPST command or NVIN command is executed, the data is cleared to "0".
- 3) When the <Recognition count cell> specified with the NVPST command or NVIN command is a blank cell in the vision program or a vision program command is specified, this becomes "0".

**[Sample sentence]**

```

100 IF M_NVOPEN(1)<>1 THEN ' When logon has not been completed for vision sensor number 1
110   NVOPEN "COM2:" AS #1 ' Connects with the vision sensor connected to COM2.
120 ENDIF
130 WAIT M_NVOPEN(1)=1      ' Connects with vision sensor number 1 and waits for logon to be
    completed.
140 NVPST #1,"TEST","E76","J81","L84",1,10
    'Starts the "Test" program, receives the recognition count from the E76 cell and the recognition results
    from cells J81 through L84, and stores this in M_NV51().
150 'Processes referencing the acquired data.
160 MVCNT=M_NVNUM(1)       'Acquires the number of pieces of work recognized by the vision sensor.
170 .....
300 NVCLOSE #1             'Cuts the line with the vision sensor connected to COM2.

```

**[Errors]**

- 1) If the type of data specified as an array element is incorrect, a **"syntax error in input command statement"** error occurs.
- 2) If there is an abnormal number of array elements (too many or too few), an **"incorrect argument type"** error occurs.
- 3) If an array element other than "1" through "8" is specified, an **"array element mistake"** error occurs.

### (3) P\_NVS1 - P\_NVS8

[Function]

Stores the data recognized by the vision sensor in position data format.

In an NVPST command or NVIN command, when a <type> of "0" is specified, the data in the cell range specified with <Start cell> - <End cell> is stored as the X, Y, and C coordinates.

In an NVPST command or NVIN command, data must be stored in the order X, Y, C in the cells specified with <Start cell> - <End cell>.

Example:

I95=	I	J	K	L	M	N	O	P	Q	R
79	Convert the point into the robot coordinate by the Calibratio									
80		X	Y	C	Score		X	Y	C	Score
81	Point	347.147	-20.232	-158.198	97.641	Point	110.141	120.141	72.645	97.641
82	Point	381.289	49.017	10.844	97.224	Point	89.585	99.585	-118.313	97.224
83	Point	310.810	43.649	-34.313	96.217	Point	139.151	149.151	-163.470	96.217

In the above vision program, when "J96" and "L98" are specified in the <Start cell> and <End cell> of the NVPST command or NVIN command, P\_NVS1() becomes the following values.

P\_NVS1(1)=(+347.14 , -20.23 , +0.00 , +0.00 , +0.00 , -158.19 , +0.00 , +0.00)(0 , 0)  
 P\_NVS1(2)=(+381.28 , +49.01 , +0.00 , +0.00 , +0.00 , +10.84 , +0.00 , +0.00)(0 , 0)  
 P\_NVS1(3)=(+310.81 , +43.65 , +0.00 , +0.00 , +0.00 , -34.312 , +0.00 , +0.00)(0 , 0)  
 P\_NVS1(4)=( +0.00 , +0.00 , +0.00 , +0.00 , +0.00 , +0.00 , +0.00 , +0.00)(0 , 0)  
 P\_NVS1(5)=( +0.00 , +0.00 , +0.00 , +0.00 , +0.00 , +0.00 , +0.00 , +0.00)(0 , 0)  
 .....  
 P\_NVS1(30)=( +0.00 , +0.00 , +0.00 , +0.00 , +0.00 , +0.00 , +0.00 , +0.00)(0 , 0)

[Array element count]: 30

The maximum number of pieces of work that a vision sensor can recognize at one time is 255, but the maximum number of sets of work information that a robot can acquire is 30.

[Sample sentence]

```

100 IF M_NVOPEN(1)<>1 THEN 'If vision sensor number 1 log on is not complete
110   NVOPEN "COM2:" AS #1 'Connects with the vision sensor connected to COM2.
120 ENDIF
130 WAIT M_NVOPEN(1)=1      ' Connects with vision sensor number 1 and waits for logon to be
    completed.
140 NVPST #1,"TEST","E76","J96","L98",0,10
    'Starts the "Test" program, receives the recognition count from the E76 cell and the recognition results
    from cells J96 through L98, and stores this in P_NVS1().
150 MVCNT=M_NVNUM(1)        'Acquires the number of pieces of work recognized by the vision sensor.
330 FOR MCNT=1 TO MVCNT     'Repeated once for each piece of work recognized
340   P10=P1                 'Copies the reference position P1 to target position P10.
350   P10=P10*P_NVS1(MCNT) 'Corrects the difference from the reference work for the recognized work
    and substitutes it in P10.
360   MOV P10,-50           'Moves to above the first recognized piece of work.
370   MVS P10               'Moves to the position of the first recognized piece of work.
380   HCLOSE 1              'Grasps the work.
390   MVS P10,-50           'Moves to above the first recognized piece of work
400 NEXT MCNT
    
```



## [Explanation]

- 1) In an NVPST command or NVIN command, when a <type> of "0" is specified, the data recognized by the vision sensor is stored in position data format.
- 2) When this variable is used, write the vision program to store the data in the order X, Y, and C.

Example:

I96=										
	I	J	K	L	M	N	O	P	Q	R
79	Convert the point into the robot coordinate by the Calibration Convert the point into the robot coordinate by the Calibration									
80		X	Y	C	Score		X	Y	C	Score
81	Point	347.147	-20.232	-158.198	97.641	Point	110.141	120.141	72.645	97.641
82	Point	381.289	49.017	10.844	97.224	Point	89.585	99.585	-118.313	97.224
83	Point	310.810	43.649	-34.313	96.217	Point	139.151	149.151	-163.470	96.217

- 3) The stored data is held until the next NVPST command or NVIN command is executed. However, this data is cleared by a program reset, END command, or power supply reset. Even if the continue function is enabled, the data is cleared (to 0 for all axes) for a power supply reset.
- 4) Also, if anything other than "0" is specified as the type with the NVPST command or NVIN command, all axes are cleared to "0".
- 5) If the acquired data is a vision program function or character string, "0" is stored in the corresponding axis.
- 6) The data for this variable is the valid position data for 8 axes.
- 7) When using multi-mechanism mode, see the explanation of the NVPST command.

## [Errors]

- 1) If the type of data specified as an array element is incorrect, a **"syntax error in input command statement"** error occurs.
- 2) If there is an abnormal number of array elements (too many or too few), an **"incorrect argument type"** error occurs.
- 3) If an array element other than "1" through "30" is specified, an **"array element mistake"** error occurs.

### (4) M\_NVSI - M\_NVSI8

[Function]

Stores the data recognized by the vision sensor in numeric data format. In an NVPST command or NVIN command, when a <type> of "1" or "3" or "5" or "7" is specified, the data in the cell range specified with <Start cell> - <End cell> is converted into numbers and stored.

Example:

I95=											
	I	J	K	L	M	N	O	P	Q	R	
79	Convert the point into the robot coordinate by the Calibration										
80		X	Y	C	Score		X	Y	C	Score	
81	Point	347.147	-20.232	-158.198	97.641	Point	110.141	120.141	72.645	97.641	
82	Point	381.289	49.017	10.844	97.224	Point	89.585	99.585	-118.313	97.224	
83	Point	310.810	43.649	-34.313	96.217	Point	139.151	149.151	-163.470	96.217	

In the above vision program, when "J96" and "Q98" are specified in the <Start cell> and <End cell> of the NVPST command or NVIN command, the value of M\_NVSI() becomes the following values.

Element 2										
Element 1		1	2	3	4	5	6	7	8	9
M_NVSI()	1	347.147	-20.232	-158.198	97.641	0.0	110.141	120.141	72.645	0.0
	2	381.288	49.018	10.846	97.048	0.0	89.582	99.582	-118.311	0.0
	3	310.81	43.65	-34.312	0.0	0.0	139.151	149.151	-163.469	0.0
	4	0.0	0.0	0.0	0.0	0.0	0.0	0.0	0.0	0.0
	5	0.0	0.0	0.0	0.0	0.0	0.0	0.0	0.0	0.0

[Array element count]: (30.10)

It is possible to acquire 30 lines and 10 columns of information from all the cell information in the vision program.

[Sample sentence]

```

100 IF M_NVOPEN(1)<>1 THEN 'If vision sensor number 1 log on is not complete
110   NVOPEN "COM2:" AS #1 ' Connects with the vision sensor connected to COM2 and sets its
    number as number 1.
120 ENDIF
130 WAIT M_NVOPEN(1)=1      ' Connects with vision sensor number 1 and waits for logon to be
    completed.
140 NVPST #1,"TEST","E76","J96","Q98"0.1,10
    'Starts the "Test" program, receives the recognition count from the E76 cell and the recognition results
    from cells J96 through Q98, and stores this in M_NVSI().
150 MVCNT=M_NVNUM(1)       'Acquires the number of pieces of work recognized by the vision
    sensor.
330 FOR MCNT=1 TO MVCNT    'Repeated once for each piece of work recognized
340   P10=P1               'Copies the reference position P1 to target position P10.
340   P10.X=M_NVSI(MCNT,1) 'Substitutes the X coordinate of the recognized work in the X
    coordinate of P1.
350   P10.Y=M_NVSI(MCNT,2) 'Substitutes the Y coordinate of the recognized work in the Y
    coordinate of P1.
360   P10.C=M_NVSI(MCNT,3) 'Substitutes the C coordinate of the recognized work in the C
    coordinate of P1.
370   MOV P10,-50          'Moves to above the first recognized piece of work
380   MVS P10              'Moves to the position of the first recognized piece of work
390   HCLOSE 1             'Grasps the work.
400   MVS P10,-50         'Moves to above the first recognized piece of work
410 NEXT MCNT
    
```

[Explanation]

- 1) In an NVPST command or NVIN command, when a <type> of "1" or "3" or "5" or "7" is specified, the data recognized by the vision sensor is stored in numeric data format.
- 2) The stored data is held until the next NVPST command or NVIN command is executed. However, this data is cleared (to 0) by a program reset, END command, or power supply reset. Also, if anything other than "1" and "3" and "5" and "7" is specified as the type with the NVPST command or NVIN command, the data is cleared to "0".
- 3) If the acquired data is a vision program function or character string, "0" is stored in the corresponding axis.
- 4) When using multi-mechanism mode, see the explanation of the NVPST command.

[Errors]

- 1) If the type of data specified as an array element is incorrect, a **"syntax error in input command statement"** error occurs.
- 2) If there is an abnormal number of array elements (too many or too few), an **"incorrect argument type"** error occurs.
- 3) If an array element 1 specification specifies other than "1" through "30", an **"array element mistake"** error occurs.
- 4) If an array element 2 other than "1" through "10" is specified, an **"array element mistake"** error occurs.

### (5) C\_NVS1 - C\_NVS8

[Function]

Stores the data recognized by the vision sensor in text string data format.

In an NVPST command or NVIN command, when a <type> of "2" or "3" or "6" or "7" is specified, the data in the cell range specified with <Start cell> - <End cell> is stored.

Example:

	I	J	K	L	M	N	O	P	Q	R
79	Convert the point into the robot coordinate by the Calibration									
80		X	Y	C	Score		X	Y	C	Score
81	Point	347.147	-20.232	-158.198	97.641	Point	110.141	120.141	72.645	97.641
82	Point	381.289	49.017	10.844	97.224	Point	89.585	99.585	-118.313	97.224
83	Point	310.810	43.649	-34.313	96.217	Point	139.151	149.151	-163.470	96.217

In the above vision program, when "J95" and "Q98" are specified in the <Start cell> and <End cell> of the NVPST command or NVIN command, the value of C\_NVS1() becomes the following values.

Element 2 Element 1	1	2	3	4	5	6	7	8	9	
C_NVS1()	1	"X"	"Y"	"C"	"Score"	"	"X"	"Y"	"C"	"Score"
	2	"347.147"	"-20.232"	"-158.198"	"97.641"	"	"110.141"	"120.141"	"72.645"	"97.641"
	3	"381.289"	"49.017"	"10.844"	"97.227"	"	"89.585"	"99.585"	"-118.313"	"97.227"
	4	"310.81"	"43.649"	"-34.313"	"96.217"	"	"139.151"	"149.151"	"-163.47"	"96.217"
	5	"	"	"	"	"	"	"	"	"

[Array element count]: (30.10)

It is possible to acquire 30 lines and 10 columns of information from all the cell information in the vision program.

[Sample sentence]

```

10 DIM MSCORE(100) 'Declares the variable for storing scores.
100 IF M_NVOPEN(1)<>1 THEN ' When logon has not been completed for vision sensor number 1
110 NVOPEN "COM2:" AS #1 ' Connects with the vision sensor connected to COM2 and sets its
number as number 1.
120 ENDIF
130 WAIT M_NVOPEN(1)=1 ' Connects with vision sensor number 1 and waits for logon to be
completed.
140 NVPST #1,"TEST","E76","J95","Q98",3,10
' Starts the "Test" program, receives the recognition count from the E76 cell and the recognition results from
cells J95 through Q98, and stores this in C_NVS1(1,1) - and M_NVS1(1,1) - .
150 MVCNT=M_NVNUM(1) 'Acquires the number of pieces of work recognized by the vision sensor.
160 FOR MCNT2=1 TO 8
170 IF C_NVS1(1,MCNT2)="Score" THEN BREAK
180 NEXT MCNT2
300 FOR MCNT1=1 TO MVCNT
'Repeated once for each piece of work recognized
310 MSCORE(MCNT1)=VAL(C_NVS1(MCNT1+1,MCNT2)) ' Stores the score for the recognized work into
MSCORE
320 NEXT MCNT1
330 MOK=0 ' Clears MOK
330 FOR MCNT=1 TO MVCNT 'Repeated once for each piece of work recognized
340 IF MSCORE(MCNT)>90 THEN MOK=MOK+1 'If the score is 90 points or higher, adds 1 to MOK.
350 NEXT MCNT
360 ' Checks the value of MOK and checks the number of pieces of work for which the score is 90 points or
higher.
    
```

## [Explanation]

- 1) In an NVPST command or NVIN command, when a <type> of "2" or "3" or "6" or "7" is specified, the data recognized by the vision sensor is stored in text string format. However, kanji codes can not be acquired.
- 2) The maximum number of pieces of work that a vision sensor can recognize at one time is 255, but the maximum number of sets of work information that a robot can acquire is 30.
- 3) The stored data is held until the next NVPST command or NVIN command is executed. However, this data is cleared by a program reset, END command, or power supply reset. Also, if anything other than "2" and "3" and "6" and "7" is specified as the type with the NVPST command or NVIN command, the data is cleared to null.
- 4) If the acquired data is a vision program function or kanji code, a null character is stored in the corresponding axis.
- 5) When using multi-mechanism mode, see the explanation of the NVPST command.

## [Errors]

- 1) If the type of data specified as an array element is incorrect, a **"syntax error in input command statement"** error occurs.
- 2) If there is an abnormal number of array elements (too many or too few), an **"incorrect argument type"** error occurs.
- 3) If an array element 1 other than "1" through "30" is specified, an **"array element mistake"** error occurs.
- 4) If an array element 2 other than "1" through "10" is specified, an **"array element mistake"** error occurs.

## 9. 2. MELFA-Vision Function Details

This section explains MELFA-Vision functions other than those explained in "Chapter 5 - 0.

### 9. 2. 1. MELFA-Vision Main Screen

For explanations concerning the MELFA-Vision main screen, see "6.3.1 Starting MELFA-Vision (network vision sensor support software)".

Figure 9-1 MELFA-Vision Main Screen

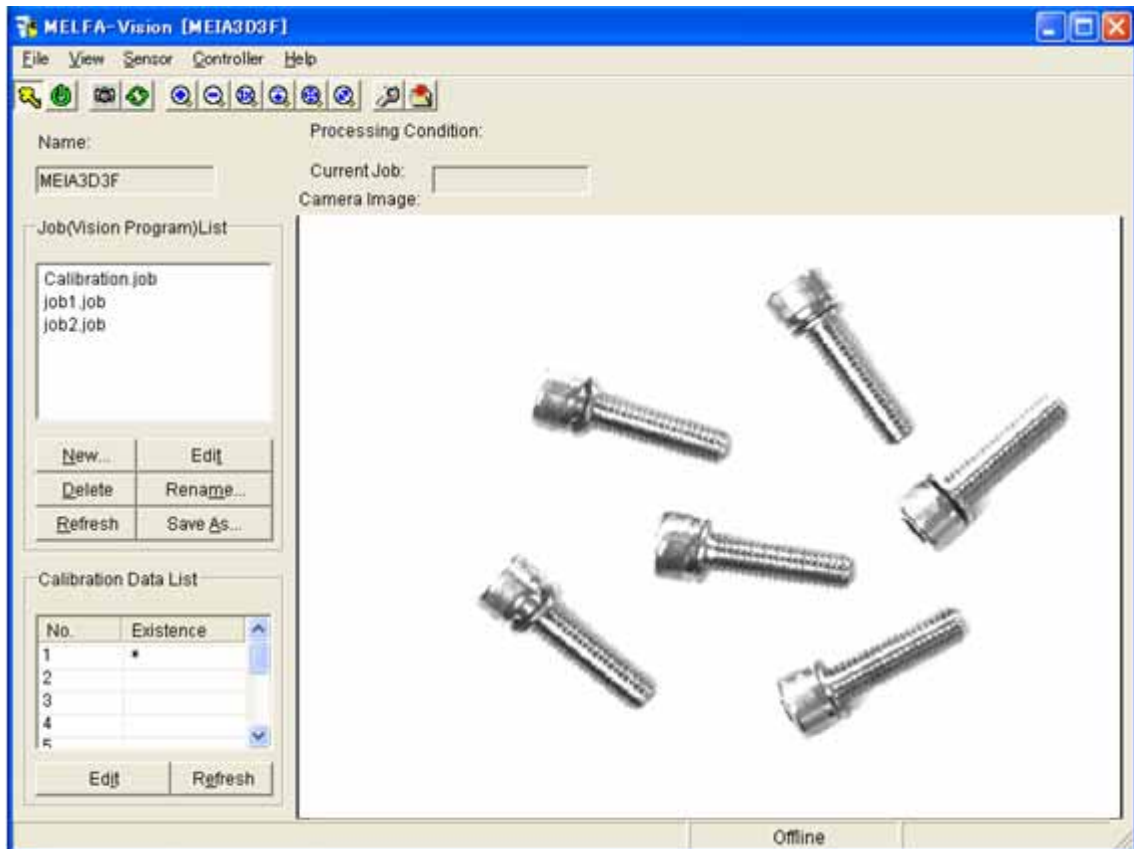

### 9.2.2. Job Editing screen ([Image Log] tab)

On the job edit screen [Image Log] tab, the conditions are set for the PC in which the images captured with the vision sensor are stored to the PC. It is necessary to start the FTP server on the PC storing the images. For explanations concerning the MELFA-Vision main screen, see "8.4 Image Log Acquisition Settings and Reception Start/End".

This section explains the conditions set with the [Image Log] tab.

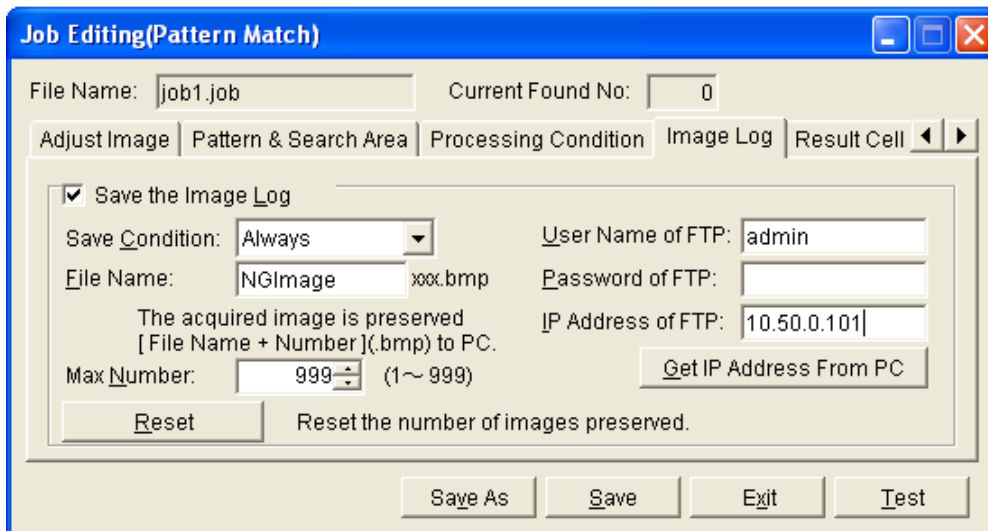

Figure 9-2 Job Edit Screen [Image Log] Tab

Table 9-4 Job Edit Screen [Image Log] Tab Setting Item List

Setting item	Explanation
Save the Image Log	To acquire the image log, put a check in the [Save the Image Log] checkbox. To not acquire the image log, remove the check from the checkbox.
Save Condition	Sets the condition for storing images captured with the vision sensor to the PC. Always : All images captured with the vision sensor are stored OK images : The image is stored if the count of recognized pieces of work is not 0. NG images : The image is stored if the count of recognized pieces of work is 0.
File Name	Images captured with the vision sensor are stored as bit map (bmp) files on the PC. This specifies the file name. * Up to 50 files names can be specified.
Max Number	This specifies the number of images stored on the PC. Serial numbers up to specified number of images are attached after the file name. Example: When the file name is "NGImage" "NGImage001.bmp", "NGImage002.bmp"... "NGImage010.bmp"... If the specified number of images is exceeded, the serial number is reset and already stored bmp files are overwritten.
Reset	This resets the serial numbers attached to the file name. The file name for the image captured after resetting becomes "file name 001.bmp".
User Name of FTP (*1)	Specifies the FTP server user name set with the displayed "Image Log Setting" screen.
Password of FTP (*1)	Specifies the FTP server password set with the displayed "Image Log Setting" screen.
IP Address of FTP	Specifies the IP address of the PC on which the FTP server is running.
Get IP Address From PC	When an MELFA-Vision FTP server is used and this button is clicked, the IP address of the PC MELFA-Vision is running on is displayed in the [IP Address of FTP].

(\*1) For details on the "Image Log Setting" screen, see "8.4 Image Log Acquisition Settings and Reception Start/End".

### 9.2.3. Job edit screen ([Result Cell Position] tab)

The "Job Editing" screen [Result Cell Position] tab displays "Found Number Cell", "Start", and "End" specified with the dedicated MELFA-BASICIV command for the network vision sensor. A cell is a position indicated by the column character and row character in the vision program.

This section explains the cell positions displayed on the screen.

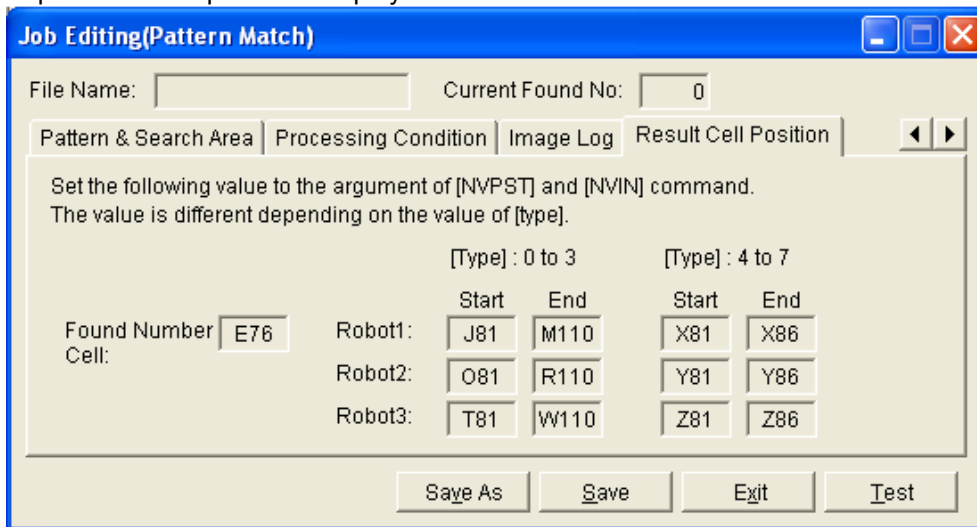

Figure 9-3 Job Editing Screen ([Result Cell Position] Tab)

Table 9-5 Job Editing Screen [Result Cell Position] Tab Display Item List

Setting item	Explanation
Found Number Cell	The number of pieces of work recognized by the vision sensor is stored in the displayed cell position.
Robot 1	The coordinates (robot 1 coordinates) for the work recognized by the vision sensor are stored from the displayed start cell position to the displayed end cell position.
Robot 2 (*1)	The coordinates (robot 2 coordinates) for the work recognized by the vision sensor are stored from the displayed start cell position to the displayed end cell position.
Robot 3 (*2)	The coordinates (robot 3 coordinates) for the work recognized by the vision sensor are stored from the displayed start cell position to the displayed end cell position.
[Type]: 0 to 3	When you specify the range from 0 to 3 for a value of the type of "NVPST" and "NVIN" command of MEFLA-BASIC IV command, the position of the cell which specifies it for A and B is shown.
[Type]: 4 to 7	When you specify the range from 4 to 7 for a value of the type of "NVPST" and "NVIN" command of MEFLA-BASIC IV command, the position of the cell which specifies it for A and B is shown.

(\*1) Displayed when a job for two robots is selected.

(\*2) Displayed when a job for three robots is selected.



### 9.2.4. Vision sensor network settings

The vision sensor network settings can be changed. From the MELFA-Vision menu, click [Sensor] – [Connection] – [Communication Setting] to display the "Network Settings" screen. Check with your network administrator for the items to set.

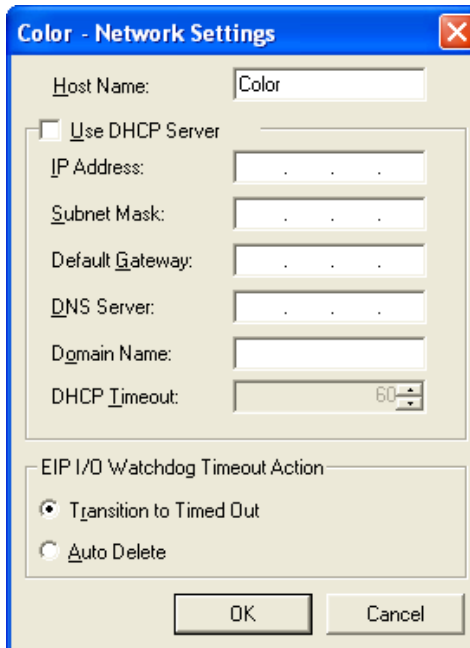

Figure 9-4 MELFA-Vision "Network Settings" Screen

Table 9-6 "Network Settings" Screen Setting Items List

Setting item	Explanation
Host Name	Changes the vision sensor name.
Use DHCP Server	Check this when using the DHCP server to allocate the IP address.
IP Address	Input the IP address.
Subnet Mask	Defines which part of the IP address shows the network and which part shows the host.
Default Gateway	Data can be relayed between hosts on different networks by specifying the gateway address.
DNS Server	Input the network host IP that supplies the DNS resolution (converting from host name to IP address).
Domain Name	Defines the domain name of the network the vision sensor is on.
DHCP Timeout	Specifies the DHCP server response wait time.
Transition to Time Out	Shifts to another connection without closing the connection.
Auto Delete	Closes the connection.

### 9.3. Vision program detailed explanation

MELFA-Vision provides a number of programs (job files) as templates.

This section explains the templates provided.

#### 9.3.1. Templates provided for MELFA-Vision

The table below shows the templates provided for MELFA-Vision.

**Table 9-7 List of Job Templates Provided**

No.	Image processing (*1)	Output coordinates (*4)	Number of robots (*5)	Displayable count (*6)	result		
1	Pattern matching (*2)	Absolute coordinates	1	1			
2				4			
3				10			
4				20			
5				30			
6			2	2	1		
7					4		
8					10		
9					20		
10					30		
11			3	3	1		
12					4		
13					10		
14					20		
15					30		
16			Relative coordinates			1	
17						4	
18						10	
19						20	
20						30	
21	Blob (binarization processing) (*3)	Absolute coordinates	1	1			
22				4			
23				10			
24				20			
25				30			
26	Color(*7)			1			
27				4			
28				10			
29				20			
30				30			

(\*1) Pattern matching, blobs, edges, histograms, ID recognition, text comparison, etc. are provided for vision sensor image processing, but the image processing supported by MELFA-Vision is pattern matching and blobs.

(\*2) Pattern matching is a method of detecting patterns in images based on registered patterns.

(\*3) Blobbing is a method for detecting two-dimensional shape information such as the size, shape, position, linking, etc. of patterns expressed as blobs.

The blob template is effective for the following types of subjects.

- Large subjects
- Subjects whose shapes change irregularly

For details on blob image processing, see "9.3.2 Image processing - blobs".

(\*4) There are two types of output coordinates.

**Table 9-8 List of Coordinates Output to Robot**

Output method	Explanation
Absolute coordinate output	The detected pattern position is output converted to the robot coordinate system.
Relative coordinate output	The detected pattern position is output with the robot coordinate system offset quantities for the relative position based on the registered pattern position.

(\*5) Templates are also provided that secure the data for two robots or for three robots with one image. When multiple robots are connected to one vision sensor, it is possible to acquire the operation positions for each robot by capturing one image.

(\*6) It is necessary for the vision program to prepare beforehand an area in which to store the work position data that the robot acquires. Expanding this area increases the amount of information that the robot can obtain, but also increases the vision program load time and the time for sending the information from the vision sensor to the robot. Therefore, MELFA-Vision provides templates for areas for storing 1/4/10/20/30 sets of work information. Select the one that best matches your system.

These quantities - 1/4/10/20/30 – indicate the maximum number of sets of work data that the robot can acquire. For example, for acquiring 8 sets of work data, select the 10 template.

(\*7) Color is a method to detect the pattern in the image based on the specified color pattern.

Refer to “9.3.3 Image processing – Color” for details of the color image processing.

### 9.3.2. Image processing - blobs

This section explains how to make the blob image processing settings, using pattern matching image processing (only one robot, results output as robot absolute coordinate values) as an example.

- (1) In the [Job(Vision Program)List] on the left side of the main MELFA-Vision screen, click [New]. From the "Image Processing Method" screen displayed, select blob image processing, then click the [OK] button.

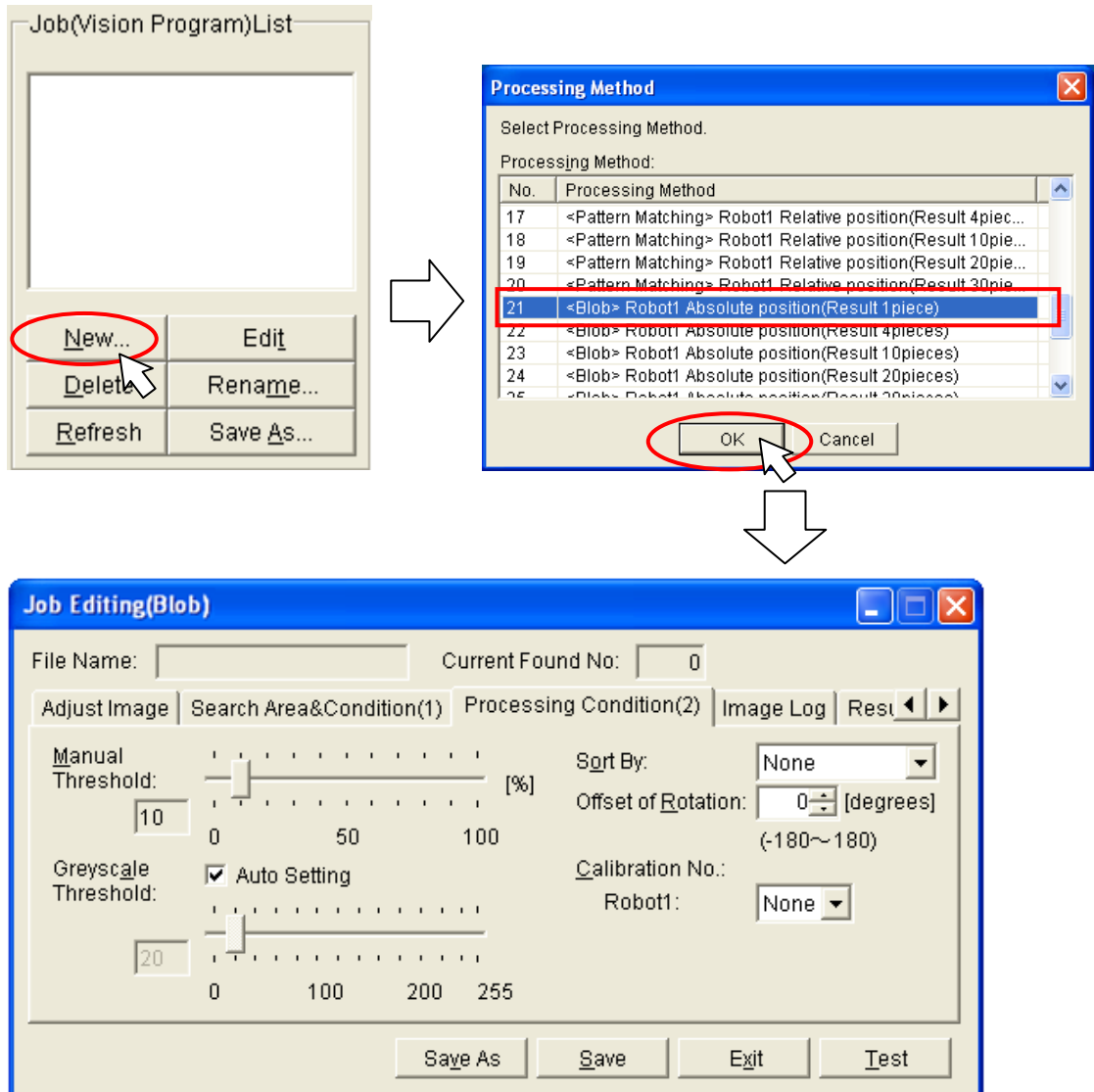
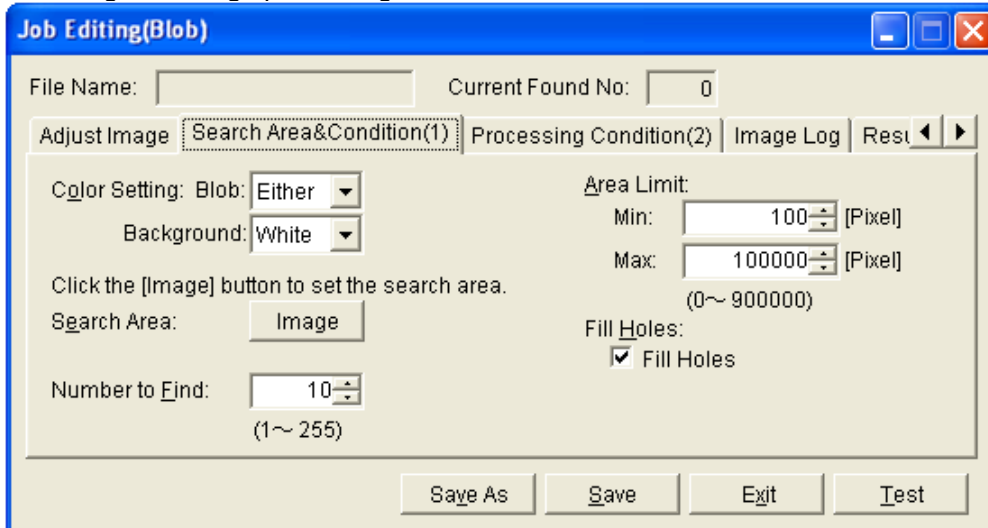

Figure 9-5 Blob Image Processing Selection

- (2) Execute the work in order of the [Adjust Image] Search Area&Condition(1) Processing Condition(2) Image Log Result Cell Position tabs from left to right on the displayed "Job Editing" screen.  
 For details on the [Adjust Image] tab, see "6.3.3 Image processing settings".
- (3) When you click the "Job Editing" screen [Search Area & Condition(1)] tab, the conditions for executing blob image processing are set.



When you change a displayed setting item, then click the [Test] button, the results of image processing under the specified conditions are displayed at the main screen [Camera Image], so check whether or not the work is correctly recognized.  
 For details on the setting items, see "Table 9-9 List of [Search Area and Recognition Condition (1)] Tab Items".

**Table 9-9 List of [Search Area and Recognition Condition (1)] Tab Items**

Setting item		Setting range	Explanation
Color Setting	Blob	Black/white/Either	Select the color of the work to be recognized (black or white or any desired color)
	Background	Black/white	This specifies the color (black or white) that is the background for captured images.
Search Area		—	Click the [Image] button to set the range for detecting the work (blob). For details on the setting method, see "6.3.3 Image processing settings".
Number to Find		1 - 255	This sets the maximum number of pieces that can be detected in one image processing.
Area Limit	Min	0 - 900000	This sets the surface area range (minimum to maximum) for detected work (blobs). This surface area range is specified in pixels.
	Max		
Fill Holes		ON/OFF	When there are holes in the work, to recognize the work in the state with the holes filled, put a check in the [Fill Holes] checkbox. To recognize with holes unfilled, remove the check from the checkbox.

\* For all the items, if a value outside the range is input, it is replaced with the upper or lower limit value near the image going out of focus.

- (4) When you click the "Job Editing" screen [Processing Condition(2)] tab, the conditions for executing blob image processing are set.

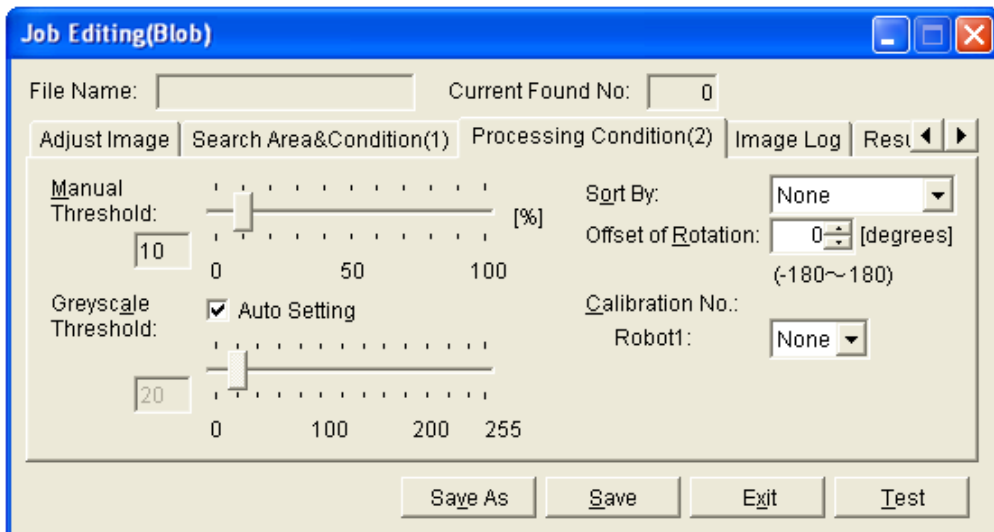

When you change a displayed setting item, then click the [Test] button, the results of image processing under the specified conditions are displayed at the main screen [Camera Image], so check whether or not the work is correctly recognized.

For details on the setting items, see "Table 9-9 List of [Search Area and Recognition Condition (1)] Tab Items".

**Table 9-10 List of [Processing Condition(2)] Tab Items**

Setting item	Setting range	Explanation
Manual Threshold	1 - 100	This sets what degree of recognition is required for recognition of work detected with the threshold specified with the grayscale threshold. For the vision sensor, the degree of matching of the detected work is expressed as 1-100%. Work whose degree of matching is lower than the value set here is not recognized.
Greyscale Threshold	1 - 255	This sets the grayscale threshold. When the "Auto Setting" checkbox is checked, the value is set automatically from the images captured.
Sort By	None X Y	Returns the recognized work results in the specified sort order. When "None" is specified, the results are returned with the work sorted in order of high recognition ratio. This sorting is used for cases such as when multiple work pieces are detected and you want to grasp the work in order from left to right in the image. The "X" and "Y" specified here indicate the "X" and "Y" at the red frame displayed with the search area setting.
Offset of Rotation	-180 - 180	When outputting the recognized work results, this function adds the specified offset amount to the detection angle. When registering patterns, this is used if the 0°-tilt image can not be captured.
Calibration No.	None 1 - 10	This selects the data when outputting the recognized work coordinate value converted to the robot coordinate value. Work information can be converted to the coordinate systems for up to three robots and sent. Therefore, it is possible to select calibration numbers for three robots. * The figure above shows a screen assuming a system with one robot. When a system is selected with three robots, [Robot 2:] and [Robot 3:] display appears.

\* For all the items, if a value outside the range is input, it is replaced with the upper or lower limit value near the image going out of focus.

- (5) For details on the [Image Log] tab, see "9.2.2 Job Editing screen ([Image Log] tab) "; for details on the [Results Cell Position] tab, see "9.2.3 Job edit screen ([Result Cell Position] tab) ".

### 9.3.3. Image processing – Color

This section explains how to make the Color image processing settings, using pattern matching image processing (only one robot, results output as robot absolute coordinate values) as an example.

- (1) In the [Job(Vision Program)List] on the left side of the main MELFA-Vision screen, click [New]. From the "Image Processing Method" screen displayed, select Color image processing, then click the [OK] button.

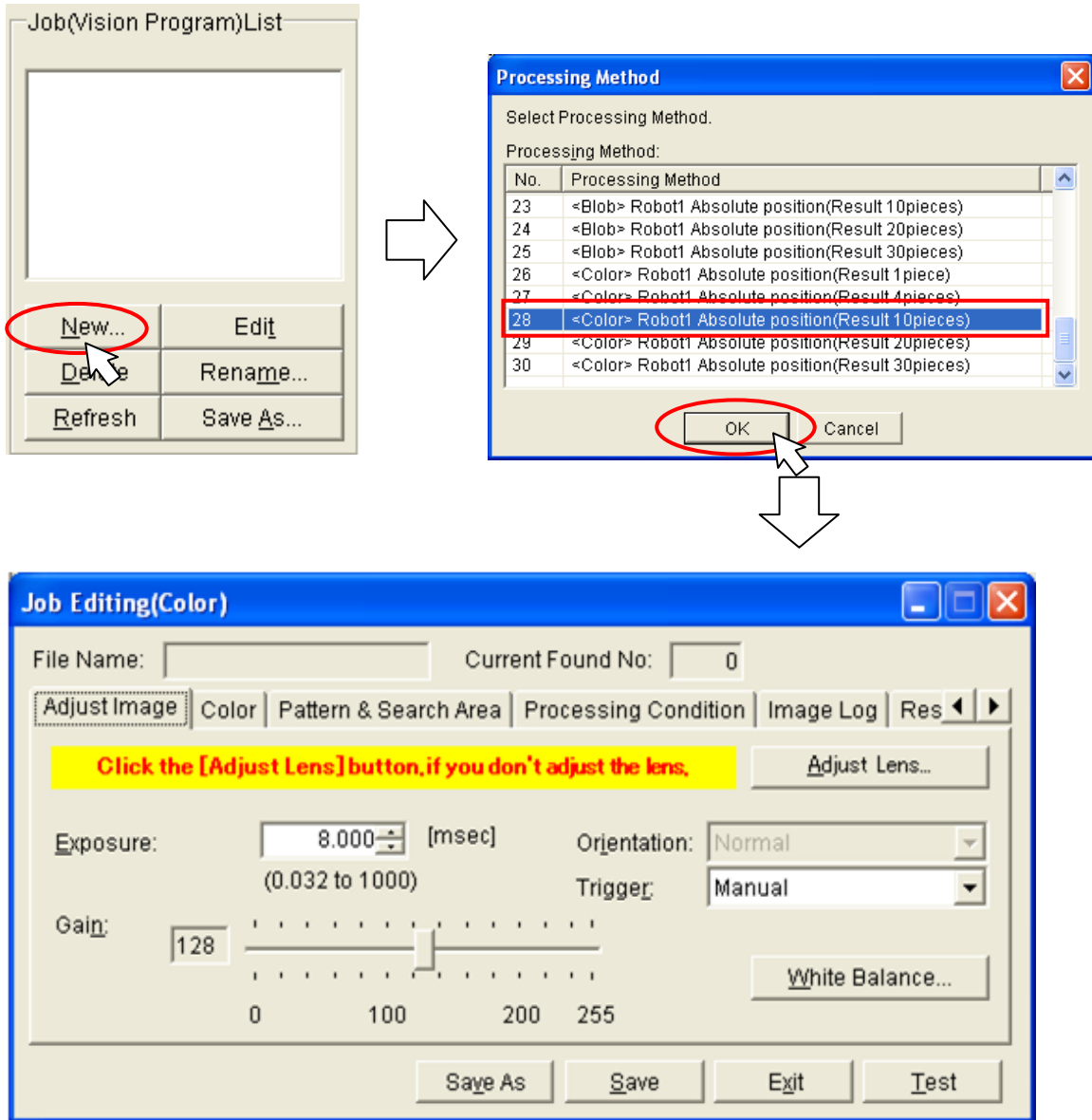

Figure 9-6 Color Image Processing Selection

- (2) Execute the work in order of the Adjust Image Color Pattern & Search Area Processing Condition Image Log Res ◀ ▶ tabs from left to right on the displayed "Job Editing" screen.
- (3) [White Balance] button of [Adjust Image] tab is clicked, and a standard color is specified. [White Balance] button is displayed only in case of the color image processing. The image in the state that the [White Balance] button is not clicked cannot accurately recognize the color like "Figure 9-1 When you do not click [White Balance] button".

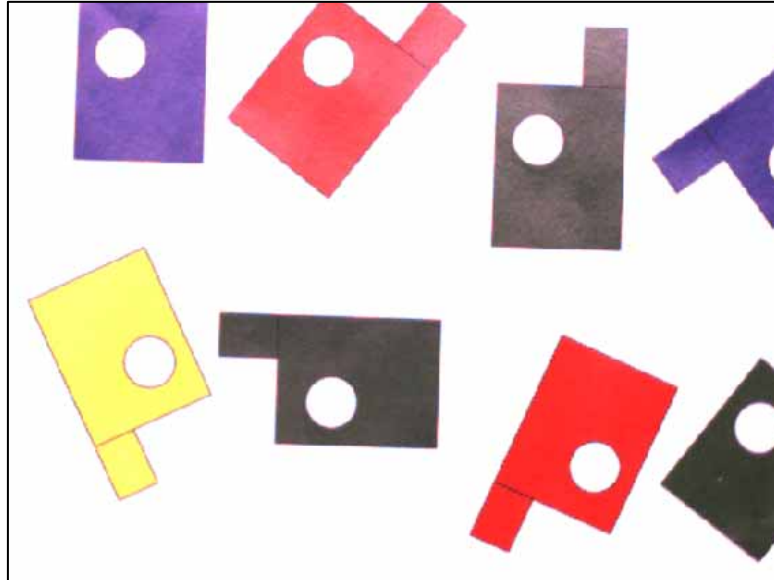

Figure 9-2 When you do not click [White Balance] button

[White Balance] button is clicked, standard color is recognized and the RGBcolor can be recognized more accurately. A standard color is a color of 100\*100 dots at the center of the camera picture when [White Balance] button is clicked. In this case, standard color is made white, it comes to recognize the color by a color near man's recognition.

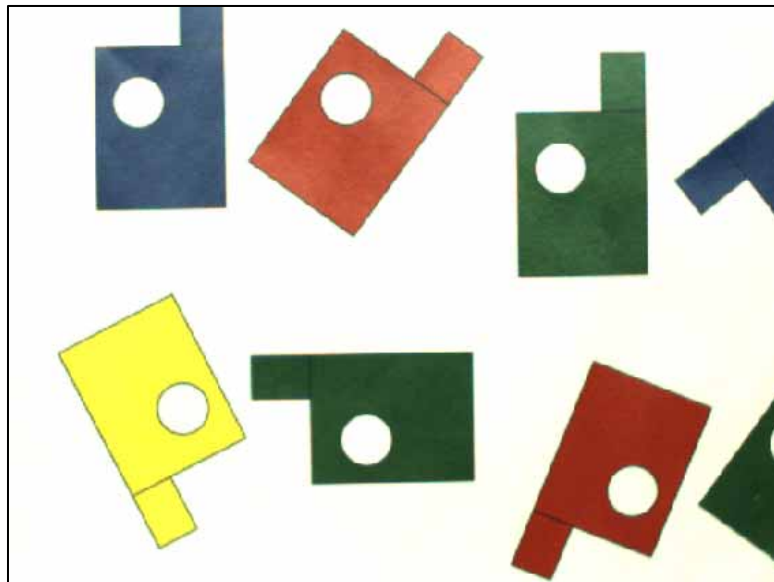
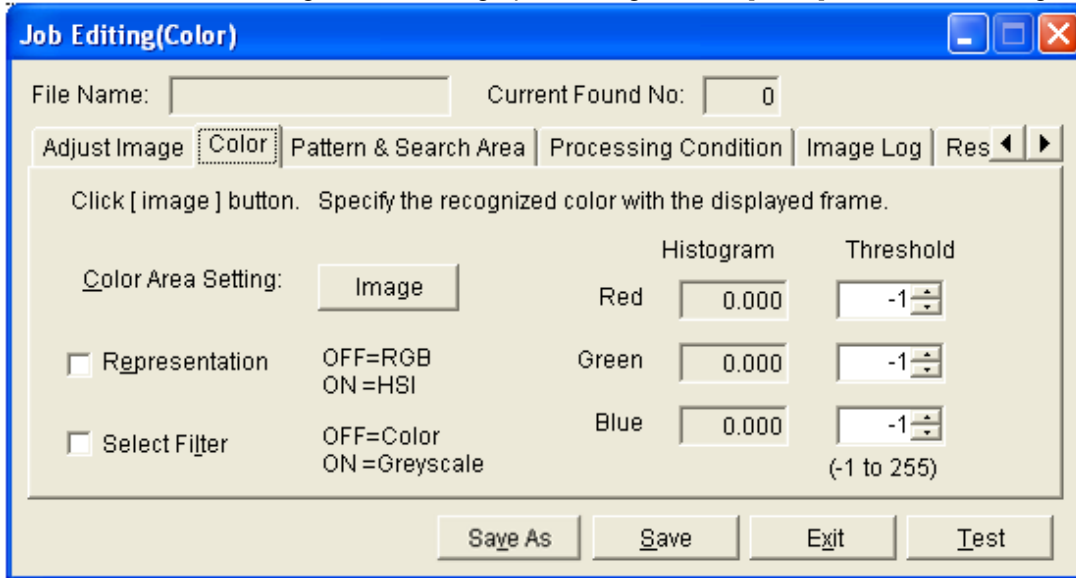

Figure 9-3 When you click [White Balance] button



(4) The condition of executing the color image processing is set in [Color] tab of "Job Editing" screen.



When [Test] button is clicked after the displayed set item is changed, the result of processing the image on [Camera Image] of the main screen and the condition of specifying it is displayed.

Confirm whether the light and shade of work is clear according to the specified color on the screen.

For details on the setting items, see "Table 9-1 List of [Color] Tab Items"

Table 9-2 List of [Color] Tab Items

Setting item	Setting range	Explanation
Color Area Setting	—	[Image] button is clicked, shifts to a graphic image and a square frame is displayed. Enclose the color which wants to be recognized with the frame and click the [Enter] key.
Representation	ON/OFF	Whether the specified color is acquired in RGB(Red/Green/Blue) information or it acquires it in HIS(Hue/Intensity/Saturation) information is selected.
Select Filter	ON/OFF	Whether the image displayed on the screen is displayed by the color or it displays it with grey scale which puts the specified color filter is selected.
Histogram	—	Color specified by [Color Area Setting] information is displayed. When [Representation] CheckBox is OFF, information on RGB is displayed. And the CheckBox is ON, information on HIS is displayed.
Threshold	-1: Auto 0 - 255: Manual	Initial value is "-1". When the value is "-1", the color of work is converted into white putting the color specified by [Color Area Setting] filter. When the light and shade of work is not clear by the self adjustment filter, the color recognize can be adjusted which input the value of 0 - 255 to "Threshold".

(4-1)Color Area Setting is specified.

When [Image] button of "Color Area Setting" is clicked, foci move to the main screen, and Area adjustment mark is displayed in [Camera Image] .

The color which wants to be recognized from the area enclosed with this frame is detected.

Enclose the color which wants to be recognized with the frame.

The area in which the work is detected can be changed with the mouse or keyboard.

If you use the keyboard, each time the [F9] key is pressed, the "area adjustment mark" changes and fine adjustments can be made with the [arrow keys].

To finalize the area, press the [Enter] key; to cancel it, press the [ESC] key.

The focus returns to the "Job Editing" screen.

When press the [Enter] key, color specified for "Histogram" information is displayed.

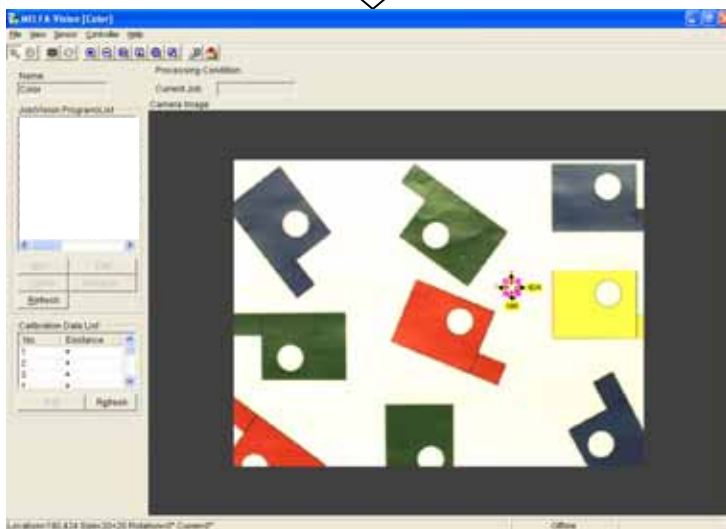
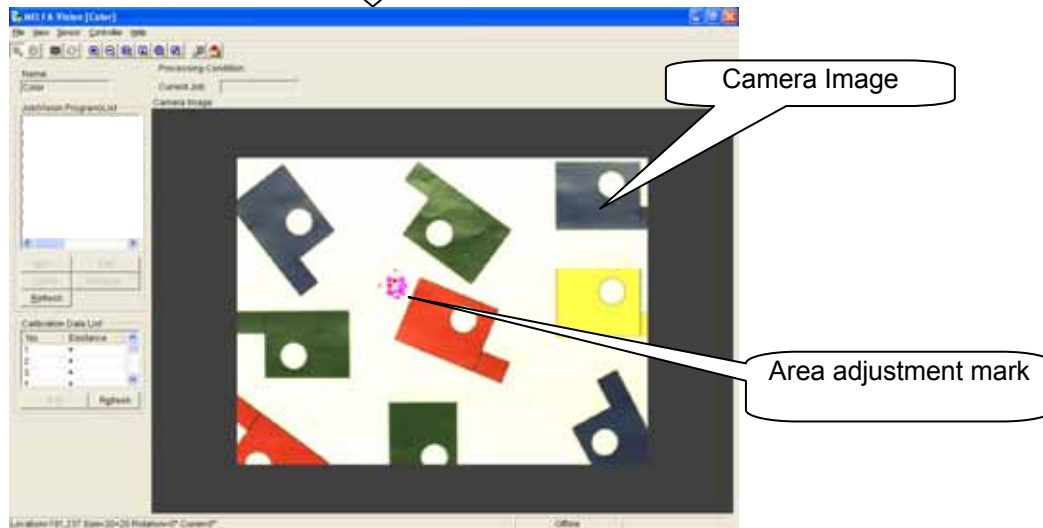
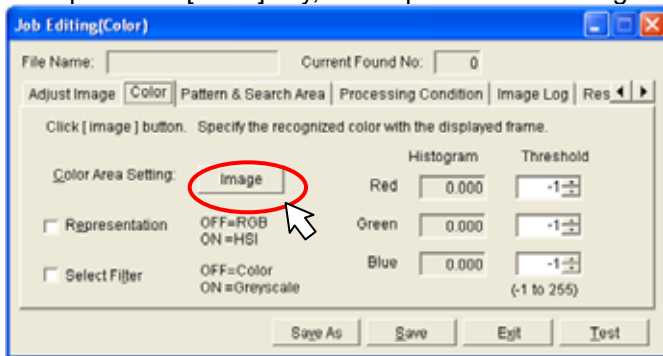

(4-2)Changes to the gray-scale imagery by the color which specifies [Camera Image].  
 [Select Filter] CheckBox is ON, and [Test] button is clicked.  
 Specified color is displayed in white putting the same filter as the specified color.

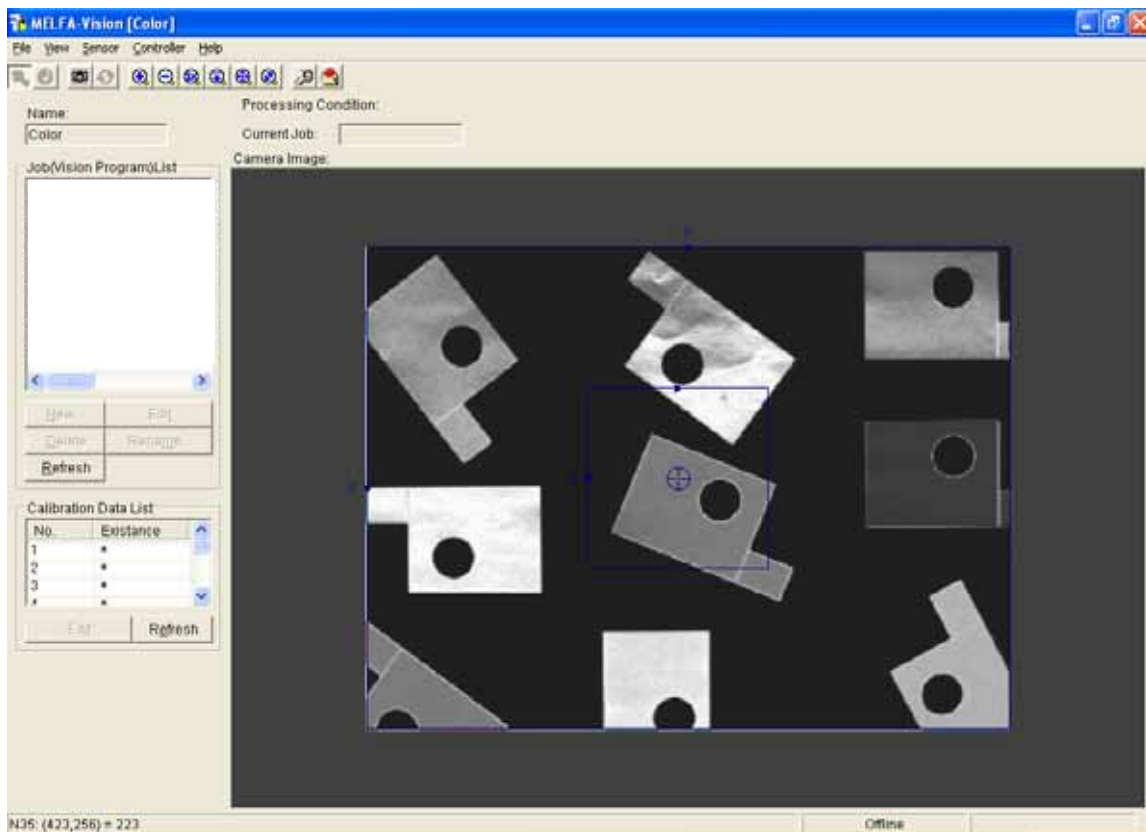
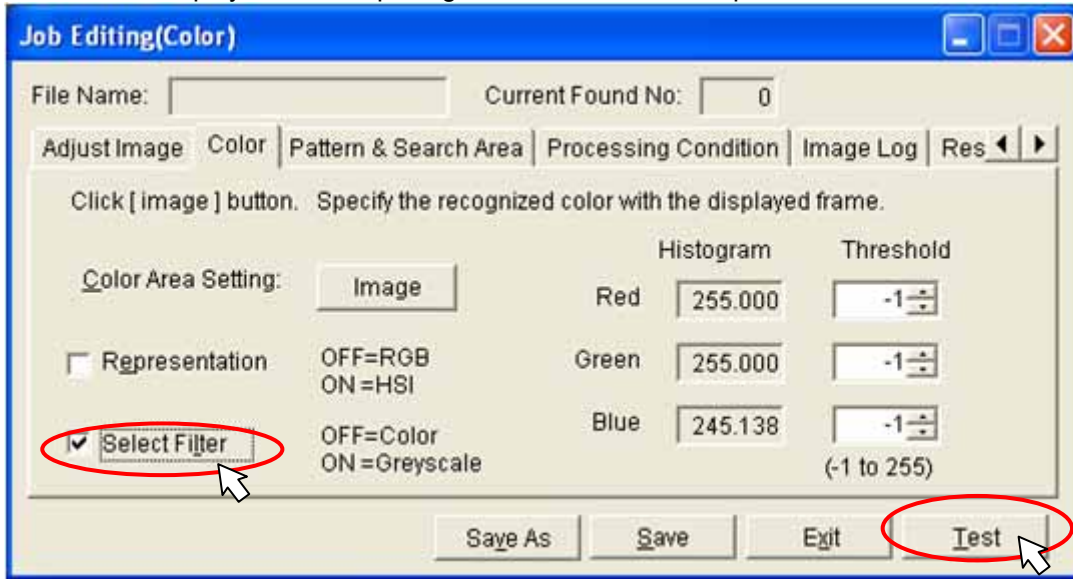

(4-3)Color is adjusted.

Value of "Threshold" is changed, and [Test] button is clicked.

For instance, when green is recognized more emphatically the value of "Green" is increased, and other items are decreased.

Refer to "Histogram" value for the value.

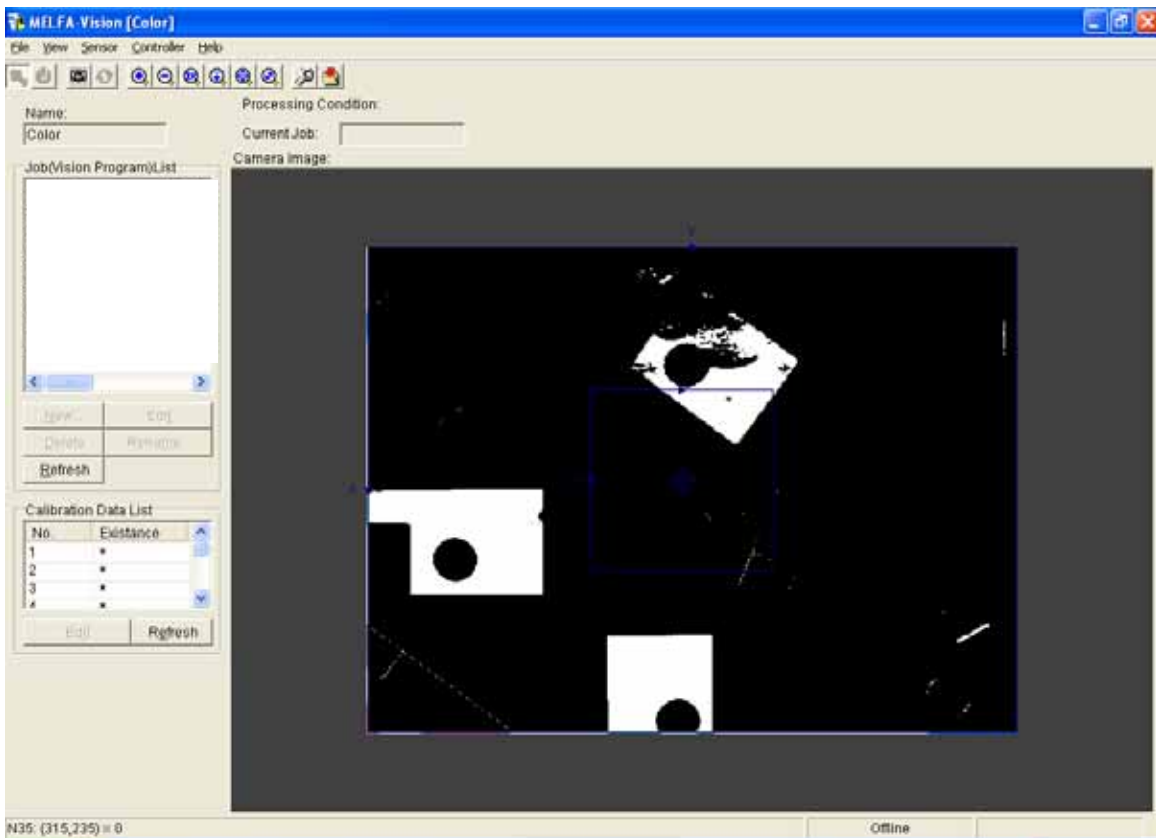
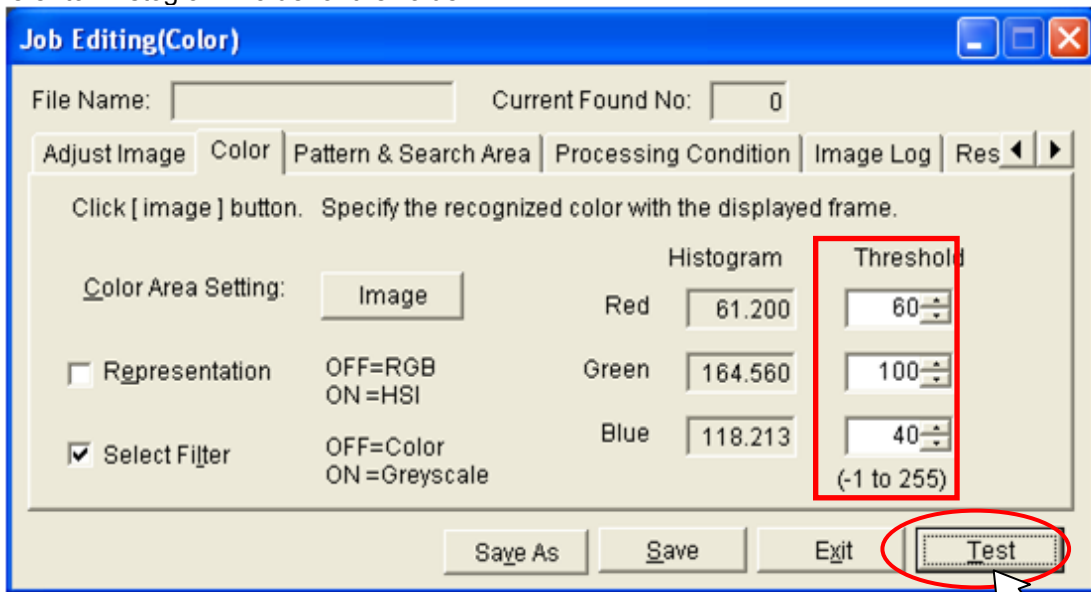

(4-4)When work is recognized specifying not only Hue but also Saturation and Intensity, "Representation" is changed.  
 "Representation" CheckBox is ON, all the values of the item of "Threshold" are set to "-1", and [Test] button is clicked.

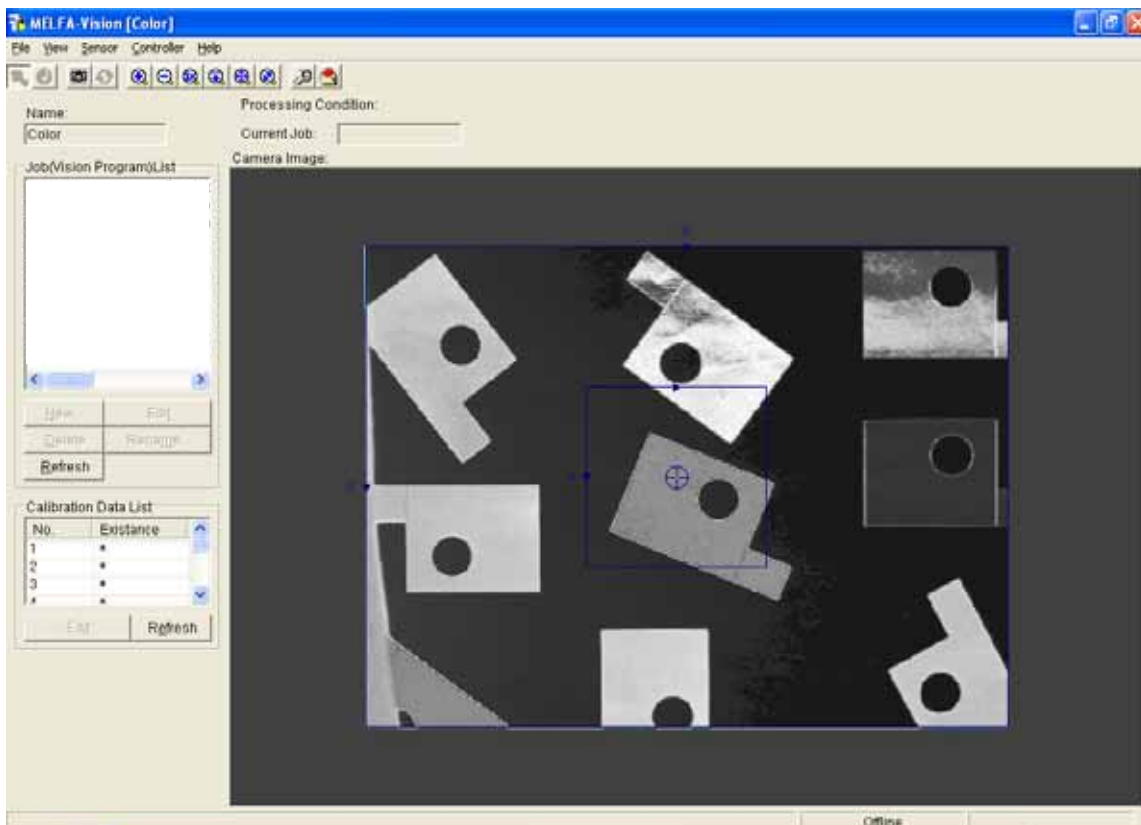
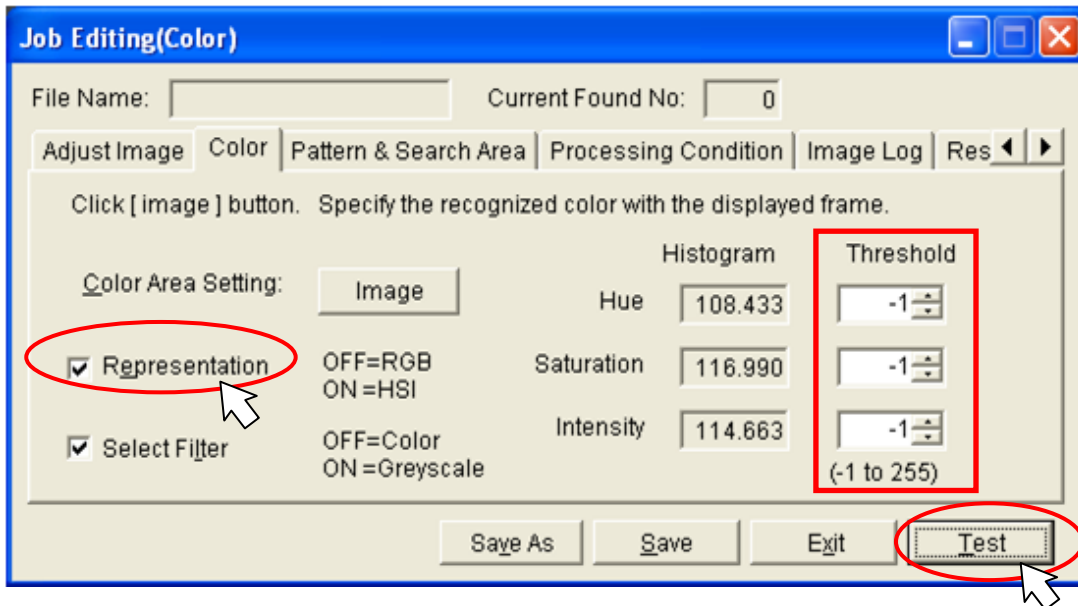

(4-5)Color is adjusted.

Value of "Threshold" is changed, and [Test] button is clicked.

For instance, when recognize the vivid color work the value of "Saturation" is increased, and other items are decreased.

Refer to "Histogram" value for the value.

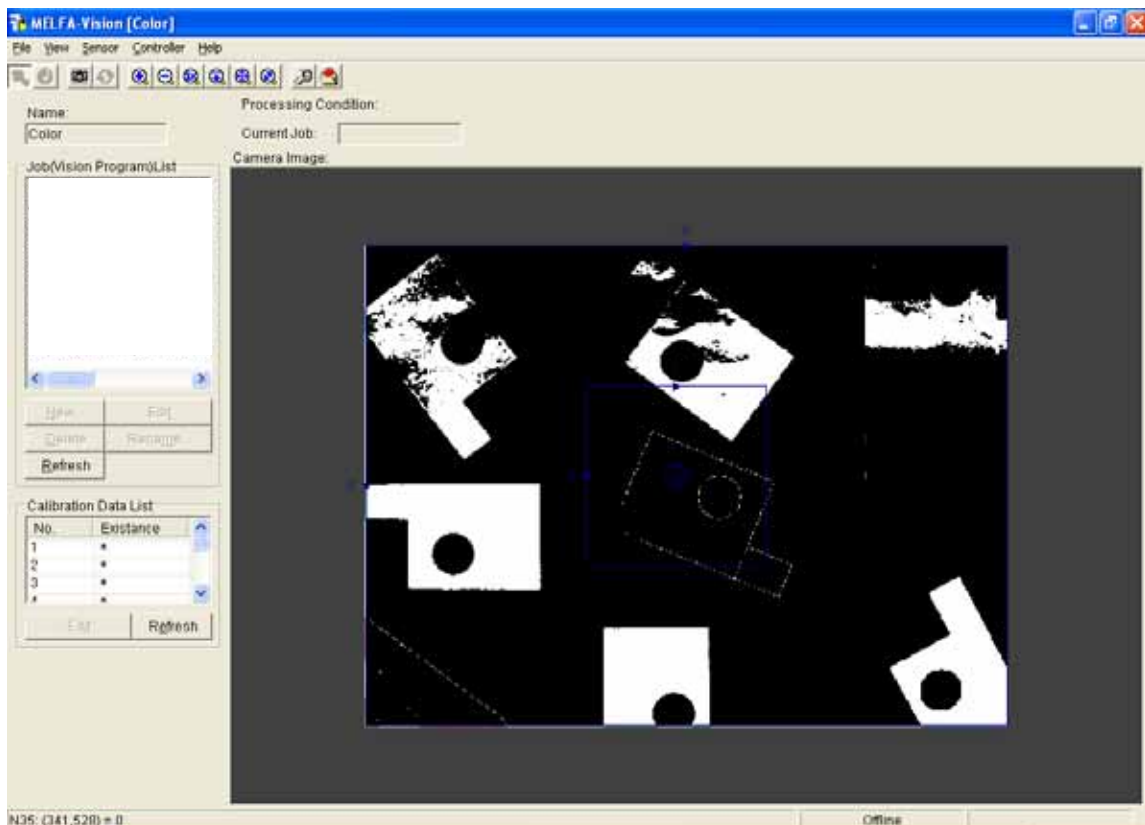
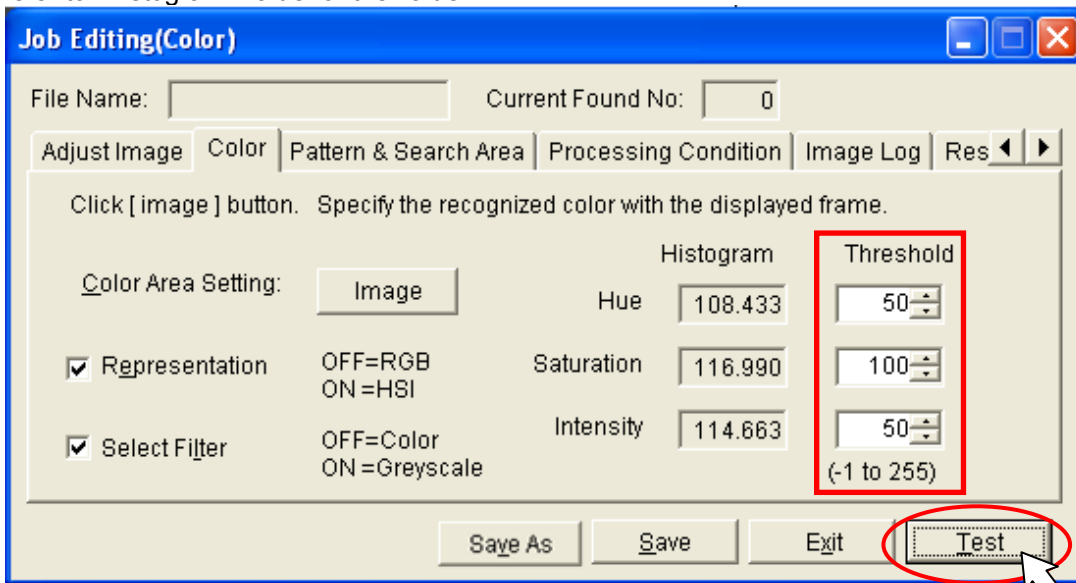

(5) Pattern and Search Area are specified.

[Pattern & Search Area] tab is displayed, and the recognized work is registered.

Refer to "6.3.3 Image processing settings" for registration method.

(6) The condition of recognizing it is specified.

[Pattern & Search Area] tab is displayed, and the recognized work is registered.

[Condition] tab is displayed, and the condition of recognizing it is specified.

Refer to "6.3.3 Image processing settings" for registration method.

#### 9.3.4. Using image processing for which there is no template

The only templates provided for MELFA-Vision are pattern matching and blobs. \* When using a robot using other image processing, write the vision program using "In-Sight Explorer" installed on the PC with "5.3.1 Vision sensor dedicated software (In-Sight Explorer before Ver.4.1) installation".

For details on how to write a vision program using "In-Sight Explorer", see the "In-Sight Explorer" help.



9.3.5. To shorten the time for transferring data with the robot controller

The image processing templates prepared for MELFA-Vision use the mechanism of transferring the information on recognized work to the robot controller one set at a time (three communications, X, Y, and C per piece of work).

When it is desired to shorten the tact time, it is recommended that the vision program and robot program be altered to shorten the data transfer time.

Below is the method for transferring a maximum of four sets of data (127 bytes maximum) in each data transfer.

<Vision program change example>

■ Before change

	I	J	K	L	M	N	O
79	Convert the point into the robot coordinate by the Calibration of No.1 Robot.						
80	X	Y	C	Score			
81	POINT	355.521	59.887	48.485	99.997		
82	POINT	421.531	44.300	-67.008	99.997		
83	POINT	316.099	-80.646	89.732	99.997		
84	#ERR	#ERR	#ERR	#ERR	0.000		

Data exists in each cell in the vision program and the robot controller can use them without processing the acquired values.

However, in the example above, since a total of 12 data transfers are required for cells [J81] through [L84], the transfer time becomes longer.

■ After change

	O	P	Q	R	S	T	U	V	W	X	Y	Z
79	# ERR is converted into E.			The results are connected.								
80	X	Y	C									
81	355.521	59.887	48.485	355.521362,59.886929,48.484764/421.531189,44.30006,-67.007538/316.098572,-80.6457								
82	421.531	44.300	-67.008									
83	316.099	-80.646	89.732									
84	E	E	E									

The value converts errors into a text string as is. Text string cells are linked to form a single cell.

The above program is added to the vision program before change.

Cells [O81] through [Q84] use the vision program "count error" function. If there is an error, they display the character "E". Also, cell [S81] stores the data for the four cells [O81] – [Q84] in one cell. The vision program "concatenate" function is used. Coordinates are delimited with "," and recognized work is delimited with "/". For details on the functions used in vision programs, see the "In-Sight Explorer" help.

 CAUTION

**The maximum number of characters the robot can receive in one communication is 127.**

Due to restrictions on communications with the robot, if the information for one piece of work is X, Y, and C, one data transfer can handle up to four sets of data.



<Robot program change example>

Change the program example in "7.3.2 Writing a Sample Robot Program" as follows. The parts of the program in the boxes are the locations changed.

10 ' The work grasping position P1, and the work placement position P2 must have been taught beforehand.

20 ' Example: P0=(+250.000,+350.000,+500.000,-180.000,+0.000,+0.000)(7,0)

30 ' P1=(+500.000, +0.000, +300.000, -180.000, +0.000, +10.000)(7,0)

40 ' P2=(+300.000,+400.00,+300.000,-180.000,+0.000,+90.000)(7,0)

#### 50 DIM MV(30,3)

60 IF M\_NVOPEN(1)<>1 THEN 'If vision sensor number 1 logon is not complete

70 NVOPEN "COM2:" AS #1 'Connects with the vision sensor connected to COM2.

80 ENDIF

90 WAIT M\_NVOPEN(1)=1 'Connects with vision sensor number 1 and waits for logon to be completed.

#### 100 NVPST #1,"Job2","E76","S81","S81",2,10 'Starts the [Job2] vision program and

110 'receives the recognized count from cell [E76] and the recognized coordinates from cell [S81] and stores them in C\_NVS1().

120 MOV P0

' Moves to the evacuation point.

130 IF M\_NVNUM(1)=0 THEN \*NG

' If the detection count is 0, jump to error

140 MROW=1

' Clears the acquired cell row.

150 MROW=1

' Clears the recognized work number.

160 MKOSU=0

' Specifies the work information (X, Y, C)

170 MST=1

' Clears the head position extracting characters from the

text string.

180 MED=1

' Clears the tail position from which characters were

extracted from the text string the previous time.

190 MFLG1=0

' Clears the flag showing that all the information has been acquired.

200 WHILE MFLG1=0

' Loops until all the information is acquired.

210 CGET\$=C\_NVS1(MROW,1)

' Acquires cell information.

220 MLEN=LEN(CGET\$)

' Obtains the character count for the cell information acquired.

230 IF MLEN<>0 THEN

' When acquired cell information exists

240 FOR MPT=1 TO MLEN

' Loops for amount of cell information acquired

250 C1\$=MID\$(CGET\$,MPT,1)

' Acquires cell information one cell at a time

260 IF C1\$="," OR C1\$="/" THEN

' If the acquired character is "," or "/"

270 C2\$=MID\$(CGET\$,MPT-1,1)

' Acquires the information one character before a "," or "/"

280 MKOSU=MKOSU+1

' Updates the work information

290 IF C2\$<>"E" THEN MV(MNUM,MKOSU)=VAL(MID\$(CGET\$,MST,MPT-MED)) ELSE

MV(MNUM,MKOSU)=0

300 MST=MPT+1

' Specifies the head position extracting text.

310 MED=MST

' Specifies the tail position from which text was extracted.

320 ENDIF

330 IF C1\$="/" THEN

' If the acquired character is "/"

340 MNUM=MNUM+1

' Updates the recognized work number.

350 MKOSU=0

' Clears the work information.

360 ENDIF

370 NEXT MPT

380 MROW=MROW+1

' Moves to the next cell information.

390 ELSE

400 MFLG1=1

' All information acquisition is complete.

410 ENDIF

420 WEND

430 MFLG1=0

' Clears all information acquisition flags.

440 FOR M1=1 TO M\_NVNUM(1)

' Loops once for each detection by vision sensor 1.

450 P10=P1

' Creates the target position P10 using the vision sensor 1 results data.

460 P10.X=MV(M1,1)

470 P10.Y=MV(M1,2)

480 MC=MV(M1,3)

490 P10.C=RAD(MC)

500 MOV P10,10

' Moves to 10 mm above the work grasping position P10.

510 MVS P10

' Moves to the work grasping position P10.

## 9 Detailed Explanation of Functions

---

520	DLY 0.1	' Wait time of 0.1 second
530	HCLOSE 1	'Closes hand 1.
540	DLY 0.2	' Wait time of 0.2 second
550	MVS P10,10	' Moves to 10 mm above the work grasping position P10.
560	MOV P2,10	' Moves to 10 mm above the work placement position P2.
570	MOV P2	' Moves to the work placement position P2.
580	DLY 0.1	' Wait time of 0.1 second
590	HOPEN 1	'Opens hand 1.
600	DLY 0.2	' Wait time of 0.2 second
610	MVS P2,10	' Moves to 10 mm above the work placement position P2.
620	NEXT	' Repeats.
630	HLT	' Program pause (Create the appropriate processing.)
640	END	' Exit
650	'	
660	*NG	' Error processing
670	ERROR 9000	' Error No. 9000 output
680	HLT	' Program pause (Create the appropriate processing.)
690	END	' Exit

## 9. 4. Detailed explanation of systems combining multiple vision sensors and robots

The systems explained in Chapter 5 through Chapter 0 were systems with one vision sensor and one robot controller.

With this system it is also possible to construct systems with one robot controller and up to seven vision sensors and systems with one vision sensor and up to three robot controllers.

This chapter explains the construction of these systems.

### 9. 4. 1. Systems with one robot controller and multiple vision sensors

This section only explains those aspects of the setting method for constructing a system with one robot controller and multiple vision sensors that are different from the contents covered in Chapter 5 through Chapter 0.

(1) Change the robot controller communication settings.

From the MELFA-Vision menu, select [Controller] – [Communication Setting] to display the "Communication Setting" screen.

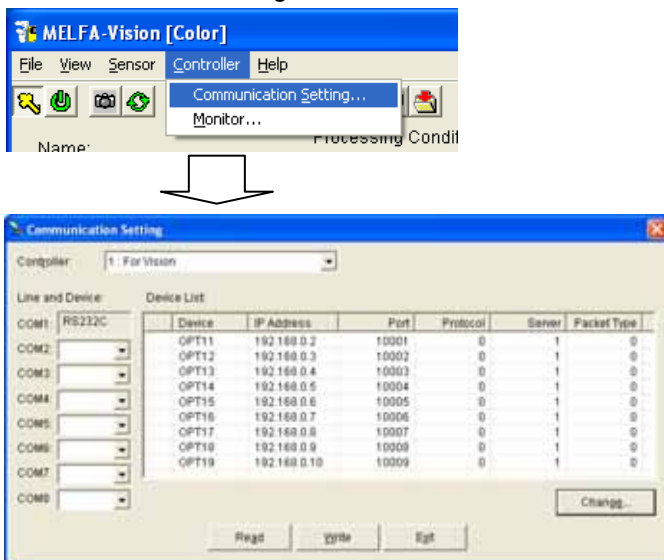

Set the "Line and Device" and "Device List" for the number of vision sensors connected. Below is an example for connecting three vision sensors.

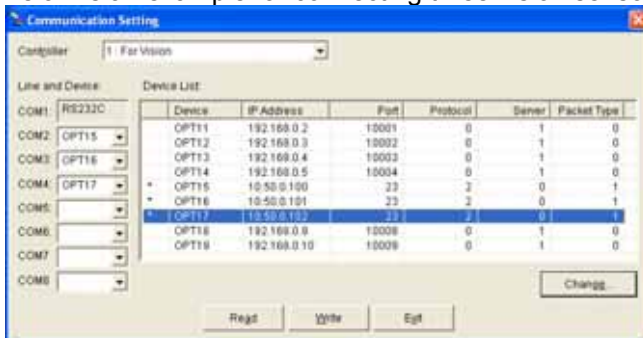

Click the [Write] button to change the robot controller parameters.

(2) Write the vision program for each vision sensor.

Log onto the connected vision sensors and write the vision program for each vision sensor. For details on the logon method and vision program writing method, see "6.3 Work recognition test".

(3) Write the robot program to control multiple vision sensors.

Write a robot program like the following.

```

10 IF M_NVOPEN(1)<>1 THEN NVOPEN "COM2:" AS #1 'Connects to vision sensor 1 (COM2).
20 IF M_NVOPEN(2)<>1 THEN NVOPEN "COM3:" AS #2 'Connects to vision sensor 2 (COM3).
30 IF M_NVOPEN(2)<>1 THEN NVOPEN "COM4:" AS #3 'Connects to vision sensor 3 (COM4).
40 WAIT M_NVOPEN(1)=1 'Connects with vision sensor number 1 and waits for logon to be completed.
50 WAIT M_NVOPEN(2)=1 'Connects with vision sensor number 2 and waits for logon to be completed.
60 WAIT M_NVOPEN(3)=1 'Connects with vision sensor number 3 and waits for logon to be completed.
70 NVPST #1,"Job1","E76","J81","L85",0,10 'Starts the vision program and acquires the results.
80 NVPST #2,"Job1","E76","J81","L85",0,10 'Starts the vision program and acquires the results.
90 NVPST #3,"Job1","E76","J81","L85",0,10 'Starts the vision program and acquires the results.
.....
..... Operates the robot with the results received.
.....
200 NVCLOSE
    
```

### 9.4.2. Systems with one vision sensor and multiple robot controllers

This section only explains those aspects of the setting method for constructing a system with one vision sensor and multiple robot controllers that are different from the contents covered in Chapter 5 through Chapter 0.

This section shows a system with two robots as an example.

(1) Write the vision program for two robots.

See "6.3.3 Image processing settings" and on the "Image Processing Method Selection" screen, select the template for two robots and write the vision program.

When the template for two robots is selected, on the "Job Editing" screen [Processing Condition] tab, the calibration setting items for two robots are displayed.

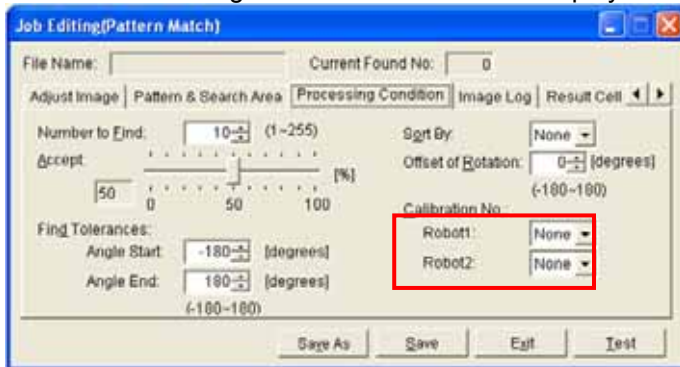

(2) Execute the calibration work for two robots.

See "7.2 Calibration Setting" and execute the calibration work for two robots. When doing the work for the second robot, change the "Robot datum" robot selection.

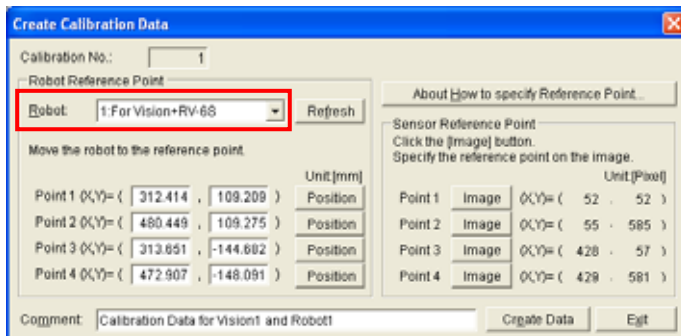

## (3) Set the calibration number.

Specify the calibration number for [Robot 1] and [Robot 2] in [Calibration No.] on the "Job Editing" screen [Processing Condition] tab.

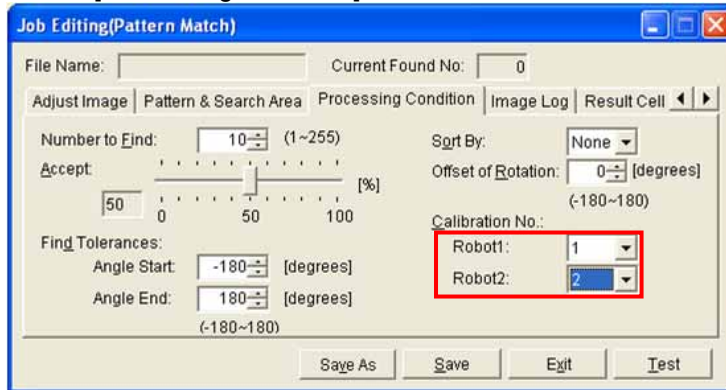

## (4) Write the robot program

<Robot 1>

```

10 IF M_NVOPEN(1)<>1 THEN NVOPEN "COM2:" AS #1      'Connects to vision sensor 1 (COM2).
20 WAIT M_NVOPEN(1)=1                              ' Connects with vision sensor number 1 and waits for logon to be
   completed.
30 NVPST #1,"Job1","E76","J81","L85",0,10          'Starts the vision program and acquires the
   results.
40 M_OUT(10)=1                                     'Notifies Robot 2 that reception is possible.
50 WAIT M_IN(10)=1                                 'Checks that Robot 2 has received the notice.
60 M_OUT(10)=0                                     ' Switches Off the reception possible signal to
   Robot 2.
   .....
   .....Operates the robot with the results received.
   .....
200 NVCLOSE

```

<Robot 2>

```

10 IF M_NVOPEN(1)<>1 THEN NVOPEN "COM2:" AS #1      'Connects to vision sensor 1 (COM2).
20 WAIT M_NVOPEN(1)=1                              ' Connects with vision sensor number 1 and waits for logon to be
   completed.
30 WAIT M_IN(10)=1                                 'Waits for contact from Robot 1.
40 M_OUT(10)=1                                     'Outputs to Robot 1 that it received the notice.
50 WAIT M_IN(10)=0                                 'Checks that Robot 1 has verified reception.
60 M_OUT(10)=0                                     ' Switches Off the notice received signal to Robot
   1.
70 NVIN #1,"Job1","E76","O81","Q85",0,10          'Acquires the results.
   .....
   .....Operates the robot with the results received.
   .....
200 NVCLOSE

```

\* Note that the cell positions for Robot 1 and Robot 2 to acquire data from the vision sensor are different.

## 10. Troubleshooting

This chapter lists the errors that can occur in using network vision sensors and explains the causes of and solutions to these errors.

### 10.1. Error list

Below are the messages for error numbers, their causes, and the solutions.  
The meanings of the error levels in the table are as follows.

**Table 10-1 Error Category List**

Level	Explanation
H High-level error	The servo is switched Off and program execution stopped.
L Low-level error	Program execution is stopped.
C Warning	Program execution is continued.

**Table 10-2 List of Errors for Vision Sensor Use**

Level	Error No.	Error contents	Cause	Solution
L	3110	Argument out of range	One of the argument values specified in a command is out of its range.	Check the argument range and re-input.
L	3120	Incorrect argument count	The number of arguments in the executed command is incorrect.	Check the argument count and re-input.
L	3130	Attempt was made to open an already open communication file.	The communications line that was the subject of the attempted opening is already open.	Check the COM number and vision sensor number and re-execute. Or check the communications parameters.
L	3141	The NVOPEN command is not executed.	No NVOPEN command was executed before execution of a command communicating with the vision sensor.	Revise the robot program to execute the NVOPEN command.
L	3142	The communication line can not be opened.	The line for communication with the vision sensor can not be opened.	Check the communication cable or the communications parameters.
L	3287	This command can not be used if the start condition is ERR or ALW.	This command can not be used if the start condition is ERR or ALW.	Revise the program.
L	3810	Incorrect argument type	The arithmetic calculation, single-item calculation, comparison, or function argument type is incorrect.	Specify the correct argument.
L	4220	Syntax error in input command	There is a mistake in the structure of the input command.	Check the program contents, then re-input with the correct syntax.
L	4370	Array element mistake	1. An array element is outside the defined range. 2. A variable was specified that can not be arrayed.	1. Revise the array elements to be within 1 – maximum element. 2. Stop array element specification.
L	7810	Abnormal Ethernet parameter setting	The parameter setting is incorrect.	Check the NETHSTIP, NETPORT, NETMODE, and other such parameters.

Table 10-3 List of Errors Only for Vision Sensors

Level	Error No.	Error contents	Cause	Solution
L	8600	Vision sensor not connected	There is no vision sensor connected to the specified COM number.	Check the specified vision program number, "COMDEV" parameter, etc. settings.
L	8601	Logon not possible	The communication line was opened, but there is no response from the vision sensor.	Reset the program and start it again.
L	8602	Wrong password	The password for the user set with the "NVUSER" password is not set in the "NVPSWD" parameter.	Set the correct password.
L	8603	Parameter abnormality	The user name or password parameter is abnormal.	Check the NVUSER and NVPSWD parameters.
L	8610	Abnormal communications	Communication with the vision sensor was cut off before or during command execution.	Check the communication cable between the robot and vision sensor.
L	8620	Abnormal vision sensor number specification	The specified vision sensor number is not defined with an NVOOPEN command.	Check that the specified vision sensor number is correct. Also, check that that number is defined with an NVOOPEN command.
L	8621	Abnormal vision program name	The specified vision program name is more than 15 characters.	Specify a vision program name with no more than 15 characters.
L	8622	Vision program not present.	The specified program does not exist in the specified vision sensor.	Check whether the specified vision program exists in the specified vision sensor. Also check that the vision program name specified is correct.
L	8630	Incorrect value in recognition count cell	The recognition count value was not in the cell specified as the recognition count cell.	Check that the correct cell is specified.
L	8631	Specified cell value out of range	Corresponding to either the following. <ul style="list-style-type: none"> <li>•The values specified for the start cell and end cell are reversed.</li> <li>•The range specified by Start Cell and End Cell exceeds line 30 and row 10.</li> <li>•The number of data included in the cell which specifies it by Start Cell and End Cell exceeds 90.</li> </ul>	<ul style="list-style-type: none"> <li>•Check that the correct cell is specified.</li> <li>• Check the number of data acquired from the cell which specifies it by Start Cell and End Cell.</li> </ul>
L	8632	Vision sensor response timeout	There is no response from vision sensor within the specified time or within a specific time.	Check that the specified time is correct. Or check that the vision sensor settings are correct.
L	8633	NVTRG response timeout	No response to image capture request.	Check the communications cable.
L	8634	There is a comma within the specified range of the cell.	There is a comma on the cell which specifies it for Start Cell and End Cell though the range from 1 to 3 is specified for a value of Type.	Check the value set to Type or Start Cell and End Cell.

## 10 Troubleshooting

L	8635	There is no comma within the specified range of the cell.	There is no comma on the cell which specifies it for Start Cell and End Cell though the range from 4 to 7 is specified for a value of Type.	Check the value set to Type or Start Cell and End Cell.
L	8640	Abnormal image capture specification	The image capture specification is other than "camera", "external", and "manual".	Specify an image capture specification of "camera", "external", or "manual".
L	8650	Put online.	The vision sensor is offline.	Put the vision sensor online to enable control from the outside.
L	8660	Not permitted to control vision sensor	The NVUSER and NVPSWD parameters set for logging on to the vision sensor do not have the right to full access to the vision sensor.	Check the vision sensor side user list registration and specify the name of a user with full access in NVUSER and their password in NVPSWD.
L	8670	Restart not possible after stop	After the program was stopped, it was started without being reset.	Reset the robot program, then start it.



## 11. Appendix

### 11.1. Performance of this product (comparison with built-in type RZ511 vision sensor)

Below is a comparison of the performance of this product with that of our built-in type vision sensors.

#### 11.1.1. Comparison of work recognition rate

##### (1) Comparative results by work shape and conditions

Table 11-1 Comparative Results by Work Shape and Conditions

Work condition	Network vision sensor	Built-in vision sensor
Overlap	○	×
Approach or contact	○	×
Tilt	○	△
Front/rear judgment	○	△

○: Recognition with pretty much no problems possible

△: Recognition possible under some conditions      ×: Recognition almost impossible

With network vision sensors, it is possible to recognize overlapping work and work nearly in contact or in contact, work that is difficult to recognize with the built-in vision sensors. Network vision sensors also improve the recognition rate for tilted work and front/rear work.

##### (2) Comparison of functions for recognition pattern registration

Table 11-2 Comparison of Functions for Recognition Pattern Registration

Function	Network vision sensor	Built-in vision sensor
Area size change	Yes	Yes
Specification of coordinates for output to robot	Yes	Yes
Area angle change	Yes (No need to change the work angle)	No (Necessary to change the work angle)
Area shape change	Yes (Square/fan shape/round)	No (Square only)

Network vision sensors improve the work pattern registration functions.

It is possible to change the area angle without any need to change the work angle and the area shape can be changed to square, fan shaped or circle.

#### 11.1.2. Comparison of image processing capacity

Table 11-3 Image Processing Capacity

	Network vision sensor			Built-in vision sensor		
	4	10	30	4	10	30
Image processing time	276ms	278 ms	367 ms	794ms	946ms	946ms
Data transfer time	121 ms	142 ms	249 ms	80ms	99ms	127ms
Total time	397 ms	420 ms	616 ms	874ms	1045ms	1073ms

"Table 11-3 Image Processing Capacity" shows the measurement results when the work is recognized with the same conditions.

The image processing time can be reduced by using network vision sensors.

For network vision sensors, the increase in the number of pieces of work recognized increases the data transfer time.

### 11.1.3. Factors affecting the processing time

Factors affecting the processing time

- (1) Delay in communication time by hub and communication time when no hub used

There is almost no difference in communication time due to a hub.

There is no problem with any hubs, but when an old hub is used, there is a possibility of some variation in communication time.

There is no particular difference in the communication time when connecting directly with a cross-cable without using a hub.

- (2) About the affect of other equipment connected to the network

When equipment other than the network vision sensor, robot controller, or monitor PC is connected to the network, the communication time may become longer.

Even when a program operates that communicates using a network with a monitor PC connected to the network, the communication time may become longer.

## 11.2. Calibration No. marking sheet

This is a marking sheet used in calibration work. Enlarge or reduce it as necessary to match the size of the field of vision of the image.

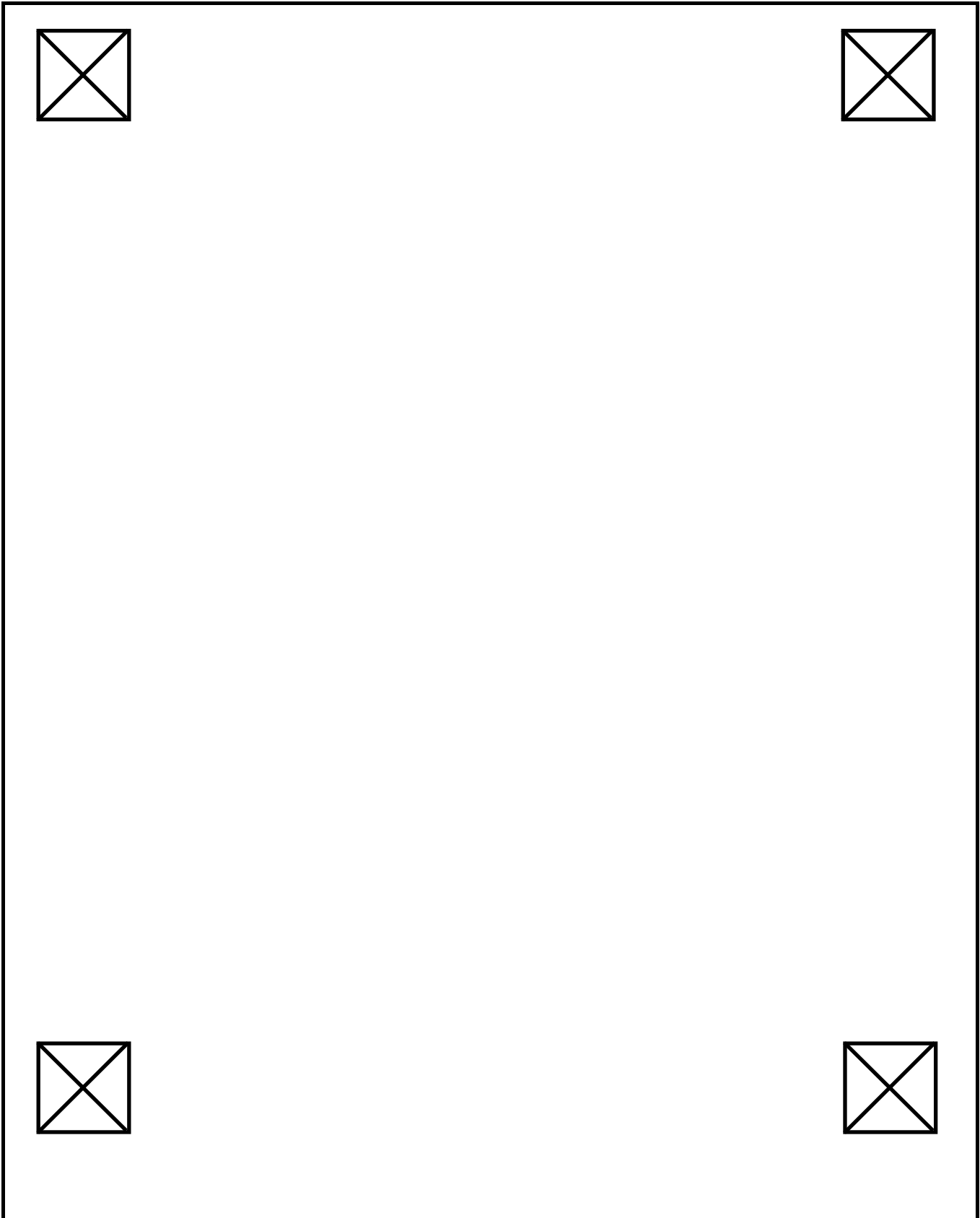



HEAD OFFICE : MITSUBISHI DENKI BLDG MARUNOUCHI TOKYO 100-8310  
NAGOYA WORKS : 1-14, YADA-MINAMI 5, HIGASHI-KU, NAGOYA, JAPAN