

SUPER AE

World-Super Series

Technical Catalogue



**Low Voltage Switchgears /// Air Circuit
Breakers /// Air Circuit Disconnectors ///**

Further Publications within the LVS, PLC and inverter range

Technical Catalogues

WS-Series Technical Catalogue

Product catalogue for circuit breakers and disconnectors
from 3 A to 1600 A rated current

MS-N Technical Catalogue

Product catalogue for low voltage contactors and relays
from 20 A to 1000 A rated current

PLC and Inverter Technical Catalogues

Product catalogues for programmable logic controllers and
frequency inverters (more details on request)

More information?

This technical catalogue is designed to give an overview of the extensive range of the World SUPER AE series. If you cannot find the information you require in this catalogue, there are a number of ways you can get further details on configuration and technical issues, pricing and availability.

For technical issues visit the www.mitsubishi-automation.com website.

Our website provides a simple and fast way of accessing further technical data and up to the minute details on our products and services. Manuals and catalogues are available in several different languages and can be downloaded for free.

For technical, configuration, pricing and availability issues contact our distributors and partners.

Mitsubishi partners and distributors are only too happy to help answer your technical questions or help with configuration building. For a list of Mitsubishi partners please see the back of this catalogue or alternatively take a look at the "contact us" section of our website.

About this technical catalogue

This catalogue is a guide to the range of products available. For detailed configuration rules, system building, installation and configuration the associated product manuals must be read. You must satisfy yourself that any system you design with the products in this catalogue is fit for purpose, meets your requires and conforms to the product configuration rules as defined in the product manuals.

Specifications are subject to change without notice. All trademarks acknowledged.

© Mitsubishi Electric Europe B.V., Factory Automation - European Business Group (Version F)

WORLD SUPER AE SERIES

BASE UNITS

◆ Product Skeleton of Accessories	4	1
◆ Specifications	6	
◆ Connections	8	
◆ Order information	9	2
◆		

ACCESSORIES

◆ Overview of the main accessories	10	3
◆ Description of the optional accessories	11	
◆ Undervoltage trip device	12	
◆ Shunt trip device, Auxiliary switch	13	
◆ Terminal adapters	15	
◆ Interlock devices	16	
◆ Covers and door frames	17	
◆ Current transformer	18	
◆ Power supply unit's		

ELECTRONIC TRIP RELAY

◆ Introduction and selection	20	
◆ Standard and special Functions	21	
◆ Characteristics	22	
◆ General Protection S types	24	
◆ General Protection M types	25	
◆ Optional setting Modules	26	
◆ Extension and display modules	28	
◆ Interface units	29	

APPENDIX

◆ Index	31	
---------------	----	--

BASE UNITS ///

Product Skeleton of Accessories for SUPER AE Series Air Circuit Breakers

1

BASIC COMPONENTS

Mitsubishi Electric offers a wide range of accessories for the Air Circuit Breakers to serve almost all variations of applications.

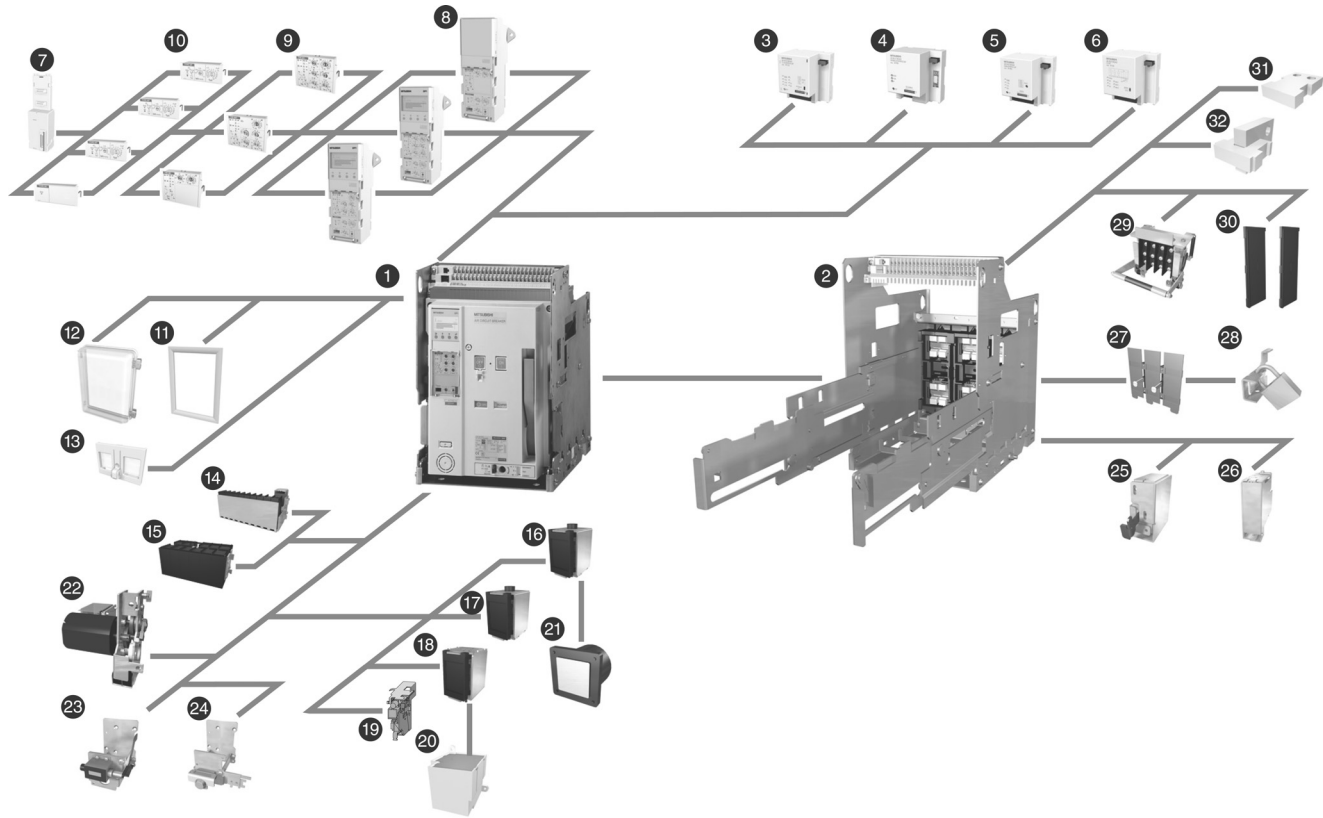

Position	Name
1	Air circuit breaker
2	Cradle
3	CC-Link® Interface unit
4	PROFIBUS-DP Interface unit
5	MODBUS® Interface unit
6	I/O unit
7	Extension module
8	ETR unit
9	Main setting module
10	Optional setting module
11	Door frame (DF)

Position	Name
12	Dust cover (DUC)
13	Push button cover (BC-L)
14	Auxiliary switch standard (AX)
15	Auxiliary switch high capacity type (HAX)
16	Shunt trip device (SHT)
17	Closing coil (CC)
18	Under voltage trip device (UVT)
19	Trip coil
20	UVT-controller (U-CON)
21	Condenser trip device (COT)
22	Motor charging device (MD)

Position	Name
23	Counter (CNT)
24	Cylinder lock (CYL)
25	Door interlock (DI)
26	Mechanical interlock (MI)
27	Safety shutters (SST)
28	Safety shutter lock (SST-LOCK)
29	Cell switch (CL)
30	Interphase Barrier (BA)
31	Horizontal terminal
32	Vertical terminal

Product Introduction of Accessories for SUPER AE Series Air Circuit Breakers

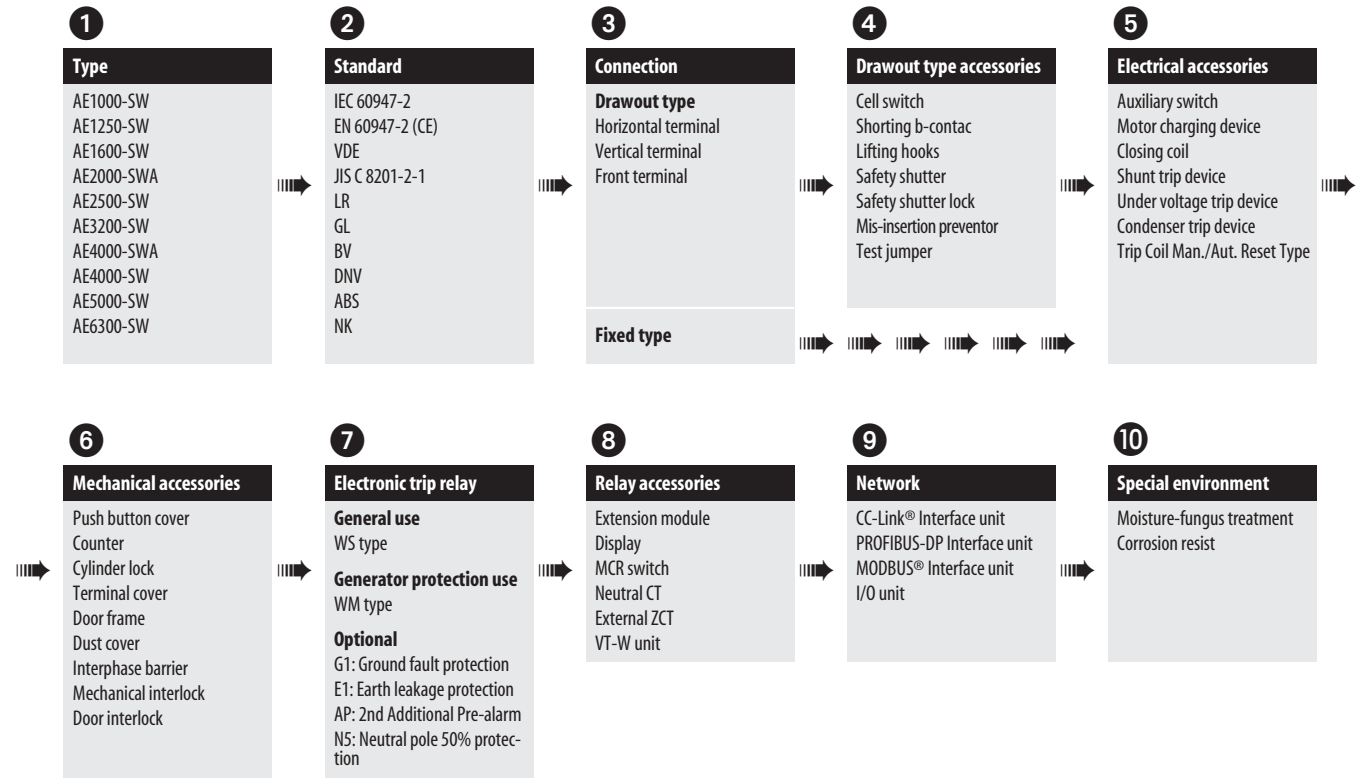

For details on our full range including accessories contact your local distributor

BASE UNITS ///

Specifications

1

BASIC COMPONENTS

SUPER AE		Breaker type	AE 1000- SW		AE 1250- SW		AE 1600 SW		AE 2000- SWA		
Frame size		A	1000		1250		1600		2000		
Rated insulation voltage (AC V) 50/60 Hz		Ui			1000						
Rated operating voltage (AC V) 50/60 Hz		Ue			690						
Rated impulse withstand voltage (kV)		Uimp			12						
Pollution degree					3						
Number of poles		P	3	4	3	4	3	4	3	4	
Rated current in (CT rating)			1000		1250		1600		2000		
Adjustment range Rated current (A) I _r	General use (current rating adjustable 0.5 to 1.0 x I _n 0.05 step)		500-550-600-650- 700-750-800-850- 900-950-1000		625-687.5-750-812.5- 875-937.5-1000-1062.5-1125- 1187.5-1250		800-880-960-1040- 1120-1200-1280-1360- 1440-1520-1600		1000-1100-1200-1300- 1400-1500-1600-1700- 1800-1900-2000		
	Generator protection (current rating fixed)		400 ≤ I _r ≤ 1000		800 ≤ I _r ≤ 1250		1000 ≤ I _r ≤ 1600		1250 ≤ I _r ≤ 2000		
Rated current of neutral pole		(A)	1000		1250		1600		2000		
IEC 60947-2, EN 60947-2, BV, VDE, JIS C 8201-2-1	Ultimate breaking capacity I _{cu} (kA rms)	690V AC	65		65		65		65		
		600V AC	65		65		65		65		
		240 – 500V AC	65		65		65		65		
		With MCR	690V AC	65		65		65		65	
		600V AC	65		65		65		65		
		240 – 500V AC	65		65		65		65		
Without instantaneous	690V AC	25 ^①		25 ^①		25 ^①		25 ^①			
	500V AC	25 ^①		25 ^①		25 ^①		25 ^①			
Rated service breaking capacity I _{cs} (kA rms) % I _{cu}											
Rated making capacity I _{cm} (kA, peak)	690V AC	143		143		143		143			
	600V AC	143		143		143		143			
	240 – 500V AC	143		143		143		143			
	With MCR	690V AC	143		143		143		143		
	600V AC	143		143		143		143			
	240 – 500V AC	143		143		143		143			
Without instantaneous	690V AC	52.5		52.5		52.5		52.5			
	500V AC	52.5		52.5		52.5		52.5			
Rated short time withstand current (kA rms) I _{cw}											
	1s	65		65		65		65			
	2s	60		60		60		60			
	3s	50		50		50		50			
Maximum total breaking time		(ms)	40 ^②		40 ^②		40 ^②		40 ^②		
Closing time		(ms)	80		80		80		80		
Number of operating cycles ^② (ON/OFF)	With rated current	500V AC I _n	5000		5000		5000		1500		
		690V AC I _n	5000		5000		5000		1500		
	Without rated current	25000		25000		25000		25000 ^④			
Connecting terminal											
	Horizontal terminal	○		○		○		—			
	Vertical terminal	○		○		○		○ ^⑤			
	Front terminal	○		○		○		—			
Dimensions (H x W x D mm)											
	Fixed type	3-pole			410 x 340 x 290						
		4-pole			410 x 425 x 290						
	Drawout type	3-pole			430 x 300 x 368						
		4-pole			430 x 385 x 368						
Weight (kg)	Fixed type	3-pole	41		41		42		47		
		4-pole	51		51		52		57		
	Drawout type (with cradle)	3-pole	64		64		65		70		
		4-pole	78		78		79		84		
	Cradle only	3-pole	26		26		26		31		
		4-pole	30		30		30		35		

- ① The columns for "without instantaneous" are the values when the bare main body and the external relay is combined.
 ② The number of operating cycles without rated current also include the number of operating cycles with rated current.
 ③ AE2000-SWA and AE4000-SWA apply for only vertical terminal of connecting terminal.
 ④ This value means number of operating cycles of ACB's body not including accessories.
 ⑤ Products with low rating types is available.

AE 2000- SW		AE 2500- SW		AE 3200- SW		AE 4000- SWA		AE 4000- SW		AE 5000- SW		AE 6300- SW	
2000		2500		3200		4000		4000		5000		6300	
		1000								1000			
		690								690			
		12								12			
		3								3			
3	4	3	4	3	4	3	4	3	4(HN, FN) ⑦	3	4(HN, FN) ⑦	3	4(HN, FN) ⑦
2000		2500		3200		4000		4000		5000		6300	
1000-1100-1200-1300-1400-1500-1600-1700-1800-1900-2000 ⑤		1250-1375-1500-1625-1750-1875-2000-2125-2250-2375-2500		1600-1760-1920-2080-2240-2400-2560-2720-2880-3040-3200		2000-2200-2400-2600-2800-3000-3200-3400-3600-3800-4000		2000-2200-2400-2600-2800-3000-3200-3400-3600-3800-4000		2500-2750-3000-3250-3500-3750-4000-4250-4500-4750-5000		3150-3465-3780-4095-4410-4725-5040-5355-5670-5985-6300	
800 ≤ Ir ≤ 2000		1600 ≤ Ir ≤ 2500		2000 ≤ Ir ≤ 3200		2500 ≤ Ir ≤ 4000		2500 ≤ Ir ≤ 4000		3150 ≤ Ir ≤ 5000		4000 ≤ Ir ≤ 6300	
2000		2500		3200		4000		2000 (4000) ⑧		2500 (5000) ⑧		3150 (6300) ⑧	
75		75		75		75		85		85		85	
75		75		75		75		85		85		85	
85		85		85		85		130		130		130	
75		75		75		75		85		85		85	
75		75		75		75		85		85		85	
75		75		75		75		100		100		100	
45 ①		45 ①		45 ①		45 ①		65 ①		65 ①		65 ①	
45 ①		45 ①		45 ①		45 ①		65 ①		65 ①		65 ①	
		100%								100%			
165		165		165		165		187		187		187	
165		165		165		165		187		187		187	
187		187		187		187		286		286		286	
165		165		165		165		187		187		187	
165		165		165		165		187		187		187	
165		165		165		165		220		220		220	
94.5		94.5		94.5		94.5		143		143		143	
94.5		94.5		94.5		94.5		143		143		143	
75		75		75		75		100		100		100	
75		75		75		75		85		85		85	
65		65		65		65		85		85		85	
40 ⑥		40 ⑥		40 ⑥		40 ⑥		50 ⑥		50 ⑥		50 ⑥	
80		80		80		80		80		80		80	
1500		1500		1000		500		1000		1000		1000	
1500		1500		1000		500		1000		1000		1000	
20000 ④		20000 ④		20000 ④		20000 ④		10000 (3P) / 5000 (4P)		10000 (3P) / 5000 (4P)		10000 (3P) / 5000 (4P)	
○		○		○		—		—		—		—	
○		○		○		○ ③		○ ③		○ ③		○ ③	
○		○		○		—		—		—		—	
		410 x 475 x 290								414 x 873 x 290			
		410 x 605 x 290								414 x 1003 (1133) x 290 ⑥			
		430 x 435 x 368				430 x 439 x 368				480 x 875 x 368			
		430 x 565 x 368				430 x 569 x 368				480 x 1005 (1135) x 368 ⑥			
60		61		63		81		160		160		160	
72		73		75		99		180 (200) ⑧		180 (200) ⑧		180 (200) ⑧	
92		93		95		108		233		233		240	
113		114		116		136		256 (279) ⑧		256 (279) ⑧		263 (286) ⑧	
35		35		35		49		118		118		125	
43		43		43		61		133 (148) ⑧		133 (148) ⑧		140 (155) ⑧	

- ⑥ This value means the instantaneous breaking time at shortcircuit interruption. As for accessories (SHT, UVT) refer to page 12 and 13.
- ⑦ 4 (HN) means the neutral poles current capacity is 50% of the rated current, for 4-poles.
4 (FN) means the neutral poles current capacity is 100% of the rated current, for 4-poles
- ⑧ () shows the value for 4P FN type.

Remark
All Models conform the isolating function according to IEC 60947-2.
Reverse connection is possible

BASE UNITS ///







BASIC COMPONENTS

1

Connections

Connection arrangements

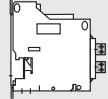
The following connecting methods are available for the AE 1000 – 1600-SW, AE 2000 – 3200-SW.

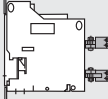
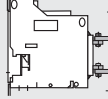
Connection	Horizontal connection	Vertical connection	Front connection	Vertical terminal adapter	Front terminal adapter
Mounting method	Standard	Optional	Optional	Accessory	Optional
Fixed type	 (Standard)	—	—	 (FIX-VTA)	 (FIX-FTA)
Drawout type	 (Standard)	 (DR-VT)	 (DR-FT)	 (DR-VTA)	 (DR-FTA)
Remark	Standard equipment (shipping version)	Special equipment (on request)	Special equipment (on request)	Available as accessory (refer to page 15)	Optional accessory (on request)



Connection image: AE 1000 – 1600-SW, 3-pole type

Standard Fixed type breakers AE1000 - 1250 - 1600-SW, AE2000 - 2500 - 3200-SW are also available as Draw-Out type:

Please order the corresponding cradle with the drawout mechanism (table on next page)

Connection arrangements

The following connecting methods are available for the AE 2000-SWA, AE 4000-SWA.

Connection	Vertical connection
Mounting method	Standard
Fixed type	 (FIX-VT)
Drawout type	 (DR-VT)
Remark	Special equipment (on request)

● Connection image: AE 2000-SWA, 3-pole type

● For AE 2000-SWA, AE 4000-SWA, AE 4000-SW, AE 5000-SW and AE 6300-SW models, vertical terminal only is available.

Available Connections

Breakers		AE1000-SW	AE1250-SW	AE1600-SW	AE2000-SWA	AE2000-SW	AE2500-SW	AE3200-SW	AE4000-SWA	AE4000-SW	AE5000-SW	AE6300-SW
Connections												
Fixed type (FIX)	Horizontal	●	●	●	—	●	●	●	—	—	—	—
	FIX-VT	—	—	—	●	—	—	—	●	●	●	●
	FIX-VTA	○	○	○	—	○	○	○	—	—	—	—
	FIX-FTA	○	○	○	—	○	○	○	—	—	—	—
Drawout type (DR)	Horizontal	●	●	●	—	●	●	●	—	—	—	—
	DR-VT	○	○	○	●	○	○	○	●	●	●	●
	DR-FT	○	○	○	—	○	○	○	—	—	—	—
	DR-VTA	○	○	○	—	○	○	○	—	—	—	—
	DR-FTA	○	○	○	—	○	○	○	—	—	—	—

● Standard ○ Optional

Standard series AE-SW – Fixed type

Base unit equipment	Breaker	3-pole type	Art. no.	4-pole type	Art. no.
Shipping contents: ● Electronic trip Relay base unit ● Power supply PW3 ● 10 auxiliary contacts (5 NO, 5 NC contacts) Further elements that must be ordered: ○ Main setting module for protection ○ Accessories as required	AE 1000 - SW	AE1000-SW 3P Fix, ETRBASE-P3, AX10	168373	AE1000-SW 4P Fix, ETRBASE-P3, AX10	168434
	AE 1250 - SW	AE1250-SW 3P Fix, ETRBASE-P3, AX10	168435	AE1250-SW 4P Fix, ETRBASE-P3, AX10	168436
	AE 1600 - SW	AE1600-SW 3P Fix, ETRBASE-P3, AX10	168437	AE1600-SW 4P Fix, ETRBASE-P3, AX10	168438
	AE 2000 - SW	AE2000-SW 3P Fix, ETRBASE-P3, AX10	168443	AE2000-SW 4P Fix, ETRBASE-P3, AX10	168444
	AE 2500 - SW	AE2500-SW 3P Fix, ETRBASE-P3, AX10	168445	AE2500-SW 4P Fix, ETRBASE-P3, AX10	168446
	AE 3200 - SW	AE3200-SW 3P Fix, ETRBASE-P3, AX10	168447	AE3200-SW 4P Fix, ETRBASE-P3, AX10	168448

Cradle with the drawout mechanism

	Cradle	For type	Art. no.
	CRD163-W	Draw Out type AE1000-AE1600 3P	170078
	CRD164-W	Draw Out type AE1000-AE1600 4P	170079
	CRD323-W	Draw Out type AE2000-AE3200 3P	170080
	CRD324-W	Draw Out type AE2000-AE3200 3P	170081
	REC-FD-W	Drawout mechanism with drawout handle	169004

Air circuit breaker series AE-SWA

Base unit equipment	Breaker	Fixed type	Art. no.	Draw-out type	Art. no.
Shipping contents: ● Electronic trip Relay base unit ● Auxiliary contacts (NO, NC contacts) ● Power supply PW3 Further elements that must be ordered: ○ Main setting module for protection ○ Accessories as required	AE 2000 - SWA	AE2000-SWA 4P Fix, ETRBASE-P3, AX10	168440	AE2000-SWA 3P D/O, ETRBASE-P3, AX10	168441
	AE 2000 - SWA	AE2000-SWA 3P Fix, ETRBASE-P3, AX10	168439	AE2000-SWA 4P D/O, ETRBASE-P3, AX10	168442
	AE 4000 - SWA	AE4000-SWA 3P Fix, ETRBASE-P3, AX10	168449	AE4000-SWA 3P D/O, ETRBASE-P3, AX10	168451
	AE 4000 - SWA	AE4000-SWA 4P Fix, ETRBASE-P3, AX10	168450	AE4000-SWA 4P D/O, ETRBASE-P3, AX10	168452

Air circuit breaker series AE-SW 4000–6300 A – Fixed / Draw-out type

Base unit equipment	Breaker	Fixed type 3/4-pole	Art. no.	Draw-out type 3/4-pole	Art. no.
Shipping contents: ● Electronic trip Relay base unit ● Power supply PW3 ● 10 auxiliary contacts (5 NO, 5 NC contacts) ● Safety shutters Further elements that must be ordered: ○ Main setting module for protection ○ Accessories as required	AE 4000 - SW	AE4000-SW 3P Fix, ETRBASE-P3, AX10	205144	AE4000-SW 3P D/O, ETRBASE-P3, AX10	205153
	AE 5000 - SW	AE5000-SW 3P Fix, ETRBASE-P3, AX10	205145	AE5000-SW 3P D/O, ETRBASE-P3, AX10	205154
	AE 6300 - SW	AE6300-SW 3P Fix, ETRBASE-P3, AX10	205146	AE6300-SW 3P D/O, ETRBASE-P3, AX10	205155
	AE 4000 - SW HN	AE4000-SW HN 4P Fix, ETRBASE-P3, AX10	205147	AE4000-SW HN 4P D/O, ETRBASE-P3, AX10	205156
	AE 4000 - SW FN	AE4000-SW FN 4P Fix, ETRBASE-P3, AX10	205148	AE4000-SW FN 4P D/O, ETRBASE-P3, AX10	205157
	AE 5000 - SW HN	AE4000-SW HN 4P Fix, ETRBASE-P3, AX10	205149	AE4000-SW HN 4P D/O, ETRBASE-P3, AX10	205158
	AE 5000 - SW FN	AE4000-SW FN 4P Fix, ETRBASE-P3, AX10	205150	AE4000-SW FN 4P D/O, ETRBASE-P3, AX10	205159
	AE 6300 - SW HN	AE4000-SW HN 4P Fix, ETRBASE-P3, AX10	205151	AE4000-SW HN 4P D/O, ETRBASE-P3, AX10	205160
	AE 6300 - SW FN	AE4000-SW FN 4P Fix, ETRBASE-P3, AX10	205152	AE4000-SW FN 4P D/O, ETRBASE-P3, AX10	205161

Switch-disconnector AE-SW – Fixed / Draw-out type

Base unit equipment	Breaker	3-pole type	Art. no.	4-pole type	Art. no.
Shipping contents: ● Electronic trip Relay base unit ● 10 auxiliary contacts (5 NO, 5 NC contacts) ● Switching capacity I _n x 6 Further elements that must be ordered: ○ Accessories as required	AE 1000 - SW	AE1000-SW 3P Fix, Bare, AX10	193919	AE1000-SW 4P Fix, Bare, AX10	193920
	AE 1250 - SW	AE1250-SW 3P Fix, Bare, AX10	193921	AE1250-SW 4P Fix, Bare, AX10	193922
	AE 1600 - SW	AE1600-SW 3P Fix, Bare, AX10	193923	AE1600-SW 4P Fix, Bare, AX10	193924
	AE 2000 - SW	AE2000-SW 3P Fix, Bare, AX10	193929	AE2000-SW 4P Fix, Bare, AX10	193930
	AE 2500 - SW	AE2500-SW 3P Fix, Bare, AX10	193931	AE2500-SW 4P Fix, Bare, AX10	193932
	AE 3200 - SW	AE3200-SW 3P Fix, Bare, AX10	193933	AE3200-SW 4P Fix, Bare, AX10	193934
	AE 2000 - SWA	AE2000-SWA 3P Fix, Bare, AX10	193925	AE2000-SWA 4P Fix, Bare, AX10	193926
	AE 4000 - SWA	AE4000-SWA 3P Fix, Bare, AX10	193935	AE4000-SWA 4P Fix, Bare, AX10	193936
	AE 2000 - SWA	AE2000-SWA 3P D/O, Bare, AX10	193927	AE2000-SWA 4P D/O, Bare, AX10	193928
	AE 4000 - SWA	AE4000-SWA 3P D/O, Bare, AX10	193937	AE4000-SWA 4P D/O, Bare, AX10	193938

High performance series AE-SH – Draw-out type – Fixed type (on request)

ACCESSORIES ///

2 ACCESSORIES

Overview and mounting positions of the main accessories

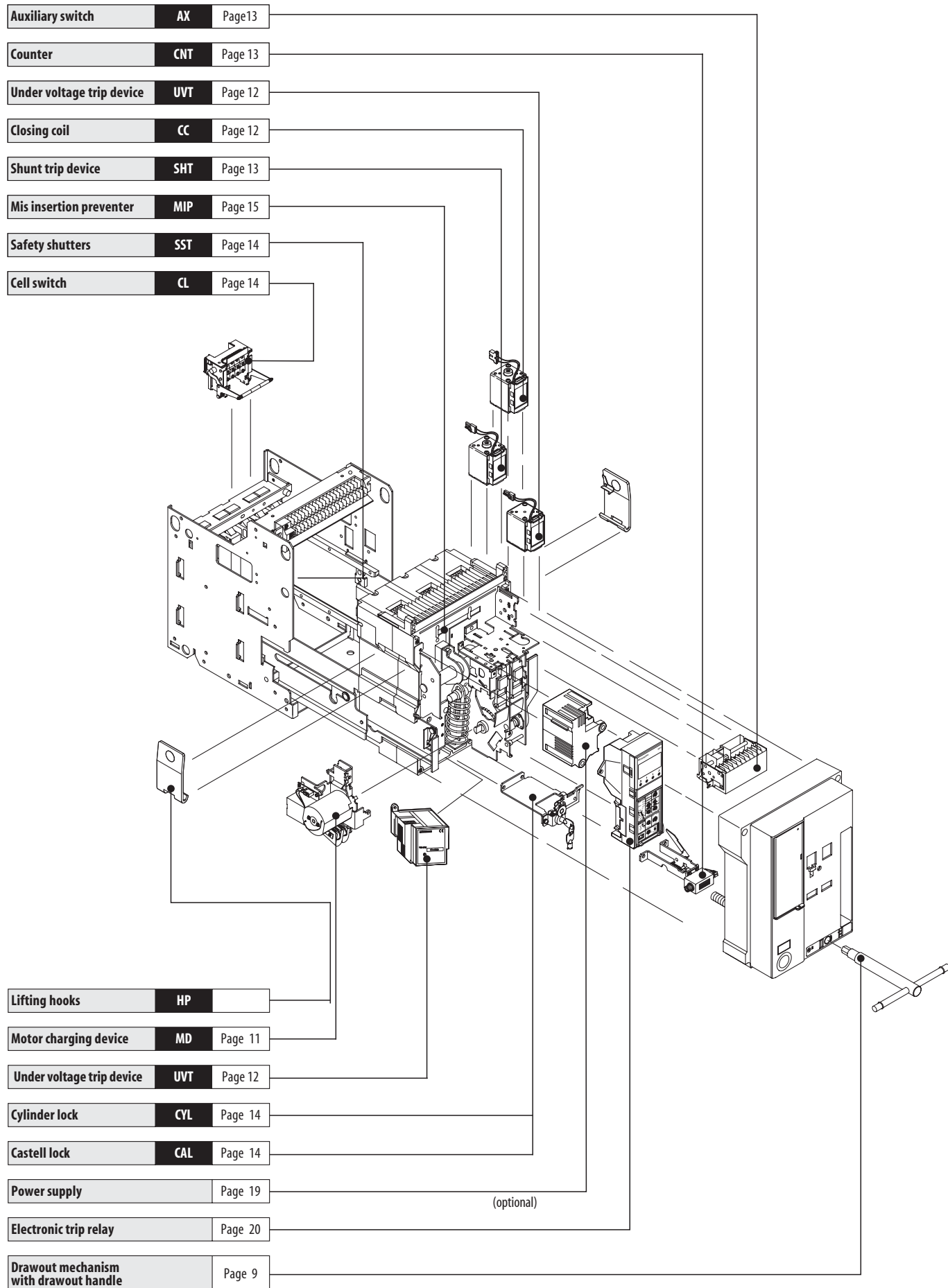

Overview and description on the optional accessories

Motor charging device (MD)

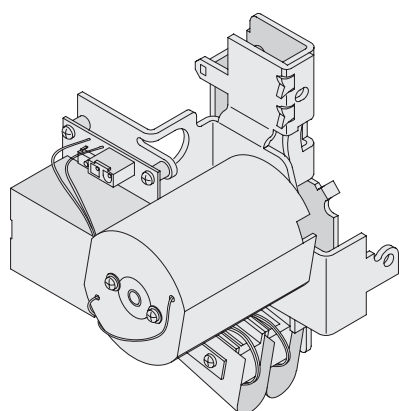

In addition to manual operation, the closing spring can be charged automatically by an electric motor every time the breaker is closed (ON charging method).

If the closing spring is to be charged automatically whenever the breaker is opened, then this can be done through an additional auxiliary contact (AXb) (OFF charging method). As soon as charging is completed, a visual display on the front says "CHARGED".

The "CHARGED" signal is also available via the 413 (TS+) and 414 (TS-) terminals (included in the standard MD configuration).

There is always the option of manual operation in an emergency. A closing coil (CC) is required for closing the breaker by remote control, and a shunt trip device (SHT) is required for opening it in this way.

This warrants the prevention of pumping, both electronically and mechanically. The circuit of the motor is separate from the ON/OFF circuit (CC, SHT).

Specifications	MD-AD125-W	MD-AD250-W	MD-AD125-4A4W-W	MD-AD250-4A4W-W	MD-D024-W	MD-D048-W
Rated voltage	100 – 125 V AC/DC	200– 250 V AC/DC	100 – 125 V AC/DC	200– 250 V AC/DC	24VDC	48 V DC
Applicable voltage range (V)	85 – 137.5	170 – 275	85 – 137.5	170 – 275	18 – 26.4	36– 52.8
Applied voltage (V)	100 / 125	200 / 250	100 / 125	200 / 250	24 V	48 V
Inrush current (peak value) (A)	10 / 12	5 / 6	10 / 12	7 / 8	22	14
Steady current (A)	3	1	4	2	6	3
Charging time (sec)	≤5	≤5	≤5	≤5	≤5	≤5
Criterion for power requirement (VA)	700 / 1000	700 / 1000	700 / 1000	700 / 1000	500	500
Order information	Art. no. 168514	168515	168516	168517	168518	168519

Trip Coil (AL)

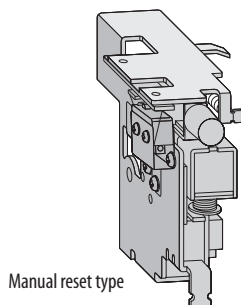

Automatic reset type (TCA-AL-W)

OCR alarm (AL) is provided as standard if ETR is equipped. OCR alarm (AL) is the contact (1a) of short-time operation (30 ms), being output when the breaker is tripped by the electronic trip relay.

Two types of automatic reset type (standard) and manual reset type (optional) are available. When ordering, specify either.

Manual reset type (TCM-AL-W)

On the manual reset type (optional), the gray manual reset button will stick out to continuously output OCR alarm (AL) if the breaker is tripped by the electronic trip relay. After tripping, the breaker can not be turned on unless the manual reset button on the front side of the breaker is pressed for resetting.

Specifications	TCA-AL-W	TCM-AL-W
Voltage	AC (V)	125 / 240
	DC (V)	30, 125 / 240
Resistive load	AC (A)	3 / 5
	DC (A)	0.2 / 0.4 / 4
Inductive load	AC (A)	2 / 3
	DC (A)	0.2 / 0.4 / 4
Order information	Art. no. 168535	168536

Notes:

Though the control power supply is unnecessary to activate OCR alarm (AL), the self-holding circuit is necessary since the contact output is activated for the short time (30 ms). This works when tripping occurs in LTD, STD, INST, GFR or ER.

If any continuous output of OCR alarm (AL) is necessary, use the trip indicator (TI) output contact of the electronic trip relay.

ACCESSORIES ///

2
ACCESSORIES

Undervoltage trip device (UVT)

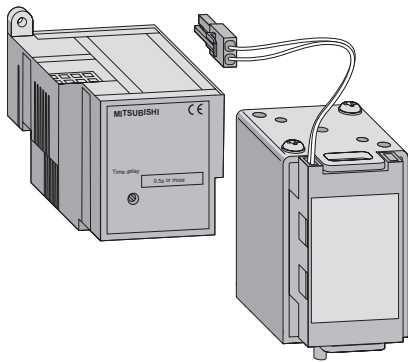

This is the device that automatically trips the breaker when the circuit voltage drops below the nominal voltage, and comprises a UVT coil and UVT controller.

Timerange for tripping time:
INST (0.2 sec or less)/0.25 sec/0.5 sec/
0.8 sec/1.0 sec/1.5 sec/3 sec.

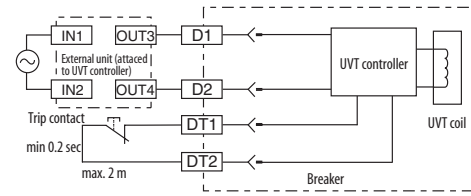
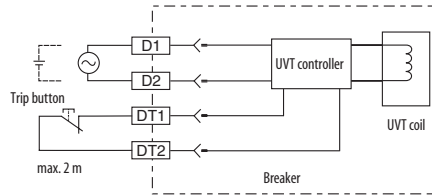

Specifications	UCON- D024B-W INST	UCON- D048B-W INST	UCON- D110B-W INST	UCON- D125B-W INST	UCON- D250B-W INST	UCON- A120B-W INST	UCON- A240B-W INST	UCON- A460B-W INST	
Rated voltage (V)	24 (DC)	48 (DC)	100–110 (DC)	120–125 (DC)	220–250 (DC)	100–120 (AC)	200–240 (AC)	380–460 (AC)	
Frequency	—					50/60 Hz			
Operating time (time delay)	□ Inst (0.2 sec); □ 0.25 sec; □ 0.5 sec; □ 0.8 sec; □ 1.0 sec; □ 1.5 sec; □ 3.0 sec								
Pick-up voltage (V)	15.6–20.4	31.2–40.8	65–85	78–102	143–187	65–85	130–170	247–323	
Drop-out voltage (V)	10.8–16.8	21.6–33.6	45–70	54–84	99–154	45–70	90–140	171–260	
Trip function	With open circuit of DT1, DT2 terminals								
Power consumption (VA)	20								
Order information	Art. no.	203341	203342	203343	203344	203345	203346	203347	203348
Accessories	UVT-Coil Art. no. 168525; UCON lable Art. no. 168526								

Notes:

Please order for each UCON one UVT-Coil, for delay setting one UCON lable.

In case of 380–460V AC, the external unit is attached.

The operating time is a guarantee value when it drops from 85 % or more of rated voltage.

Time delay should be allowed for 1.5 s between applying the voltage to the UVT and closing the breaker.

If a remote trip function is required, remove the shorting bar (DT1 DT2) and connect anormally closed switch, rated 0.5 A at 150 V DC across them.

Usage ambient temperature is a range of max. 40 °C to -5 °C.

Closing coil (CC)

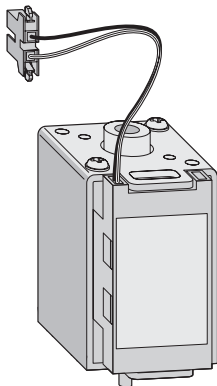

The closing coil is a device to close the breaker by remote control. Only one closing signal (about 100 msec.) is sent even when the closing coil supply is maintained ON.

- An interlock to prevent pumping is provided electrically.

- Closing time is from the initial energization of the closing coil to the completion of the closing of the main contacts.
- As CC is one-pulse driven, it is not necessary to insert AXb for burning prevention purposes. Inserting AXb will cause anti-pumping function to be ineffective.

Specifications	CC-D048-W	CC-AD250-W	
Rated voltage (V)	24–48 DC	100–250 AC/DC	
Applicable voltage range (V)	18–52.8	75–275	
Operating voltage (V)	24 / 48	100 / 250	
Inrush current	AC (A)	0.7 / 1.7 (AC 100 V 100 VA, AC 250 V 200 VA)	
	DC (A)	3 / 6 (DC 24 V 100 W, DC 48 V 200 W)	
Closing time ^① (sec)	max. 0.08 or less	max. 0.08 or less	
Order information	Art. no.	168521	168520

^① In case of double rating of rated voltage, it is the value to the lower rating.
Example: In case of DC24 to 48, it is operating time to DC24V.

Shunt trip device (SHT)

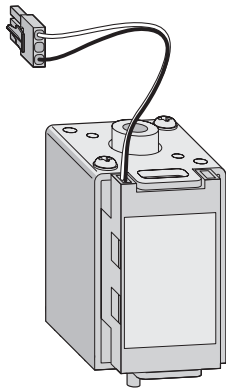

The shunt trip device is used to open the breaker by remote control.

A cut-off switch is included (AX /HAX) is required.

Specifications		SHT-D048-W	SHT-A500-W	SHT-AD250-W
Rated voltage	(V)	24–48 DC	380–500 AC	100–250 (AC/DC)
Applicable voltage range	(V)	16.8–52.8	266–550	70–275
Operating voltage	(V)	24 / 48	380–500	100 / 250
Inrush current (peak value)	AC (A)	—	0.5 / 0.7 (AC 380 V 250 VA, AC 500 V 300 VA)	0.4 / 1.4 (AC 100 V 100 VA, AC 250 V 150 VA)
	DC (A)	2.5 / 6.0 (DC 24 V 100 W, DC 48 V 200 W)	—	0.6 / 1.6 (DC 100 V 100 W, DC 250 V 200 W)
Closing time ^①	(sec)	max. 0.04 or less	max. 0.04 or less	max. 0.04 or less
Order information	Art. no.	168524	168523	168522

^① In case of double rating of rated voltage, it is the value to the lower rating.
Example: In case of DC 24 to 48, it is operating time to DC 24 V.

Auxiliary switch (AX, HAX)

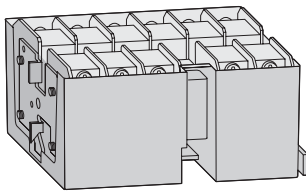

This is the contact that is used to remotely indicate the ON or OFF status of the breaker.

- The a and b contacts may turn simultaneously to ON instantaneously at the time of changing the contact; Pay attention to the contact state when designing circuits.

- The chattering time at the time of contact ON-OFF is below 0.025 sec.
- For special environment specification, the contact capacity gets deteriorated. Apply for further detail.

Specifications		AX-10-W		HAX-10-W			
Contact capacity	(A)	AC	Resistance load	Inductive load	Resistance load	Inductive load	
			460 V	5	2	5	2.5
			250 V	10	10	10	10
		125 V	10	10	10	10	
		250 V	0.3	0.3	3	1.5	
		DC	125 V	0.6	0.6	10	6
	30 V	10	6	10	10		
Maximum number of contacts		5a5b		5a5b			
Order information	Art. no.	168962 (standard)		168961			

Counter (CNT)

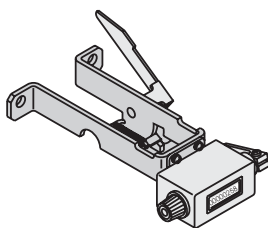

This is a mechanical counter which registers the total number of operating cycles (with 1 ON/OFF switching operation = 1 operating cycle).

The number of operating cycles is displayed on the front of the unit.

Specifications	CNT-W	
Counter type	Mechanical	
Display	5 digits	
Order information	Art. no.	168538

ACCESSORIES ///

ACCESSORIES

2

Cell switch (CL)

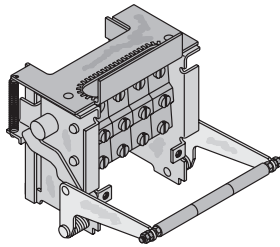

The cell switches can be set for all the relevant positions, i.e. connected, test and disconnected.

Each cell switch consists of 4 individual switches.

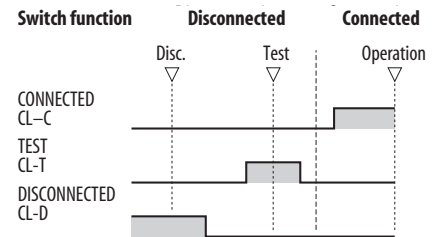

Specifications		CL-4-W		BIF-CL-W	
		Resistive	Inductive	Resistive	Inductive
Contact capacity (A)	AC 460	5	2.5	5	2.5
	AC 250	10	10	10	10
	AC 125	10	10	10	10
	DC 250	3	1.5	3	1.5
	DC 125	10	6	10	6
	DC 30	10	10	10	10
Maximum contacts		Total 4c			

Order information	Art. no.	168512	168575
-------------------	----------	--------	--------

*BIF-CL only necessary for networks operation

Interlock device (CYL)

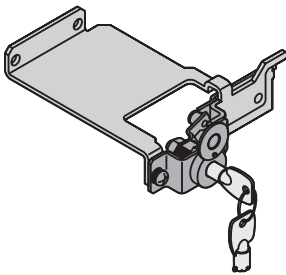

The interlock device locks the circuit breaker into the OFF position. The relevant key can only be taken out in the OFF position of the circuit breaker, so that it can also be used for unlocking other breakers.

There are two locking options available:

- Cylinder lock (CYL)
- Castell lock (CAL) *

Specifications	CYL-WK-W	CYL-WK1-W	CYL-WK2-W	CYL-WK3-W	CYL-WK4-W	CYL-NK-W
Interlock	Cylinder	Cylinder	Cylinder	Cylinder	Cylinder	Castell
Closing	Basic	1	2	3	4	Basic

Order information	Art. no.	168539	168540	168541	168542	168543	168544
-------------------	----------	--------	--------	--------	--------	--------	--------

* The closing basis for the Castell lock can be designed individually. Further details on request.

Safety shutters (SST)

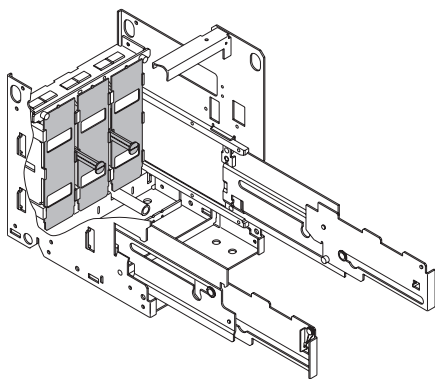

The safety shutters cover the main conductors of the cradle side (supply and load side) automatically when the circuit breaker is drawn out.

When checking the main circuit, the safety shutters on the supply and load sides can be opened independently of one another.

The safety shutters can also be locked with a mechanical locking device (SST LOCK). The padlocks have to be supplied by customer.

Specifications	SST-LOCK-W	SST-203-W	SST-204-W	SST-403-W	SST-404-W	
Breaker type	Drawout					
Number of poles	3/4	3	4	3	4	
Order information	Art. no.	168510	168973	168974	168975	168976

Mis-insertion preventor (MIP)

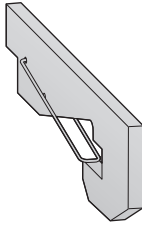

To obtain the right drawout configuration, it is extremely important that the breaker unit specifications (type, current rating, optional accessories, etc.) should match the cradle.

Mis-insertion is prevented by a combination of matching components (on the breaker and the cradle).

Specifications		MIP-W
Material		Metal
Order information		Art. no. 168547

Shorting b-contact (SBC)

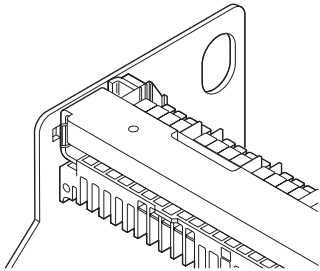

When moving the breaker from the connected to the test positions, this contact is used to short circuit auxiliary switch (Axb) thus maintaining the correct sequence of operation of the external control circuit.

When ordering, the same number of shorting b-contacts as auxiliary switches (AXb) will be provided.

Specifications	SBC-1-W	SBC-2-W	SBC-3-W	SBC-4-W	SBC-5-W
Application (breaker)	All breaker				
Order information	Art. no. 168548	202337	202338	202339	202340

Vertical terminal adapter (VTA)

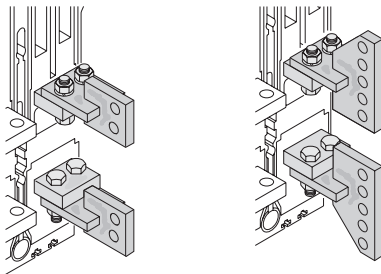

Vertical terminal adapters allow you to turn power connection by 90°.

For AE2000-SWA, AE4000-SWA, AE4000-SW, AE5000-SW and AE6300-SW models, vertical terminal only is available.

Specifications	VTA-02-W	VTA-03-W	VTA-32-W
Application (breaker)	AE1000–AE1600-SW	AE2000–2500-SW	AE3200-SW
Shipping contents	pieces 1	1	1
Order information	Art. no. 168978	168979	168980

Front terminal adapter (FTA)

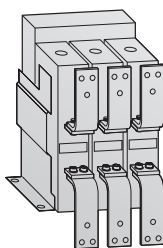

Front terminal adapters FTA allows a vertical connection for supply-and load-busbars.

Specifications	FTA-163F-W	FTA-164F-W	FTA-253F-W	FTA-254F-W	FTA-323F-W	FTA-324F-W	FTA-163D-W	FTA-164D-W	FTA-253D-W	FTA-254D-W	FTA-323D-W	FTA-324D-W
Application (breaker)	AE1000–AE1600-SW	AE1000–AE1600-SW	AE2000–AE2500-SW	AE2000–AE2500-SW	AE3200-SW	AE3200-SW	AE1000–AE1600-SW	AE1000–AE1600-SW	AE2000–AE2500-SW	AE2000–AE2500-SW	AE3200-SW	AE3200-SW
Pole	3	4	3	4	3	4	3	4	3	4	3	4
Typ	Fixed	Fixed	Fixed	Fixed	Fixed	Fixed	Drawout	Drawout	Drawout	Drawout	Drawout	Drawout
Shipping contents	pieces 6	8	6	8	6	8	6	8	6	8	6	81
Order information	Art. no. 169331	169332	169333	169334	169335	169336	169337	169338	169339	169340	169341	169342

ACCESSORIES ///

2 ACCESSORIES

■ Mechanical interlock (MI)

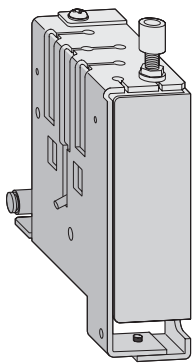

This is the device to prevent parallel charge of 2 or 3 units of breakers, and it can interlock the breakers mechanically without fail. All combinations are available among any models from AE1000-SW to AE4000-SWA.

Please apply for further details of AE4000-SW – AE6300-SW.

Further the interlock is possible among the different connection types or poles, such as fixed type or drawout type, 3 pole or 4 pole. In combination with electric interlock, the higher safety interlock system can be secured.

- In case of drawout type, the interlock works at "CONNECTED" position, and in another position the interlock is released, which is convenient for and easy maintenance and inspection of the breaker.
- When to turn OFF one breaker and then turn ON another breakers, please take an interval 0.5 seconds or more.
- MI for 3 breakers can not be installed to combine with Door Interlock (DI).

Vertical mounting

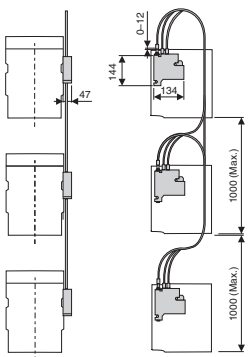

[mm]

Horizontal mounting

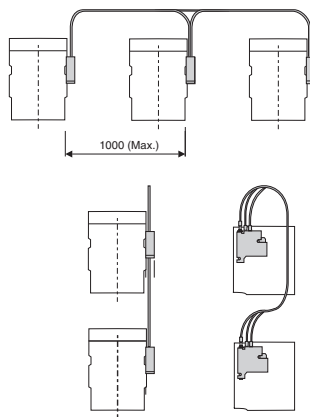

Switching states (for 2 ACBs)

Type	①	②	③
ACB 1	○		○
ACB 2	○	○	

Type	①	②	③	④
ACB 1	○		○	○
ACB 2	○	○		○
ACB 3	○	○	○	

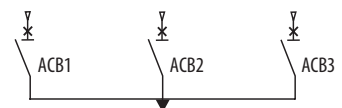

Switching states (for 3 ACBs)

Type	①	②	③	④	⑤	⑥	⑦
ACB 1	○		○	○			○
ACB 2	○	○		○		○	
ACB 3	○	○	○		○		

Type	①	②	③	④	⑤
ACB 1	○		○		○
ACB 2	○	○		○	○
ACB 3	○	○	○		

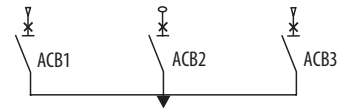
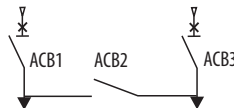

Specifications	MI-203F-W	MI-204F-W	MI-403F-W	MI-404F-W	MI-203D-W	MI-204D-W	MI-403D-W	MI-404D-W	MI-IW-W	
Application (breaker)	AE1000–1600-SW AE2000-SWA		AE2000–3200-SW AE4000-SWA		AE1000–1600-SW AE2000-SWA		AE2000–3200-SW AE4000-SWA		Wire set for all mechanical Interlock devices required for combination of 3ACB	
Breaker type	Fixed				Drawout					
Number of poles	3	4	3	4	3	4	3	4		
Order information	Art. no.	168963	168964	168965	168966	168967	168968	168969	168970	168971

■ Door interlock (DI)

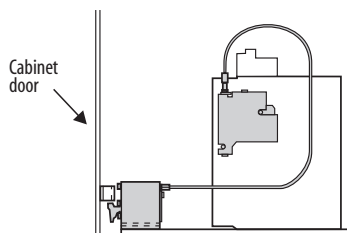

This mechanical interlock device makes it impossible to open the panel door unless the circuit breaker is not switched off.

The device has been designed for panel doors with the groove on the left (standard). Locks for grooves on the right are available on request.

A wire-type mechanical interlock is used to allow flexibility in positioning breakers in the panel.

Note:

When using the door interlock (DI) the application of the mechanical interlock (MI) is not possible.

Specifications	DI-F-W	DI-D-W	
Application (breaker)	For all breakers	For all breakers	
Breaker type	Fixed	Drawout	
Order information	Art. no.	168545	168546

■ Push button cover (BC-L)

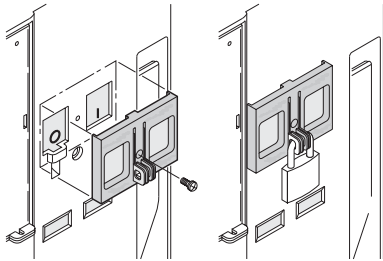

This mechanical device can be locked with a padlock or a seal (not included in the package) to protect the push buttons of the breaker unit against inadvertent ON/OFF operation.

The padlock has to be supplied by the customer.

Specifications		BCL-W
Material		Acrylic plate
Order information	Art. no.	168537

■ Dust cover (DUC)

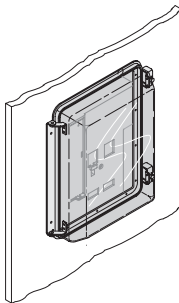

The transparent dust cover is hinged onto the panel door. It has a screw lock and prevents dust and water entering into the circuit breaker.

Specifications		DUC-W
Protection		IP 54
Order information	Art. no.	168960

■ Terminal cover (TTC)

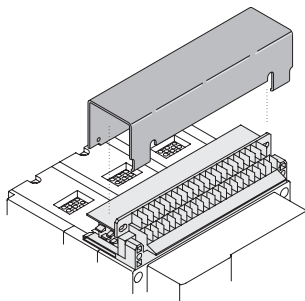

The terminal cover is a transparent cover for safety finger protection of control terminals.

The terminal cover prevents from careless touching to the live control terminals.

The TTC-F-W is included within the delivery of a fixed type AE-SW.

Specifications		TTC-D-W	TTC-F-W
Application (breaker)		Drawout type	Fixed type
Protection		IP 20	IP 20
Order information	Art. no.	168549	168972

■ Door frame (DF)

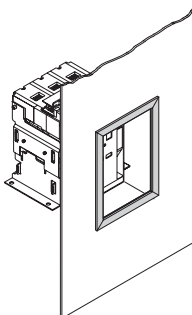

The door frame improves the appearance, after cutting out the panel door to install the breaker.

Refer to the overall dimension drawings on page 36 ff for the installation method.

Specifications		DF-SAE
Application (breaker)		For all breakers
Material		Plastic
Protection		IP 20
Order information	Art. no.	28319

ACCESSORIES ///

ACCESSORIES

2

Current transformer (CT)

These current transformers (CT and sensor coil) are suitable for the main conductor and the N conductor.

Current transformers of type CT-06□□□ serve the reduction of $I_{n,max}$ on an AE 1000.

Specifications	CT-06-W 025	CT-06-W 031	CT-06-W 050	CT-06-W 063	CT-10-W 100	CT-12-W 125	CT-16-W 160	CT-20-W 125	CT-20-W 160	CT-20-W 200	CT-25-W 250	CT-32-W 320
Application (breaker) *	AE1000-SW	AE1000-SW	AE1000-SW	AE1000-SW	AE1000-SW	AE1250-SW	AE1600-SW	AE2000-SW	AE2000-SW	AE2000-SW	AE2500-SW	AE3200-SW
Rated current $I_{n,max}$ ** (A)	250	315	500	630	1000	1250	1600	1250	1600	2000	2500	3200
Order information	Art. no.	193939	193940	193941	193942	193943	193944	193945	193946	193947	193948	193949

More CTs on request.

* Shipping contents includes CT and sensor coil for 1 pole. Other transformers on request.

** At 40°C and 50/60 Hz

Neutral current transformer (NCT)

Block diagram with NCT function

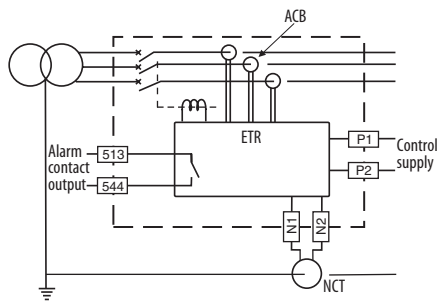

The neutral CT is used for ground fault protection when a 3 pole breaker is used on a 3 phase 4 wire system.

The Ground fault protection module type G1 should be used as optional setting module.

Specifications	NCT-06	NCT-10	NCT-12	NCT-16	NCT-20	NCT-25	NCT-32	NCT-40
Application (breaker)	AE630-SW	AE1000-SW	AE1250-SW AE2000-SW	AE1600-SW AE2000-SW	AE2000-SWA AE2000-SW	AE2500-SW	AE3200-SW	AE4000-SWA
Current range (A)	630	1000	1250	1600	2000	2500	3200	4000
Order information	Art. no.	168986	168987	168988	168989	168990	168991	168992

External current transformer (ZCT/ZT)

Transformer ground wire method (ZT)

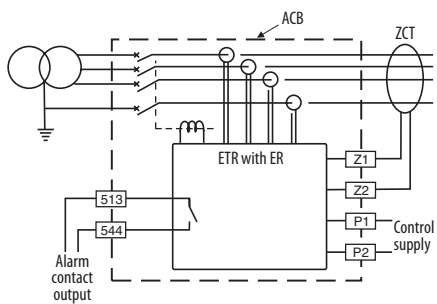

Transformer ground wire method (ZT)

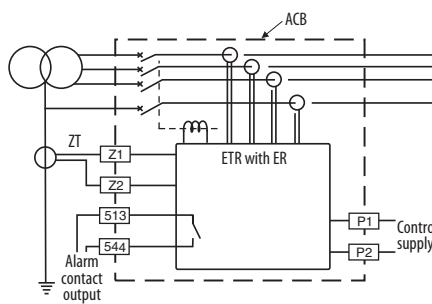

This option is used to detect several amperes of earth leakage when used in combination with an electronic trip relay that has the earth leakage tripping (ER) option.

Two methods are available:

- **ZCT:** three-load phase conductors (and the neutral conductor in a 4-wire system) are passed through the ZCT. The other method uses a smaller ZCT (only supply transformer ground wire passes through to earth).

Specifications	ZCT-163-W	ZCT-323-W	ZCT-324-W	ZT-15B-W	ZT-30B-W	ZT-40B-W	ZT-60B-W	ZT-80B-W	ZT-100B-W
Application	Load circuits			Transformer ground wire					
Hole diameter for wire * (mm)	230x60 (oval)	370x108 (oval)	500x108 (oval)	∅ 15	∅ 30	∅ 40	∅ 60	∅ 80	∅ 100
Order information	Art. no.	168994	168995	168996	168997	168998	168999	169000	169001

Internal power supply unit's (PW)

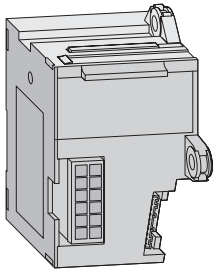

These powersupplies are used for supplying the ETR base unit. They are equipped with 6 outputs (alarms and errors).

The PW3-W is included as standard powersupply in the ACB's.

Specifications	PW3-W	PW4-W	PW5-W
Power supply (V)	100-240 (AC) 100-125 (DC)	24 - 60 (DC)	100 - 250 (DC)
Output contacts	6	6	6 (SSR)
Order information	Art. no. 168985	168562	168562

Field test devices

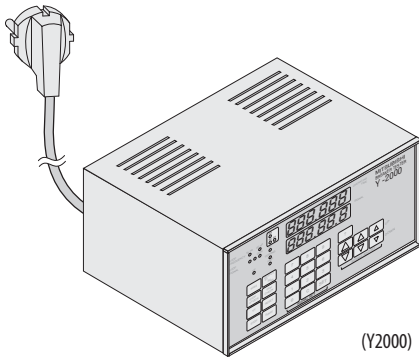

(Y2000)

The test devices are for testing the functioning of the electronic trip relay.

It allows you to test the trip relay without the breaker being connected to the main supply. The breaker will trip when tested.

Specifications	Y-2000
Test functions	LTD, INST, STD, Groundfault, pre-alarm
Power supply *	100-240 V (AC)
Test current signal setting	Continuously variable (10 - 2000 %)
Others	Ammeter, time counter
Order information	Art. no. 27496

* Rated frequency at AC = 50/60 Hz

Test jumper (TJ)

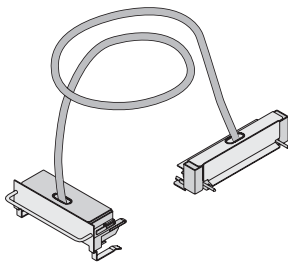

The test jumper cable is for testing the functioning of the circuit breaker when the unit is removed from its cradle. Take the breaker out of its cradle and use this cable to switch the breaker on and off electrically, so that you can check all its functions.

Specifications	Test Jumper	
Cable length (m)	3 *	
Order information	Art. no. 168977	

* Other lengths on request

Interphase barrier

Connections		AE1000-SW – AE1600-SW	AE2000-SWA	AE2000-SW – AE3200-SW	AE4000-SWA
Fixed type	Horizontal (FIX)	●	×	●	×
	Vertical terminal (FIX-VT)	×	▲	×	▲
	Vertical terminal adaptor (VTA)	▲	×	▲	×
	Front terminal adaptor (FIX-FTA)	▲	×	▲	×
Drawout type	Horizontal (DR)	●	×	●	×
	Vertical terminal (DR-VT)	●	▲	▲	▲
	Front terminal (DR-FT)	—	×	▲	×
	Vertical terminal adaptor (VTA)	▲	×	▲	×
	Front terminal adaptor (DR-FTA)	▲	×	▲	×

● = Available for the insulation ▲ = Available for separating terminals × = Not existing type — = Attachment is impossible
For AE4000-SW to AE6300-SW not available

ELECTRONIC TRIP RELAY ///

Introduction and selection

Power supply module

This module provides control source for DISPLAY module, Trip indicator and several indicators (LEDs). (Even when the control power source is off, the function of over current protection and ground fault protection are effective.)
The power supply function supplies output contact (6 contacts) (see page 22).

Display

Several measuring data (current, voltage, power etc) and alarms can be displayed with this module. (see page 28)

RUN LED, ERR. LED(standard)

This indicator displays the ETR situation (Run or Error)

Extension module

This module is required when installed VT-W unit, display module and each interface unit.

Load current LED (standard)

This indicator displays the maximum current of phase.

Pre-alarm(PAL) (standard)

This indicator displays the Pre-Alarm situation when exceed the setting current. When it installed power supply module with contact, the output contact of Pre-Alarm is available.

*The output is reset when the electric current goes below the set level after an alarm is set off

Main setting module

This module provides the function of over current protection. It is possible to select the three setting module according to application. (see page 26)
Neutral protection of rated current (100%) function is standard at 4 pole breaker.

Trip indicator LED(standard)

This indicator displays the trip cause.

Optional setting module (option)

Additional functions and characteristics can be selected by optional setting modules (see page 26).

TEST terminal(standard)

This terminal already installed as standard. This terminal is used for testing by the field test device (Y-2000).

RESET button(standard)

When push this reset button, trip indicator, and Pre-Alarm will be resetted. And when the instantaneous test by MITSUBISHI special tester and push this reset button, as a result of LTD and STD function become ineffective.

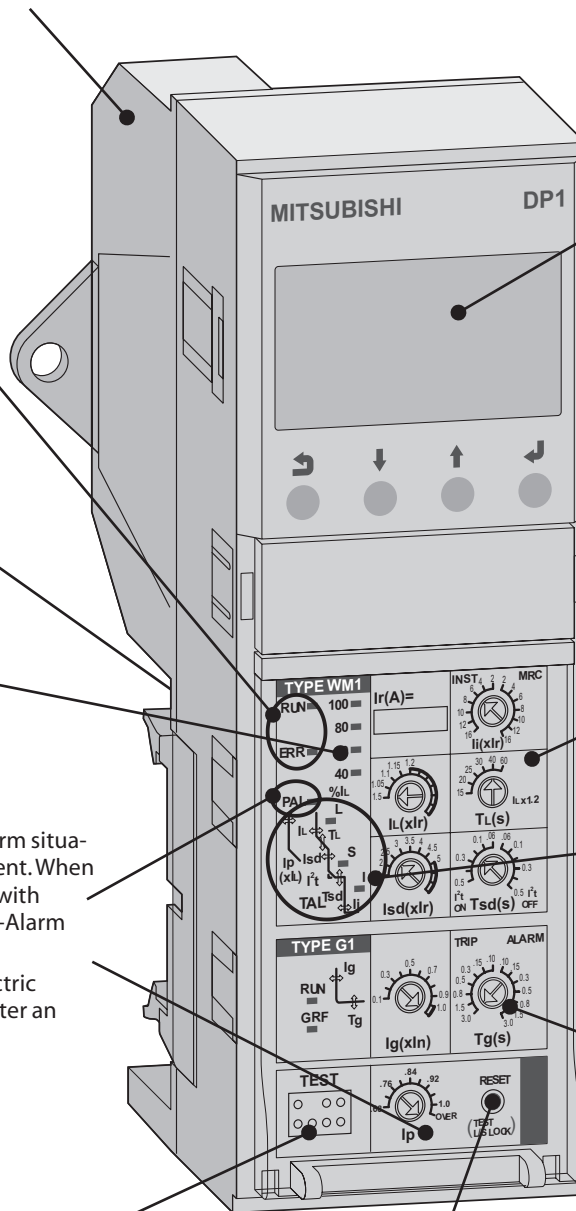

3

ELECTRONIC TRIP RELAY

Standard functions

■ OCR alarm (AL)

When it happen to trip by over current, ground fault (GFR) and Earth leakage (ER), it issue a warning alarm.

■ Neutral pole overcurrent protection (NP)

When harmonics in load current are large, the current on neutral pole exceeding rated current may flow. Harmonics may causesome troubles. Neutral pole

overcurrent protection prevents them by operating at 100% of rated current on neutral pole. Please see page 27 for 50 % neutral protection.

Special Functions – Optional

■ MCR: Making current release

Just under the breaker closing operation (from open to close), Instantaneous characteristic become effective, but after closing the breaker, instantaneous characteristic become ineffective.

When you order the MCR switch, MCR switch is built in the main body. If MCR switch is built in the main body and the adjust dial of INST/MCR on main

setting module is set the MCR position, MCRfunction become effective.

■ NCT

Neutral CT is required for Ground fault or Neutral pole protection, when 3 pole breaker is used for 3 phase 4 wires system. (see page 18)

■ ZCT

ZCT is required for a few amperes earth leakage protection, and is combining ER plug. (see page 18)

ELECTRONIC TRIP RELAY ///

Characteristic table

	General protection Nothing	G1 Ground fault	E1 Earth leakage	AP 2nd additional Pre-alarm	N5 Neutral pole 50% protection
WS General use LTD+STD+INST/MCR					
WM Generator protection use LTD+STD+INST/MCR					

3

ELECTRONIC TRIP RELAY

Power supply module

Type	Rating	Alarm output
P3	100–240 V AC 100–125 V DC	6 output contacts
P4	24–60 V DC	6 output contacts
P5	100–240 V AC	6 output contacts (SSR)

Notes:

Over current protection and ground fault protection operates without control power source.

Factory setting of 6 output contacts is as follows.

LTD	STD/INST	G1/E1/AP	PAL	TAL	ERR
Self-holding	Self-holding	Refer to lower table	Non Self-holding	Non Self-holding	Non Self-holding

Contact capacity (Type code P3, P4)

Voltage (V)	Resistive load		Inductive load	
	$\cos\phi = 1.0$		$\cos\phi = 4.0$ L/R = 7ms	
AC	240	1A	0.5A	
	120	1A	1A	
DC	125	0.1A	0.05A	
	30	1A	1A	

Contact capacity (Type code P5)

Voltage (V)	Normal current	Peak inrush current	ON resistance (max.)	
AC	240	0.1A	0.3A	5Ω
	120	0.1A	0.3A	5Ω
DC	125	0.1A	0.3A	5Ω
	30	0.1A	0.3A	5Ω

ETR dial set	G1	E1	AP
TRIP side	Self-holding	Self-holding	—
ALARM side	Non Self-holding	Non Self-holding	Non Self-holding

Self-holding type: The output condition is held until it is reset.

Non self-holding type: The output is reset if it is returned to the normal condition.

CT rating table

AE1000-SW				AE1250-SW	AE1600-SW	AE2000-SWA	AE2500-SW	AE3200-SW	AE4000-SWA	AE5000-SW	AE6300-SW
1000A				1250A	1600A	2000A	2500A	3200A	4000A	5000A	6300A
250A	315A	500A	630A			AE2000-SW			AE4000-SW		
						2000A			4000A		
						1250A	1600A				

Notes:

AE630-SW and AE2000-SW has low rating type.

Low rating type of AE630-SW is not available for the ground fault protection.

As for details of ratings, refer to page 9.

Electronic trip relay (ETR configuration overview)

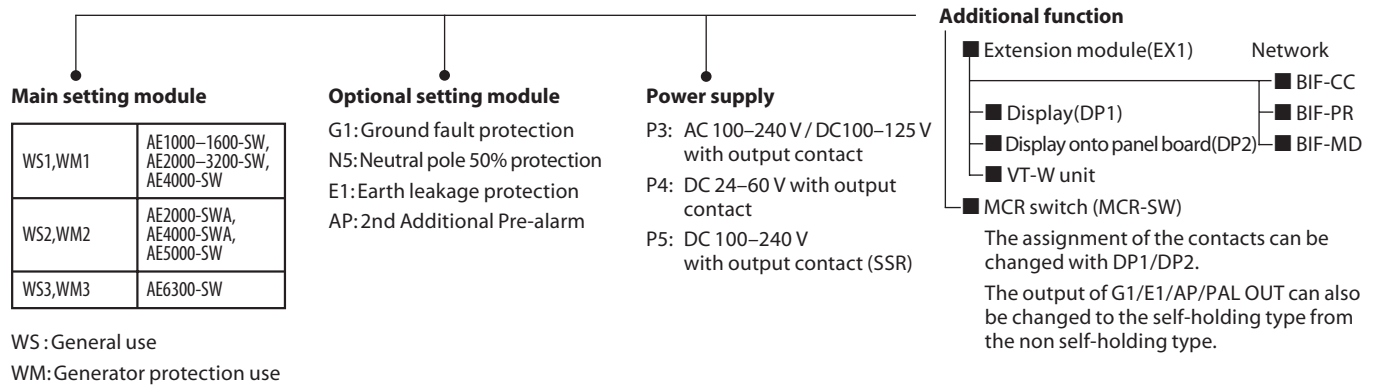

ELECTRONIC TRIP RELAY ///

S Types – General Protection

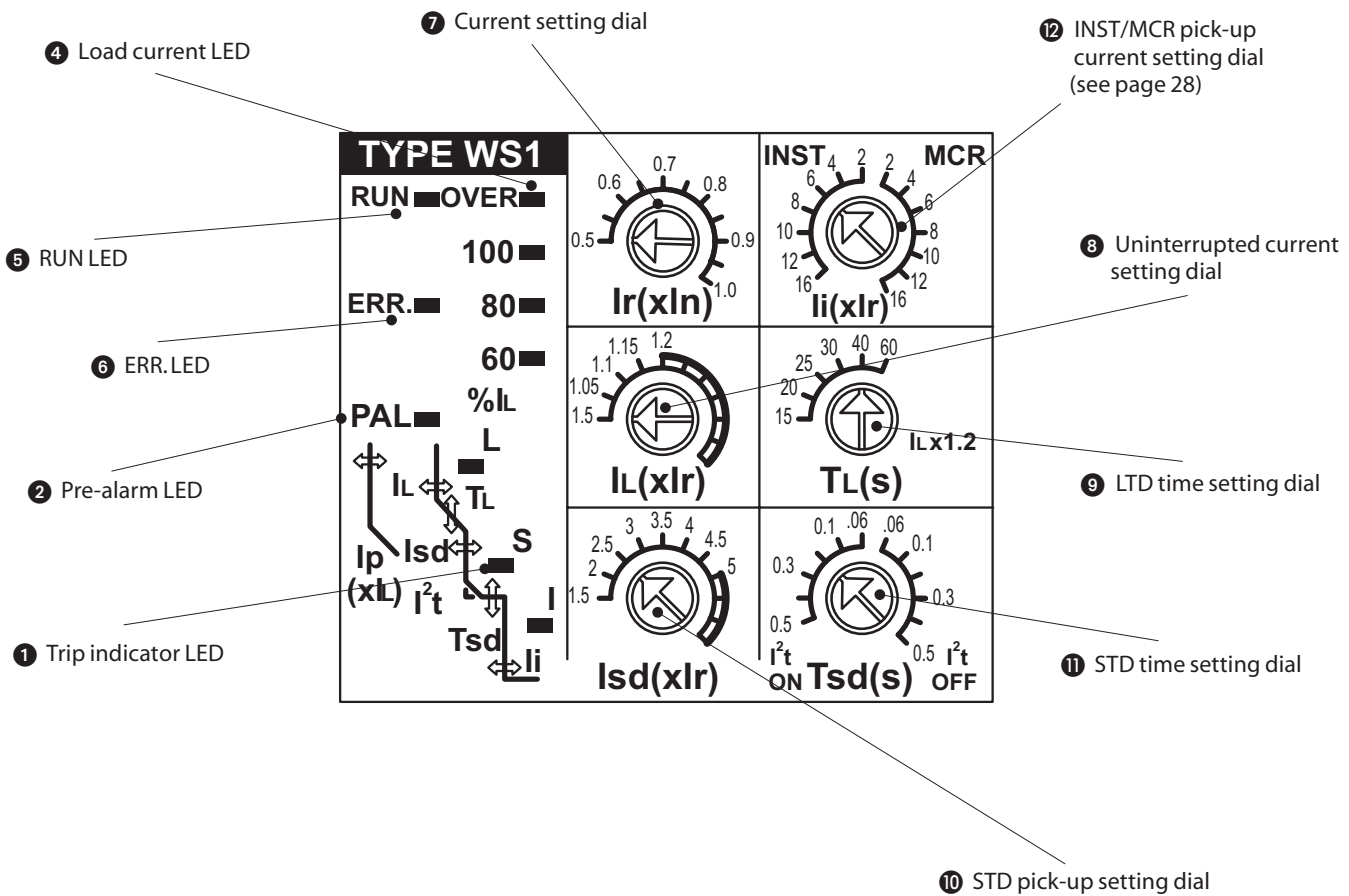

ELECTRONIC TRIP RELAY

3

Adjustable setting range

Number	Setting item	Adjustable setting range	Accuracy	Setting for shipment
7	Current setting	I_r 0.5 – 1.0 (0.05 step) x in (CT rating)	—	1.0
8	Uninterrupted current	I_u 0.8 – 1.0 x I_r (0.02 step), Pick-up current: 1.15 x I_u	1.05 x I_u ... Non Pick-up 1.25 x I_u ... Pick-up	1.0
9	LTD time	T_L 12–25–50–100–150s at I_u x 2	± 20%	150
10	STD pick-up current	I_{sd} 1.5–2–2.5–3–4–5–6–7–8–9–10 x I_r	± 15%	10
11	STD time	T_{sd} 0.5–0.4–0.3–0.2–0.1–0.06 (I ² t ON) 0.06–0.1–0.2–0.3–0.4–0.5s (I ² t OFF)	± 20% It operates in the range between 0.04 and 0.08s when the time set at 0.06s.	0.5 (I ² t ON)
12	INST/MCR pick-up current	AE1000-SW–AE1600-SW AE2000-SW–AE3200-SW AE4000-SW AE2000-SWA, AE4000-SWA AE5000-SW AE6300-SW	WS1 WS2 ± 15% WS3	WS1... 16 (INST) WS2... 12 (INST) WS3... 10 (INST)
14	Pre-alarm current	I_p I_u x 0.68 – 1.0 (0.04 step) – OVER	± 10%	OVER
—	Pre-alarm time	T_p 1/2 T_L (after 1/2 T_L , PAL contact output turns on.)	± 20%	—

Upper figure and table denote that are include optional MCR function. Pre-alarm current "OVER" setting is equal to 1.0.

Specifications	WS1-W	WS2-W	WS3-W
Main setting Module	WS1	WS2	WS3
Order information	Art. no. 168552	168553	205180

M Types – Generator Protection

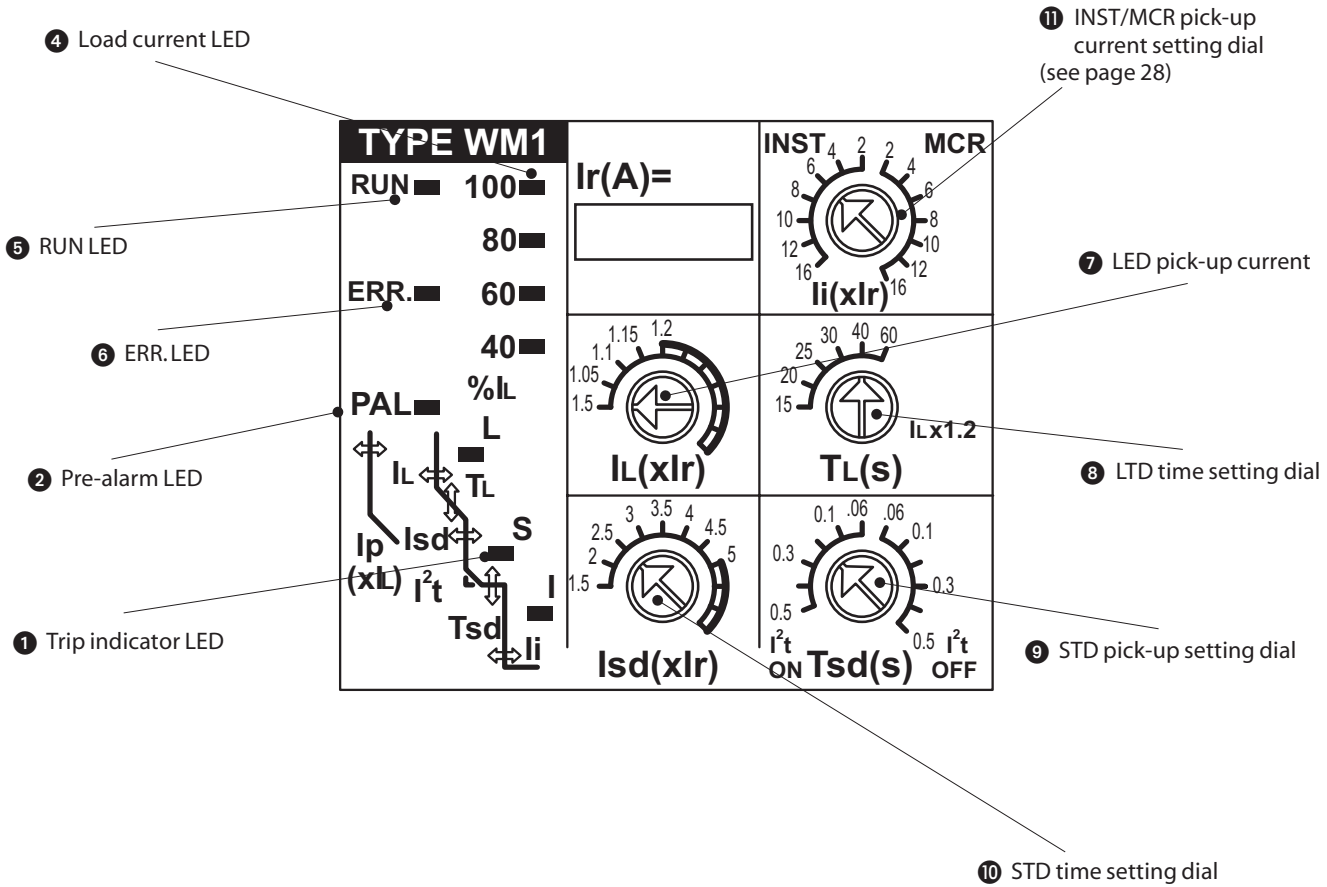

3
ELECTRONIC TRIP RELAY

Adjustable setting range

Number	Setting item	Adjustable setting range	Accuracy	Setting for shipment	
—	Current setting	I_r 0.63 – 1.0 x I_n (Adjust by factory : Fixed)	—	Comply with ordering sheet	
7	LTD pick-up current	I_L 1.0–1.05–1.1–1.15–1.2 x I_r	± 5%	1.15	
8	LTD time	T_L 15–20–25–30–40–60s at I_L x 1.2	± 20%	20	
9	STD pick-up current	I_{sd} 1.5–2–2.5–3–3.5–4–4.5–5 x I_r	± 15%	5	
10	STD time	T_{sd} $\frac{0.5-0.4-0.3-0.2-0.1-0.06}{(I^2t \text{ ON})}$ $\frac{0.06-0.1-0.2-0.3-0.4-0.5s}{(I^2t \text{ OFF})}$	± 20% h operates in the range between 0.04 and 0.08s when the time set at 0.06s.	0.5 (I²t ON)	
11	INST/MCR pick-up current	AE1000-SW–AE1600-SW AE2000-SW–AE3200-SW AE4000-SW	$\frac{16-12-10-8-6-4-2}{(INST)}$ $\frac{2-4-6-8-10-12-16}{(MCR)}$ x I_r	WM1	WM1...16 (INST)
		AE2000-SWA, AE4000-SWA AE5000-SW	$\frac{12-10-8-6-4-2}{(INST)}$ $\frac{2-4-6-8-10-12}{(MCR)}$ x I_r	WM2	± 15% WM2...12 (INST)
		AE6300-SW	$\frac{10-8-6-4-2}{(INST)}$ $\frac{2-4-6-8-10}{(MCR)}$ x I_r	WM3	WM3...10 (INST)
13	Pre-alarm current	I_p I_L x 0.68 – 1.0 (0.04 step) – OVER	± 5%	OVER	
—	Pre-alarm time	T_p 1/2 T_L (after 1/2 T_L , PAL contact output turns on.)	± 20%	—	

Upper figure and table denote that are include optional MCR function. Pre-alarm current "OVER" setting is equal to 1.0.

Specifications	WM1-W	WM2-W	WM3-W
Main setting Module	WM1	WM2	WM3
Order information	Art. no. 168554	168555	205181

ELECTRONIC TRIP RELAY ///

Ground fault protection (GFR)

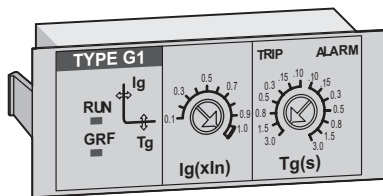

The ground fault protection (GFR) of several hundred amperes is possible. This function can be selected for trip and alarm (no trip). Power supply is necessary for this function, even if there is not power supply, it can function at 0.2 x In or higher.

Specifications	G1-W
Optional setting Module	G1 (Ground fault protection module)
Order information	Art. no. 168558

3

ELECTRONIC TRIP RELAY

Setting item	Adjustable setting range	Accuracy	Setting for shipment
GFR pick-up current	I_g 0.1-0.2-0.3-0.4-0.5-0.6-0.7-0.8-0.9-1.0 x I_n	±20%	1.0
GFR time	T_g 3-1.5-0.8-0.5-0.3-0.15-<0.1 - <0.1-0.15-0.3-0.5-0.8-1.5-3s (at 1.5 x I_g) TRIP ALARM	±20%	3s (TRIP)

2nd Additional Pre-alarm (AP)

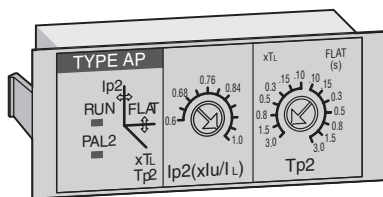

The Pre-Alarm (1st) function already installed in standard breaker, the 2nd additional Pre-Alarm function can be installed as option, thereby it is possible to monitor (observer) electric circuit in more detail by 2nd additional Pre-Alarm function.

Specifications	AP-W
Optional setting Module	AP (2nd Pre-alarm module)
Order information	Art. no. 168560

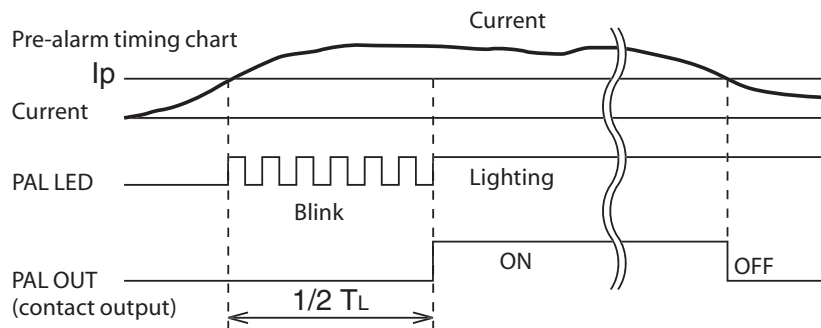

Setting item	Adjustable setting range	Accuracy	Setting for shipment
2nd additional Pre-alarm pick-up current	I_{p2} 0.5-0.6-0.7-0.8-0.84-0.88-0.92-0.96-1.0 x I_u (WS) 0.5-0.6-0.7-0.8-0.84-0.88-0.92-0.96-1.0 x I_L (WM)	±10% (WS) ±5% (WM)	1.0
2nd additional Pre-alarm time	T_{p2} 0.3-0.4-0.5-0.6-0.7-0.8-0.9 x T_L / 5-10-15-20-30-40-60s (FLAT)	±20%	0.9 x T_L

Neutral pole 50% protection (N5)

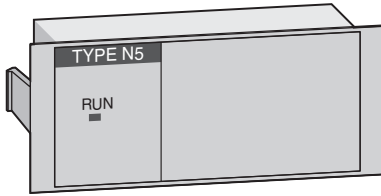

Neutral pole overcurrent protection (operating at 100% of rated current) already installed in standard ETR.

But if you would like to operate at 50% of rated current on neutral pole, neutral pole 50% protection realizes it.

Specifications		N5-W
Optional setting Module		N5 (Neutrale pole protection module)
Order information	Art. no.	168561

Earth leakage protection (ER)

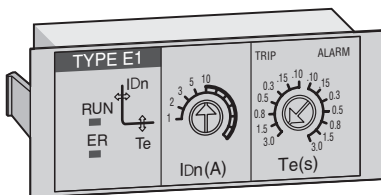

By combining the ETR with earth leakage protection (ER) and External ZCT, earth leakage protection is possible. Earth leakage protection, earth leakage tripping and earth leakage alarm can be selected. Control supply is necessary for this function.

Specifications		E1-W
Optional setting Module		E1 (Earth leakage protection module)
Order information	Art. no.	168559

Setting item	Adjustable setting range	Accuracy	Setting for shipment
ER pick-up current	$I_{\Delta n}$ 1-2-3-5-10A	+0% -30%	10A
ER time	T_e 3-1.5-0.8-0.5-0.3-0.15-<0.1 - <0.1-0.15-0.3-0.5-0.8-1.5-3s (at 1.5 x $I_{\Delta n}$) TRIP ALARM	±20%	3s (TRIP)

MCR switch (MCS-W)

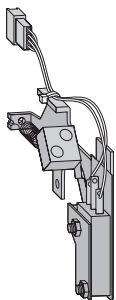

If MCR switch is built in the breaker and the dial for INST/MCR on Main setting module is set to any MCR position, MCR function is operative.

MCR function: During a closing operation of the breaker, instantaneous characteristics is operative. And it becomes inoperative when the breaker is in the closed position.

Specifications		MCS-W
Switch		MCR
Order information	Art. no.	168570

ELECTRONIC TRIP RELAY ///

ELECTRONIC TRIP RELAY

3

Extension module (EX1)

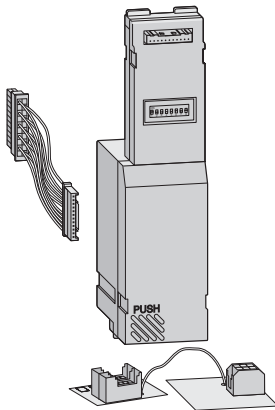

This is the module that realizes various additional functions combining Display module (DP1 / DP2), Interface unit (BIF-CC / BIF-PR / BIF-MD) and VT-W unit.

● Various measuring elements, high measuring accuracy

By adopting high-performance ASIC, various measuring elements (load current, voltage, energy, harmonics, etc.) and high measuring accuracy are realized.

● **Communication function**
2 display modules and 1 interface unit can be connected simultaneously by internal communication.

Specifications	EX1-W	
Type	Extension Module	
Order information	Art. no.	168564

Display module (DP1/DP2)

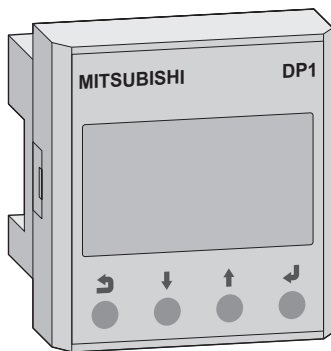

This is the module that displays and sets various information, for example, measurement, trip and alarm, setting of output contacts and so on.

● Multi display of measuring element

It enables to easily monitor the comparison of each measuring element by multi display (load current 4 phases multi display and voltage multi display) on one screen.

● 2-colors back light

If trip or alarm occurred, back light color changes from green to red automatically.

● Graphical display

By adopting dot matrix type LCD, graphical display such as bar graph display of load current, harmonic currents and characteristic curve are realized.

There are 2 types of this module. One is the ETR attachment type (DP1). Another is the panel attachment type (DP2) and is connected to extension terminals of control circuit by 2m cable 5m cable will be available on request.

Specifications	DP1-W	DP2-W
Type	Display module for ETR assembly	Display module for Panel assembly
Order information	Art. no. 168565	168566

Notes

Extension module (EX1) is required.

The VT unit is required to display the measured data except the electric current.

VT-W unit

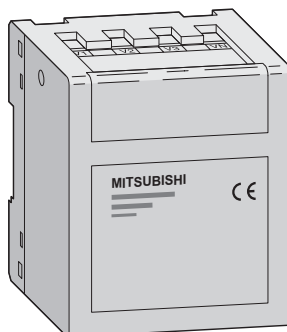

VT-W Unit enables to measure voltages, powers, energies, harmonic currents and etc. by connecting the ETR with Extension module (EX1).

Specifications	VT-W
Unit for	U/P/E/cos phi/earth leakage/average measurings/trip history/trip current measurings
Order information	Art. no. 168567

Interface unit (BIF-CC/BIF-PR/BIF-MD)

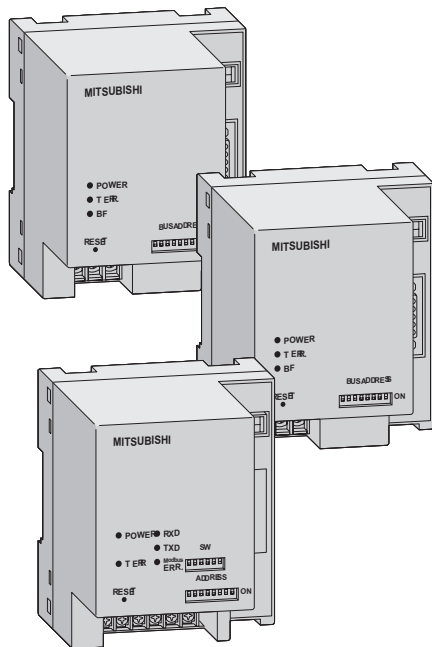

These Interface units can expand the future possibility in various communication and Intelligent control.

- **Applicable to various open networks.**
These units are applicable to various open network systems such as CC-Link®, PROFIBUS-DP and MODBUS® (RS-485), which can be built in easily.

● **Intelligent control by Multi-data communication**

It comes into being the Intelligent control by Multi-data communication through these interface units to PLC/SCADA, which transfer the measurement information, setting values, error information and trip and alarm informations.

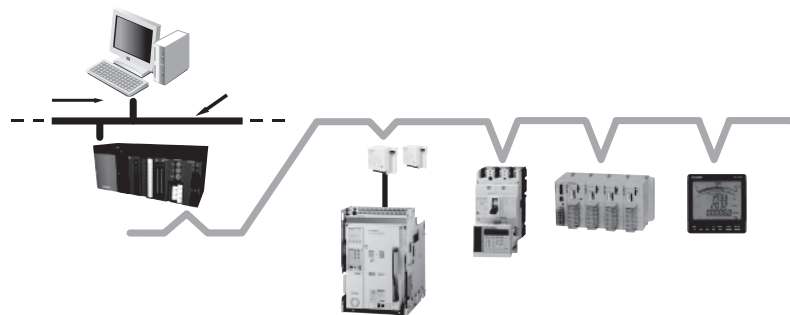

Specifications	BIF-CC-W	BIF-PR-W	BIF-MD-W
Module for	CC-Link network	Profibus DP network	Modbus network
Order information	Art. no. 168571	168572	168573

Notes

Extension module (EX1) is required.

The VT-W unit is required to display the measured data except the electric current.

I/O unit (BIF-CON/BIF-CL)

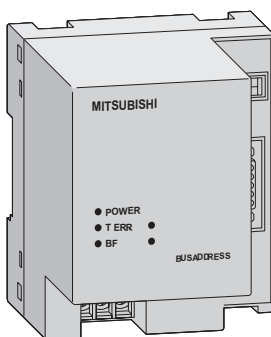

The Input & Output Controlling Unit (BIF-CON) is available for the remote controlling and remote monitoring of the breaker condition through the various network systems. With this BIF-CON in addition to the Interface Unit, it become possible to control the breaker remotely, like a ON or

OFF operations or Spring-charging. Further, by combining the Drawout position switch (BIF-CL), the monitoring of drawout position become available in case of the breaker drawout type.

Function	Description	Note
Control	Breaker ON operation	1a contact for CC.
	Breaker OFF operation	1a contact for SHT. (not applicable for AC380 – 500 V rating)
	Spring charge	1a contact for MD.
Monitor	Digital Input (DI) monitoring	In case of BIF-CC and BIF-MD, Max.3 contacts monitoring are available. In case of BIF-PR, 1 contact monitoring is available.
	Breaker drawout position	Position: CONNECTED, TEST and DISCONNECTED. BIF-CL is required.

Specifications	BIF-CON-W
Unit	I/O unit network module
Order information	Art. no. 168574

ELECTRONIC TRIP RELAY ///

Configuration Table of ETR with EX1 and VT-W module

Combination sample	Display module + Extension module								Display module + Extension module + VT-W unit							
	① = EX1 ② = DP1 - ③ = DP2 ①								① = EX1 ② = DP1 - ③ = DP2,VT-W ①							
Type	WS				WM				WS				WM			
① Main setting module	NP	AP	G1	E1	NP	AP	G1	E1	NP	AP	G1	E1	NP	AP	G1	E1
② Optional setting module																
③ Power supply	P3 - P5								P3 - P5							
Measurement																
Load current (±2.5%)				○				○				○				○
Leakage current (±15%) ③	—	—	—	○	—	—	—	○	—	—	—	○	—	—	—	○
Voltage (±2.5%)				—				—				—				—
Power (active, reactive, apparent) (±2.5%)				—				—				—				—
Power factor (±5%)				—				—				—				—
Energy (active, reactive) (±2.5%)				—				—				—				—
Harmonics current (±2.5%)				—				—				○ (3.5 ... 19th)				—
Frequency (±2.5%)				—				—				—				—
Trip history																
LTD			○				○				○				○	
STD		○				○				○				○		
INST				○				○				○				○
GFR	—	—	○	—	—	—	○	—	—	—	○	—	—	—	○	—
ER	—	—	—	○	—	—	—	○	—	—	—	○	—	—	—	○
UVT				○ ②				○ ②				○ ②				○ ②
Alarm history																
PAL1				○				○				○				○
PAL2	—	○	—	—	—	○	—	—	—	○	—	—	—	○	—	—
OVER				○				○				○				○
GFR	—	—	○	—	—	—	○	—	—	—	○	—	—	—	○	—
EPAL	—	—	—	○	—	—	—	○	—	—	—	○	—	—	—	○
ER	—	—	—	○	—	—	—	○	—	—	—	○	—	—	—	○
Characteristic setting (panel attachment product [DP2] only)																
LTD			○				○				○				○	
STD		○				○				○				○		
INST				○				○				○				○
PAL1				○				○				○				○
PAL2	—	○	—	—	—	○	—	—	—	○	—	—	—	○	—	—
GFR	—	—	○	—	—	—	○	—	—	—	○	—	—	—	○	—
EPAL	—	—	—	●	—	—	●	—	—	—	—	●	—	—	—	●
ER	—	—	—	○	—	—	—	○	—	—	—	○	—	—	—	○
Setting																
Output contacts setting change				●				●				●				●
Date & Time				●				●				●				●
Demand time				●				●				●				●
Alarm holding method				●				●				●				●
Reset																
Trip and alarm information				●				●				●				●
Measurement information (min. and max. values)				●				●				●				●
ETR information																
Main / Optional setting module information				○				○				○				○
Error information				○				○				○				○
CT rating				○				○				○				○
Phase line method				○				○				○				○
Normal connection or reverse connection				○				○				○				○

○: can be displayed by DP1/DP2

●: can be displayed and set by DP1/DP2

① 2 units of display modules can be attached.

② Display is available only when UVT module is attached.

③ Included the accuracy of ZCT.

ELECTRONIC TRIP RELAY 3

A	
Additional Pre-alarm (AP)	26
Auxiliary switch (AX, HAX)	13
C	
Cell switch (CL)	14
Closing coil (CC)	12
Connection arrangements	8
Counter (CNT)	13
Current transformer (CT)	18
D	
Display module (DP1/DP2)	28
Door frame (DF)	17
Door interlock (DI)	16
Dust cover (DUC)	17
E	
Earth leakage protection (ER)	27
ELECTRONIC TRIP RELAY	20
Characteristic table	22
Configuration Table of ETR with EX1 and VT-W module	30
CT rating table	23
Introduction and selection	20
M Types – Generator Protection	25
S Types – General Protection	24
Special Functions – Optional	21
Standard functions	21
Extension module (EX1)	28
External current transformer (ZCT/ZT)	18
F	
Field test devices	19
Front terminal adapter (FTA)	15
G	
Ground fault protection (GFR)	26
I	
I/O unit (BIF-CON/BIF-CL)	29
Interface unit (BIF-CC/BIF-PR/BIF-MD)	29
Interlock device (CYL)	14
Internal power supply unit's (PW)	19
Interphase barrier	19
M	
MCR switch (MCS-W)	27
MCR: Making current release	21
Mechanical interlock (MI)	16
Mis-insertion preventor (MIP)	15
Motor charging device (MD)	11
N	
NCT	21
Neutral current transformer (NCT)	18
Neutral pole 50% protection (N5)	27
Neutral pole overcurrent protection (NP)	21
O	
OCR alarm (AL)	21
Overview and mounting positions	10
P	
Product Introduction of Accessories	5
Product Skeleton of Accessories	4
Push button cover (BC-L)	17
S	
Safety shutters (SST)	14
Shorting b-contact (SBC)	15
Shunt trip device (SHT)	13
Specifications	6
Standard series AE-SW	9
T	
Terminal cover (TTC)	17
Test jumper (TJ)	19
Trip Coil (AL)	11
U	
Undervoltage trip device (UVT)	12
V	
Vertical terminal adapter (VTA)	15
VT-W unit	28
Z	
ZCT	21

Global Partner. Local Friend.

EUROPEAN BRANCHES

FRANCE
MITSUBISHI ELECTRIC EUROPE B.V.
25, Boulevard des Bouvets
F-92741 Nanterre Cedex
Phone: +33 (0)1 / 55 68 55 68

GERMANY
MITSUBISHI ELECTRIC EUROPE B.V.
Gothaer Straße 8
D-40880 Ratingen
Phone: +49 (0)2102 / 486-0

IRELAND
MITSUBISHI ELECTRIC EUROPE B.V.
Westgate Business Park, Ballymount
IRL-Dublin 24
Phone: +353 (0)1 4198800

ITALY
MITSUBISHI ELECTRIC EUROPE B.V.
Viale Colonna 7
I-20041 Agrate Brianza (MI)
Phone: +39 039 / 60 53 1

SPAIN
MITSUBISHI ELECTRIC EUROPE B.V.
Carretera de Rubí 76-80
E-08190 Sant Cugat del Vallés (Barcelona)
Phone: +34 93 / 565 3131

UK
MITSUBISHI ELECTRIC EUROPE B.V.
Travellers Lane
UK-Hatfield, Herts. AL10 8 XB
Phone: +44 (0)1707 / 27 61 00

EUROPEAN REPRESENTATIVES

BELARUS
TEHNIKON
Oktyabrskaya 16/5, Off.704
BY-220030 Minsk
Phone: +375 (0)17 / 210 46 26

BELGIUM
Koning & Hartman b.v.
Woluwelaan 31
BE-1800 Vilvoorde
Phone: +32 (0)2 / 257 02 40

CZECH REPUBLIC
AutoCont CS s.r.o.
Jelinkova 59/3
CZ-721 00 Ostrava Svinov
Phone: +420 (0)59 / 5691 150

CZECH REPUBLIC
B:TECH A.S.
Na Ostrove 84
CZ - 58001 Havlickov Brod
Phone: +420 (0)569 / 408 841

GREECE
ELEKTRAPOTHIKI ATTIKIS S.A.
15, Agiou Orouis
GR-10447 Athens
Phone: +30 210 / 341 6650

HUNGARY
MELTRADE Ltd.
Fertő utca 14.
HU-1107 Budapest
Phone: +36 (0)1 / 431-9726

ISRAEL
GINO Industries Ltd.
26, Ophir street
IL-32235 Haifa
Phone: +972 (0)4 / 867 06 56

KAZAKHSTAN
Kazpromautomatics Ltd.
2, Scladskaya str.
KAZ-470046 Karaganda
Phone: +7 3212 / 50 11 50

LITHUANIA
RIFAS UAB
Tinklų g. 29A
LT-5300 Panevezys
Phone: +370 (0)45 / 582 728

MOLDOVA
INTEHSIS SRL
bid. Traian 23/1
MD-2060 Kishinev
Phone: +373 (0)22 / 66 4242

NETHERLANDS
Imtech Marine & Offsh.
Sluisjesdijk 155
NL-3087 AG Rotterdam
Phone: +31 (0)10 / 487 19 11

ISRAEL
SCANELEC AS
Leirvikasen 43B
NO-5179 Godvik
Phone: +47 (0)55 / 50 60 00

POLAND
MPL Technology Sp. z o.o.
Ul. Krakowska 50
PL-32-083 Balice
Phone: +48 (0)12 / 630 47 00

ROMANIA
Sirius Trad. & Serv. srl
Aleea Lacul Morii Nr.3
RO-060841 Bucuresti, Sector 6
Phone: +40 (0)21 / 430 40 06

SERBIA
CRAFT Cons. & Engineer.d.o.o.
Toplicina str.4 lok 6
SCG-1800 Nis
Phone: +381 (0)18 / 292-24-4/5, 523 962

SLOVAKIA
AutoCont Control s.r.o.
Radlinského 47
SK-02601 Dolný Kubín
Phone: +421 (0)43 / 5868 210

SLOVAKIA
CS MTrade Slovensko, s.r.o.
Vajanskeho 58
SK - 92101 Piestany
Phone: +421 (0)33 / 7742 760

SLOVENIA
INEA d.o.o.
Stegne 11
SI-1000 Ljubljana
Phone: +386 (0)1 / 513 8100

SWEDEN
Euro Energy Components AB
Järnvägsgatan 36
SE-434 24 Kungälv
Phone: +46 (0)300 / 69 00 40

SWITZERLAND
TRIELEC AG
Mühlentalstr. 136
CH-8200 Schaffhausen
Phone: +41 (0)52 / 625 84 25

TURKEY
GTS
Darulaceze Cad.No.43 KAT.2
TR-34384 Okmeydanı-Istanbul
Phone: +90 (0)212 / 320 1640

TURKEY
CBI Ltd.
Private Bag 2016
ZA-1600 Isando
Phone: +27 (0)11 / 928 2000

RUSSIA
CONSYS
Promyshlennaya st.42
RU-198099 St. Petersburg
Phone: +7 812 / 325 36 53

UKRAINE
CSC Automation Ltd.
15, M. Raskova St., Fl.10, Office 1010
UA-02002 Kiev
Phone: +380 (0)44 / 494 33 55



Mitsubishi Electric Europe B.V. /// FA - European Business Group /// Gothaer Straße 8 /// D-40880 Ratingen /// Germany
Tel.: +49(0)2102-4860 /// Fax: +49(0)2102-4861120 /// info@mitsubishi-automation.de /// www.mitsubishi-automation.com

Specifications subject to change /// Art. no. 62093-F /// 07.2006